

AIR CONDITIONER CEILING SUSPENSION TYPE

Indoor Unit

ABU30

ABU36

Outdoor Unit

AOU30

AOU36

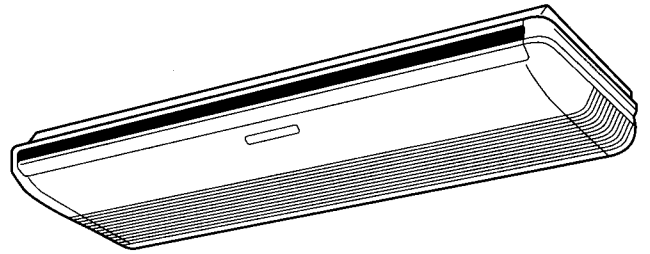



KEEP THIS OPERATION MANUAL
FOR FUTURE REFERENCE

CONTENTS

SAFETY PRECAUTIONS	2	ADJUSTING THE DIRECTION OF	
FEATURES AND FUNCTIONS	3	AIR CIRCULATION	11
NAME OF PARTS	4	SWING OPERATION	12
PREPARATION	6	ENERGY SAVE OPERATION	13
OPERATION	7	MANUAL AUTO OPERATION	13
TIMER OPERATION	9	CLEANING AND CARE	14
SLEEP TIMER OPERATION	10	TROUBLESHOOTING	15
		OPERATING TIPS	16

SAFETY PRECAUTIONS

- Before using the appliance, read these "PRECAUTIONS" thoroughly and operate in the correct way.
- The instructions in this section all relate to safety; be sure to maintain safe operating conditions.
- "DANGER", "WARNING" and "CAUTION" have the following meanings in these instructions:

 DANGER!	This mark indicates procedures which, if improperly performed, are most likely to result in the death of or serious injury to the user or service personnel.
 WARNING!	This mark indicates procedures which, if improperly performed, might lead to the death or serious injury of the user.
 CAUTION!	This mark indicates procedures which, if improperly performed, might possibly result in personal harm to the user, or damage to property.

DANGER!

- Do not attempt to install this air conditioner by yourself.
- This unit contains no user-serviceable parts. Always consult authorized service personnel for repairs.
- When moving, consult authorized service personnel for disconnection and installation of the unit.
- Do not become over-exposed to cold air by staying in the direct path of the airflow of the air conditioner for extended periods of time.
- Do not insert fingers or objects into the outlet port or intake grilles.
- Do not start and stop air conditioner operation by turning off the electrical breaker and so on.
- In the event of a malfunction (burning smell, etc.), immediately stop operation, turn off the electrical breaker, and consult authorized service personnel.

CAUTION!

- Provide occasional ventilation during use.
- Do not direct air flow at fireplaces or heating apparatus.
- Do not climb on, or place objects on, the air conditioner.
- Do not hang objects from the indoor unit.
- Do not set flower vases or water containers on top of air conditioners.
- Do not expose the air conditioner directly to water.
- Do not operate the air conditioner with wet hands.
- Turn off power source when not using the unit for extended periods.
- Always turn off the electrical breaker whenever cleaning the air conditioner or changing the air filter.
- Connection valves become hot during Heating; handle with care.
- Check the condition of the installation stand for damage.
- Do not place animals or plants in the direct path of the air flow.
- When restarting after a long period of disuse in the winter: turn the power switch on at least 12 hours before starting the unit.
- Do not drink the water drained from the air conditioner.
- Do not use in applications involving the storage of foods, plants or animals, precision equipment, or art works.
- Do not apply any heavy pressure to radiator fins.
- Operate only with air filters installed.
- Do not block or cover the intake grille and outlet port.
- Ensure that any electronic equipment is at least one meter away from either the indoor or outdoor units.
- Avoid installing the air conditioner near a fireplace or other heating apparatus.
- When installing the indoor and outdoor unit, take precautions to prevent access to infants.
- Do not use inflammable gases near the air conditioner.

FEATURES AND FUNCTIONS

AUTOMATIC OPERATION

● COOLING MODEL

Merely press the START/STOP button, and the unit will begin automatic operation in the Cooling or Dry mode as appropriate, in accordance with the thermostat setting and the actual temperature of the room.

● HEAT & COOL MODEL (REVERSE CYCLE)

Merely press the START/STOP button, and the unit will begin automatic operation in either the Heating, Cooling or Monitor modes as appropriate, in accordance with the thermostat setting and the actual temperature of the room.

SLEEP TIMER

● COOLING MODEL

When the SLEEP timer button is pressed during Cooling or Dry mode, the thermostat setting is gradually raised during the period of operation. When the set time is reached, the unit automatically turns off.

● HEAT & COOL MODEL (REVERSE CYCLE)

When the SLEEP timer button is pressed during Heating mode, the air conditioner's thermostat setting is gradually lowered during the period of operation; during Cooling or Dry mode, the thermostat setting is gradually raised during the period of operation. When the set time is reached, the unit automatically turns off.

WIRELESS REMOTE CONTROL UNIT

The WIRELESS REMOTE CONTROL UNIT allows convenient control of air conditioner operation.

OMNI-DIRECTIONAL AIR FLOW (SWING OPERATION)

Three-dimensional control over air direction swing is possible through dual use of both an UP/DOWN air direction swing and RIGHT/LEFT air direction swing. Since UP/DOWN air direction flaps operate automatically according to the operating mode of the unit, it is possible to set air direction based on the operating mode.

MILDEW-RESISTANT FILTER

The AIR FILTER has been treated to resist mildew growth, thus allowing cleaner use and easier care.

NAME OF PARTS

Instructions relating to heating(*) are applicable only to "HEAT & COOL MODEL" (Reverse Cycle).

Fig. 1

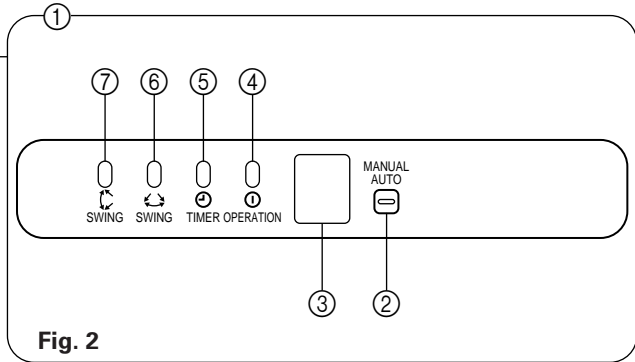
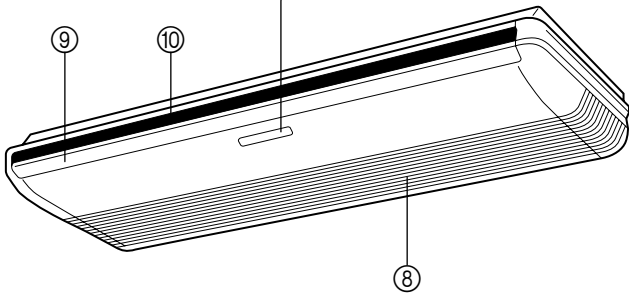
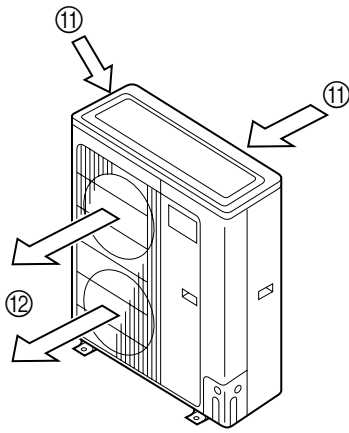
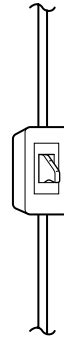

Fig. 4



Electrical Breaker



This breaker is installed during the electrical installation.

Fig. 3

Fig. 5

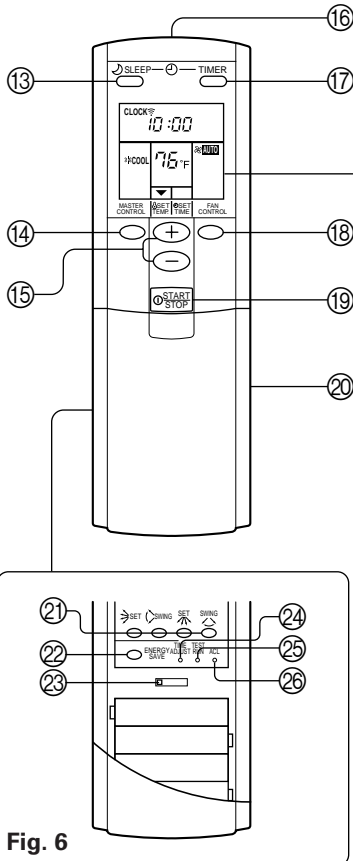

Fig. 6

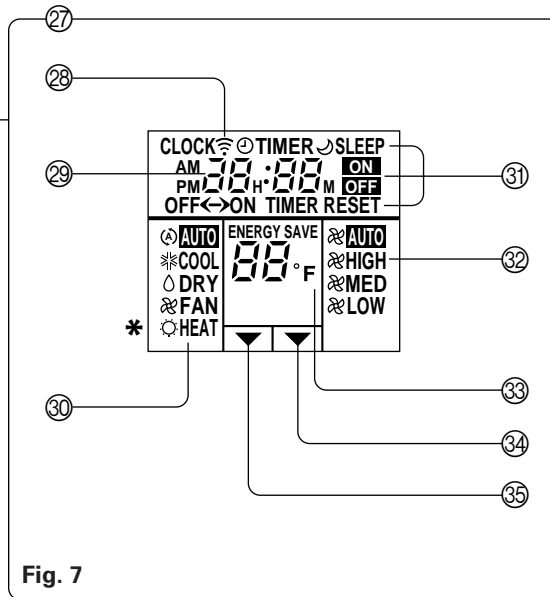

Fig. 7

Fig. 1 Indoor Unit

- ① Operating Control Panel (Fig. 2)
- ② MANUAL AUTO button
- ③ Remote Control Signal Receiver
- ④ OPERATION Indicator Light (red)
- ⑤ TIMER Indicator Light (green)
- ⑥ SWING Indicator Light (orange)
(HORIZONTAL SWING)
- ⑦ SWING Indicator Light (orange)
(VERTICAL SWING)
 - If the TIMER indicator light flashes when the timer is operating, it indicates that a fault has occurred with the timer setting (See Page 17 Auto Restart).
- ⑧ Intake Grille
- ⑨ UP/DOWN Air Direction Flap
- ⑩ RIGHT/LEFT Air Direction Louvers
(behind UP/DOWN Air Direction Flap)

Fig. 4 Outdoor Unit

- ⑪ Intake side
- ⑫ Outlet side

Fig. 5 Remote Control Unit

- ⑬ SLEEP Button
- ⑭ MASTER CONTROL Button
- ⑮ SET TEMP./SET TIME Buttons (⊕/⊖)
- ⑯ Signal Transmitter
- ⑰ TIMER Button
- ⑱ FAN CONTROL Button
- ⑲ START/STOP Button
- ⑳ Battery compartment lid

Inside of the battery compartment lid (Fig. 6)

- ㉑ AIR FLOW DIRECTION Button
- ㉒ ENERGY SAVE Button
- ㉓ CODE CHANGE (Slide Switch)
Switching the remote control unit code.
(Max. 4 units)
- ㉔ TIME ADJUST Button
- ㉕ TEST RUN Button
 - This button is used when installing the air conditioner and should not be used under normal conditions as it will cause the air conditioner's thermostat function to operate incorrectly.
 - If this button is pressed during normal operation, the unit will switch to test operation mode, and the indoor unit's OPERATION indicator light and TIMER indicator light will flash simultaneously.
 - To stop the test operation mode, either press the TEST RUN button once again, or press the START/STOP button to stop the air conditioner.
- ㉖ ACL Button

㉗ Remote Control Unit Display (Fig. 7)

- ㉘ Transmit Indicator
- ㉙ Clock Display
- ㉚ Operating Mode Display
- ㉛ Timer Mode Display
- ㉜ Fan Speed Display
- ㉝ Temperature Set Display
- ㉞ Timer Set Indicator
- ㉟ Temperature Set Indicator

PREPARATION

Load Batteries (R03/LR03/AAA×4)

- 1 Press and slide the battery compartment lid to open it.
- 2 Insert batteries.
Be sure to align the battery polarities (⊕/⊖) correctly.
- 3 Close the battery compartment lid.

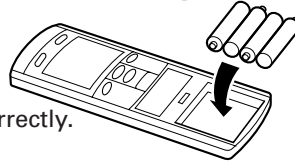

⚠ CAUTION!

- Take care to prevent infants from accidentally swallowing batteries.
- When not using the remote control unit for an extended period, remove the batteries to avoid possible leakage and damage to the unit.
- If leaking battery fluid comes in contact with your skin, eyes, or mouth, immediately wash with copious amounts of water, and consult your physician.
- Dead batteries should be removed immediately and disposed of properly, either in a battery collection receptacle or to the appropriate authority.
- Do not attempt to recharge dry batteries.

Set the Current time

- 1 Press the TIME ADJUST button.
Use the tip of a ball-point pen or other small object to press the button.
- 2 Use the (⊕/⊖)SET TIME buttons to adjust the clock to the current time.
 - ⊕ button: Press to advance the time.
 - ⊖ button: Press to reverse the time.
 (Each time the buttons are pressed, the time will be advanced/reversed in one-minute increments; hold the buttons depressed to change the time quickly in ten-minute increments.)
- 3 Press the TIME ADJUST button again.
This completes the time setting and starts the clock.

Never mix new and used batteries, or batteries of different types. Batteries should last about one year under normal use. If the remote control unit's operating range becomes appreciably reduced, replace the batteries and press the ACL button with the tip of a ballpoint pen or other small object.

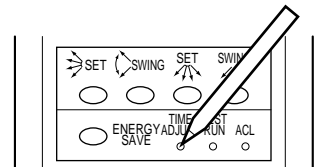

To Use the Remote Control Unit

- The remote control unit must be pointed at signal receiver to operate correctly.
- Maximum operating range: Approximately 10 meters. (This may not apply when the battery is low or there is an obstacle.)
- When a signal is properly received by the air conditioner, a beep will be heard.
- If no beep is heard, press the remote control unit button again.

Remote Control Unit Holder

For Hand Held Use

- ① Mount the Holder.
- ② Set the Remote Control Unit.
- ③ To remove the Remote Control Unit.

For Wall Mount Use

- ① Mount the Holder.
- ② Set the Remote Control Unit.
- ③ Attach the unit to the holder as shown.

OPERATION

Instructions relating to heating (*) are applicable only to "HEAT & COOL MODEL" (Reverse Cycle).

To Select Mode Operation

- 1 Press the START/STOP button.**
The indoor unit's OPERATION indicator light (red) will be on.
The air conditioner will start operating.
- 2 Press the MASTER CONTROL button to select the desired mode.**
Each time the button is pressed, the mode will change in the following order.



About three seconds later, the entire display will reappear.

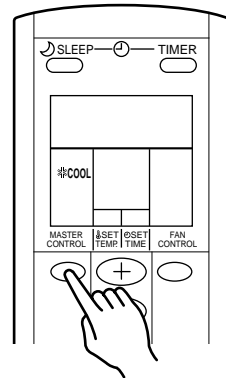

Example: When set to COOL

To Set the Thermostat

Press the SET TEMP. buttons.

- + button:** Press to raise the thermostat setting.
- button:** Press to lower the thermostat setting.

●Thermostat setting range:

AUTO	64 to 88 °F
* Heating	60 to 88 °F
Cooling/Dry	64 to 88 °F

The thermostat cannot be used to set room temperature during the FAN mode (the temperature will not appear on the remote control unit's display).

About three seconds later, the entire display will reappear.

The thermostat setting should be considered a standard value, and may differ somewhat from the actual room temperature.

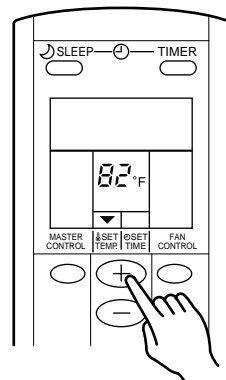

Example: When set to 82 °F

To Set the Fan Speed

Press the FAN CONTROL button.

Each time the button is pressed, the fan speed changes in the following order:

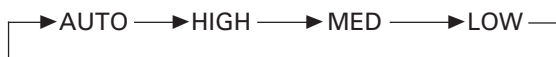

About three seconds later, the entire display will reappear.

When set to AUTO:

- * Heating :** Fan operates so as to optimally circulate warm air.
However, the fan will operate at very low speed when the temperature of the air from the indoor unit is low.
- Cooling :** As the room temperature approaches that of the thermostat setting, the fan speed becomes slower.
- Fan :** The fan alternately turns on and off; when on, the fan runs at the low fan speed.

The fan will operate at a very low setting during Monitor operation and at the start of the Heating mode.

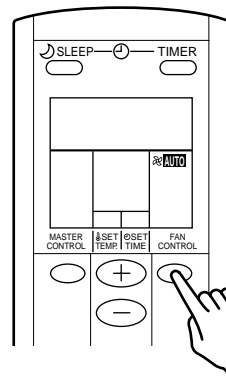

Example: When set to AUTO

To Stop Operation

Press the START/STOP button.

The OPERATION indicator light (red) will turn off.

OPERATION

Instructions relating to heating (*) are applicable only to "HEAT & COOL MODEL" (Reverse Cycle).

About Mode Operation

AUTO:

COOLING MODEL

- When the room temperature is 4 °F higher than the set temperature, the mode will switch between Cooling and Drying.
- During the Drying mode operation, the FAN setting should be switched to LOW for a gently cooling effect during which the fan may temporarily stop rotating.
- If the mode automatically selected by the unit is not satisfactory, see page 7 for instructions on changing the mode setting (COOL, DRY, FAN).

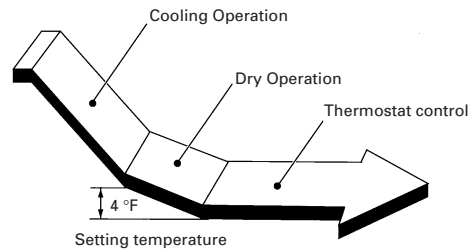

AUTO (* AUTO CHANGEOVER):

HEAT & COOL MODEL (Reverse cycle)

- When AUTO CHANGEOVER is selected, the air conditioner selects the appropriate operation mode (Cooling or Heating) according to your room's present temperature.
- When AUTO CHANGEOVER is first selected, the fan will operate at very low speed for about one minute while the unit determines the current conditions of the room and accordingly selects the proper operation mode.
- When the air conditioner has adjusted your room's temperature to near the thermostat setting, it will begin monitor operation. In the monitor operation mode, the fan will operate at low speed. If the room temperature subsequently changes, the air conditioner will once again select the appropriate operation (Heating, Cooling) to adjust the temperature to the value set in the thermostat. (The monitor operation range is ± 4 °F relative to the thermostat setting.)
- If the mode automatically selected by the unit is not satisfactory, see page 7 for instructions on changing the mode setting (HEAT, COOL, DRY, FAN).

*Heating:

- Use to warm your room.
- When Heating mode is selected, the air conditioner will operate at very low fan speed for about 3 to 5 minutes, after which it will switch to the selected fan setting. This period of time is provided to allow the indoor unit to warm up before begin full operation.
- When the room temperature is very low, frost may form on the outside unit, and its performance may be reduced. In order to remove such frost, the unit will automatically enter the defrost cycle from time to time. During Automatic Defrosting operation, the OPERATION indicator light (red) will flash, and the heat operation will be interrupted.

Cooling:

- Use to cool your room.

Dry:

- Use for gently cooling while dehumidifying your room.
- You cannot heat the room during Dry mode.
- During Dry mode, the unit will operate at low speed; in order to adjust room humidity, the indoor unit's fan may stop from time to time. Also, the fan may operate at very low speed when detecting room humidity.
- The fan speed cannot be changed manually when Dry mode has been selected.

Fan:

- Use to circulate the air throughout your room.

* During Heating mode:

Set the thermostat to a temperature setting that is higher than the current room temperature. The Heating mode will not operate if the thermostat is set lower than the actual room temperature.

During Cooling/Dry mode:

Set the thermostat to a temperature setting that is lower than the current room temperature. The Cooling and Dry modes will not operate if the thermostat is set higher than the actual room temperature (in Cooling mode, the fan alone will operate).

During Fan mode:

The heat and cool functions of this unit cannot operate in the Fan mode.

TIMER OPERATION

Instructions relating to heating (*) are applicable only to "HEAT & COOL MODEL" (Reverse Cycle).

Before using the timer function, be sure that the remote control unit is set to the current time (See page 6).

To Use the ON timer or OFF timer

1 Press the START/STOP button
(if the unit is already operating, proceed to step 2).
The indoor unit's OPERATION indicator light (red) will turn on.

2 Press the TIMER button to select the OFF timer or ON timer operation.

Each time the button is pressed the timer function changes in the following order:

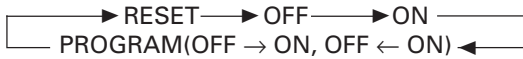

The indoor unit's TIMER indicator light (green) will turn on.

3 Use the SET TIME buttons to adjust the desired OFF time or ON time.

Set the time while the time display is flashing (the flashing will continue for about five seconds).

+ button: Press to advance the time.

- button: Press to reverse the time.

About five seconds later, the entire display will reappear.

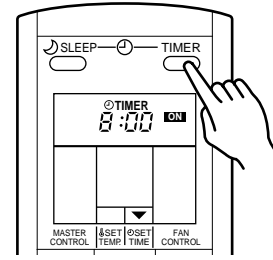

To Cancel the Timer

Use the TIMER button to select "TIMER RESET."

The air conditioner will return to normal operation.

To Change the Timer Settings

Perform steps 2 and 3.

To Stop Air Conditioner Operation while the Timer is Operating

Press the START/STOP button.

To Change Operating Conditions

If you wish to change the operating conditions (Mode, Fan Speed, Thermostat Setting), after making the timer setting, wait until the entire display reappears, then press the appropriate buttons to change to the desired operating condition.

To Use the PROGRAM timer

1 Press the START/STOP button
(if the unit is already operating, proceed to step 2).
The indoor unit's OPERATION indicator light (red) will turn on.

2 Set the desired times for OFF timer and ON timer.

See the section "To Use the ON timer or OFF timer" to set the desired mode and times.

About five seconds later, the entire display will reappear.

The indoor unit's TIMER indicator light (green) will turn on.

3 Press the TIMER button to select the PROGRAM timer operation (either OFF → ON or OFF ← ON will display).

The display will alternately show "OFF timer" and "ON timer", then change to show the time setting for the operation to occur first.

● The PROGRAM timer will begin operation. (If the ON timer has been selected to operate first, the unit will stop operating at this point.)

About five seconds later, the entire display will reappear.

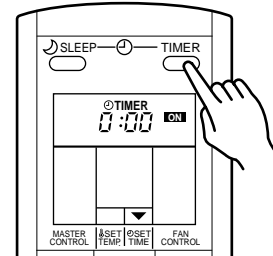

To Cancel the Timer

Use the TIMER button to select "TIMER RESET."

The air conditioner will return to normal operation.

To Change the Timer Settings

1. Follow the instructions given in the section "To Use the ON Timer or OFF Timer" to select the timer setting you wish to change.
2. Press the TIMER button to select either OFF → ON or OFF ← ON.

To Stop Air Conditioner Operation while the Timer is Operating

Press the START/STOP button.

To Change Operating Conditions

If you wish to change the operating conditions (Mode, Fan Speed, Thermostat Setting), after making the timer setting, wait until the entire display reappears, then press the appropriate buttons to change to the desired operating condition.

TIMER OPERATION

About the PROGRAM timer

- The PROGRAM timer allows you to integrate OFF timer and ON timer operations in a single sequence. The sequence can involve one transition from OFF timer to ON timer, or from ON timer to OFF timer, within a twenty-four hour period.
- The first timer function to operate will be the one set nearest to the current time. The order of operation is indicated by the arrow in the remote control unit's display (OFF → ON, or OFF ← ON).
- One example of PROGRAM timer use might be to have the air conditioner automatically stop (OFF timer) after you go to sleep, then start (ON timer) automatically in the morning before you rise.

About the ON timer

- The timer function is designed to bring your room to a comfortable temperature by the set time; as a result, the unit automatically begins operation before the set time so that the room reaches the desired temperature by the time set on the timer.
- The hotter it is in summer, or the colder it is in winter, the earlier that operation will begin.
- * During Heating Operation from 45 to 10 minutes before set time.
- During Cooling/Dry Operation ... from 20 to 10 minutes before set time.
- During Fan Operation at the set time.

SLEEP TIMER OPERATION

Instructions relating to heating (*) are applicable only to "HEAT & COOL MODEL" (Reverse Cycle).

Unlike other timer functions, the SLEEP timer is designed to set the duration of time in which the unit does not operate.

To Use the SLEEP timer

While the air conditioner is operating or stopped, press the SLEEP button.

Both the indoor unit's OPERATION indicator light (red) and the TIMER indicator light (green) will turn on.

To Change the Timer Settings

Press the SLEEP button once again and set the time using the SET TIME buttons.

Set the time while the Timer Mode Display is flashing (the flashing will continue for about five seconds).

- ⊕ button: Press to advance the time.
- ⊖ button: Press to reverse the time.

About five seconds later, the entire display will reappear.

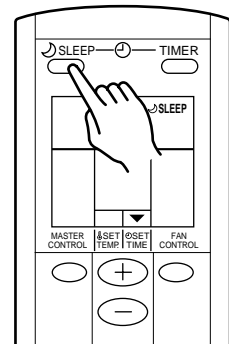

To Cancel the Timer:

Use the TIMER button to select "TIMER RESET". The air conditioner will return to normal operation.

To Stop the Air Conditioner During Timer Operation:

Press the START/STOP button.

About the SLEEP timer

To prevent excessive heating or cooling during sleep, the SLEEP timer function automatically modifies the thermostat setting in accordance with the time setting. When the set time has elapsed, the air conditioner completely stops.

*During Heating operation:

When the SLEEP timer is set, the thermostat setting is automatically lowered 2 °F every thirty minutes. When the thermostat has been lowered a total of 8 °F, the thermostat setting at that time is maintained until the set time has elapsed, at which time the air conditioner automatically turns off.

SLEEP timer setting

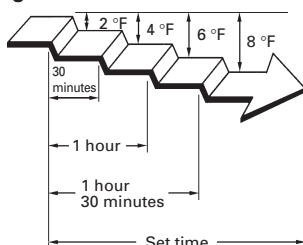

During Cooling/Dry operation:

When the SLEEP timer is set, the thermostat setting is automatically raised 2 °F every sixty minutes. When the thermostat has been raised a total of 4 °F, the thermostat setting at that time is maintained until the set time has elapsed, at which time the air conditioner automatically turns off.

SLEEP timer setting

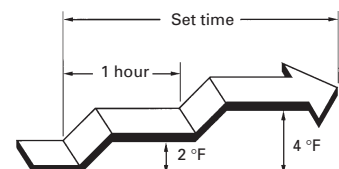

ADJUSTING THE DIRECTION OF AIR CIRCULATION

Instructions relating to heating (*) are applicable only to "HEAT & COOL MODEL" (Reverse Cycle).

Vertical (up-down) direction of airflow is adjusted by pressing the remote control unit's AIR FLOW DIRECTION VERTICAL SET button. Horizontal (right-left) direction of airflow is adjusted by pressing the remote control unit's AIR FLOW DIRECTION HORIZONTAL SET button.

Vertical Air Direction Adjustment

Press the AIR FLOW DIRECTION VERTICAL SET button .

Each time the button is pressed, the air direction range will change as follows:



Types of Air flow Direction Setting:

①,②,③ : During Cooling/Dry Modes

①,②,③,④,⑤: *During Heating mode

The remote control unit's display does not change.

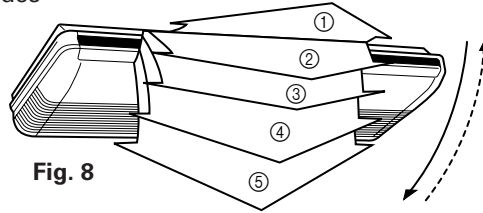

Fig. 8

- Use the air direction adjustments within the ranges shown above.
- The vertical airflow direction is set automatically as shown, in accordance with the type of operation selected.
 - Horizontal flow ① : During Cooling/Dry mode
 - Downward flow ⑤ : * During Heating mode
- During AUTO mode operation, for the first minute after beginning operation, airflow will be horizontal ①; the air direction cannot be adjusted during this period.

⚠ DANGER!

Never place fingers or foreign objects inside the outlet port could cause personal injury.

- Always use the remote control unit's AIR FLOW DIRECTION button to adjust the UP/DOWN air direction flap or RIGHT/LEFT air direction louvers. Attempting to move them manually could result in improper operation; in this case, stop operation and restart. The louvers should begin to operate properly again.
- During use of the Cooling and Dry modes, do not set the UP/DOWN air direction flap in the range ④ to ⑤ for long periods of time, since water vapor may condense near the outlet port and drops of water may drip from the air conditioner.
- When used in a room with infants, children, elderly or sick persons, the air direction and room temperature should be considered carefully when adjusting settings.

Horizontal Air Direction Adjustment

Press the AIR FLOW DIRECTION HORIZONTAL SET button .

Each time the button is pressed, the air direction range will change as follows:



The remote control unit's display does not change.

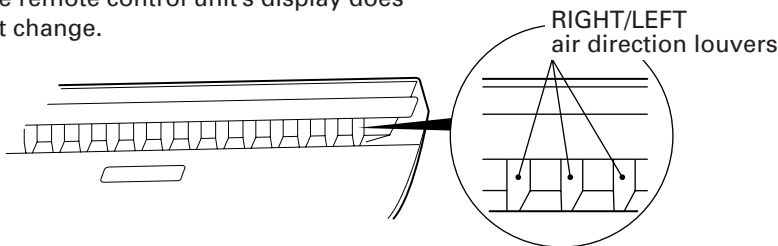

- Use the air direction adjustments within the ranges shown above.

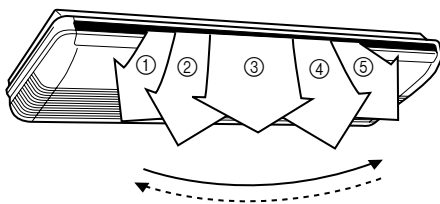
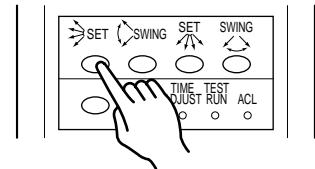
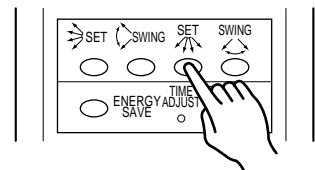

Fig. 9



Example: When set to vertical air direction



Example: When set to horizontal air direction

SWING OPERATION

Begin air conditioner operation before performing this procedure

To select Vertical airflow SWING Operation

Press the AIR FLOW DIRECTION VERTICAL SWING button .

The SWING indicator light (VERTICAL SWING) (orange) will turn on.
In this mode, the UP/DOWN air direction flap will swing automatically to direct the air flow both up and down.

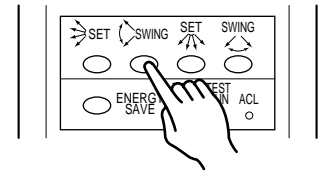

Example: When set to vertical swing

To Stop Vertical airflow SWING Operation

Press the AIR FLOW DIRECTION VERTICAL SWING button once again.

The SWING indicator light (VERTICAL SWING) will turn off.
Airflow direction will return to the setting before swing was begun.

About Vertical Airflow Swing Operation

- The range of swing is relative to the currently set airflow direction.

Air flow direction set	Range of swing
①	① to ③
②	① to ③
③	② to ④
④	③ to ⑤
⑤	① to ⑤ (All range)

Air direction range (See page 11, Fig. 8)

- If the swing range is not as desired, use the remote control unit's AIR FLOW DIRECTION VERTICAL SET button to change the range of swing.
- The SWING operation may stop temporarily when the air conditioner's fan is not operating, or when operating at very low speeds.
- During use of the Cooling and Dry modes, do not set the air UP/DOWN direction flap, in the Heating range (④ to ⑤) for long periods of time, since water vapor may condense near the outlet port and drops of water may drip from the air conditioner.

To select Horizontal Airflow SWING Operation

Press the AIR FLOW DIRECTION HORIZONTAL SWING button.

The SWING indicator light (HORIZONTAL SWING) (orange) will turn on.
In this mode, the RIGHT/LEFT air direction louvers will swing automatically to direct the airflow both right and left.

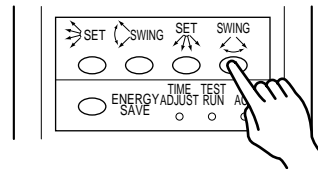

Example: When set to horizontal swing

To Stop Horizontal airflow SWING Operation

Press the AIR FLOW DIRECTION HORIZONTAL SWING button once again.

The SWING indicator light (HORIZONTAL SWING) will turn off.
Airflow direction will return to the setting before swing was begun.

About Horizontal Airflow Swing Operation

- The range of swing is relative to the currently set airflow direction.

Air flow direction set	Range of swing
①	① to ⑤ (All range)
②	① to ③
③	② to ④
④	③ to ⑤
⑤	① to ⑤ (All range)

Air direction range (See page 11, Fig.9)

- If the swing range is not as desired, use the remote control unit's AIR FLOW DIRECTION HORIZONTAL SET button to change the range of swing.
- The SWING operation may stop temporarily when the air conditioner's fan is not operating, or when operating at very low speeds.

ENERGY SAVE OPERATION

Instructions relating to heating (*) are applicable only to "HEAT & COOL MODEL" (Reverse Cycle).
The air conditioner can be operated while keeping energy consumption costs down.

How To Use the ENERGY SAVE OPERATION

- 1 Press the START/STOP button (if the unit is already operating, proceed to step 2).**
The indoor unit's OPERATION indicator light (red) will turn on.
- 2 Press the MASTER CONTROL button to select the COOL, DRY, *HEAT mode.**
- 3 Press the ENERGY SAVE button.**
ENERGY SAVE can only be used if the MASTER CONTROL button is used to select the "COOL", "DRY" or "*HEAT".

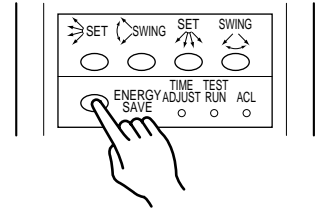

To Cancel the ENERGY SAVE:
Press the ENERGY SAVE button.

About the ENERGY SAVE

The air conditioner saves energy costs by controlling the thermostat temperature setting.

*During Heating operation:

The thermostat temperature setting decreases by 2 °F as soon as the ENERGY SAVE button is pressed, and then decreases by another 2 °F every thirty minutes. In this manner, energy is saved by continuing to heat at a thermostat temperature of 8 °F less than the setting.

During Cooling/Dry operation:

The thermostat temperature setting increases by 2 °F as soon as the ENERGY SAVE button is pressed, and then increases by another 2 °F after one hour has passed. In this manner, energy is saved by continuing to cool or dry at a thermostat temperature of 4 °F more than the setting.

ENERGY SAVE setting

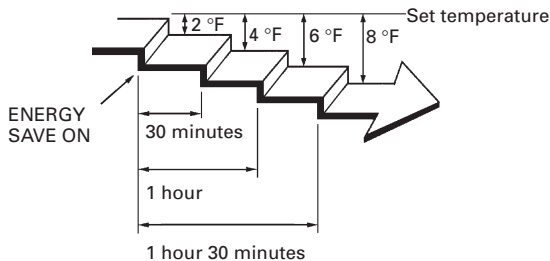

ENERGY SAVE setting

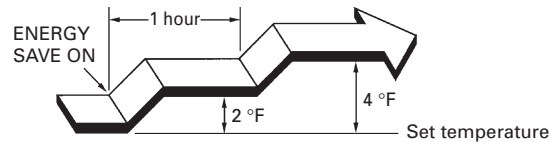

MANUAL AUTO OPERATION

Use the MANUAL AUTO operation in the event the remote control unit is lost or otherwise unavailable.

How To Use the Main Unit Controls

Press the MANUAL AUTO button on the main unit operating control panel.

To stop operation, press the MANUAL AUTO button once again.

⚠ CAUTION!

Do not press the MANUAL AUTO button with wet hands or pointed objects, otherwise an electric shock or malfunction may occur.

- When the air conditioner is operated with the controls on the Main unit, it will operate under the same mode as the AUTO mode selected on the remote control unit (see page 8).
- The fan speed selected will be "AUTO" and the thermostat setting will be 73 °F.

CLEANING AND CARE

CAUTION!

- Before cleaning the air conditioner, be sure to turn it off and disconnect the power supply.
- Turn off the electrical breaker.

Cleaning the Air Filter

1. Pull the air filters upward to remove them.

Remove the air filters by raising its handle while pulling it out towards you.

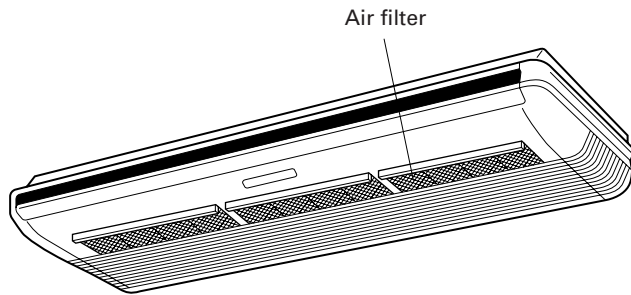

2. Clean the air filters.

Remove the dust from the air filters by vacuuming or washing them. After washing, allow the air filters to dry thoroughly in an area protected from sunlight.

3. Re-attach the air filters to the intake grille.

The air filters fit onto the inside of the intake grille.

- Dust can be cleaned from the air filter either with a vacuum cleaner, or by washing the filter in a solution of mild detergent and warm water. If you wash the filter, be sure to allow it to dry thoroughly in a shady place before re-installing.
- If dirt is allowed to accumulate on the air filter, air flow will be reduced, lowering operating efficiency and increasing noise.
- During periods of normal use, the air filters should be cleaned every four weeks.

- When used for extended periods, the unit may accumulate dirt inside, reducing its performance. We recommend that the unit be inspected regularly, in addition to your own cleaning and care. For more information, consult authorized service personnel.
- When cleaning the unit's body, do not use water hotter than 100 °F, harsh abrasive cleansers, or volatile agents like benzene or thinner.
- Do not expose the unit body to liquid insecticides or hairsprays.
- If the unit will not be operated for a period of one month or more, be sure to allow the inner parts of the unit to dry thoroughly, in advance, by operating the unit in fan mode for half a day.

TROUBLESHOOTING

Instructions relating to heating (*) are applicable only to "HEAT & COOL MODEL" (Reverse Cycle).



In the event of a malfunction (burning smell, etc.), immediately stop operation, turn off the electrical breaker, and consult authorized service personnel.

Merely turning off the unit's power switch will not completely disconnect the unit from the power source. Always be sure to turn off the electrical breaker to ensure that power is completely off.

Before requesting service, perform the following checks:

	Symptom	Problem	See Page
NORMAL FUNCTION	Doesn't operate immediately:	<ul style="list-style-type: none"> ● If the unit is stopped and then immediately started again, the compressor will not operate for about 3 minutes, in order to prevent fuse blowouts. ● Whenever the power switch is turned off then on again, the protection circuit will operate for about 3 minutes, preventing unit operation during that period. 	—
	Noise is heard:	<ul style="list-style-type: none"> ● During operation and immediately after stopping the unit, the sound of water flowing in the air conditioner's piping may be heard. Also, noise may be particularly noticeable for about 2 to 3 minutes after starting operation (sound of coolant flowing). ● During operation, a slight squeaking sound may be heard. This is the result of minute expansion and contraction of the front cover due to temperature changes. 	—
		*● During Heating operation, a swoosh sound may be heard occasionally. This sound is produced by the Automatic Defrosting operation.	16
	Odor:	<ul style="list-style-type: none"> ● Occasionally an odor may be emitted from the indoor unit. This may be the result of room odor (furniture, tobacco, etc.) which have been taken into the air conditioner. 	—
	Mist or steam are emitted:	<ul style="list-style-type: none"> ● During Cooling or Dry operation, a thin mist may be seen emitted from the indoor unit. This results from the sudden Cooling of room air by the air emitted from the air conditioner, resulting in condensation and misting. 	—
		*● During Heating operation, the outdoor unit's fan may stop, and steam may be seen rising from the unit. This is due to Automatic Defrosting operation.	16
	Airflow is weak or stops:	*● When Heating operation is started, fan speed is temporarily very low, to allow internal parts to warm up.	—
		*● During Heating operation, if the room temperature rises above the thermostat setting, the outdoor unit will stop, and the indoor unit will operate at very low fan speed. If you wish to warm the room further, set the thermostat for a higher setting.	
		*● During Heating operation, the unit will temporarily stop operation (between 7 and 15 minutes) as the Automatic Defrosting mode operates. During Automatic Defrosting operation, the OPERATION indicator light will flash.	16
		● The fan may operate at very low speed during Dry operation or when the unit is monitoring the room's temperature.	7
● In the monitor AUTO operation, the fan will operate at very low speed.		7	
Water is produced from the outdoor unit:	*● During Heating operation, water may be produced by the outdoor unit due to Automatic Defrosting operation.	16	

TROUBLESHOOTING

Instructions relating to heating (*) are applicable only to "HEAT & COOL MODEL" (Reverse Cycle).

	Symptom	Items to check	See Page
CHECK ONCE MORE	Doesn't operate at all:	<ul style="list-style-type: none"> ● Is the power supply plug disconnected from its outlet? ● Has there been a power failure? ● Has a fuse blown out, or a circuit breaker been tripped? 	—
		<ul style="list-style-type: none"> ● Is the timer operating? 	9 to 10
	Poor Cooling (or *Heating) performance:	<ul style="list-style-type: none"> ● Is the air filter dirty? ● Is the air conditioner's intake grille or outlet port blocked? ● Did you adjust the room temperature settings (thermostat) correctly? ● Is there a window or door open? ● In the case of Cooling operation, is a window allowing bright sunlight to enter? (Close the curtains.) ● In the case of Cooling operation, are there heating apparatus and computers inside the room, or are there too many people in the room? 	—
	The unit operates differently from the remote control unit's setting:	<ul style="list-style-type: none"> ● Are the remote control unit's batteries dead? ● Are the remote control unit's batteries loaded properly? 	6

If the problem persists after performing these checks, or if you notice burning smells, or the TIMER indicator light flashes, stop operation immediately, disconnect the power supply, and consult with authorized service personnel.

OPERATING TIPS

Instructions relating to heating (*) are applicable only to "HEAT & COOL MODEL" (Reverse Cycle).

Operation and Performance

*Heating Performance

- This air conditioner operates on the heat-pump principle, absorbing heat from outdoor air and transferring that heat indoors. As a result, the operating performance is reduced as outdoor air temperature drops. If you feel that insufficient heating performance is being produced, we recommend you use this air conditioner in conjunction with another kind of heating appliance.
- Heat-pump air conditioners heat your entire room by recirculating air throughout the room, with the result that some time may be required after first starting the air conditioner until the room is properly heated.

*When Indoor and Outdoor Temperature are High

- When both indoor and outdoor temperatures are high during use of the heating mode, the outdoor unit's fan may stop at times.

*Microcomputer-controlled Automatic Defrosting

- When using the Heating mode under conditions of low outdoor temperature and high humidity, frost may form on the outdoor unit, resulting in reduced operating performance.

In order to minimize this kind of reduced performance, this unit is equipped with a Microcomputer-controlled Automatic Defrosting function. If excessive frost forms, the air conditioner will temporarily stop, and the defrosting circuit will operate briefly (for about 4 to 15 minutes).

During Automatic Defrosting operation, the OPERATION indicator light (red) will flash.

Low Ambient Cooling

- When the outdoor temperature drops, the outdoor unit's one of the fans may stop intermittently.

OPERATING TIPS

AUTO Restart

In Event of Power Interruption

- Should the power supply to the air conditioner be interrupted by a power failure, the air conditioner will restart automatically in the previously selected mode once the power is restored.
- Should a power failure occur during TIMER operation, the timer will be reset and the unit will begin (or stop) operating under the new timer setting. In this event, the TIMER indicator light (green) will flash (see page 5).
- Use of other electrical appliances (electric shaver, etc.) or nearby use of a wireless radio transmitter may cause the air conditioner to malfunction. In this event, temporarily disconnect the power supply, reconnect it, and then use the remote control unit to resume operation.

Temperature and Humidity Range

		Cooling/Dry Mode	*Heating Mode
Outdoor temperature	COOLING MODEL	About 32 to 115 °F	—
	HEAT & COOL MODEL (Reverse Cycle)	About 32 to 115 °F	About 32 to 75 °F
Indoor temperature		About 65 to 90 °F	About 86 °F or less
Indoor humidity		About 80 % or less If the unit is used for long periods under high-humidity conditions, condensation may form on the surface of the indoor unit, and drip onto the floor or other objects underneath.	—

- If the air conditioner is operated under higher temperature conditions than those listed, the built-in protection circuit may operate to prevent internal circuit damage. Also, during Cooling and Dry modes, if the unit is used under conditions of lower temperatures than those listed above, the heat-exchanger may freeze, leading to water leakage and other damage.
- The operation is not guaranteed under the condition where the fan blade is not rotating, or blocked by ice. If the temperature is below 32 °F, the optional separate device may be required.
- Do not use this unit for any purposes other than the Cooling, (*)Heating, Dehumidifying, and air-circulation of rooms in ordinary dwellings.



FUJITSU GENERAL AMERICA, INC.
353 ROUTE 46W • FAIRFIELD, NEW JERSEY 07004