

The Source for Bar Coding and RFID Solutions



Monarch[®]
Products and Services



Monarch

Contents

Company Overview	1
9825 Tabletop Bar Code Printer	2
9855 Tabletop Bar Code Printer	2
9860 Tabletop Bar Code Ticketing System	3
9855® RFID Solutions	4
RFID Supplies Solutions	5
9800® In-stock Supplies for 9800 Printer	6
SG & Avery Dennison Attachers	10
Specialty Attachers	11
9854	12
9864	13
6032	14
6039	15
9416®XL	16
Portable Printers	17
Monarch Supplies for Zebra and Other Printers	18
Monarch Ribbons for Zebra and Other Printers	21
Monarch Off-line Solutions	22
Mobile Work Stations	23
Labels and Tags for Laser/Inkjet Printers	24
Network Solutions	26
System Integration Service	27
Monarch® Q Service®	28
Supplies Technology Laboratory	IBC
Special Offer: Ultra® Silver 6032™ Printer Package	IBC

IFC = Inside Front Cover
IBC = Inside Back Cover

Company Overview

Avery Dennison

We are a \$6 billion company serving hundreds of thousands of customers worldwide. We are the acknowledged retail and apparel manufacturing industry leader with over 100 years of experience providing market-proven innovation and excellence. With 33,000 employees in approximately 50 countries, Avery Dennison can meet the requirements of any business, from local to global. The Printer Systems Division of Avery Dennison is the original manufacturer of Monarch products, the leader in the retail industry for over 100 years.

Consistently Outstanding Quality

Avery Dennison designs its products to last. Monarch manufacturing facilities at Miamisburg, Ohio are ISO 9001 certified, ensuring consistently excellent quality. Our plant was recognized by Industry Week in 2000 as one of the Top 10 plants in America across all industries.

Exceptional Service Worldwide

Avery Dennison has the most extensive service organization in the industry, a factory-direct service force over 100 strong in North America alone.

Innovative Technology

Monarch product innovations over the years have included the first retail pin-ticketing machine (1890), one of the earliest bar codes (Codabar, 1971) and the first battery-operated handheld bar code printer (1984). Our history of innovation continues with our RFID printer/encoders of Smart Labels. When your business can benefit from RFID, Avery Dennison can guide you.

We Stand Behind Our Products

Your purchase of Monarch products from Avery Dennison is risk-free. Return any standard item within 30 days, for any reason, and receive a full refund. (Custom supplies and custom machines may be returned if Avery Dennison was in error in filling the order). In general, machines and equipment are warranted to be free from defects in materials and workmanship for one year. Supplies and accessories are warranted for 90 days and are guaranteed to operate in any properly functioning Monarch machine for which they were designed. The applicable written warranty is available upon request.

How to Order

Call **1-800-543-6650**, prompt 5, between 8 a.m. and 5 p.m. Eastern time. Visa, MasterCard or American Express accepted. For established customers, terms are net 30 days.

Most in-stock items will ship the same day, if ordered by 3 p.m. Eastern time, Monday – Friday. Minimum order is one case of supplies unless otherwise noted. Typographic, descriptive, or photographic errors are subject to correction.

Not Sure Where to Begin?

We can help! Just call us...our Systems and Sales Consultants are experienced and well trained in all aspects of bar coding and RFID. We are committed to providing you with assistance every step of the way.



Monarch®

9825™ & 9855®

Applications for the 9825 and 9855

- Shipping/pallet labeling
- Price and item marking
- Pick and pack
- Compliance labeling
- Inventory control
- Bin marking



9825 Printer Key Features

- Prints thermal direct and thermal transfer labels and perforated tags up to 10 mils thick
- 203 DPI, user-replaceable printhead flips up for easy ribbon and supply loading
- Larger supply rolls result in fewer supply changes
- Unique ribbon control virtually eliminates wrinkling of ribbon
- Dynamic dot shifting for prolonged printhead life
- Print speed up to 6 inches per second (IPS)
- DC-powered cart version available (see p. 23)
- Parallel, Serial and USB connectivity standard
- Optional peel mode and linerless capability

starts at **\$1,675**



9855®: All features of 9825, Plus:

- Super-fast 150 MHz processor and print speeds up to 12 IPS
- Optional knife and stacker for medium volume tag printing
- 203 DPI standard, 300 DPI optional
- Optional full-metal cover
- Memory expansion available

starts at **\$2,200**



Options for the 9855 Printer

- 926™ Knife \$1,205
- 927™ Hopper \$99
- 928™ Tag Stacker \$2,415
- 935™ External Rewind (also 9825 compatible) \$585
- 938™ High Speed Verifier \$2,695
- 939™ Data Entry Keyboard \$399
- 945™ Unwind \$470
- Dual Wired/Wireless Ethernet Controller (also 9825 compatible) \$595
- Internal Ethernet Controller (also 9825 compatible) \$295
- MonarchNet2™ Enterprise Print Management System \$195



4" x 6"



4" x 6"



Monarch® 9860™

Tabletop Bar Code Ticketing System

Applications for the 9860 Printer

- High-volume ticketing
- Item tag printing
- Compliance item tags
- Cutting, stacking tags with batch separators



The 9860 Printer is pictured here with the optional 932 Stacker and 938 Verifier.

9860 Key Features

- Prints clear, crisp thermal direct or thermal transfer hang tags up to 12 mils thick
- Integrated, heavy-duty knife cuts up to 8 IPS
- Sub-second imaging time
- Heavy-duty, full-metal cover
- Verifier option for peace of mind when printing bar codes
- User-friendly keyboard
- 203 DPI, user-replaceable printhead with optional 300 DPI printhead available
- Parallel, Serial and USB connectivity standard
- Optional wired/wireless Ethernet
- 939i keyboard available—provides second serial port for scanner or other external device

starts at **\$5,245**

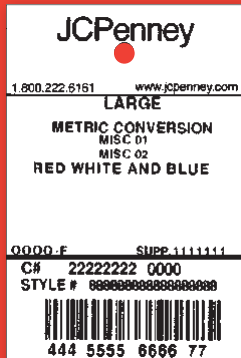

1.5" x 2.2"



1.2" x 2.7"



938™ Verifier \$2,695
(shown with 9860 printer)



932™ Stacker \$2,495



Shown with optional
Monarch® 926™ Knife

Monarch® 9855® RFMP

- Supports UHF protocols, including EPC Gen2 and EM 4122
- Compatible with a full range of inlays including Avery Dennison, Alien Technology, KSW, UPM Raflatac, RFIDentics and more
- Meets OSHA requirements for use in workplace and is FCC certified, RoHS Compliant
- Prints Bar Code Data
- Thermal Direct or Transfer
- Dual Wireless 802.11b/g/Wired Ethernet available

Perfect for:

- Retail Compliance
- DOD Compliance
- Item Level Carton and Pallet Marking
- Asset Tracking
- WIP Tracking

Monarch® 9855® RFMP RFID Printer Encoder

starts at **\$4,995**



Monarch® 9855® HF

- Supports HF protocols, including ISO 15693-2, -3, TI Tag-IT, NXP I-Code and ISO-18000-3
- Meets OSHA requirements for use in workplace and is FCC certified, RoHS Compliant
- Prints Bar Code Data
- Thermal Direct or Transfer
- Dual Wireless 802.11b/g/Wired Ethernet available

Perfect for:

- Item Level Retail
- Pharmaceutical Tracking
- Asset Tracking
- WIP Tracking
- Library Tracking
- Authentication

Monarch® 9855® HF RFID Printer/Encoder

starts at **\$3,995**

Monarch[®] RFID Supplies

- Twice-Tested for Quality
- UHF and HF Protocols
- Pre-Printed Supplies Available
- Smart Label Performance Guarantee on every shipment
- Full line of adhesives, including permanent general purpose, freezer and removable

Perfect for:

- Retail Compliance
- Carton and Pallet Labeling
- Item Level Labeling
- Retail Tags
- Asset Tracking
- High Temperatures
- Cold Temperatures
- Tote Tracking
- Pharmaceutical
- Jewelry Labeling

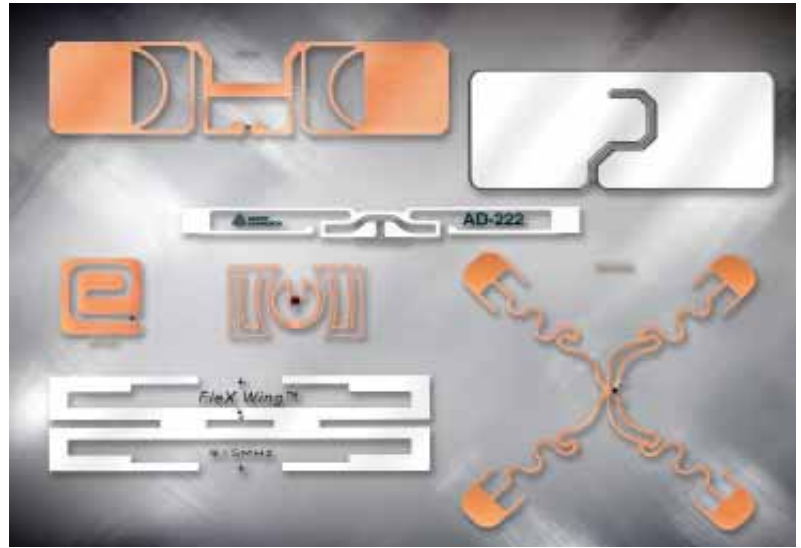

UHF and HF Supplies

We manufacture a wide variety of top quality, reliable RFID supplies for all major RFID printers on the market.

UHF 860-960 MHz protocols

- EPC Gen 2
- EM 4122

HF 13.56 MHz protocols

- ISO 15693-2, -3
- ISO 18000-3
- TI Tag-It
- NXP I-Code
- TASGSYS C270, C370

We work with the best inlay companies in the industry to provide you the solution that works best for your application

- Avery Dennison
- Alien Technology
- KSW Microtec
- RFIDentics
- TAGSYS

RFID Labels

Dimensions	Item No.	M/Case	Antenna
4" x 2"	900651	5.5	Gen 2 AD 222
4" x 6"	900650	3.85	Gen 2 AD 222

Call for availability.
Many more sizes and types available.

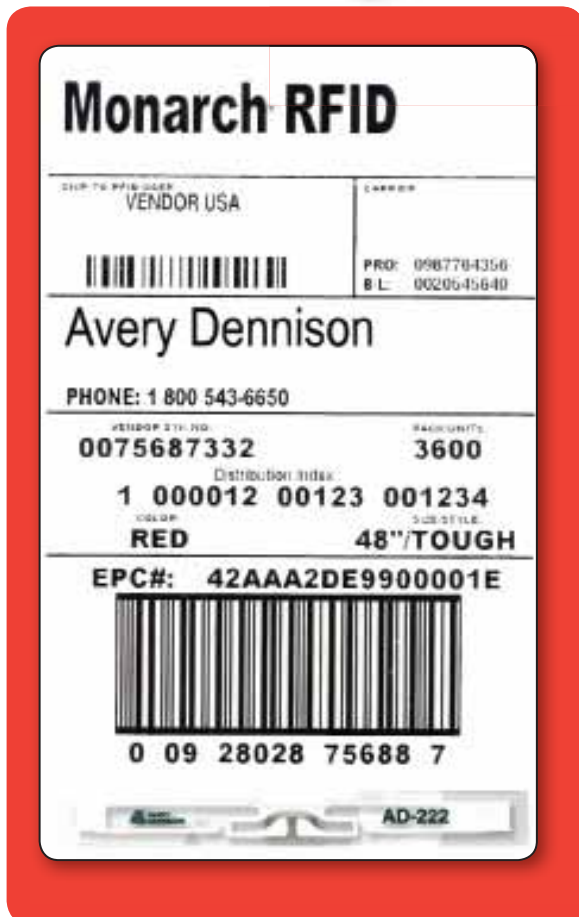

LEGEND:

- 1-900413
- 2-2.0" X 1.0"
- 3-21,000/case

1 ITEM #

2 LABEL SIZE (Width x Length)

3 QUANTITY (per case)

Labels shown are actual size, plain white and are thermal transfer, permanent adhesive unless noted otherwise.

Labels are on rolls and perforated between labels unless noted.

Thermal transfer labels include appropriate number of ribbons.

900322
2.0" X 1.0"
20,740/case
(ultra tuff with clear overlay)

900308
2.1" X 1.8"
24,384/case
(no perforation between Labels)

900423
1.2" X 1.1"
57,800/case
(three across)

900405
1.2" X 0.7"
80,100/case

900413
2.0" X 1.0"
21,000/case

900329
1.5" X 1.1"
57,600/case

900323
1.5" X 1.1"
38,430/case
(two across)

900401
3.0" X 5.0"
4,500/case
(no perforation)

900403
3.0" X 1.5"
14,400/case
(no perforation)

900420
3.0" X 3.0"
7,500/case
(no perforation)

900406
3.0" X 1.0"
20,700/case

900328
2.0" X 1.5"
28,800/case

900313
4.0" X 2.0"
11,100/case

900409
11,100/case
(fanfold, 925 sheets per stack, 2 stacks per case)

900610
2.0" X 1.6"
22,495/case
(ultra removable adhesive)

900412
4.0" X 1.0"
20,700/case

Custom labels also available. Please call for details.

Monarch[®] 9800™ Label and Tag Supplies *cont'd*

900421
4.0" X 8.0"
2,700/case
(no perforation)

900319
4.0" X 6.0"
3,600/case

900318 (cannot be used in the M09820)
3,600/case
(no perforation)

900320
3,800/case
(fanfold, 950 sheets per stack, 2 stacks per case)

No-Mar3 Labels

900576
3,800/case
(fanfold, 950 sheets per stack, 2 stacks per case)

No-Mar3 Labels

900603
3,855/case
(no perforation)

No-Mar3 Labels

900613
3,855/case

No-Mar Advanced

900643
2,983/case

No-Mar Advanced

900643 (fanfold,)
2,983/case

Linerless Thermal Direct

900157
6,000/case

900314
4.0" X 4.0"
5,700/case

900410
5,700/case
(fanfold, 950 sheets per stack, 3 stacks per case)

No-Mar3™ Labels
900617
5,700/case

900324
4.0" X 3.0"
7,400/case
(fanfold, 925 sheets per stack, 2 stacks per case)

Custom labels also available. Please call for details.

9800™ Label and Tag Supplies

In-stock Monarch® Labels and Tags for 9800® Printers

LEGEND:

- 1- 900411
- 2- 1.2" X 1.1"
- 3- 63,900/case

1 ITEM

2 LABEL SIZE (Width x Length)

3 QUANTITY (per case)

Supplies shown are actual size, plain white and are thermal transfer, permanent adhesive unless noted otherwise.

Labels and tags are on rolls.

Thermal transfer supplies include appropriate number of ribbons.

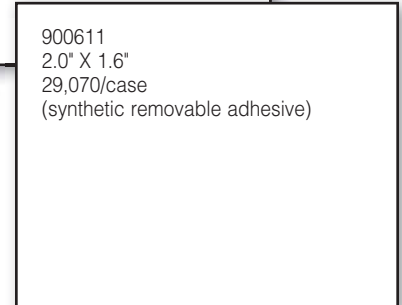
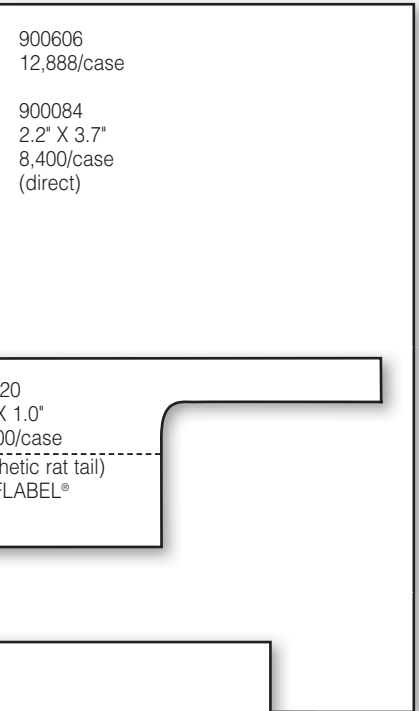
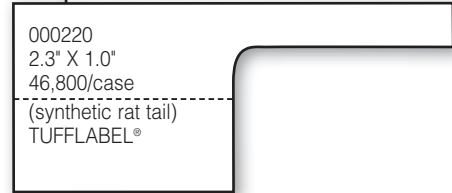
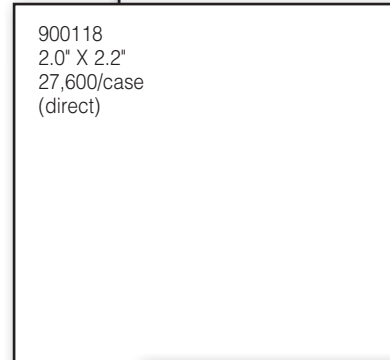
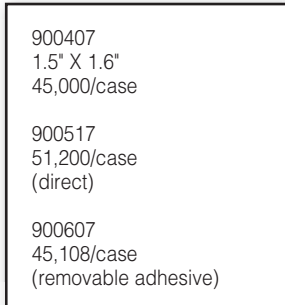
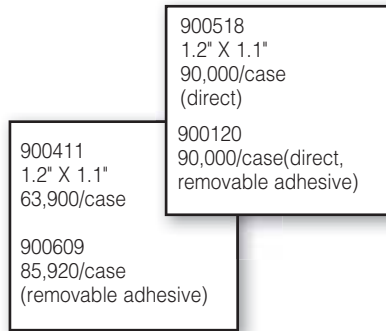
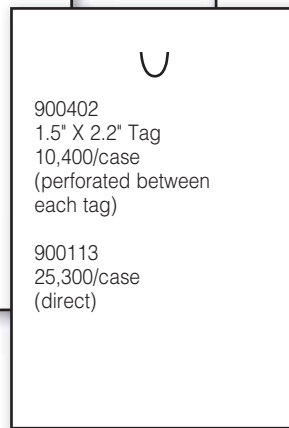
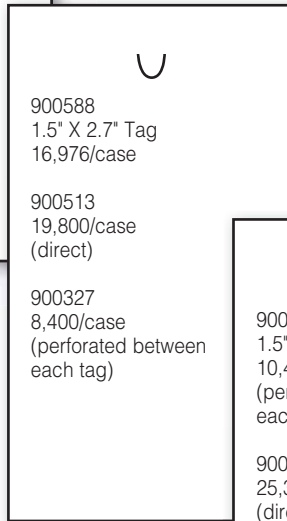
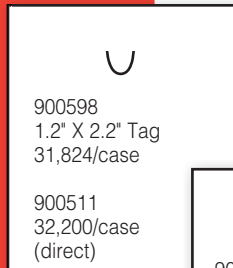
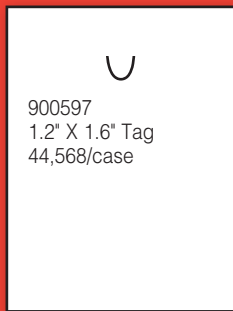

Custom labels also available. Please call for details.

Monarch®

9800™ Label and Tag Supplies *cont'd*

900408
4.0" X 7874" (656")
3 rolls/case
(24,622 inches continuous label)

900587
2.0" X 2.7" Tag
8,640/case

900578 900101
2.4" X 1.2" Tag 28,000/case
19,100/case (direct)

D

900400 900072
3.0" X 1.2" Tag 24,600/case
19,200/case (direct)

900674
3.2" X 1.6" Tag
13,200/case
(direct)

Custom labels also available. Please call for details.

Monarch® Tag Attachers

When it comes to choosing the Attacher and Tagger Tail® Fasteners that are right for you—we are here to help!

Consider when making your selection

What is your Application?

- Price, Brand or Identify Ticketing
- Pairing of Merchandise
- Hanging Merchandise for Display



Fine SG® Attacher

What types of merchandise will you price, pair or display?

- Standard/General Merchandise
- Fine or Delicate Fabrics
- Heavy-Duty Materials
- Specialty Applications

SG® Attacher Needles



954785



954786

Avery Dennison Mark III™ Attacher Needles



954886



954887



954889

Tag Attachers and matching Tagger Tail® Fasteners

Regular SG® Attacher

- Use to attach tags to knit, cotton, lightweight, fine woven fabric
- Soft, non-slip cushion comfort grip molded into handle and trigger
- Provides a firmer grip
- Utilize the 100 clip or 50 clip fasteners
- Compatible with most other manufacturers' fasteners and needles



Regular Attacher MOSGR-01 \$38.50

- 954785 Plastic Shank Needles—4/pack \$21.20
- 118202 All Steel Needles—4/pack \$21.20
- 117802 Heavy Duty All Steel Needles—4/pack \$19.00

Fine SG® Attacher

- Tag delicate and woven fabric such as silk, linen
- Soft, non-slip cushion comfort grip molded into handle and trigger
- Provides a firmer grip
- Utilize the 100 clip or 50 clip fasteners

Fine Attacher MOSGF-01 \$38.50

- 954786 Plastic Shank Needles—4/pack \$25.35
- 118201 All Steel Needles—4/pack \$25.35

Avery Dennison Mark III™ Pistol Tool Attacher

- Ideal for tagging knit shirts, light to medium weight fabrics, cotton, cotton twill corduroy
- Improved ergonomic design—easy squeeze mechanism for operator comfort
- Utilize 50 clip fasteners
- 90 day Written Warranty on attacher



Regular Attacher 954885 \$28.75

- 954886 Short plastic base Needles—4/pack \$13.25
- 954887 Heavy Duty short all steel Needles—4/pack \$25.35

Avery Dennison Mark III™ Fine Fabric™ Pistol Tool Attacher

- Ideal for tagging silk, satin, nylon, elastic, micro fibers, lycra, rayon, polyester, fine linens, infant wear
- Optimized spring tension and short trigger stroke provide smooth operation
- Utilize 50 clip fine fabric fasteners



Fine Attacher 954888 \$29.95

- 954889 Plastic base Needles—4/pack \$13.25
- 954890 (Short all steel) Needles—4/pack \$25.35

Monarch® Fasteners

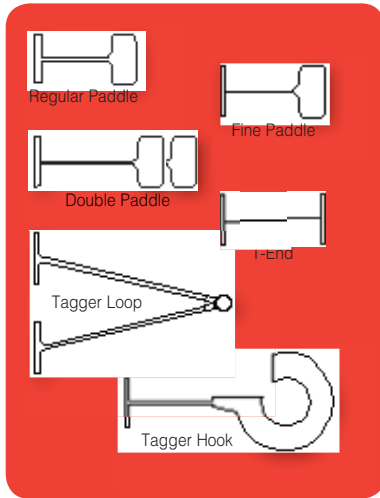

Specialty Attachers

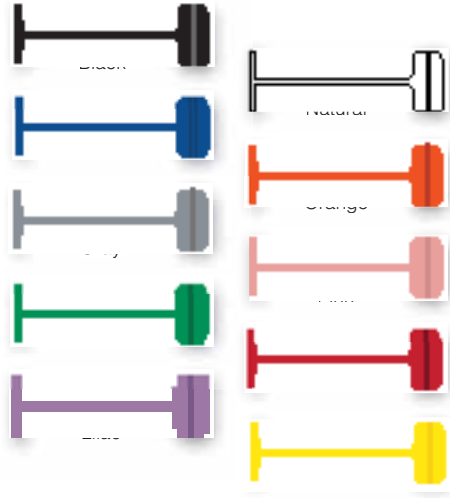

Regular Paddle Fasteners-

Order in multiples of 5,000 unless noted

Size	Per Clip	Color	Tensile Strength***	Order +
1/2"	50	Natural	3.1 lbs.	000902
1/2"	50	Clear Nylon	5.1 lbs.	954605
1/2**	100**	Natural	3.1 lbs.	954777
1/2"	50	Red	3.1 lbs.	954713
1/2"	50	Black	3.1 lbs.	954718
1/2"	50	Green	3.1 lbs.	954717
1/2"	50	Blue	3.1 lbs.	954714
1/2"	50	Yellow	3.1 lbs.	954715
1"	50	Natural	3.1 lbs.	000997
1"	50	Clear Nylon	5.1 lbs.	954604
1**	100**	Natural	3.1 lbs.	954778
1"	50	Red	3.1 lbs.	000111
1"	50	Black	3.1 lbs.	000112
1"	50	Green	3.1 lbs.	000113
1"	50	Blue	3.1 lbs.	000114
1"	50	Yellow	3.1 lbs.	000115
1"	50	Pink	3.1 lbs.	900260
1"	50	Orange	3.1 lbs.	900261
1"	50	Gray	3.1 lbs.	954462
1"	50	Lilac	3.1 lbs.	954498
2"	50	Natural	3.1 lbs.	900212
3"	50	Natural	3.1 lbs.	000994
3**	100**	Natural	3.1 lbs.	954780
3"	50	Red	3.1 lbs.	000123
3"	50	Black	3.1 lbs.	000124
3"	50	Green	3.1 lbs.	000125
3"	50	Blue	3.1 lbs.	000126
3"	50	Yellow	3.1 lbs.	000127
3"	50	Pink	3.1 lbs.	900257
3"	50	Orange	3.1 lbs.	900256
5"	50	Clear Nylon	5.1 lbs.	000993

*Order in multiples of 10,000 **SG Attacher **MOSGR-01** is the only attacher that can utilize the 100 clip fasteners

***Minimum Tensile Strength

Fine Paddle Fasteners-

Order in multiples of 5,000 unless noted

Size	Per Clip	Color	Tensile Strength***	Order
1/2"	50	Natural	2.3 lbs.	000916
3/8**	50	T-End Natural	3.5 lbs.	954343
3/4"	50	Clear Nylon	2.3 lbs.	000968
3/4"	50	White	2.3 lbs.	954174
3/4**	100**	Natural	2.3 lbs.	954781
3/4**	100**	Clear Nylon	2.3 lbs.	954784
1"	50	Natural	2.3 lbs.	000991
1**	100**	Natural	3.5 lbs.	954782
2"	50	Natural	2.3 lbs.	000985
2**	100**	Natural	2.3 lbs.	954783
3"	50	Natural	2.3 lbs.	954432

*Order in multiples of 10,000 **SG Attacher **MOSGF-01** is the only attacher that can utilize the 100 clip fasteners

***Minimum Tensile Strength

Regular Hook Fasteners-

Order in multiples of 5,000

Size	Per Clip	Color	Tensile Strength***	Order
1-1/2"	50	Natural	3.1 lbs.	000918
2"	50	Natural	3.1 lbs.	000919

***Minimum Tensile Strength

Regular Loop Fasteners-

Order in multiples of 5,000

Size	Per Clip	Color	Tensile Strength***	Order
1-1/2"	25	Clear Nylon	5.1 lbs.	900341
3"	25	Clear Nylon	5.1 lbs.	900342

***Minimum Tensile Strength



String Tach™

If you want to reflect an up scale image—use String Tachs! Use to secure price or brand identity tags onto product. Polyester thread with durable plastic ends lock easily into place. Available in Black or White strings. 100 per pack.

Shipped immediately.

954909 4.7" Black Poly Thread
954905 7.9" White Poly Thread



Display-It Hooks— Increase Product Visibility

- Provide a durable method for hanging items
- Hang socks, gloves, toys and more
- Use in conjunction with Attacher & Tagger Tail® Fasteners
- Will not crack or fall off under constant handling
- 1-7/8" available in Black or White

Shipped immediately.

954223 White
954222 Black

Minimum order 2,000.

Monarch®

Monarch® 9854™ Printer

- 150 MHz processor and print speeds up to 8 IPS
- Fast, easy and intuitive supply loading
- Real time clock built in to allow for date/time stamp
- Secure off-line operation—store formats on removable compact flash card
- 4.72" supply widths, max. print length is 39.4"
- Wired Ethernet, one USB port, serial port, parallel port and PS 2 keyboard port
- Free starter edition of NiceLabel Software is shipped with each printer
- Accessories include
 - Foot switch for controlling on-demand mode
 - Mini keyboard for off-line data entry
 - Compact flash expanded memory card for formats, fonts and/or graphics
 - Cutters available

starts at **\$2,395**



4" x 6"



9854 Ribbons High Speed Wax

Item No.	Width		Length Feet
	Inches	mm	
12747315	1.52	38	1640
12747320	2.0	53	1640
12747330	3.125	79	1640
12747335	3.5	89	1640
12747340	4.25	108	1640
12747345	4.5	114	1640

See page 21 for additional 9854 ribbons

9854 Labels

Item No.	Width	Length	M Labels/
	Inches	Inches	
900655	1.2	0.75	58.626
900656	1.5	1	30.396
900657	2	1.125	40.528
900658	2	1.5	28.056
900659	4	2	8.046
900660	4	4	4.143
900661	4	6	2.79

All other labels for this printer must be custom quoted. Please call for details.

Monarch®

Monarch® 9864™ Printer

- 4", 5", 6" or 8" printer
- 400 MHz processor and print speeds up to 16 IPS
- Industrial design stands up to harsh conditions with a protective equipment rating of IP41
- Built-in ribbon saver
- Real time clock built-in to allow for date/time stamp
- Secure off-line operation—store formats on removable compact flash card
- 1.2"-8.5" supply widths, max. print length is 39.4"
- Wired Ethernet, two USB ports, serial port, parallel port and PS 2 keyboard port
- Free starter edition of NiceLabel Software is shipped with each printer
- Accessories include
 - Foot switch for controlling on-demand mode
 - Mini keyboard for off-line data entry
 - Remote display
 - Compact flash expanded memory card for formats, fonts and/or graphics
 - Dispenser module (not on 8")
 - Cutters available

starts at **\$6,116**

9864 Ribbons Near Edge Wax/Resin

Item No.	Width		Length Feet
	Inches	mm	
900539	2.09"	53	1968'
900538	2.52"	64	1968'
900532	3.50"	89	1968'
900535	4.33"	110	1968'
900652	5.12"	130	1968'
900653	5.98"	153	1968'
900654	8.43"	214	1968'



Thermal Transfer Labels

Dimensions	Item No.	M Per Case
4.5" x 2.5"	909854	10.0M
4.5" x 3"	909855	7.6M
4.5" x 4.5"	909856	5.6M
4.5" x 5"	909857	4.8M
4.5" x 6"	909858	3.98M
5" x 2.5"	909859	10.0M
5" x 3"	909860	7.6M
6" x 4" Fanfold	910082	3.0M
5" x 4"	909861	6.0M
6" x 4"	909862	6.0M
6.5" x 4"	909863	6.0M
8.5" x 6"	909864	4.0M

Thermal Direct Labels

Dimensions	Item No.	M Per Case
4.5" x 2.5"	909937	10.0M
4.5" x 4.5"	909938	5.6M
4.5" x 6"	909939	4.0M
6" x 4"	909940	6.0M

Other labels shown on pages 18-20.

Monarch®

Pathfinder® Ultra® Silver 6032™ Printer

Applications for the Pathfinder
Ultra® Silver 6032™ printer

- Markdowns
- In-store pricing
- Item UPC marking
- Item identification
- Routing



Key Features and Benefits of the Pathfinder Ultra Silver 6032™

- Complete, stand-alone label printing system
- Combines a scanner (optional) and label printer in a unique “print and apply” design
- User-friendly design keeps one hand free to handle merchandise
- Eliminates walk time to a stationary printer
- Lithium Ion battery for longer use between charges
- Work faster and increase productivity
- 203 DPI, 2-inch-wide printhead
- 10 standard formats included (see below)
- Custom format development available
- Lookup capability available

starts at **\$1,255**



Standard Ultra® Silver
label formats
Custom formats
available



1.5" x 1.1"



Monarch® Products and Services

Monarch® Pathfinder® Ultra® Platinum 6039™ Printer

Applications for the Pathfinder® Ultra® Platinum 6039™ printer

- Markdowns/Markups
- Receiving
- Store Transfers
- Replacement Tags
- Item Marking
- Remarketing



Pathfinder® Ultra® Silver and Platinum Supplies

Dimensions	Item No.	M Per Case
1.5" x 1.1" Piggy back	900692	16.0
1.2" x .8"	900355	37.5
1.2" x 1.1"	900441	25.75
1.5" x 1.1"	900690	20.0
1.5" x 1.5"	900392	16.0
1.5" x 2.2"	900346	10.8
1.5" x 2.5"	900573	9.28
2" x 2"	900391	9.0
2" x 4"	900695	4.5
2" x 3" Receipt Paper	000022	15.6

**All stock labels have permanent adhesive.
Custom labels also available. Please call for details.**

Deluxe Handheld Data Terminal Printer and Scanner

Key Features and Benefits of the Pathfinder Ultra Platinum 6039™

- A lightweight, one-piece handheld thermal printer, laser scanner and data terminal helps reduce labor hours
- Windows CE operating system for greater programming flexibility
- Touchscreen technology for quick and efficient operation
- Prints receipts, tags and labels promoting versatility in your marking processes
- 64MB of flash memory and up to 512MB SD increases application, language and video capacity/memory
- Integrated RF (radio frequency) connectivity available
- Lithium Ion battery for longer use between charges
- Custom programming available

starts at **\$3,000**



Monarch®

9416®XL®

Applications for the Monarch 9416XL® Desktop Printer:

- Prints tags, labels and receipts
- Item/price marking
- Shelf labeling
- Re-ticketing



Monarch® 9416®XL®
Thermal Direct Desktop Printer



Monarch® 9416®TTXL™
Thermal Transfer Desktop Printer

Desktop Printer

Key Features and Benefits

- Selectable print speed, up to 5 IPS
- Thermal Transfer or Thermal Direct available
- Easy-to-load clamshell design
- Printing versatility
- 8MB of RAM, 2MB of Flash
- Memory upgrades with SD card
- Parallel, Serial and USB connectivity
- Prints labels up to 2.4 mils thick and tags up to 10 mils thick
- PC Software included to create and print format



Thermal Direct

starts at **\$570**

Thermal Transfer

starts at **\$650**

9416® Desktop Printer Labels

Label Sizes Available—Both Transfer and Direct

Dimensions	Thermal Transfer	Thermal Direct	M Per Case
1.5" x 1.1"	900628	—	17.262
2.0" x 1.0"	909964	909959	16.5"
2.25" x 1.25"	909946	909947	13.62
3" x 1"	909965	909960	16.5
3.5" x 1.0"	909966	909961	16.5
4" x 1.0"	909967	909962	16.5
4" x 1.5"	909948	909949	11.52
4" x 2.0"	909968	909963	8.82
4" x 3"	909950	909951	6.0
4" x 4"	909972	909958	4.56
4" x 6"	909952	909953	3.0
4" x 6.5"	909954	909955	2.76
4" x 6.75"	—	909969	3.0

9416® Desktop Printer Tags

Fanfold, Transfer, Perforation between each tag

Dimensions	Item No.	M Per Case
3" x 1.5"	909942	8.0
4" x 3"	909943	4.0
4" x 6"	909944	4.0
4" x 6.5"	909945	4.0

*Includes chadless for attacher

Monarch® supplies will work in Monarch 9416 printer as well as some Zebra Eltron Desktop printers.



Monarch® Products and Services

Monarch®

Sierra Sport™2 9460™ Portable Printer

9433™ SS3



Portable Bar Code Printers

Monarch Sierra Sport2 Printer Key Features and Benefits

- Versatile: set on tabletops, carry by hand, waist or shoulder straps
- Power options include rechargeable Lithium Ion battery or AC adapter
- Eliminate cables with wireless options such as Bluetooth
- Fast, clean imaging up to 3 IPS at 203 DPI
- Handles thermal direct labels, tags or receipts up to 2-inch print width
- Multiple connectivity options including 802.11 b/g wireless in the 9460SNP
- Supply roll on door for easy loading

starts at **\$891**

Sierra Sport Printer Supplies

Dimensions	Description	M Per Case
1.2" x 1.1"	Permanent Adhesive	16.32
1.9" x 1.1"	General Purpose/Freezer Grade Adhesive	12
2.9" x 1.1"	Removable Adhesive	8

*SS3 (9433) only



Features and Benefits of Monarch® 9433 Sierra Sport3 Printer

- Paper, synthetic, tag or linerless roll or fanfold from .75" to 3" wide
- RS-232, USB, Optional Bluetooth
- Operates on any 802.11b/g WiFi RF Network
- Supports MPCLII
- Prints up to 3.6 IPS
- Shoulder strap for hands free operation
- Lightweight and durable
- Fanfold slot for continuous supplies or card stock
- Supply roll on door for easy loading

starts at **\$995**

Custom labels also available. Please call for details.

Thermal Transfer Labels

Dimensions	Item No.	M Per Case
1" x 1"	909800	44.0M
1" x 2"	909801	23.2M
1" x 3"	909802	15.2M
1" x 4"	909803	12.0M
1.3" x .5"	909804	76.8M
1.5" x .8"	909806	60.0M
2 wide 1.5" x .8"	909805	60.0M
1.5" x 1"	909807	44.0M
2 wide 1.5" x 1"	909808	40.0M
1.5" x 1.3"	909809	35.6M
1.5" x 1.5"	909810	28.8M
2 wide 1.5" x 1.5"	909811	28.8M
1.5" x 2"	909812	23.2M
1.8" x 2.5"	909813	20.0M
2" x 1"	909814	44.0M
2 wide 2" x 1"	909815	44.0M
2" x 1.3"	909816	35.6M
2" x 1.5"	909817	28.8M
2" x 2"	909818	23.2M
2" x 3"	909819	15.2M
2" x 4"	909820	12.0M
2.3" x 1.3"	909821	35.6M
2.5" x 1"	909822	44.0M
2.5" x 1.5"	909823	28.8M
2.5" x 2"	909824	23.2M
2.5" x 2.5"	909825	20.0M
2.8" x .7"	909826	42.7M
3" x 1"	909827	44.0M
3" x 1.5"	909828	28.8M
3" x 2"	909829	24.0M
3" x 3"	909830	16.0M
3" x 3.5"	909831	13.6M
3" x 4"	909832	12.0M
3" x 5"	909833	9.6M
3.1" x 5"	909834	4.7M
3.5" x 1"	909835	22.0M

Thermal Transfer Labels (cont'd)

Dimensions	Item No.	M Per Case
3.5" x 1.5"	909836	14.4M
3.5" x 2"	909837	12.0M
3.5" x 8"	909838	3.0M
4" x 1"	909839	22.0M
4" x 1.5"	909840	14.4M
4" x 2"	909841	11.6M
4" x 2**	909842	11.6M
4" x 2.3"	909843	10.3M
4" x 2.5"	909844	10.0M
4" x 3"	909845	7.6M
4" x 3**	909846	7.6M
4" x 4"	909847	6.0M
4" x 5"	909848	4.8M
4" x 6"	909849	4.0M
4" x 6**	909850	4.0M
4" x 6.5"	909851	3.6M
4" x 8"	909852	3.0M
4" x 1.3"	909853	1.8M
4.5" x 2.5"	909854	10.0M
4.5" x 3"	909855	7.6M
4.5" x 4.5"	909856	5.6M
4.5" x 5"	909857	4.8M
4.5" x 6"	909858	3.98M
5" x 2.5"	909859	10.0M
5" x 3"	909860	7.6M
5" x 4"	909861	6.0M
6" x 4"	909862	6.0M
6.5" x 4"	909863	6.0M
8.5" x 6"	909864	4.0M

* No perforation

- Monarch® supplies will work in many thermal printers, such as Zebra, Datamax and Intermec.
- All supplies are wound out and are on 3" core unless noted. Supply roll has 8" outer diameter.
- Ribbons are sold separately and can be found on page 21.

**Custom labels also available.
Please call for details.**

Supplies for Zebra and Other Printers (cont'd)

Thermal Direct Labels

Dimensions	Item No.	M Per Case
1" x 1"	910110	44.0M
1" x 4"	909912	12.0M
1.5" x 1"	909913	44.0M
1.5" x 1.3"	909914	35.6M
1.5" x 1.5"	909915	28.8M
2" x 1"	909916	44.0M
2" x 2"	909917	23.2M
2" x 3"	909918	15.2M
2.3" x 1.3"	909919	35.6M
2.5" x 1"	909920	44.0M
2.5" x 2"	909921	23.2M
3" x 1"	909922	44.0M
3" x 2"	909923	23.2M
3" x 3"	909924	15.2M
3" x 5"	909925	9.6M
3.1" x 5"	909926	4.8M
3.5" x 1"	909927	22.0M
3.5" x 1.5"	909928	14.4M
4" x 1"	909929	22.0M
4" x 1.5"	909930	14.4M
4" x 2"	909931	11.6M
4" x 3"	909933	7.6M
4" x 4"	909934	6.0M
4" x 6"	900422	4.0M
4" x 6.5"	909936	3.6M
4.5" x 2.5"	909937	10.0M
4.5" x 4.5"	909938	5.6M
4.5" x 6"	909939	4.0M
6" x 4"	909940	6.0M

Warehouse Label

4" x 6.5" with 1/2" Horizontal Color Bar at Trailing Edge

Dimensions	Item No.	M Per Case
4" x 6.5" Blue	909868	4.0M
4" x 6.5" Green	909869	4.0M
4" x 6.5" Orange	909870	4.0M
4" x 6.5" Purple	909871	4.0M

* Pink, Tan, or Yellow – Available as Custom

Full Tint Labels

Thermal Transfer

Dimensions	Item No.	M Per Case
4" x 2" Blue	910009	11.6M
4" x 2" Green	910092	11.6M
4" x 2" Orange	910093	11.6M
4" x 2" Yellow	910075	11.6M
4" x 6" Yellow	909873	4.0M
4" x 6" Pink	909874	4.0M
4" x 6" Green	909875	4.0M
4" x 6" Red	910091	4.0M
4" x 6" Blue	909876	4.0M
4" x 6" Orange	909877	4.0M

Fluorescent 4" x 6" Labels

Thermal Transfer

Dimensions	Item No.	M Per Case
4" x 6" FL Red	909878	4.0M
4" x 6" FL Chartreuse	909879	4.0M
4" x 6" FL Green	909880	4.0M
4" x 6" FL Orange	909881	4.0M
4" x 6" FL Pink	909882	4.0M

1.5" Diameter Circles

Thermal Transfer

Dimensions	Item No.	M Per Case
1.5" x 1.5" FL Red	909883	26.29M
1.5" x 1.5" FL Chartreuse	909884	26.29M
1.5" x 1.5" FL Green	909885	26.29M
1.5" x 1.5" FL Orange	909886	26.29M
1.5" x 1.5" FL Pink	909887	26.29M
1.5" x 1.5" White	909888	28.0M
1.5" x 1.5" Blue	910016	4.0M

Fanfold

Thermal Direct

Dimensions	Item No.	M Per Case
4" x 6"	900647	4.0M

**Custom labels also available.
Please call for details.**

Fanfold
Thermal Transfer

Dimensions	Item No.	M Per Case
4" x 1"	910115	21.0.0M
4" x 2"	909865	5.0M
4" x 3"	909743	5.0M
4" x 4"	909957	5.0M
4" x 6"	909956	4.0M
4" x 6.5"	909867	4.0M
6" x 4"	910082	3.0M

Fanfold Tags

Thermal Transfer C1S Tag Stock—7 Mils,
Notches at Perf. for Sensing

Dimensions	Item No.	M Per Case
3" x 1.5**	909942	8.0M
4" x 3"	909943	4.0M
4" x 6"	909944	4.0M
4" x 6.5"	909945	4.0M

* With chadless for attacher

Removable Adhesive
Thermal Transfer

Dimensions	Item No.	M Per Case
3" x 1"	910085	44.0M
4" x 6"	909889	4.0M

TUFFLABEL®
Smudge Proof Kimdura

Dimensions	Item No.	M Per Case
2" x 1"	909897	41.2M
4" x 2"	909898	10.92M
4" x 6"	909899	3.8M

Shipping Label with Doc. Tab
8" O.D. Thermal Direct (Near IR) No Perf.

Dimensions	Item No.	M Per Case
4" x 6.8"	909971	3.28M

TUFFMARK® II White Gloss Polyester
U.L. Recognized Component

Dimensions	Item No.	M Per Case
1.5" x .8"	909904	60.0M
2 wide 1.5" x .8"	909905	60.0M
1.8" x .5"	909906	80.0M
2" x 1"	909907	40.0M
3" x 1"	909908	40.0M
4" x 1"	909909	20.0M
4" x 2"	909910	12.0M
4" x 6"	909911	4.2M

No-Mar™ Labels

Dimensions	Item No.	M Per Case
4" x 6"	900625	3.237M
4" x 6**	900616	3.237M
4" x 6***	900629	3.9M

* No Perf
** Fanfold

- Monarch® supplies will work in many thermal printers, such as Zebra, Datamax and Intermec.
- All supplies are wound out and are on 3" core unless noted. Supply roll has 8" outer diameter.
- Ribbons are sold separately and can be found on page 21.

Custom labels also available. Please call for details.

Monarch® Ribbons for Zebra and Other Printers

Ribbons

Monarch ribbons are available for virtually all thermal printers on the market today.

Our technical experts can help you select the most appropriate ribbon for your printing needs.



Resin Ribbon

Best suited for: Harsh outdoor applications or other applications requiring superior durability, chemical exposure or highly abrasive conditions. Primarily used on highly durable coated polyester or polyamide films.

Resin

For use with some models of printer brands shown below

Supply Width	Zebra	Intermec	Datamax	Sato 8400	Monarch 9854
Up to 2 inches	909659	Custom Quoted	909265	909265	909265
Up to 4 inches	909660	909635	909266	909727	909266

Standard Wax Ribbon

Best suited for: Short-lived applications with only light label/tag contact during handling; long-term durability not required. Primarily used on coated and uncoated label and tag stocks and coated polyethylene and polypropylene synthetic film.

Wax

For use with some models of printer brands shown below

Supply Width	Zebra	Intermec	Datamax	Sato 8400	Monarch
Up to 2 inches	910040	909273	910026	910026	910026
Up to 3 inches	910045	909256	910028	910028	910028
Up to 4 inches	910052	910090	910031	910031	910031

No-Mar™ Ribbons

For use with item 900616 No-Mar labels in some models of printer brands shown below

Supply Width	Zebra	Intermec	Datamax	Sato 8400
Up to 4 inches	910052	910011	910031	910109

Wax/Resin Ribbon

Best suited for: Outdoor and other demanding applications requiring more durable images, incidental chemical exposure, multiple scans or other rough handling situations. Recommended for use with coated labels and tags, coated and uncoated polyethylene and polypropylene films, and coated Tyvek.

Wax/Resin

For use with some models of printer brands shown below

Supply Width	Zebra	Intermec	Datamax	Sato 8400	Monarch 9854
Up to 2 inches	Custom Quoted	Custom Quoted	909262	909262	909262
Up to 3 inches	909715	Custom Quoted	909266	Custom Quoted	Custom Quoted
Up to 4 inches	909353	Custom Quoted	126301	126301	126301

Monarch® Economy Kits



Monarch® 9416®
Thermal Direct Printer



Off-line Printer Solutions

Economy Kits

Monarch 9416CT-

\$1,150 + Format & Download Charge

- Monarch 9416 thermal transfer printer
- KU008 Keyboard
- External supply holder

Option:

- Up to 8 additional formats at \$250 each

Monarch 9416FFKIT-\$1,310

- Monarch 9416 thermal transfer printer
- Monarch 939i Intelligent Qwerty Keyboard
- 11 fixed formats

Option:

- External supply holder \$75
- Keyboard stand \$104

Monarch 9416CTi-

\$1,465 + Format & Download Charge

- Monarch 9416 thermal transfer printer
- Monarch 939i Intelligent Qwerty Keyboard

Option:

- External custom formats (quoted)
- External Supply Holder \$75
- Keyboard Stand \$104
- Scanner \$210



Monarch® 939i Intelligent
Qwerty Keyboard

Value Kits

Monarch 9825-

\$2,200 + Format & Download Charge

- Monarch 9825 thermal bar code printer
- Monarch 939i Intelligent Qwerty Keyboard

Option:

- Unlimited custom formats at \$250 each
- Scanner input or custom applications available in a quoted script
- Keyboard Stand \$104
- Scanner \$210
- Monarch® 935 Rewind \$585

Industrial Kits

Monarch 9855CT-\$2,515

- Monarch 9855 thermal bar code printer
- Monarch 939 terminal

Option:

- Unlimited custom formats at \$250 each
- Monarch® 935 Rewind \$585

Monarch 9855CTi-\$2,725

- Monarch 9855 thermal bar code printer
- Monarch 939i intelligent Qwerty Keyboard

Option:

- Unlimited custom formats at \$250 each
- Scanner input or custom applications available in a quoted script
- Keyboard Stand \$104
- Scanner \$210
- Monarch® 935 Rewind \$585

Monarch[®]

MWS[™]



Monarch 9878-C1[™]



Monarch 9878-C[™]MWS



Monarch 9876[™]MWS

Mobile Work Stations

Retail MWS Solutions—Choose the system size to fit your needs!

Monarch 9878-C1[™] Mobile Pricing MWS—

Same benefits and performance as our full-sized workstations with a smaller footprint for greater maneuverability!

- Long lasting—run a desktop printer, laptop and data terminal for 20-100 hours (based on equipment) before requiring a charge
 - Streamline pricing process—take printer to the product, even in narrow aisles
- starts at **\$1,795**

Monarch 9878C3[™] MWS—small investment, big return

- Long lasting—run a tabletop printer, laptop and data terminal for 20-100 hours (based on equipment) before requiring a charge
 - Small enough to fit into tight work areas, but big enough to complete the job
- starts at **\$2,095**

Monarch 9878-03[™] Mobile Pricing MWS—

Print shelf labels, markdown labels, small signs in the aisle at the product location

- Long lasting—run a tabletop printer, laptop and data terminal for 20-100 hours (based on equipment) before requiring a charge
 - Simplifies process—holds all tools and provides work space for associates
- starts at **\$2,395**

Monarch 9878-LSP[™] Mobile Printing MWS—

Prints signs one at a time, right on the selling floor!

- Long lasting—enough power to run a medium-sized laser printer for 6-10 hours before requiring a charge.
 - Improves accuracy—the right sign is automatically verified and printed at the product
- starts at **\$2,995**



Monarch 9878-03[™]



Monarch 9878-LSP[™]

DC MWS Solutions—Choose the system size to fit your needs!

Monarch 9876[™] MWS Series—Helps you work through inventory changes without moving the items!

- Long lasting—run a tabletop printer, laptop and data terminal for 20-100 hours (based on equipment) before requiring a charge
 - Simplifies process—space and power to be a total mobile employee workstation
- starts at **\$2,195**

Monarch 9878[™] MWS Series—Print labels on the spot

- Long lasting—run a tabletop printer, laptop and data terminal for 20-100 hours (based on equipment) before requiring a charge
 - Fits under/over most conveyors
- starts at **\$1,795**



Monarch 9878[™]MWS

To order, call **1-800-543-6650, press 5** (Monday-Friday, 8am-5pm ET) • www.monarch.com

Labels and Tags for Laser/Inkjet Printers

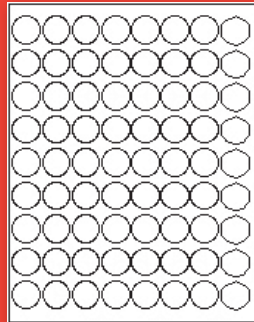

1" Circle

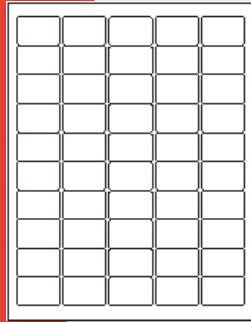

1.5" x 1"

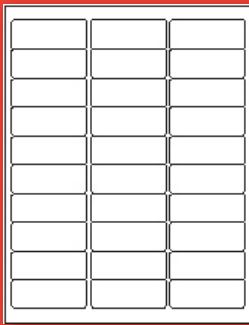

2.6" x 1"

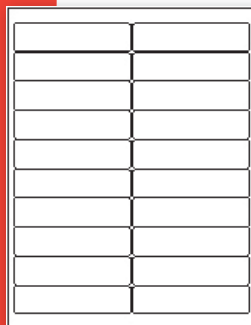

3.4" x .9"

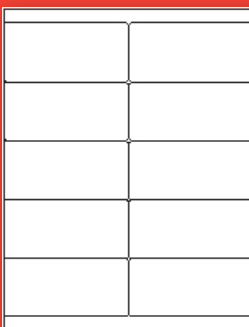

4" x 2"

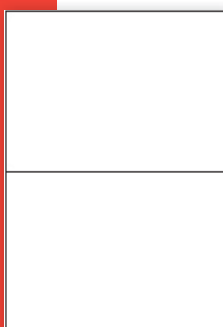

8.5" x 5.5"

Die Cut, Permanent Adhesive

8.5" x 11" Sheet

Dimensions	Item No.	Labels Per Sheet
1" Circle	909775	63
1.5" x .5"	909796	100
1.5" x 1"	909797	50
1.5" Circle	909774	24
1.8" x .5"	909798	80
1.8" x 1"	909795	44
2.5" x 1.6"	909794	18
2.5" Circle	909773	12
2.6" x 1"	909793	30
2.8" x 1"	909792	33
3.5" x .8"	909789	28
4" x 1"	909788	20
4" x 1.8"	909787	12
4" x 2"	909786	10
4" x 3.3"	909785	6
4" x .5"	909784	4
4.3" x 1"	909783	22
4.3" x 1.5"	909782	14
4.3" x 2"	909781	10
4.3" x 2.8"	909780	8
4.25" x 5.5"	909779	4
8.5" x 11"	909776	1
8.5" x 3.5"	909778	3
8.5" x 5.5"	909777	2

All cases contain 1,000 sheets

Custom labels also available. Please call for details.

Labels and Tags for Laser/Inkjet Printers (cont'd)

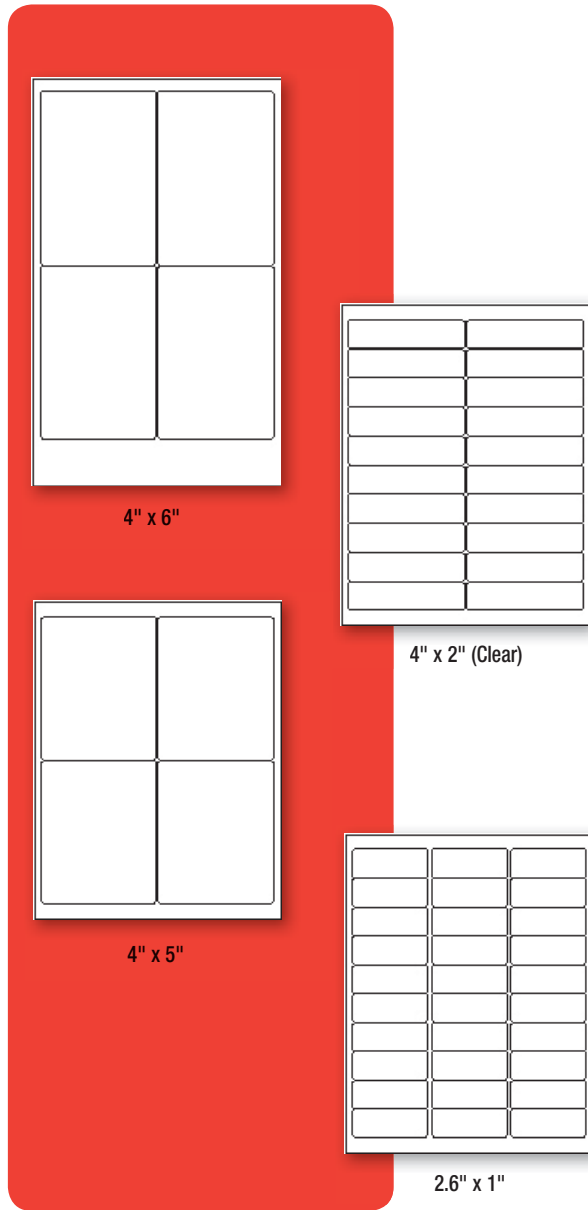

4" x 6"

4" x 2" (Clear)

4" x 5"

2.6" x 1"

Die Cut, Permanent Adhesive

8.5" x 14" Sheet

Dimensions	Item No.	Labels Per Sheet
4" x 6"	909771	4
4.3" x 14"	909772	2
8.5" x 14"	909770	1

Die Cut, Removable Adhesive

8.5" x 11" Sheet

Dimensions	Item No.	Labels Per Sheet
2.6" x 1"	909769	30
4" x 2"	909768	10

Die Cut, Ultra-Removable Adhesive

8.5" x 11" Sheet

Dimensions	Item No.	Labels Per Sheet
4" x 2"	909767	10
4" x 5"	909766	4

Die Cut, Clear Synthetic

8.5" x 11" Sheet

Dimensions	Item No.	Labels Per Sheet
2.6" x 1"	909765	30
4" x 2"	909764	10

Die Cut, 7 Pt Tag,

8.5" x 11" Sheet

Dimensions	Item No.	Labels Per Sheet
3.4" x .9"	909762	20
3.4" x 2"	909763	10

Custom labels also available. Please call for details.

The Tools You Need for Integration and Printer Management

System Integration Solutions

Avery Dennison's System Integration Group provides integration services to allow your Monarch equipment to work with your existing systems. Avery Dennison can also develop custom formats, software and scripts to make our printers best fit your needs.

Network Solutions

Avery Dennison has developed a variety of Monarch integration and printer management tools—all designed to keep you connected.

Many of our printers support a wide range of networking standards, including Ethernet, Bluetooth, IP Addressability, Coax/Twinax and ERP Connectivity.

Our MonarchNet2™ Enterprise Printer Management System allows you to improve the efficiency of your operations by providing complete visibility and control of networked printers from one central location.

Software Solutions

Label Design and Management Software for PC

NiceLabel Express

- Comprehensive label design with wizard driven interface
- Supports industry standard linear and composite bar codes
- Simple data base support

NiceLabel Pro

- Full-featured label design and printing, including RFID capabilities
- Easy to use with wizard-driven label generation tools
- Support for latest 2-D barcode symbologies including PDF-417
- Complete database support (ODBC, SQL, Excell, Access, etc)

Nice Label Suite

- All of the features of NiceLabel Pro, plus powerful tools for printer management and application integration
 - NiceForm—Create user-friendly interfaces for label printing operators
 - NiceWatch—Label printing server for label printing on any platform or operating system
 - NicePrint—Pre-designed production interfaces ensures error free label printing
 - Pocket NiceLabel—Label printing interface for handheld (Windows CE) devices

Loftware Label Manager

- Supports unlimited printers from one workstation
- Provides design and print solution for bar code labels in an environment that does not require integration into larger business systems

BarTender Enterprise Edition Software

- Support unlimited users and up to 3 printers
- Provides a full range of powerful features including label design, data access and the ability to allow automation control by other programs

BarTender Professional Edition Software

- Supports unlimited printers from one workstation
- Provides powerful label design and data access

Label Design and Management Software for IBM iSeries (AS/400) computers

Cybra MarkMagic5

- Design bar code labels on any PC with a connection to an iSeries
- Unparalleled printing performance and complete control over print options including paper handling, cutting, stacking and other finishing requirements

Monarch®

Service and System Integration Services

Services Available

- Preventative maintenance
- Service agreements
- Warranty repair for Monarch and Avery Dennison printers
- Installation
- Dedicated electronic repair center for ship-in service
- Overnight printer replacement
- Service for non-Avery Dennison/Monarch equipment

System Integration Services

- Consulting
- Custom Programming
- Installation/Training
- Project Management
- Systems Design
- Custom Media
- Training
- Maintenance and Repair
- Documentation
- Support



Responsive and Reliable Service

Your equipment needs to operate at peak performance levels at all times to ensure maximum productivity and on-time delivery. You can depend on the expertise and responsiveness of the Monarch Service Group to meet these needs. We can assume responsibility for installation, preventative maintenance and service agreements for your printers as well as providing warranty coverage for Avery Dennison printers.

- Global presence
- Service engineers have an average of 21 years experience
- Toll-free phone support available Monday–Friday, 8 a.m. – 5 p.m. Eastern time



System Integration Service

Why put up with inefficient compliance labeling, re-ticketing, inventory flow and manual data entry when you can increase efficiency with system solutions that quickly pay for themselves? Our System Integration Group specializes in developing innovative solutions that can include any combination of Monarch products and services, in-house application software development, OEM products, third-party integration, and professional services. Let our consultants help you create the best possible solution to your business challenges.

For more information on our service offerings, contact us at 800-543-6650, prompt 5

Monarch[®] Q-Service[®] Pre-printed Labels and Tags from Avery Dennison



Q-Service[®]

- Call 1-800-543-6650 ext. 2096 or e-mail qservice@averydennison.com for Q-Service order form.
- Select any of the 9800 Series Stocked Labels you see on pages 6-9 of this catalog.
- Fax or e-mail your order form, including label format and data needs.
- Initial order turnaround time varies; repeat orders are filled in 48 hours.
- We can print any image you need in black, including graphics, barcodes, etc.

Q-Service[®] for RFID: (Including DOD formats)

- Call 1-800-543-6650 and press 5 or e-mail qservice@averydennison.com for Q-Service or RFID order form.
- Choose from our full range of high quality RFID supplies, including 4" x 6", 4" x 2", 4" x 1" and specialty supply sizes, including DOD.
- Fax or e-mail your order form, including label format, RFID data to encode, and the bar code/human readable information to print.
- Initial order turnaround time varies; repeat orders are filled in 48 hours.

A complete library of Wal-Mart formats is available to meet Wal-Mart's EPC requirements.

Examples of pre-printed labels. Custom labels available.

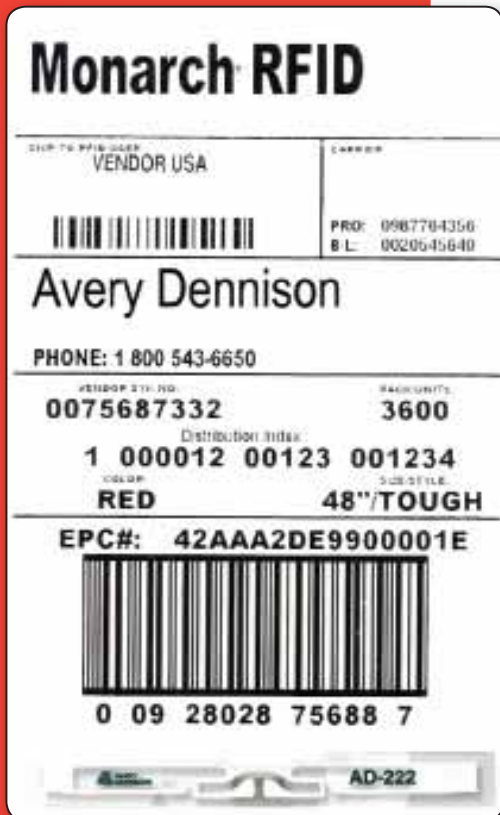

These are examples of real world challenges solved by the Avery Dennison supplies doctors

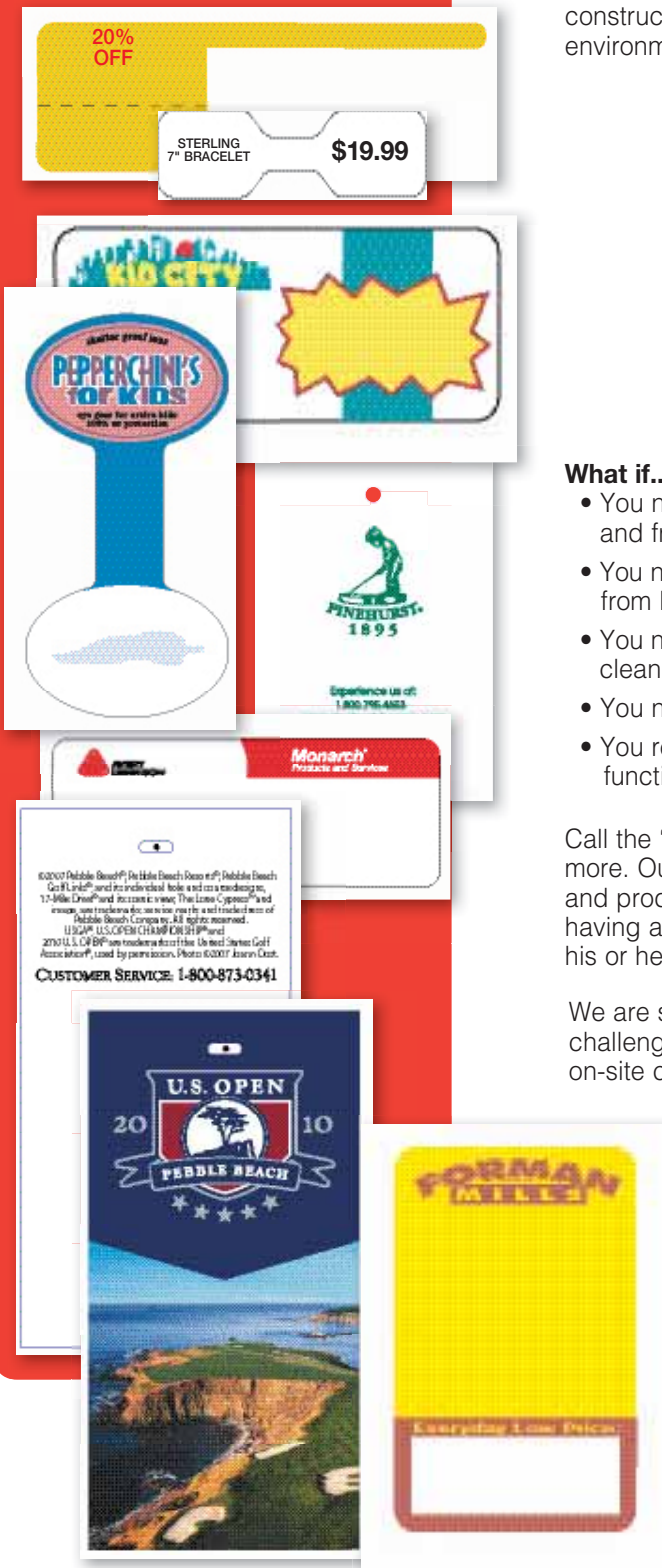

Avery Dennison's Supplies Technology Laboratory

Developing Customized Products to Your Specifications

Inside our supplies technology laboratory, our expert supplies engineers and technicians apply their knowledge using the latest technology, to construct customized label and tag solutions specific to your usage and environment. What are your most challenging tag or label problems?



What if...

- You need a thermal transfer label that holds up to high temperatures and friction?
- You need a bar coded security device to prevent a tote of merchandise from being opened prior to delivery?
- You need a label with superior adhesion and a surface that will withstand cleaning with high pressure and high temperature soap and water?
- You need a label or tag with a custom shape to fit your product?
- You require specific perforations for multiple detach-and-apply functions?

Call the "supplies doctors." They've solved all of these challenges and more. Our supplies technology chemists, engineers, laboratory technicians and product developers, are among the best and brightest in the industry, having an average of over 32 years experience, each holding degrees in his or her area of expertise, and several with multiple patent awards.

We are so confident that we can solve your toughest thermal label or tag challenge that we'll analyze your existing labels or provide you with an on-site consultation free of charge.

Call us today at 1-800-543-6650, press 5

Complete Printing Solutions for the Retail Supply Chain

- In Store
- Distribution Centers
- Logistics
- Manufacturing

**RFID, Barcode,
Human Readable—
We've Got the Solution!**



**Don't See What You Need in this Catalog?
There's Plenty More—Call Us!
1-800-543-6650, Press 5**

Monarch®
Products and Services

www.monarch.com

 **AVERY
DENNISON**

Monarch®

**Special Offer:
Ultra® Silver
Start-up
Package**



1.5" x 1.1"

See page 14 for other
standard label formats

Custom Formats available

**Start Bar Coding Today with the
Pathfinder® Ultra® Silver 6032™ Printer**

The Ultra Silver Printer is a simple, one-piece labeling solution. It's portable, so you can take the printer where you need it.

The Ultra Silver Start-up Package includes:

- Ultra Silver Printer
- Battery and charger
- Ten standard label formats
- One case of 1.2" x 1.1" labels

Special Package Price

List Price \$1,523 **Now \$999**

SAVE 34%

**To order, call 1-800-543-6650,
Press 5 www.monarch.com**

Monarch®
Products and Services

©2008 Avery Dennison. All rights reserved