



**2-IN-1 Cordless/Corded Iron
Model EP485**

USE AND CARE INSTRUCTIONS

Congratulations! You are the owner of the 2-IN-1 Cordless/Corded Iron. To fully enjoy the advantages of your appliance, please take a few minutes to read all the “Use & Care Instructions” and keep the instructions handy for easy reference. Please review the product warranty and mail the owner registration form.

EURO-PRO Operating LLC: 21 Lawrence Paquette Industrial Drive, Champlain, New York 12919
4400 Bois Franc, St. Laurent, Quebec H4S 1A7
Tel.: 1 (800) 798-7398

IMPORTANT SAFEGUARDS

When using your iron, basic safety precautions should always be followed, including the following:

1. Read all instructions before using the iron.
2. Use iron only for its intended use.
3. To protect against a risk of electrical shock, do not immerse iron or stand in water or other liquids.
4. The iron thermostat should always be turned to its lowest position before plugging or unplugging from outlet. Never yank cord to disconnect from outlet, instead grasp plug and pull to disconnect.
5. Do not allow cord to touch hot surfaces. Let iron cool completely before putting away.
6. Do not put vinegar or other descaling agents into the water reservoir.
7. Do not use chemically descaled water.
8. The cordset should not be allowed to touch the soleplate when it is hot.
9. Always disconnect iron from electrical outlet when filling iron with water or emptying and when not in use.
10. Do not operate iron with a damaged cord or if the iron has been dropped or damaged. To avoid the risk of electrical shock, do not disassemble the iron. Send it to an authorized **EURO-PRO Operating LLC** service center for examination and repair. Incorrect reassembly can cause a risk of electric shock when iron is used.
11. Close supervision is necessary for any appliance used by or near children. Do not leave iron unattended while connected or on an ironing board.
12. Burns can occur from touching hot metal parts, hot water or steam. Use caution when you turn a steam iron upside down as there may be hot water in the reservoir. Never direct steam at any person, especially when using the iron in a vertical position. The steam is very hot and can cause burns.
13. The use of accessory attachments not recommended by **EURO-PRO Operating LLC** may result in fire, electrical shock or personal injury.
14. Do not operate in the presence of explosive and/or flammable fumes.
15. Do not use iron outdoors.
16. This product is for household use only.

FOR HOUSEHOLD USE ONLY
SAVE THESE INSTRUCTIONS

SPECIAL INSTRUCTIONS

1. To avoid a circuit overload, do not operate another high-wattage appliance on the same circuit.
2. If an extension is absolutely necessary, a 15-ampere rated cord with a polarized plug should be used. Cords rated for less amperage may overheat. Care should be taken to arrange the cord so that it cannot be pulled on or tripped over.

POLARIZED PLUG This appliance has a polarized plug (one blade is wider than the other). As a safety feature, this plug will fit into a polarized outlet only one way. If the plug does not fit fully into the outlet, reverse the plug. If it still does not fit, contact a qualified electrician. Do not attempt to defeat this safety feature.

SAVE THESE INSTRUCTIONS

2-IN-1 CORDLESS/CORDED IRON

1. Temperature Control Dial
2. Variable Steam Control
3. Spray Button
4. Spray Nozzle
5. Burst of Steam Button
6. Water Filling Inlet Cover
7. Thermostat Light
8. Water Level Window
9. Stainless Steel Sole Plate
10. Soft Hand Grip
11. Power Base (unit)
12. Stand
13. 3 Position Switch
- 13A. Lock Position
- 13B. Cordless Position
- 13C. Cord Position
14. Auto-Off Light

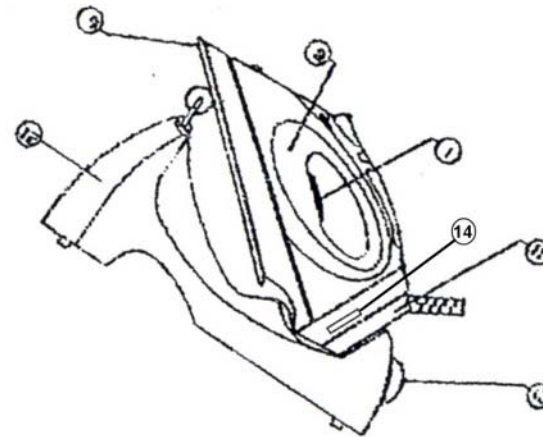
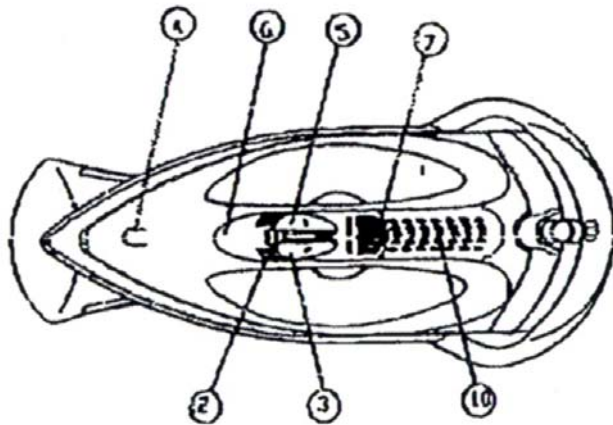

13A
Lock Position
to transport
and store your iron

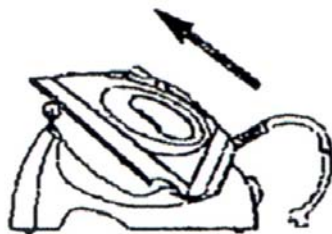

13B
Cordless Position
to iron without
a cord



13C
Cord Position
to iron with
a cord



BEFORE FIRST USE

Remove any labels, stickers or tags which may be attached to the body or soleplate of the iron before using the iron.

Read all instructions for use carefully. Always follow the Important Safeguards.

IMPORTANT

The first time an iron is used, some odor and small white particles may come out of the steam vents. This is perfectly normal and will cease to occur after the iron has been in use for a short while.

Before you start using your iron, follow the instructions in the manual and do the following in order to eliminate any odor and small white residue particles and to ensure optimum steam performance.

Fill the iron with regular tap water.

Set the temperature control dial at **its highest** and steam control at **'0'**.

When the thermostat light goes off to indicate that the iron has reached the selected temperature, set the steam control at **MAX**.

Keep the iron in a horizontal position and allow it to steam until the water runs out.

Press the steam burst button to eliminate white residue particles.

Repeat this procedure through 2 or 3 fillings of water.

CONNECTING THE IRON TO THE POWER SUPPLY

- Make sure that the variable steam control dial is set at '0'.
- Place the iron upright on the heel rest or on the stand (12).
- Select the required temperature setting on the temperature control dial.
- The red thermostat light (7) will come on indicating that the iron is heating up.
- When the red light goes out, the set temperature has been reached and the iron is ready to use.
- The thermostat light (7) will go on & off as the thermostat is switching the heating element on & off to maintain the selected temperature.

CHOOSING THE IRONING TEMPERATURE

Set the temperature dial according to the type of fabric .

- Synthetics
(low temperature)
- Silk, Wool
(medium temperature)
- Cotton, Linen
(high temperature)



Temperature Control Dial

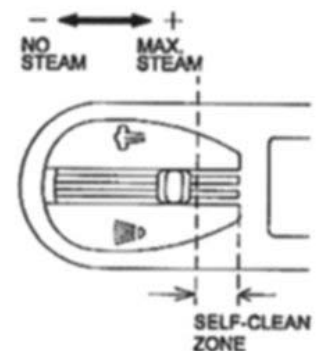









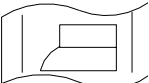

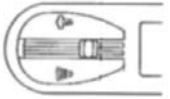





Variable Steam Control

Please note: Before starting to iron delicate fabrics, it is best to first test the temperature of the iron on a hem or an inside seam.

TO SELECT IRON TEMPERATURE, LINE UP TEMPERATURE SELECTED ON DIAL WITH THE RED TRIANGLE ON THE WATER TANK.

FABRIC TABLE

INSTRUCTIONS ON LABEL	FABRIC	TEMPERATURE CONTROL	STEAM CONTROL	BURST OF STEAM	SPRAY
					
	SYNTHETIC FIBERS, e.g. acryl, viscose polyamide (nylon) polyester	MIN •	0		
	SILK WOOL	• •	MINIMUM STEAM		
	COTTON LINEN	• • • MAX	MAXIMUM STEAM		
	Please note that  on the label means 'THIS ARTICLE CANNOT BE IRONED!'				

FILLING WITH WATER

- You can fill this iron with normal tap water.
- Remove the main plug from the wall outlet before filling the iron with water.
- Set the variable steam control (2) to position 0 (no steam).
- Set the 3-position switch (13) to position “cordless” (13B) and take the cordless iron from the stand. (see fig. 1)
- Place the iron horizontally and open the Water Filling Inlet Cover (6). Pour water into the water filling inlet (6) to a maximum of approximately 8 oz. (230ml). Use the water bottle with the spout for this purpose. (see fig. 2)
- Close the water filling inlet cover (6).

Cordless Position
To Iron Without
A Cord

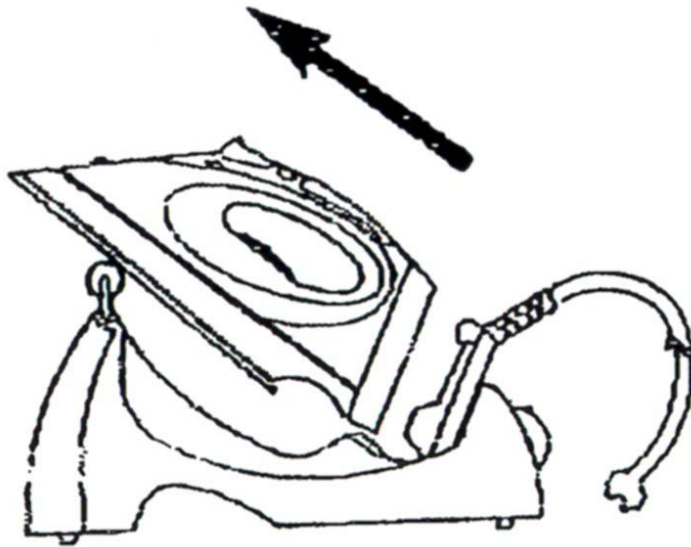

Fig. 1

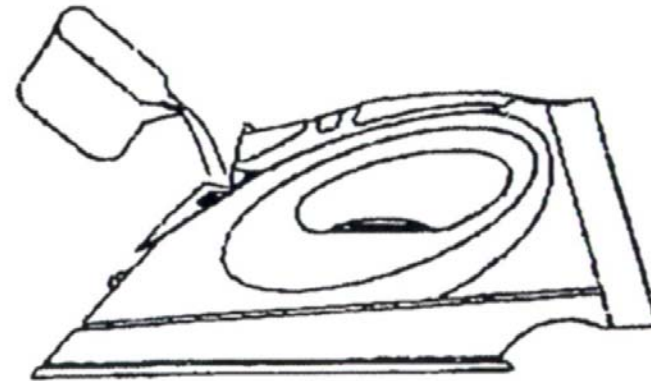

Fig. 2

IRONING WITH STEAM

- Make sure iron is unplugged from power source.
- Set the variable steam control to '0'.
- Fill the iron with water following the instructions for filling.
- Plug the cord into a 120 Volt AC electrical outlet.
- Set the temperature control dial within the steam area i.e. '•••'.
- Make sure that the iron has reached the selected temperature with the variable steam control set at '0'.

IMPORTANT: Do not open the steam control until the thermostat light goes off to indicate that the selected temperature within the steam range has been reached. If you move the variable steam control up from '0' before the correct temperature is reached, the iron will drip water.

- The variable steam control offers a few different settings:

PLEASE NOTE: For maximum steam the temperature control dial should be set at ••• . The temperature control should be set at the beginning only for very delicate fabrics requiring very gentle steam (setting •).

- Steam is produced as soon as the iron is held in a horizontal position.
- Steam will stop coming out when the iron is put on its heel in a vertical position or by turning the steam control dial to '0'.

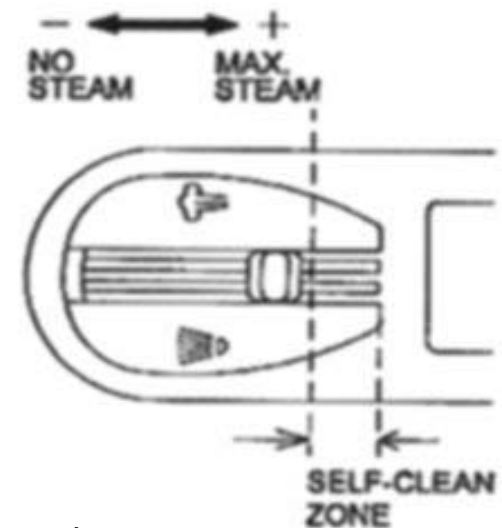

SETTING THE TEMPERATURE

- Place the iron on the stand. (Fig. 3)
- Insert the plug into the wall outlet.
- Set the appropriate ironing temperature indicated in the ironing instructions or in the fabric table by means of the temperature dial (1). (Fig. 4)
- Thermostat light (7) will now come on. (Fig. 5)
- When the thermostat light (7) has gone out and has come on again you can start ironing.
- The thermostat light (7) will come on from time to time during corded ironing.
- If you set the temperature control (1) to a lower setting after ironing at a high temperature, do not recommence ironing before the thermostat light (7) has come on and then has gone out again.

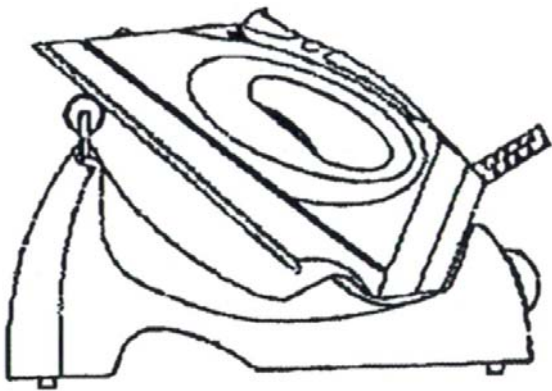

Fig. 3

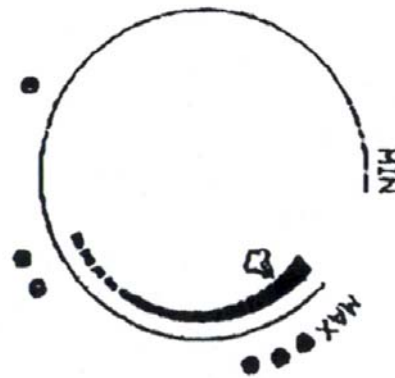

Fig. 4

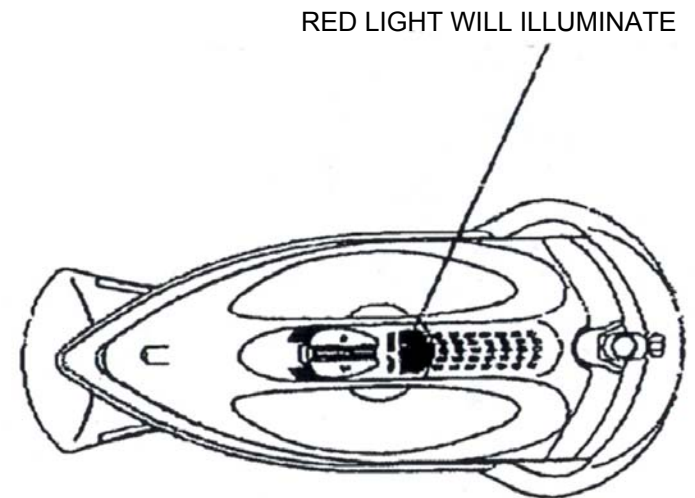

Fig. 5

CORDED IRONING

- Set the 3-position switch (13) to position 13C. (Fig. 6)
- Take the iron with the power unit (11) from the stand. (Fig. 7)
- Either place iron on heel rest or on the stand (12) when you interrupt ironing.

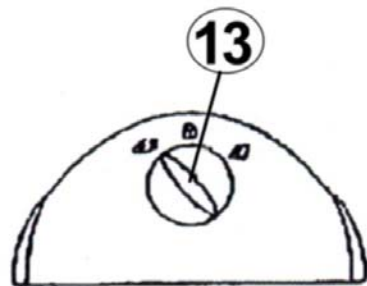

Fig. 6

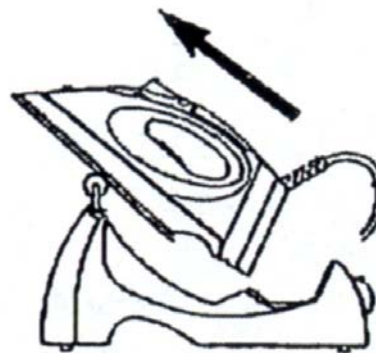

Fig. 7

CORDLESS IRONING

- Set the 3-position switch (13) to position 13B. (Fig. 8)
- Take the iron without the power base (11) from the stand. (Fig. 9)
- Always place the iron on the stand (12) when you interrupt ironing.
- For optimal ironing performance, the iron should be replaced to the stand for heating up to the set temperature. As soon as the soleplate has regained the set temperature, the thermostat light (7) will go off.
- When cordless steam ironing for a considerable amount of time, the soleplate might cool down more than required. For that reason, we advise you to always use the iron in the corded mode if you intend to steam iron for a considerable time.

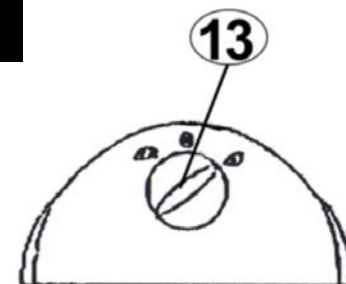

Fig. 8



Fig. 9

WATER SPRAY

- Use the spray button to add moisture to stubborn wrinkles.
- First make sure that there is water in the tank.
- Press the spray button (3) slowly to get a jet spray. (Fig. 10)
- Press the spray button strongly and quickly to get a mist.
- Please note: If spray does not come out when you press the spray button, cover the spray opening with your finger and press a few times.

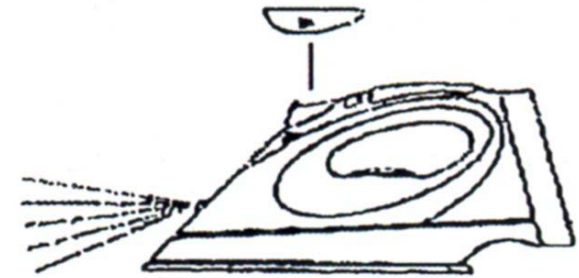

Fig. 10

IRONING WITH STEAM

- As indicated on the temperature control dial (1) and the fabric table, steam ironing is only possible at the higher ironing temperature settings: •• for moderate or ••• for maximum steam.
- With conventional steam irons, water may leak from the soleplate if too low a temperature has been selected. However, your new steam iron has an “Anti-Drip” feature which will automatically stop the iron from steaming at too low a temperature. When this happens, you will hear a “Click”. Set the temperature control dial (1) to the advised position. Steaming will restart when the appropriate temperature has been reached.
- Ensure that there is enough water in the water reservoir.
- Place the iron on its stand (12) and set the temperature control dial (1) to the required position within the “steam area” (•• for moderate or ••• for maximum steam). (Fig. 11)
- After the thermostat light (7) has gone out and has come on again, you may start ironing.
- Slide the variable steam control (2) to the required position. (Fig. 12)

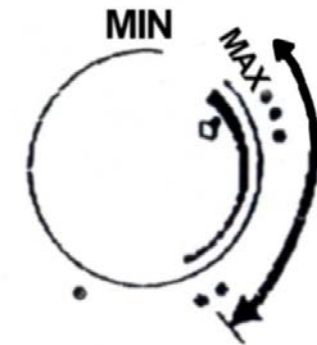

Fig. 11

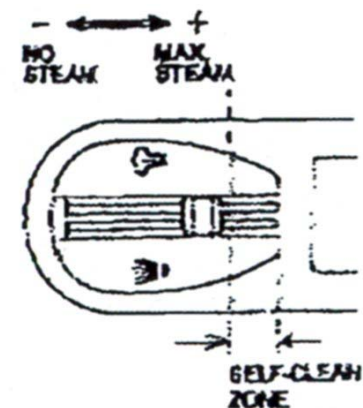

Fig. 12

TO EMPTY THE IRON

- Always empty iron after each usage.
- After using the iron, turn the variable steam control to '0' and the temperature control dial to 'minimum'.
- Unplug the iron from the power source.
- Set variable steam control to 'MAX'.
- Open the water inlet cover and turn the iron up-side down over the sink with the tip pointing downward and allow the water to flow from the opening.
- Set variable steam control to '0'.
- Allow iron to cool on the iron rest before storing.

WARNING: Use caution when you turn the iron up-side down - there may be hot water in the reservoir. Burns can occur from touching hot metal parts, hot water or steam.

ELECTRONIC AUTOMATIC SHUT-OFF

Your **EURO-PRO** 2-in-1 Cordless/Corded Iron is equipped with an electronic auto shut-off. The electronic auto-off switches the iron off if it has been standing unmoved for approximately 8 minutes. A red light will flash when the iron switches itself off. To switch the iron back on again, shake the iron.

CAUTION: Do not use the auto shut-off feature as a substitute for turning the iron off and unplugging the iron when not in use.

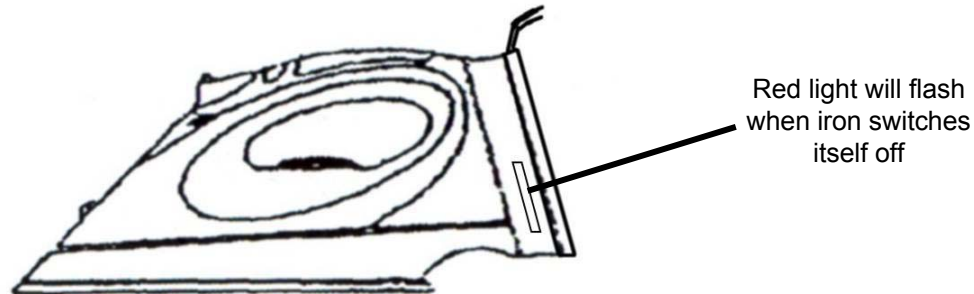

SELF-CLEANING

It is important to apply “Self-Cleaning” at least every two weeks to remove scale, etc. The harder the water the more the iron should be self-cleaned.

or

In order to remove calcium and built-up particles, the self-cleaning system should be run at least once a month.

- Set the variable steam control (2) to position “0”.
- Open the water filling inlet cover (6) and fill the water reservoir up to the Max indication.
- Close the water filling inlet cover (6) and place the iron on its stand (12). Plug unit into wall outlet and wait until the iron heats up and the thermostat light (7) goes off and then comes on again.
- Set the 3-position switch to the cordless position (13B) and remove the iron from the stand (12) with the power base (11).
- Hold the iron horizontally over the sink and slide the variable steam control button (2) to the “Self-Clean” zone. (Fig. 13)
- Boiling water and steam will now be ejected from the holes in the soleplate (9). The impurities and scale are washed away with it.
- Move the iron back and forth as this happens.
- Slide the variable steam control button (2) to the “0” position after one minute or when the water reservoir is empty.
- Place the iron back on its stand (12) to cool down.

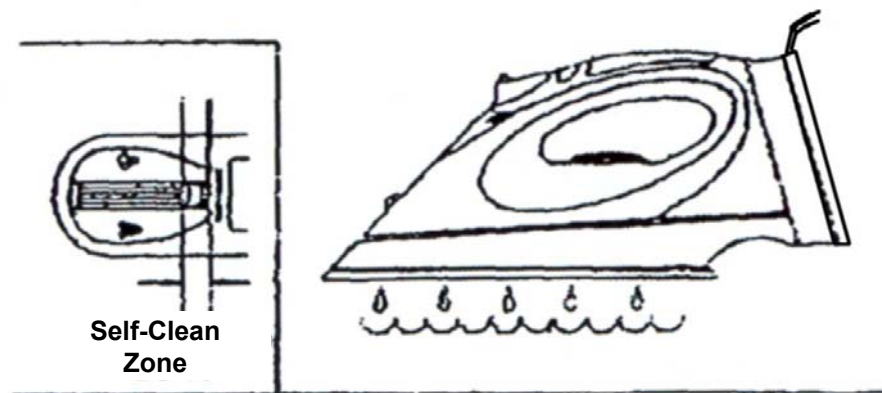
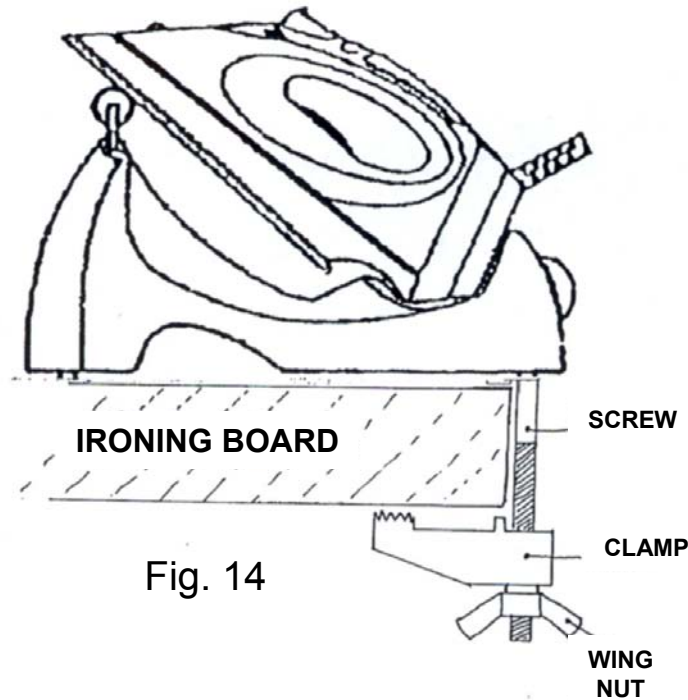

Fig. 13

ATTACHING IRON TO THE IRONING BOARD

Your iron is equipped with a clamp that can be used to attach the iron stand (12) to your ironing board (or any other suitable surface). (Fig. 14.)

- Rotate the clamp 90°, so that it points down.
- Place the iron stand (12) next to the edge of the table with the clamp on the bottom.
- Turn the wing nut clockwise and then tighten it to the ironing board or table.
- Reverse the process when finished ironing to remove the iron from the ironing board or table.



CLEANING, STORAGE & MAINTENANCE

- Always turn the variable steam control to '0' after you have emptied the water tank.
- Allow iron to cool down.
- Always store the iron on the metal iron rest or in an upright position on it's heel rest to protect the soleplate.
- From time to time clean the exterior with a damp cloth and wipe dry.
- If you use spray starch, wipe the soleplate occasionally with a soft damp cloth to prevent the forming of a deposit.
- If the iron has not been used for a few weeks, hold the iron horizontally and allow it to steam for 2 minutes before ironing.

WARNING: The anti-drip function reduces water dripping and water stains. It does not prevent water dripping or water stains if you press the steam burst button too often or if temperature is too low. The amount of water droplets will eventually decrease after iron is used for 2 to 3 tankfuls of steaming and ironing.

Iron Troubleshooting

Problem	Potential Reasons & Solutions
Iron does not heat	<ul style="list-style-type: none"> • Iron should be plugged into a 120V AC electrical outlet only. Make sure that the plug is securely in the socket. • Thermostat set too low. Turn to higher setting.
Thermostat ready light goes On and Off	<ul style="list-style-type: none"> • This is normal. The light goes On and Off as the thermostat is switching the heating element On and Off to maintain the selected temperature.
Some odor or small particles come out of steam vents of new iron	<ul style="list-style-type: none"> • This is normal. Follow instructions for first use and allow iron to steam through 2-3 fillings & press the steam burst button occasionally to eliminate small white particles.
Iron does not steam	<ul style="list-style-type: none"> • Water tank may be empty or water level is very low. Add water. • Make sure that the temperature control dial and the variable steam control are correctly set. For maximum steam, (setting 'Max' on steam control), temperature control dial should be set on '•••'. • Always allow the iron to reach the selected temperature with the steam setting at '0'. Make sure the temperature control dial is set in the correct steam area and the steam control is <u>not</u> on '0'. For more steam, turn temperature dial to higher setting. e.g. '•••' and the steam control to 'Max'. • If temperature setting and steam control setting are correct and there is no steam, <u>gently</u> tap the soleplate on the ironing board a few times. Move the variable steam control from '0' to 'Max' a few times.
Water droplets coming from steam vents	<ul style="list-style-type: none"> • Iron may not be hot enough. Set thermostat to the 'max' position. Always allow iron sufficient time to heat up (thermostat light goes off) before activating the variable steam control. • Overuse of steam burst. Allow more time between each burst. • Iron may have been overfilled. Turn iron off, empty water and follow instructions for filling. • Steam performance may be low if iron requires seasoning. Use regular tap water for 1 or 2 tanks until steam performance improves.

IMPORTANT SERVICE INFORMATION

In the event that your iron fails to operate properly or if your iron needs servicing

DO NOT RETURN IT TO THE STORE

First check the troubleshooting guide on the back of this page and make sure that you have followed all the instructions in the operating manual. If your iron still does not operate properly, send your iron, postage prepaid, together with \$9.50 to cover the cost of return shipping & handling and **a copy of your sales receipt to:**

Warranty Dept.

In U.S. ***EURO-PRO Operating LLC***
21 Lawrence Paquette Ind. Dr.
Champlain, N. Y. 12919

In Canada: ***EURO-PRO Operating LLC***
4400 Bois Franc
St. Laurent, Quebec H4S 1A7

Tel: (800) 798-7398

If the warranty period has expired, please send your iron postage pre-paid to the Service Dept. of *EURO-PRO Operating LLC* at the above address. You will be advised of the cost of repair before any servicing is done unless you enclose a note indicating that you would like us to proceed with the repairs and return the iron to you C.O.D.

DO NOT FORGET TO ENCLOSE YOUR NAME, ADDRESS, TELEPHONE NUMBER AND COPY OF SALES RECEIPT.

ONE YEAR LIMITED WARRANTY

EURO-PRO Operating LLC warrants this product to be free from defects in material and workmanship for a period of one (1) year from the date of purchase. The liability of **EURO-PRO Operating LLC** is limited solely to the repair or replacement of the product at **EURO-PRO's** option. This warranty does not cover damage caused by misuse, negligence, use on improper current or voltage, use contrary to operating instructions or disassembly, repair or alteration by any person other than an authorized **EURO-PRO Operating LLC** service station.

Product repair or replacement, at our option, is your sole remedy. This warranty excludes all other legal and/or conventional warranties. The responsibility of **EURO-PRO Operating LLC**, if any, is limited to the specific obligations expressly assumed by it under the terms of the limited warranty. In no event is **EURO-PRO Operating LLC** liable for incidental or consequential damages of any nature whatsoever. Some States do not permit the exclusion or limitation of incidental or consequential damages, so the above may not apply to you. This warranty gives you specific legal rights which vary from state to state.

If you have a claim under this warranty or if you require service
DO NOT RETURN THIS PRODUCT TO THE STORE!

Send the product , postage prepaid to our factory service center: US: **Warranty Department
EURO-PRO Operating LLC
21 Lawrence Paquette Ind. Dr.
Champlain, N. Y. 12919**

**CANADA: Warranty Department
EURO-PRO Operating LLC
4400 Bois Franc
St. Laurent, QC H4S 1A7**

Please include a copy of your sales receipt, \$9.50 to cover the cost of return shipping & handling and a letter explaining the nature of your difficulty. **Do not forget to enclose your name, address and telephone number.**

If the warranty period has expired, please send your iron postage pre-paid to: US: **Service Dept
EURO-PRO Operating LLC
21 Lawrence Paquette Ind. Dr.
Champlain, N.Y. 12919**

**CANADA: Service Dept.
EURO-PRO Operating LLC
4400 Bois Franc
St. Laurent, QC H4S 1A7**

You will be advised of the cost of repair before any servicing is done unless you enclose a note indicating that you would like us to proceed with the repairs and return the iron to you C.O.D.



.....

PRODUCT REGISTRATION CARD

Please complete and return within ten (10) days of purchase. The registration will enable us to contact you in the event a product defect is discovered. By returning this card you acknowledge to have read and understood the instructions for use, and warnings set forth in the accompanying instructions.

RETURN TO: **EURO-PRO Operating LLC**, 21 LAWRENCE PAQUETTE INDUSTRIAL DRIVE, CHAMPLAIN, N.Y. 12919

IN CANADA: **EURO-PRO Operating LLC**, 4400 BOIS FRANC, ST. LAURENT, QUE., H4S 1A7

PURCHASER:

ADDRESS:

DATE OF PURCHASE: MODEL: **EP485** SERIAL NO:

NAME AND ADDRESS OF STORE: