



Thank you for choosing Philips.

Need help fast?

Read your Quick Use Guide and/or Owner's Manual first for quick tips that make using your Philips product more enjoyable.

If you have read your instructions and still need assistance, you may access our online help at

www.philips.com/support
or call

1-888-PHILIPS (744-5477)
while with your product.



Philips vous remercie de votre confiance.

Besoin d'une aide rapide?

Les Guide d'utilisation rapide et Manuel de l'utilisateur regorgent d'astuces destinées à simplifier l'utilisation de votre produit Philips. Toutefois, si vous ne parvenez pas à résoudre votre problème, vous pouvez accéder à notre aide en ligne à l'adresse

www.philips.com/support
ou formez le

1-800-661-6162 (Francophone)
1-888-PHILIPS (744-5477) (English speaking)

Veillez à avoir votre produit à portée de main.



Gracias por escoger Philips

Necesita ayuda inmediata?

Lea primero la Guía de uso rápido o el Manual del usuario, en donde encontrará consejos que le ayudarán a disfrutar plenamente de su producto Philips.

Si después de leerlo aún necesita ayuda, consulte nuestro servicio de asistencia en línea en

www.philips.com/support
o llame al teléfono

1-888-PHILIPS (744-5477)
y tenga a mano el producto.



PHILIPS



Philips
MCM275

Note : This equipment has been tested and found to comply with the limits for a Class B digital device, pursuant to part 15 of the FCC Rules. These limits are designed to provide reasonable protection against harmful interference in a residential installation. This equipment generates, uses, and can radiate radio frequency energy and, if not installed and used in accordance with the instruction manual, may cause harmful interference to radio communications. However, there is no guarantee that interference will not occur in a particular installation. If this equipment does cause harmful interference to radio or television reception, which can be determined by turning the equipment off and on, the user is encouraged to try to correct the interference by one or more of the following measures :

- Relocate the receiving antenna.
- Increase the separation between the equipment and receiver
- Connect the equipment into an outlet on a circuit different from that to which the receiver is connected.
- Consult the dealer or an experienced radio/TV technician for help.

IMPORTANT !

modifications not authorized by the manufacturer may void users authority to operate this device.

Remarque : Cet équipement a été testé et a été certifié conforme aux limites imposées pour un appareil numérique de Classe B, conformément à la partie 15 des règlements FCC. Ces limites sont définies aux fins d'assurer une protection raisonnable contre les interférences nuisibles dans une installation résidentielle. Cet équipement génère, utilise et émet des fréquences radio qui, en cas d'une mauvaise installation ou d'une utilisation non-conforme aux instructions de ce manuel d'utilisation peuvent causer des interférences nuisibles aux communications radio. Il n'y a toutefois aucune garantie que des interférences nuisibles ne se produiront pas dans une installation donnée. Si cet équipement cause des interférences nuisibles avec votre poste radio ou de télévision, ce que vous pouvez déterminer en éteignant et en rallumant votre équipement, il est conseillé à l'utilisateur d'essayer de pallier à ces interférences nuisibles en prenant l'une ou l'autre des mesures suivantes:

- Changez la position de l'antenne de réception.
- Augmentez la séparation entre l'équipement et le récepteur.
- Branchez l'équipement sur une source d'alimentation différente de celle sur laquelle le récepteur est branché.
- Consultez votre distributeur ou un technicien qualifié en la matière pour assistance.

IMPORTANTE !

las modificaciones no autorizadas por el fabricante pueden anular la autoridad de los usuarios para utilizar este aparato.

Nota : Este aparato ha sido probado y cumple con los límites correspondientes a un aparato digital de Clase B, según la parte 15 de las Normas FCC. Estos límites han sido diseñados para facilitar suficiente protección frente a interferencias perjudiciales en una instalación residencial. Este aparato genera, utiliza y puede emitir energía de frecuencias de radio y, si no se instala y utiliza según el manual de instrucciones, puede provocar interferencias perjudiciales en las comunicaciones de radio. Sin embargo, no existe garantía de que las interferencias no ocurrirán en una instalación particular. Si este aparato provoca interferencias perjudiciales en la recepción de radio o televisión, que se puede identificar encendiendo y apagando el aparato, recomendamos al usuario que intente solucionar las interferencias siguiendo una o más de las siguientes medidas:

- Cambie la posición de la antena receptora.
- Aumente la separación entre el aparato y el receptor.
- Conecte el aparato a una toma de un circuito diferente al que está conectado el receptor.
- Consulte con el distribuidor o un técnico de radio/TV con experiencia para que le ayuden.

¡IMPORTANTE!

modificações não autorizadas pelo fabricante, podem causar danos na operação deste aparelho.

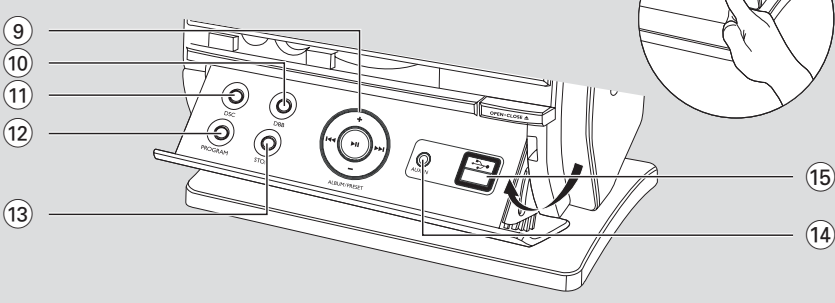
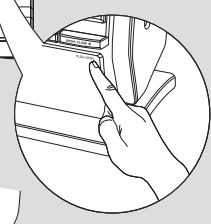
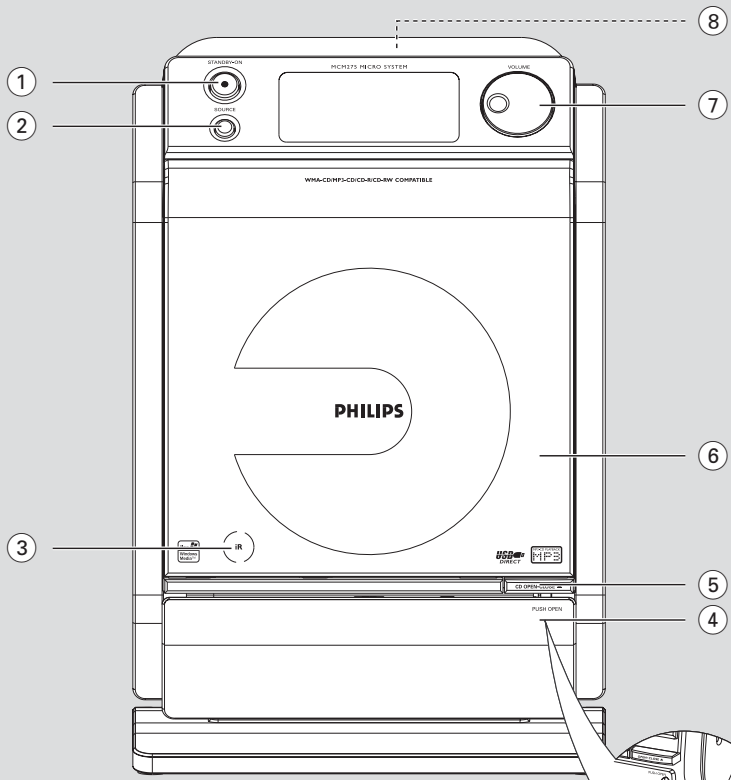

IMPORTANT SAFETY INSTRUCTIONS

1. **Read these instructions.**
2. **Keep these instructions.**
3. **Heed all warnings.**
4. **Follow all instructions.**
5. **Do not use this apparatus near water.**
6. **Clean only with a piece of dry cloth.**
7. **Do not block any ventilation openings. Install in accordance with the manufacturer's instructions.**
8. **Do not install near any heat sources**

such as radiators, heat registers, stoves, or other apparatus (including amplifiers) that produce heat.

9. **Do not defeat the safety**

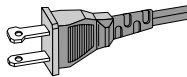

AC Polarized Plug

purpose of the polarized or

grounding-type plug. A polarized plug has two blades with one wider than the other. A grounding type plug has two blades and a third grounding prong. The wide blade or the third prong are provided for your safety. If the provided plug does not fit into your outlet, consult an electrician for replacement of the obsolete outlet.

10. **Protect the power cord** from being walked on or pinched, particularly at plugs, convenience receptacles, and the point where they exit from the apparatus.
11. **Only use attachments/accessories** specified by the manufacturer:

12.  **Use only with the cart**, stand, tripod, bracket, or table specified by the manufacturer or sold with the apparatus. When a cart is used, use caution when moving the cart /apparatus combination to avoid injury from tip-over.

13. **Unplug this apparatus** during lightning storms or when unused for long periods of time.

14. **Refer all servicing** to qualified service personnel. Servicing is required when the apparatus has been damaged in any way, such as power-supply cord or plug is damaged, liquid has been spilled or objects have fallen into the apparatus, the apparatus has been exposed to rain or moisture, does not operate normally, or has been dropped.

15. **Battery usage CAUTION** – To prevent battery leakage which may result in bodily injury, property damage, or damage to the unit:

Install **all** batteries correctly, **+** and **-** as marked on the unit.

Do not mix batteries (**old** and **new** or **carbon** and **alkaline**, etc.).

Remove batteries when the unit is not used for a long time.

16. **Apparatus shall not be exposed to dripping or splashing.**
17. **Do not place any sources of danger on the apparatus** (e.g. liquid filled objects, lighted candles).

18. This product may contain lead and mercury. Disposal of these materials may be regulated due to environment considerations.

For disposal or recycling information, please contact your local authorities or the Electronic Industries Alliance: www.eiae.org.

EL 6475-S004: 03/12

Class II equipment symbol 
This symbol indicates that the unit has a double insulation system

Return your Product Registration Card today to get the very most from your purchase.

Registering your model with PHILIPS makes you eligible for all of the valuable benefits listed below, so don't miss out. Complete and return your Product Registration Card at once to ensure:

*Proof of Purchase

Returning the enclosed card guarantees that your date of purchase will be on file, so no additional paperwork will be required from you to obtain warranty service.

*Product Safety Notification

By registering your product, you'll receive notification - directly from the manufacturer - in the rare case of a product recall or safety defect.

*Additional Benefits of Product Ownership

Registering your product guarantees that you'll receive all of the privileges to which you're entitled, including special money-saving offers.

Know these safety symbols



This "bolt of lightning" indicates uninsulated material within your unit may cause an electrical shock. For the safety of everyone in your household, please do not remove product covering.



The "exclamation point" calls attention to features for which you should read the enclosed literature closely to prevent operating and maintenance problems.

For Customer Use

Enter below the Serial No. which is located on the rear of the cabinet. Retain this information for future reference.

Model No. _____

Serial No. _____

WARNING: TO PREVENT FIRE OR SHOCK HAZARD, DO NOT EXPOSE THIS EQUIPMENT TO RAIN OR MOISTURE.

CAUTION: To prevent electric shock, match wide blade of plug to wide slot, fully insert.

PHILIPS Visit our World Wide Web Site at <http://www.usasupport.philips.com>

PHILIPS

***Congratulations on your purchase,
and welcome to the “family!”***

Dear PHILIPS product owner:

Thank you for your confidence in PHILIPS. You've selected one of the best-built, best-backed products available today. We'll do everything in our power to keep you happy with your purchase for many years to come.

As a member of the PHILIPS “family,” you're entitled to protection by one of the most comprehensive warranties and outstanding service networks in the industry. What's more, your purchase guarantees you'll receive all the information and special offers for which you qualify, plus easy access to accessories from our convenient home shopping network.

Most importantly, you can count on our uncompromising commitment to your total satisfaction.

All of this is our way of saying welcome - and thanks for investing in a PHILIPS product.

P.S. To get the most from your PHILIPS purchase, be sure to complete and return your Product Registration Card at once.

| | |
|----------------|----|
| English | 8 |
| Français | 32 |
| Español | 59 |

Canada

English:

This digital apparatus does not exceed the Class B limits for radio noise emissions from digital apparatus as set out in the Radio Interference Regulations of the Canadian Department of Communications.

Français:

Cet appareil numérique n'émet pas de bruits radioélectriques dépassant les limites applicables aux appareils numériques de Class B prescrites dans le Règlement sur le Brouillage Radioélectrique édicté par le Ministère des Communications du Canada.

General Information

| | |
|---------------------------------|---|
| Supplied accessories | 9 |
| Environmental information | 9 |
| Safety information | 9 |

Controls

| | |
|---------------------------|-------|
| Controls on the set | 10 |
| Remote control | 11-12 |

Installation

| | |
|--|-------|
| Placing MCM275 | 12 |
| Mounting stand onto the set | |
| Mounting MCM275 onto walls | |
| Rear connections | 13-14 |
| Speaker connections | |
| Antenna connections | |
| Connecting an additional appliance | 14-15 |
| Connecting a USB device | |
| Connecting a non-USB device | |
| Using AC power | 15 |

Preparations

| | |
|--------------------------------|----|
| Using the remote control | 16 |
| Setting the clock | 16 |

Basic Functions

| | |
|---|----|
| Switching on/off the set and selecting functions | 17 |
| Switching between Standby and ECO POWER mode | 17 |
| Auto-standby | 17 |
| Volume control | 18 |
| Volume adjustment | |
| MUTE | |
| Sound control | 18 |
| DSC | |
| DBB | |
| Displaying the clock | 18 |

CD

| | |
|---|-------|
| Discs for playback | 19 |
| Playing discs | 19-20 |
| Selecting and searching | 20 |
| Selecting a different track | |
| Finding a passage within a track during playback | |
| Programming tracks | 21 |
| Reviewing the program | |
| Erasing the program | |
| Different play modes: REPEAT, SHUFFLE | 22 |
| Display track information (MP3/WMA only) | 22 |

Tuner

| | |
|----------------------------------|----|
| Tuning to radio stations | 23 |
| Programming radio stations | 23 |
| Autostore:Automatic programming | |
| Manual programming | |
| To listen to a preset station | |

USB

| | |
|---------------------------------------|-------|
| Using a USB mass storage device | 24-25 |
| Playing a USB mass storage device | |

AUX

| | |
|---|----|
| AUX (Listening to an external source) | 25 |
|---|----|

Timer

| | |
|---|----|
| Setting the timer | 26 |
| Activating and deactivating TIMER | 26 |

SLEEP

| | |
|-------|----|
| | 26 |
|-------|----|

Specifications

| | |
|-------|----|
| | 27 |
|-------|----|

Maintenance

| | |
|-------|----|
| | 27 |
|-------|----|

Troubleshooting

| | |
|-------|-------|
| | 28-29 |
|-------|-------|

How to mount your MCM275 onto walls

| | |
|-------|----|
| | 30 |
|-------|----|

Supplied accessories

- 2 speaker boxes including 2 speaker cables
- remote control (with 1 x CR2025 battery)
- MW loop antenna
- FM wire antenna
- stand
- mounting kit

Environmental Information

All unnecessary packaging has been omitted. We have tried to make the packaging easy to separate into three materials: cardboard (box), polystyrene foam (buffer) and polyethylene (bags, protective foam sheet).

Your system consists of materials which can be recycled and reused if disassembled by a specialized company. Please observe the local regulations regarding the disposal of packaging materials, exhausted batteries and old equipment.

The set complies with the FCC-Rules, Part 15 and with RSS-210 of Industry Canada.

Operation is subject

to the following two conditions:

- 1. this device may not cause harmful interference, and**
- 2. this device must accept any interference received, including interference that may cause undesired operation.**

The set complies with the FDA/DHHS Rule 21 CFR Subchapter J in effect at Date of Manufacture

Safety Information

- Place the system on a flat, hard and stable surface.
- Place the system in a location with adequate ventilation to prevent internal heat build-up in your system. Allow at least 10 cm (4 inches) clearance from the rear and the top of the unit and 5 cm (2 inches) from each side.
- The ventilation should not be impeded by covering the ventilation openings with items, such as newspapers, table-cloths, curtains, etc.
- Do not expose the system, batteries or discs to excessive moisture, rain, sand or heat sources caused by heating equipment or direct sunlight.
- No naked flame sources, such as lighted candles, should be placed on the apparatus.
- No objects filled with liquids, such as vases, shall be placed on the apparatus.
- If the system is brought directly from a cold to a warm location, or is placed in a very damp room, moisture may condense on the lens of the disc unit inside the system. Should this occur; the CD player would not operate normally. Leave the power on for about one hour with no disc in the system until normal playback is possible.
- The mechanical parts of the set contain self-lubricating bearings and must not be oiled or lubricated.
- **When the system is switched to Standby mode, it is still consuming some power. To disconnect the system from the power supply completely, remove the AC power plug from the wall socket.**

Controls on the set (illustrations on page 3)

① STANDBY-ON

- press briefly to switch the set on or off (standby/ECO POWER);
- **In standby or Eco Power mode:** press and hold to toggle between Standby and ECO POWER mode (power-saving mode)
- **Red indicator:** lights up red when the set is switched to ECO POWER mode

② SOURCE

- selects sound source **CD, USB, TUNER** or **AUX**
- **In standby or Eco Power mode:** switches the set on and selects sound source **CD, USB, TUNER** or **AUX**

③ IR

- sensor for the infrared remote control
- **Helpful hints:** Always point the remote control towards this sensor.

④ PUSH OPEN

- push to unfold or fold the control panel

⑤ CD OPEN • CLOSE ▲

- opens/closes the CD door

⑥ CD door



⑦ VOLUME

- adjusts the volume level
- **Clock/Timer:** adjusts the hours and minutes

⑧

- 3.5 mm headphone socket
- **Helpful hints:**
 - Adjust the volume to a moderate level before you plug in the headphones.
 - Connecting headphones will switch off the speakers.

⑨ ALBUM/ PRESET + /-

- **CD/USB:** selects albums (for MP3/WMA only)
- **TUNER:** selects a preset radio station
- 
- **CD/USB:** skips or searches CD tracks/titles backwards/forwards
- **Tuner:** tunes to radio stations
- 
- **CD/USB:** starts or pauses playback

⑩ DBB (Dynamic Bass Boost)

- turns the bass enhancement on/off

⑪ DSC (Digital Sound Control)

- selects predefined sound settings: **ROCK, JAZZ, POP, CLASSIC**

⑫ PROGRAM

- **CD/USB:** programs tracks
- **Tuner:** programs preset radio stations

⑬ STOP

- **CD/USB:** stops playback; erase a program

⑭ AUX-IN

- connects to the AUDIO OUT jack on the external appliance

⑮

- jack for the external USB mass storage device

Remote control

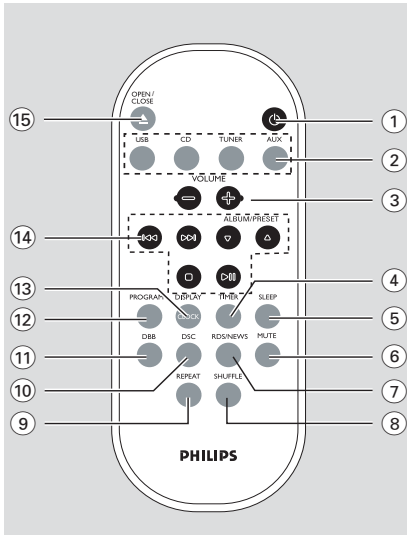

Notes for remote control:

– First select the source you wish to control by pressing one of the source select keys on the remote control (for example **CD, TUNER**).

– Then select the desired function (for example **▶ II**, **◀ ▶**).

① **Power**

- press briefly to switch the set on or off (standby/ECO POWER);
- **In standby or Eco Power mode:** press and hold to toggle between Standby and ECO POWER mode (power-saving mode)

② **Source buttons**

USB

- selects **USB** source
- **In standby or Eco Power mode:** switches the set on and selects **USB** source.

CD

- selects **CD** source
- **In standby or Eco Power mode:** switches the set on and selects **CD** source.

TUNER

- selects **TUNER** source and toggles between the wavebands: FM and AM
- **In standby or Eco Power mode:** switches the set on and selects **TUNER** source

AUX

- selects the audio input from an additional connected appliance
- **In standby or Eco Power mode:** switches the set on and selects the audio input from an additional connected appliance

③ **VOLUME +/-**

- adjusts the volume level
- **Clock/Timer:** adjusts the hours and minutes

④ **TIMER**

- displays the timer setting
- switches the timer on/off
- enters the timer setting mode (press and hold for more than 2 seconds)

⑤ **SLEEP**

- set the sleep timer

⑥ **MUTE**

- switches the sound off temporarily

⑦ **RDS/NEWS**

no function on this set

⑧ **SHUFFLE**

- selects random playback

⑨ **REPEAT**

- selects continuous playback

⑩ **DSC (Digital Sound Control)**

- selects predefined sound settings: **ROCK, JAZZ, POP, CLASSIC**

⑪ **DBB (Dynamic Bass Boost)**

- turns the bass enhancement on/off

⑫ **PROGRAM**

- **CD/USB:** programs tracks
- **Tuner:** programs preset radio stations

⑬ **DISPLAY/CLOCK**

- **Clock:** - displays the set time
 - **In standby mode:** enters the clock setting mode (press and hold for more than 2 seconds)
- **TUNER/Audio CD:** switches between clock display and playback display
- **MP3/WMA files:** displays disc information during playback

- ⑭ **I◀◀ / ▶▶I**
 - **CD/USB:** skips or searches CD tracks backwards/forwards
 - **Tuner:** tunes to radio stations
- ALBUM/ PRESET ▲ / ▼**
 - **CD/USB:** selects the next/previous album (for MP3/WMA only)
 - **TUNER:** selects a preset radio station
- ▶ II**
 - **CD/USB:** starts or pauses playback
- - **CD/USB:** stops playback; erase a program
- ⑮ **OPEN • CLOSE ▲**
 - opens/closes the CD door

Placing MCM275

With the detachable stand and by-packed wall mounting kit, MCM275 allows you to place it in two ways: **on desktops with stand** or **on walls without stand**.

Mounting stand onto the set

MCM275 is equipped with a stand. To mount the stand onto the set,

- ① Put MCM275 on a flat and firm surface, rear side facing up
- ② As shown, align the stand to the slots at set's bottom, ▼ **FRONT** facing down

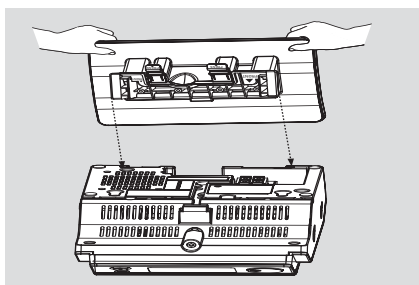

- ③ Push the stand down into the slots
→ When the stand is in place, you will hear a click

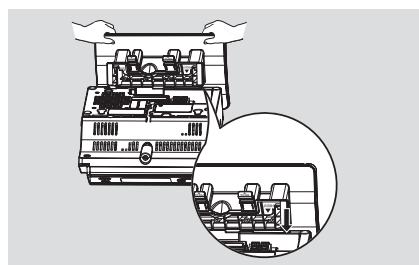

Mounting MCM275 onto walls

See **Appendix: How to mount your MCM275 onto walls** to learn more about wall mounting.

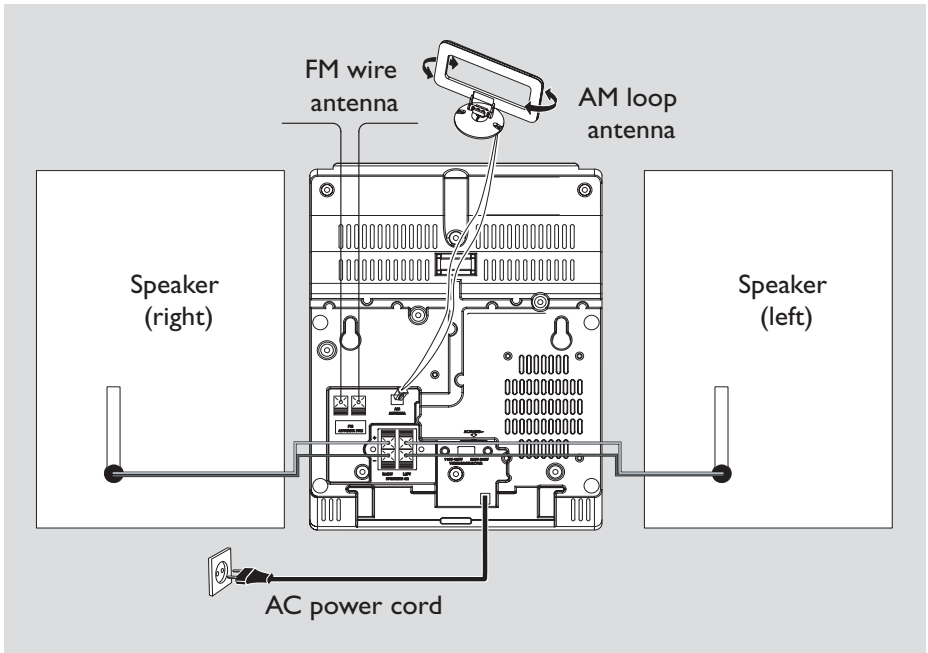

Rear connections

Warning:

- Never make or change connections with the mains supply switched on.
- Install your set near the AC outlet and where the AC power plug can be reached easily.

A Speaker connections

Use the supplied speakers only. Using other speakers can damage the set or the sound quality will be negatively affected.

- Connect the cable of the left speaker to **LEFT** (red and black) and the cable of the right speaker to **RIGHT** (red and black) as follows:
 - a. Press the clip of the red terminal and fully insert the stripped portion of the colored (or marked) speaker cable into the socket, then release the clip
 - b. Press the clip of the black terminal and fully insert the stripped portion of the black (or unmarked) speaker cable into the socket, then release the clip

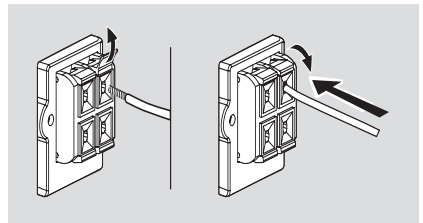

B Antenna connections AM antenna

- 1 Assemble the loop antenna as shown:

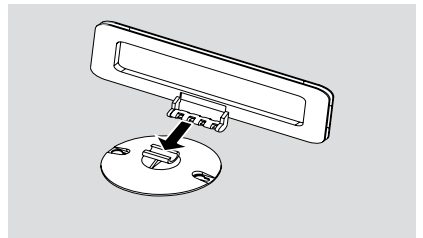

Installation

Or

Insert the loop antenna into the slot on the set

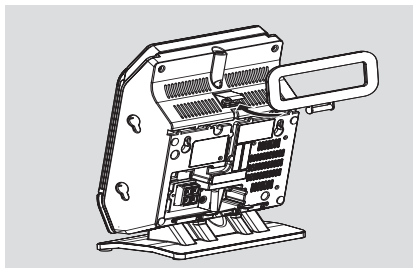

- 2 Fit the plug of the loop antenna to AM ANTENNA as shown below
- 3 Adjust the position of the antenna for optimal reception (as far away as possible from the TV, VCR or other radiation sources)

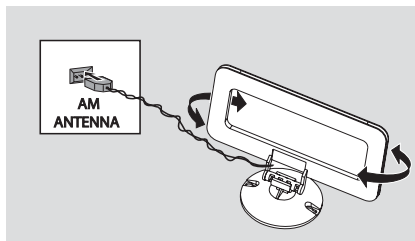

FM antenna

The wire antenna supplied can only be used to receive nearby stations. For better reception we recommend using a cable antenna system or an outdoor antenna.

- 1 Extend the wire antenna and fit it to FM ANTENNA as shown below

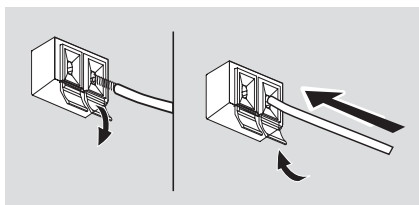

Note: If you are using a cable antenna system or an outdoor antenna, fit the antenna plug, instead of the wire antenna, to FM ANTENNA .

- 2 Move the antenna in different positions for optimal reception (as far away as possible from the TV, VCR or other radiation sources)
- 3 Fix the antenna's end to the wall

Connecting an additional appliance

Connecting a USB device or memory card

By connecting a USB mass storage device (including USB flash memory, USB flash players or memory cards) to the Hi-Fi system, you can enjoy the device's stored music through the powerful speakers of Hi-Fi system.

- 1 Check you have unfolded the control panel

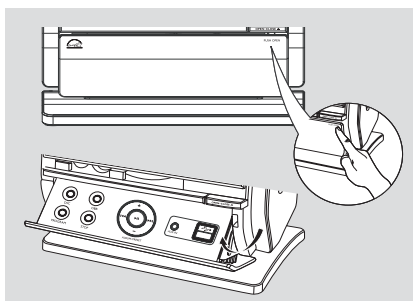

- 2 Insert the USB device's USB plug into the socket  on the set's foldable control panel

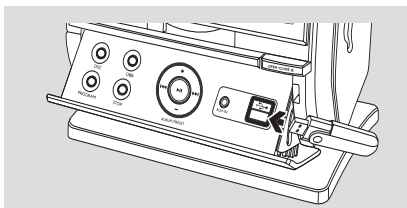

or

for the devices with USB cable:

- a. Insert one plug of the USB cable (not supplied) to the socket  on the set's foldable control panel
- b. Insert the other plug of the USB cable to the USB output terminal of the USB device

or

for the memory card:

- a. Insert the memory card into a card reader (not supplied)
- b. Use a USB cable (not supplied) to connect the card reader to the socket  on the set's foldable control panel

Connecting a non-USB device

It is possible to use an additional appliance, e.g. TV, VCR or CD recorder with the set. On MCM275, you can playback music from an external source.

- 1 Follow the Step 1 under **Connecting a USB device or memory card**
- 2 Insert one plug of the audio cable (not supplied) to the socket **AUX IN** on the set's foldable control panel
- 3 Connect the other end of the audio cable to the **AUDIO OUT** terminal of the additional appliance

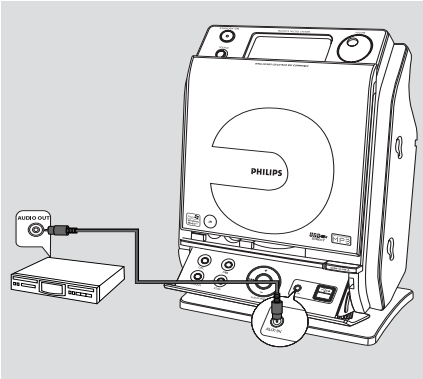

- 4 Select **AUX** mode on the set

Helpful hints:

– Always refer to the owner's manual of other equipment for complete connection.

Using AC power

- 1 Make sure all the connections have been made before switching on the power supply
- 2 Connect the AC power cord to the wall socket. This switches on the power supply

When MCM275 is switched to standby, it is still consuming some power: **To disconnect the system from the power supply completely, remove the power plug from the wall socket.**

The type plate is located on the rear of the set.

Warning!

To avoid overheating of the system, a safety circuit has been built in. Therefore, your system may switch to Standby mode automatically under extreme conditions. If this happens, let the system cool down before reusing it (not available for all versions).

CAUTION

Visible and invisible laser radiation. If the cover is open, do not look at the beam.

High voltage! Do not open. You run the risk of getting an electric shock.

The machine does not contain any user-serviceable parts.

Modification of the product could result in hazardous radiation of EMC or other unsafe operation.

Preparation

Using the remote control

IMPORTANT!

- Remove the protective plastic tab before using the remote control.
- Always point the remote control directly towards IR area.

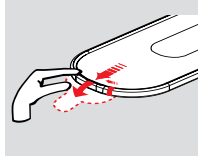

Notes for remote control:

- First select the source you wish to control by pressing one of the source select keys on the remote control (for example CD, TUNER).
- Then select the desired function (for example **▶ II**, **◀ ▶**).

To replace the remote controls' battery

- 1 Press and hold **◀** as indicated.
- 2 Simultaneously, pull the battery tray at **▼**.
- 3 Remove the old battery and put a new CR2025 battery in place.
- 4 Put back the battery tray.

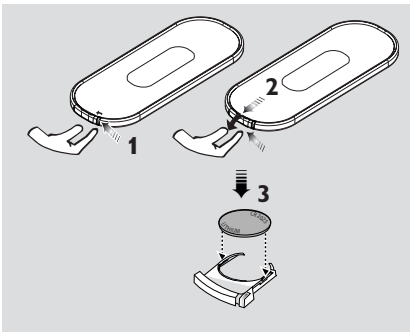

CAUTION!

- Remove the battery if it is exhausted or will not be used for a long time.
- Batteries contain chemical substances, so they should be disposed of properly.

Setting the clock

After connecting MCM275 to the power supply, set the clock first.

- 1 Press and hold **STANDBY-ON** to switch the set to Standby mode
 - The display shows the set time
 - -- --:-- -- flashes by default if you have not set the clock
- 2 In the standby mode, press and hold **DISPLAY/CLOCK** on the remote control
 - **SET CLOCK** scrolls on the display
 - **24 HR** or **12 HR** appears for the initial clock setting. **To select 24-hour clock or 12-hour clock,**
 - On the remote control, press **VOLUME +/-** once or more (or turn **VOLUME** on the set)
 - On the remote control, press **DISPLAY/CLOCK** to confirm
 - The hours digits start flashing
- 3 Hold down or press **VOLUME +/-** repeatedly to set the hours (or turn **VOLUME** on the set)
- 4 Press **DISPLAY/CLOCK** to confirm
 - The minutes digits start flashing
- 5 Hold down or press **VOLUME +/-** repeatedly to set the minutes (or turn **VOLUME** on the set)
- 6 Press **DISPLAY/CLOCK** to confirm
 - To exit without storing the clock setting press **STOP** ■

Helpful hints:

- The clock setting will be erased when the system is disconnected from the power supply.
- The set will exit from the clock setting mode if no button is pressed within 90 seconds.

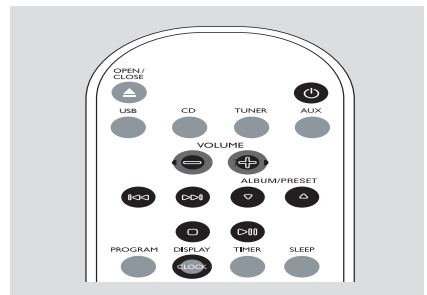

Switching on/off the set and selecting functions

- 1 To switch on, press **STANDBY-ON** or **SOURCE** on the set (or ϕ on the remote control)
 - The set switches to the last source selected
 - OR**
 - On the remote control, press the source button (e.g. **USB, CD, TUNER, AUX**)
- 2 When the set is on, press **STANDBY-ON** to switch off (or ϕ on the remote control)
- 3 To select your function, press **SOURCE** once or more on the set (or **USB, CD, TUNER, AUX** on the remote control)

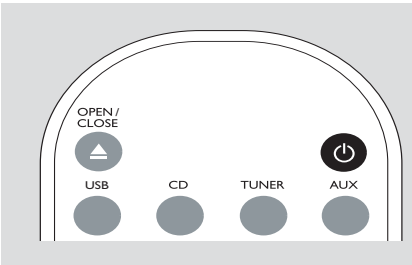

Helpful hints:

- You can also switch on the set by pressing **CD OPEN • CLOSE** \blacktriangle

Switching between Standby and ECO POWER mode

- 1 When the set is switched off, press and hold **STANDBY-ON** to switch between Standby and ECO POWER mode (or ϕ on the remote control)
 - In ECO POWER mode** (power-saving mode):
 - **ECO PWR** scrolls on the display
 - The display is switched off
 - The **Red** indicator lights up
 - In Standby mode:** → The clock is displayed

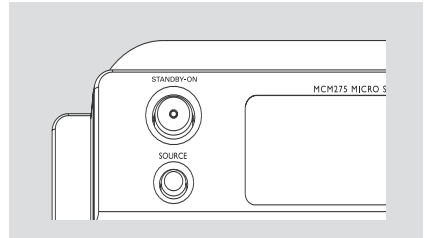

Helpful hints:

- In the standby/Eco power mode, the tone, sound settings, tuner presets and the volume level (up to a maximum volume level of 20) will be retained in the set's memory.

Auto-standby

When the set has reached the end of CD playback and remains in the stop position for more than 15 minutes, the set will switch off automatically to save power.

Basic Functions

Volume control

Volume adjustment

- Adjust the volume by using the **VOLUME** rotary on the set or by pressing **VOLUME +/-** on the remote control
 - **VOL** and the actual value (between 1 and 31) are displayed
 - **VOL MIN** is the minimum volume level
 - **VOL MAX** is the maximum volume level

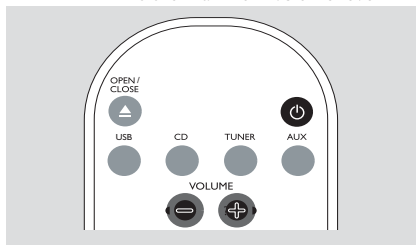

MUTE

You can temporarily switch off the sound without switching off the set.

- Press **MUTE** on the remote control to switch off the sound
 - **MUTE** appears. Playback continues without sound
- To switch on the sound, you can:
 - press **MUTE** again;
 - adjust the volume controls;
 - change source

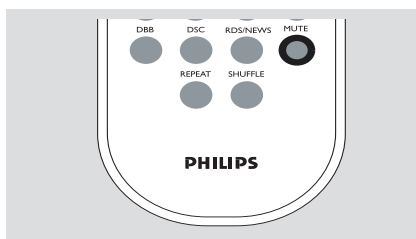

Sound control

DSC

Digital **S**ound **C**ontrol enables you to select predefined sound settings.

- Press **DSC** repeatedly to select the desired sound setting: **ROCK**, **JAZZ**, **POP**, **CLASSIC**

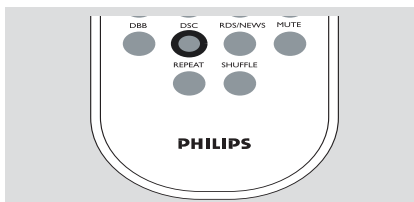

DBB

- Press **DBB** (**D**ynamic **B**ass **B**oost) once or more to switch bass enhancement on or off.
 - **BBB** appears if **DBB** is activated

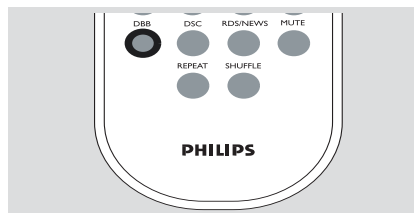

Displaying the clock

- During playback, press **DISPLAY/CLOCK** on the remote control repeatedly to switch between the clock display and the playback display.

Notes:

- When playing **MP3** files, you will get track information (**ID3** tag) by pressing **DISPLAY/CLOCK**.

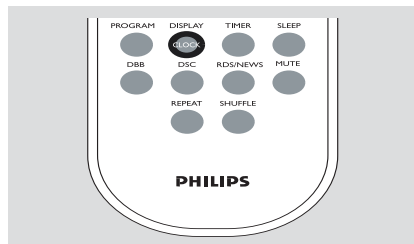

Discs for playback

With this system, you can play

- all pre-recorded audio CDs (CDDA)
- all finalized audio CD-Rs and CD-RWs
- MP3/WMA-CDs (CD-Rs/CD-RWs with MP3/WMA files)



IMPORTANT!

– **This system is designed for regular discs. Therefore, do not use any accessories such as disc stabilizer rings or disc treatment sheets, etc.**

About MP3/WMA

The music compression technology MP3 (MPEG1 Audio Layer 3) and WMA (Windows Media Audio) significantly reduces the digital data of an audio CD while maintaining CD quality sound.

Windows Media Audio® is a registered trademark of Microsoft Corporation.

Supported formats:

- Disc format ISO9660, Joliet, UDF (created on Adaptec Direct CD) and multi-session CDs
- MP3 bit rate (data rate): 32-320 Kbps and variable bit rate
- Directory nesting up to a maximum of 8 levels
- Max. track number plus album: 500
- WMA v9 or earlier



The system will not play or support the following:

- Empty albums: an empty album is an album that does not contain MP3/WMA files, and will not be shown in the display.
- Non-supported file formats are skipped. This means that e.g.: Word documents .doc or MP3 files with extension .dlf are ignored and will not be played.
- DRM protected WMA files
- WMA files in Lossless or VBR format

IMPORTANT!

- Make sure that the file names of MP3 files end with .mp3.
- For DRM protected WMA files, use Windows Media Player 10 (or later) for CD burning/conversion. Visit www.microsoft.com for details about Windows Media Player and WM DRM (Windows Media Digital Rights Management).

Playing discs

- 1 Press **SOURCE** once or more to select **CD** (or **CD** on the remote control)
→ The CD icon  appears
- 2 Press **CD OPEN•CLOSE**  to open the CD compartment.
→ **OPEN** is displayed

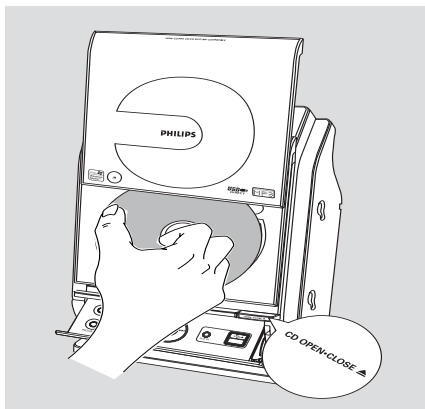

- 3 Insert a disc with the printed side facing up. Press **CD OPEN•CLOSE**  again to close the compartment
→ **READING** is displayed as the CD player scans the contents of a disc
→ **Audio CD**: the total number of tracks and playing time are shown
MP3/WMA: Display shows current album number "R x x" and current track number "T x xx"

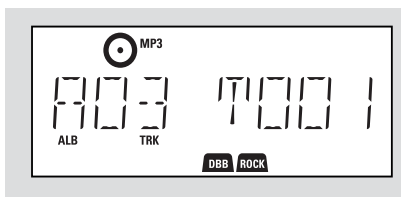

Helpful hints:

– If you have not organized MP3/WMA files into any albums on your disc, an album “00” will be automatically assigned for all those files.

- Press **▶ ||** to start playback
→ Display shows current track number and elapsed playing time

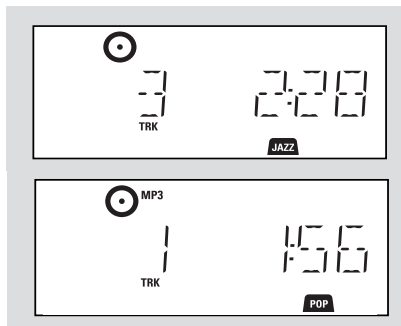

- To pause playback, press **▶ ||**. To resume playback, press the button again
- To stop playback, press **STOP ■**

Helpful hints:

CD play will also stop when

- the CD door is opened
- the disc has reached the end
- you select another source: **TUNER, USB** or **AUX**

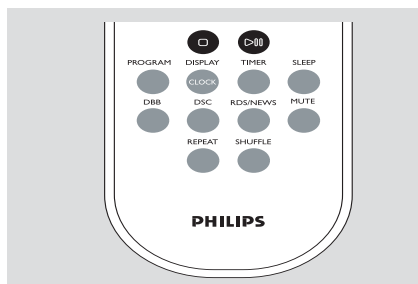

Selecting and searching

Selecting a different track

- Press **◀◀ / ▶▶** once or repeatedly until the desired track number appears in the display
MP3/WMA: → Track information scrolls briefly

MP3/WMA:

- Press **ALBUM/ PRESET** once or more to select the next or previous album
→ Track information scrolls briefly
- or
- In the stop position, press **ALBUM/ PRESET** and **◀◀ / ▶▶** to select the desired album and track
→ **MP3/WMA:** Display shows current album/ track number

Finding a passage within a track during playback

- 1 During playback, press and hold **◀◀ / ▶▶**
→ The CD plays at a high speed
- 2 When you recognize the passage you want, release **◀◀** or **▶▶**
→ Normal playback resumes

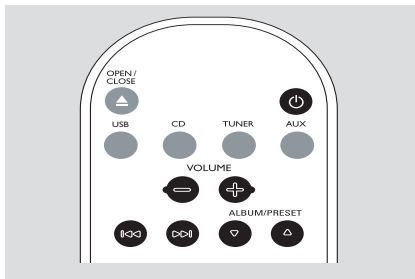

Programming tracks

You may store up to 40 tracks in the desired sequence. If you like, store any track more than once.

- In the stop position, press **PROGRAM** to start programming
 - **P** flashes
 - **Audio CD**: Display shows **PROG** and current track number
 - **MP3/WMA**: Display shows current album/track number

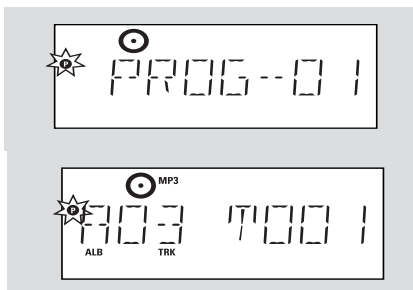

- Press **◀◀ / ▶▶** once or repeatedly until the desired track number appears in the display
 - **MP3/WMA**: press **ALBUM/ PRESET** and **◀◀ / ▶▶** to select the desired album and track
- Press **PROGRAM** to confirm
 - Display shows briefly the number of tracks programmed
 - Then, the display shows the track number you just stored

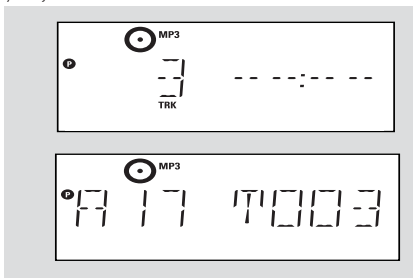

- Repeat steps 2-3 to select and store all desired tracks.
 - **FULL** is displayed if you attempt to program more than 40 tracks
- Press **▶ ||** play the program

Helpful hints:

– The set will return to the stop position if no button is pressed within 90 seconds.

→ **P** disappears. To resume programming, press **PROGRAM**.

– **MP3/WMA**: When playing a program, use of **ALBUM/ PRESET** are void.

Erasing the program

You can erase the contents of the memory by:

- Press **STOP** ■
 - once if in the stop position;
 - twice during playback;
- Press **STANDBY-ON** ⏻
- Select another sound source
- Open the CD door
 - **P** disappears. **CLEAR** scrolls

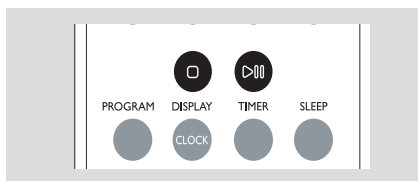

Different play modes: REPEAT, SHUFFLE

REPEAT TRACK – plays the current track continuously

REPEAT ALL – plays the entire disc/program continuously

SHUFFLE – plays all the tracks of the CD in random order

- 1 During playback, press once or more **REPEAT** or **SHUFFLE** to select play modes
- 2 To return to normal playback, press **REPEAT** or **SHUFFLE** repeatedly until the various modes are no longer displayed

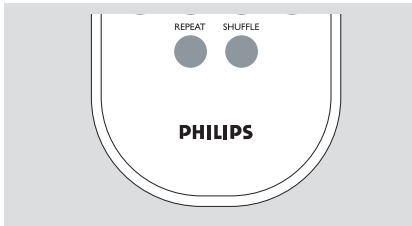

Helpful hints:

- In the shuffle mode, press **▶▶|** to select tracks.

Display track information (MP3/WMA only)

The ID3 tag is part of an MP3/WMA file and contains various track information such as the track's title or the artist's name.

- During playback, press **DISPLAY/CLOCK** repeatedly on the remote control
→ Display show title name, album name and ID3 tag information

Helpful hints:

- Complete the ID3 tag information with your MP3/WMA encoder software before burning the MP3/WMA-CD.

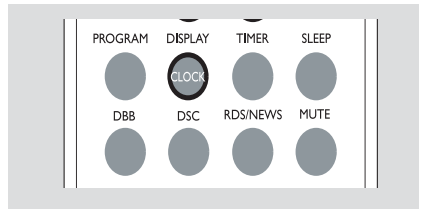

Tuning to radio stations

- 1 Press **SOURCE** once or more to select **TUNER** (or **TUNER** on the remote control)
- 2 Press **TUNER** on the remote control repeatedly to select your desired waveband, FM or AM
→ Display shows: , radio station frequency, waveband and if programmed, a preset number

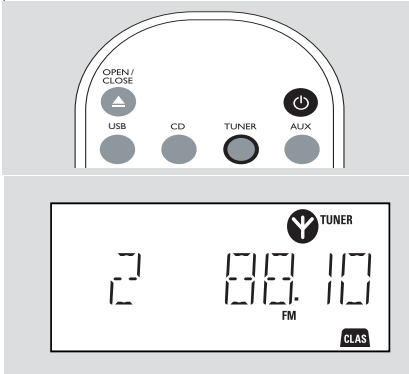

- 3 Press and hold **◀◀ / ▶▶** until **SEARCH** appears
→ The radio automatically tunes to a station with sufficient reception. Display shows **SEARCH** during automatic tuning
→ **FM**: If a station is received in stereo,  is shown
- 4 Repeat step 3 if necessary until you find the desired station.
- To tune to a weak station, press **◀◀ / ▶▶** briefly and repeatedly until you have found optimal reception.

Programming radio stations

You can store up to a total of 40 radio stations (FM and AM) in the memory, manually or automatically (Autostore).

Autostore: Automatic programming

Automatic programming will start from preset 1 or a chosen preset number. From this preset number upwards, former programmed tuner stations will be erased. The set will only program stations which are not in the memory already.

- 1 Press the **ALBUM/ PRESET** buttons once or more to select the preset number where programming should start.

Note:

– If no tuner preset number is selected, default is preset 1 and all your presets will be erased.

- 2 Press and hold **PROGRAM** until **AUTO** appears
→ **P** flashes
→ Available stations are programmed: FM stations followed by AM stations
→ After all stations are stored, the last preset station will then be played

Manual programming

- 1 Tune to your desired station (see **Tuning to radio stations**)
- 2 Press **PROGRAM** to activate programming
→ **P** flashes
- 3 Press **ALBUM/ PRESET** to allocate a number from 1 to 40 to this station.
- 4 Press **PROGRAM** to confirm
→ Display shows the preset number, waveband and the frequency of the preset station
- 5 Repeat steps 1-4 to store other stations
- You can erase a preset station by storing another frequency in its place

To listen to a preset station

- 1 Press the **ALBUM/ PRESET** buttons once or more until the desired preset station is displayed.

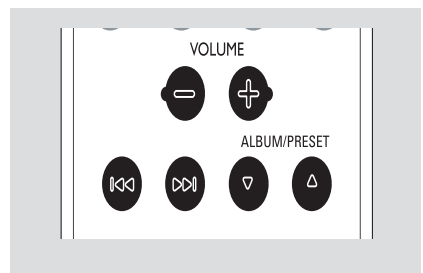

Using a USB mass storage device

By connecting a USB mass storage device to the Hi-Fi system, you can enjoy the device's stored music through the powerful speakers of Hi-Fi system.

Playing a USB mass storage device

Compatible USB mass storage devices

With the Hi-Fi system, you can use

- USB flash memory (USB 2.0 or USB1.1)
- USB flash players (USB 2.0 or USB1.1)
- memory cards (requires an additional card reader to work with this Hi-Fi system)

Note:

– In some USB flash players (or memory devices), the stored contents are recorded using copyright protection technology. Such protected contents will be unplayable on any other devices (such as this Hi-Fi system).

Supported formats:

- USB or memory file format FAT12, FAT16, FAT32 (sector size: 512 - 65,536 bytes)
- MP3 bit rate (data rate): 32-320 Kbps and variable bit rate
- WMA v9 or earlier
- Directory nesting up to a maximum of 8 levels
- Number of albums/ folders: maximum 99
- Number of tracks/titles: maximum 999
- ID3 tag v2.0 or later
- File name in Unicode UTF8 (maximum length: 128 bytes)

The system will not play or support the following:

- Empty albums: an empty album is an album that does not contain MP3/WMA files, and will not be shown in the display.
- Non-supported file formats are skipped. This means that e.g.: Word documents .doc or MP3 files with extension .dlf are ignored and will not be played.
- AAC, WAV, PCM audio files
- DRM protected WMA files
- WMA files in Lossless format

How to transfer music files from PC to a USB mass storage device

By dragging and dropping music files, you can easily transfer your favorite music from PC to a USB mass storage device.

For the flash player, you can also use its music management software for the music transfer:

However, those WMA files may be unplayable for compatibility reasons.

How to organize your MP3/WMA files on the USB mass storage device

This Hi-Fi system will browse the MP3/WMA files in the folders/sub-folders/titles order.

Example:

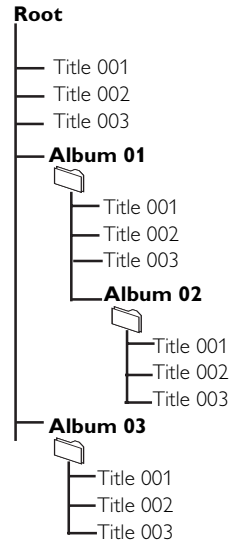

Organize your MP3/WMA files in different folders or subfolders as required.

Note:

- If you have not organized MP3/WMA files into any albums on your disc, an album "00" will be automatically assigned for all those files.
- Make sure that the file names of MP3 files end with .mp3. and the file names of WMA files end with .wma.
- For DRM protected WMA files, use Windows Media Player 10 (or later) for conversion. Visit www.microsoft.com for details about Windows Media Player and WM DRM (Windows Media Digital Rights Management).

- 1 Check the USB device has been properly connected. (See **Installation: Connecting an additional appliance**)
- 2 Press **SOURCE** once or more to select **USB** (or **USB** on the remote control)
 - The icon  appears

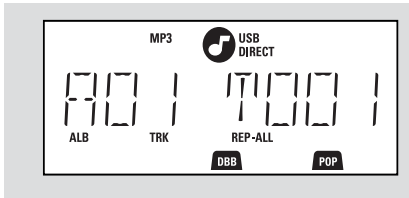

- **NO AUDIO** appears if no audio file is found in the USB device
- 3 Play the USB's audio files as you do with the albums/tracks on a CD (See **CD**)

Note:

- For compatibility reasons, the album/track information may differ from what it is displayed through flash players' music management software.
- File names or ID3 tags will be displayed as ---- if they are not in English.

AUX (Listening to an external source)

You can listen to the sound of the connected external device through your MCM275

- 1 Check the external device has been properly connected (See **Installation, Connecting an additional appliance**)
- 2 Press **SOURCE** once or more to select **AUX** (or **AUX** on the remote control)
- 3 To avoid noise distortion, turn down the volume on your external device
- 4 Press the **PLAY** key on the connected device to start playback
- 5 To adjust the sound and volume, use the sound controls on your external device and the MCM275

Setting the timer

The set can be used as an alarm clock, whereby the selected source (CD, TUNER or USB) starts playback at a preset time. **Make sure the clock is set before using the timer.**

- 1 Press and hold **TIMER** on the remote control until **SET TIMER** appears
 -  flashes. **SELECT SOURCE** scrolls
 - Display shows current source **CD, TUNER** or **USB**
- 2 Press **SOURCE** on the set repeatedly to select the source (or press **CD, TUNER** or **USB** on the remote control)
- 3 Press **TIMER** to confirm
 - The hours digits start flashing

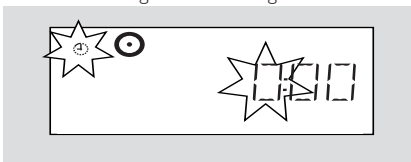

- 4 Hold down or press **VOLUME +/-** repeatedly to set the hours (or turn **VOLUME** on the set)
- 5 Press **TIMER** to confirm
 - The minutes digits start flashing
- 6 Hold down or press **VOLUME +/-** repeatedly to set the minutes (or turn **VOLUME** on the set)
- 7 Press **TIMER** to confirm
 - The timer is now set and activated
 - At the set alarm time, the CD, TUNER or USB will switch on (volume level: max. 20)

Note:

– The set will exit from the timer setting mode if no button is pressed within 90 seconds.

Activating and deactivating TIMER

- Press **TIMER** on the remote repeatedly to activate or deactivate the timer:
 - If activated, the last set source and start time are displayed
 - If deactivated, "TIMER OFF" appears

Helpful hints:

The timer will not work at the set time if

- the set is switched on
- the timer is deactivated

The set will switch to Tuner source automatically if:

- no CD is inserted when the selected source is CD;
- no USB device is connected when the selected source is USB

SLEEP

You can set a certain period of time after which the set will switch off.

- On the remote control, press **SLEEP** repeatedly to select the desired time period options (in minutes):
 - Display shows in sequence: **Sleep 90, 75, 60, 45, 30, 15**
 - Display shows the selected option briefly and returns to its previous status. The icon **zzZ** appears

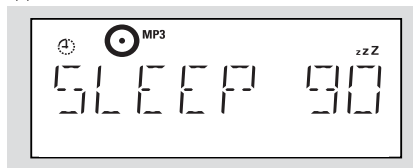

To deactivate the sleep timer, press **SLEEP** again

→ The icon **zzZ** disappears

or

Press **STANDBY-ON** to switch off the set (or  on the remote control)

Helpful hints:

– The SLEEP function does not affect your alarm time setting.

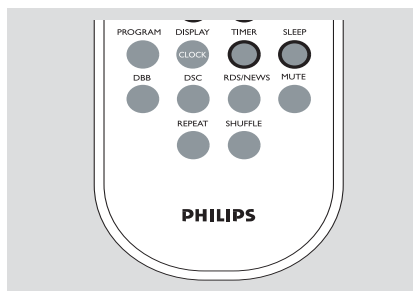

AMPLIFIER

Output power 2 x 5 W RMS
 10 W + 10 W MPO
 2 x 4 W FTC⁽¹⁾
 Signal-to-noise ratio ≥ 75 dBA
 Frequency response 50 – 20,000 Hz, ± 3 dB
 Input sensitivity AUX 0.5 V (max. 2 V)
 Impedance loudspeakers $\geq 4 \Omega$
 Impedance headphones 32 Ω -1000 Ω
 <0.5W
 (1) (4 W, 120-12.5 kHz, 10% THD)

CD PLAYER

Frequency range 30 – 18000 Hz
 Signal-to-noise ratio 75 dBA

TUNER

FM wave range 87.5 – 108 MHz
 AM wave range 530 - 1700 kHz
 Number of presets 40
 Antenna
 FM 300 Ω wire
 AM Loop antenna

USB PLAYER

USB 12Mb/s, V1.1
 support MP3 and WMA files
 Number of albums/ folders maximum 99
 Number of tracks/titles maximum 999

SPEAKERS

Bass reflex system
 Dimensions (w x h x d) ... 160 x 270 x 90 (mm)

GENERAL INFORMATION

AC Power 120V / 60 Hz
 Dimensions (w x h x d, with/without the stand)
 194 x 285 x 118/194 x 270 x 92 (mm)
 Weight(with/without speakers) 3.8 / 2.2 kg
 Standby power consumption <5 W
 Eco power standby <0.5 W

Specifications and external appearance are subject to change without notice.

Maintenance

Cleaning the Cabinet

- Use a soft cloth slightly moistened with a mild detergent solution. Do not use a solution containing alcohol, spirits, ammonia or abrasives.

Cleaning Discs

- When a disc becomes dirty, clean it with a cleaning cloth. Wipe the disc from the centre out.
- Do not use solvents such as benzene, thinner, commercially available cleaners, or antistatic spray intended for analogue records.

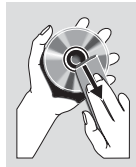

Cleaning the disc lens

- After prolonged use, dirt or dust may accumulate at the disc lens. To ensure good playback quality, clean the disc lens with Philips CD Lens Cleaner or any commercially available cleaner. Follow the instructions supplied with cleaner.

Troubleshooting

WARNING

Under no circumstances should you try to repair the system yourself, as this will invalidate the warranty. Do not open the system as there is a risk of electric shock.

If a fault occurs, first check the points listed below before taking the system for repair. If you are unable to remedy a problem by following these hints, consult your dealer or Philips for help.

| Problem | Solution |
|--|--|
| "NO DISC" is displayed. | <ul style="list-style-type: none">✓ Insert a disc.✓ Wait until the moisture condensation at the lens has cleared.✓ Replace or clean the disc, see "Maintenance".✓ Use a finalised CD-RW or a correct MP3/WMA-CD format disc. |
| Some files on the USB device are not displayed. | <ul style="list-style-type: none">✓ Check if the number of folders exceeds 99 or the number of titles exceeds 999 |
| Radio reception is poor. | <ul style="list-style-type: none">✓ If the signal is too weak, adjust the antenna or connect an external antenna for better reception.✓ Increase the distance between the Micro HiFi System and your TV or VCR. |
| The system does not react when buttons are pressed. | <ul style="list-style-type: none">✓ Remove and reconnect the AC power plug and switch on the system again. |
| Sound cannot be heard or is of poor quality. | <ul style="list-style-type: none">✓ Adjust the volume.✓ Disconnect the headphones.✓ Check that the speakers are connected correctly.✓ Check if the stripped speaker wire is clamped.✓ Make sure the MP3-CD was recorded within 32~256 kbps bit rate with sampling frequencies at 48 kHz, 44.1 kHz or 32 kHz. |
| The left and right sound outputs are reversed. | <ul style="list-style-type: none">✓ Check the speaker connections and location. |

The remote control does not function properly.

- ✓ Select the source (CD or TUNER, for example) before pressing the function button (▶||, ◀, ▶|).
- ✓ Reduce the distance between the remote control and the system.
- ✓ Insert the battery with its polarities (+/- signs) aligned as indicated.
- ✓ Replace the battery.
- ✓ Point the remote control directly toward IR sensor on the front of the system.

The timer is not working.

- ✓ Check the set is switched off
- ✓ Set the clock correctly.
- ✓ Press TIMER to switch on the timer:

The Clock/Timer setting is erased.

- ✓ Power has been interrupted or the power cord has been disconnected. Reset the clock/timer:

How to mount your MCM275 onto walls

IMPORTANT!

- The wall mounting instructions are for the use of the qualified wall mounting person only!
- Ask a qualified person to help you with the wall mounting, which includes drilling holes on the wall and mounting the set onto walls.

What's in the supplied mounting kits

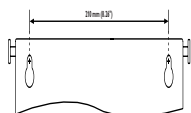

1 x template



2 x screws

What else you'll need

- Drilling tools (e.g. electric drill)

Preparation

- 1 To find a suitable location for mounting, try your necessary rear connections (see the chapter **Installation**).
- 2 Ask a qualified person to help you with the wall mounting, who should:
 - to avoid unexpected damage, learn about the piping, wiring and other relevant information inside your walls;
 - according to the drilling requirements, choose suitable drilling tools;
 - take other precautions necessary for the wall mounting work.

Mounting your MCM275

- 1 Align the template in the chosen location on a wall. Use a pencil to mark the drilling positions (as shown)

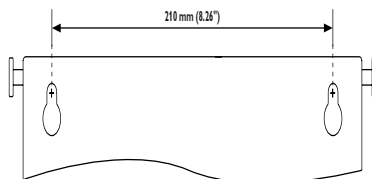

- 2 Drill two 6mm diameter holes as marked
- 3 Secure the dowels and screws in the holes respectively, leaving the screws 5mm proud of the wall

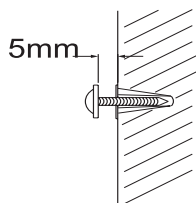

- 4 To detach the stand,
 - a. As shown, hold down the **▲ PRESS** buttons
 - b. Move out the stand to detach

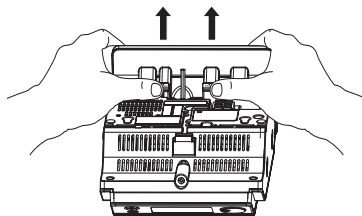

- 5 Hang the unit on the fastening screws
- 6 As shown, hook and mount the speakers in place

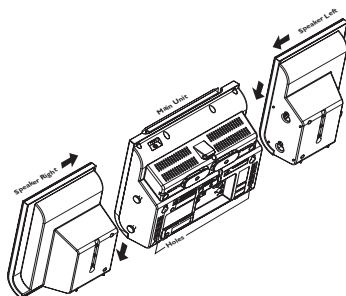

PHILIPS LIMITED WARRANTY

One (1) Year Labor and Parts Repair (Facility)

PHILIPS CONSUMER ELECTRONICS warrants this product against defect in material or workmanship, subject to any conditions set forth as follows:

PROOF OF PURCHASE:

You must have proof of the date of purchase to receive warranted repair on the product. A sales receipt or other document showing the product and the date that you purchased the product as well as the authorized retailer included, is considered such proof.

COVERAGE:

(If this product is determined to be defective)

LABOR: For a period of one (1) year from the date of purchase, Philips will repair or replace the product, at its option, at no charge, or pay the labor charges to the Philips authorized repair facility (see warranty service phone numbers in next column). After the period of one (1) year, Philips will no longer be responsible for charges incurred.

PARTS: For a period of one (1) year from the date of purchase, Philips will supply, at no charge, new or rebuilt replacement parts in exchange for defective parts. Philips authorized repair facility will provide removal and installation of the part under the specified labor warranty.

EXCLUDED FROM WARRANTY COVERAGE

Your warranty does not cover:

- Labor charges for installation or setup of the product, adjustment of customer controls on the product, and installation or repair of antenna systems outside of the product.
- Product repair and/or part replacement because of improper installation, connections to improper voltage supply, abuse, neglect, misuse, accident, unauthorized repair or other cause not within the control of Philips.
- A product that requires modification or adaptation to enable it to operate in any country other than the country for which it was designed, manufactured, approved and/or authorized, or repair of products damaged by these modifications.
- Damage occurring to product during shipping when improperly packaged or cost associated with packaging.
- Product lost in shipment and no signature verification of receipt can be provided.
- A product used for commercial or institutional purposes (including but not limited to rental purposes).
- Products sold AS IS or RENEWED.

SHIP-IN WARRANTY

For Ship-In warranty repair, ship the product to a Philips authorized service facility for repair in its original carton and packing material. If you do not have the original carton or packing material, have your product professionally packed for shipping. Ship product via a traceable carrier. When it is necessary for you to ship the product to Philips for repair, you will pay the shipping cost for shipment to Philips. Philips will pay the shipping costs when returning the product to you.

TO OBTAIN WARRANTY SERVICE IN THE U.S.A., PUERTO RICO, OR U.S. VIRGIN ISLANDS...

Contact Philips Customer Care Center at:

1-888-PHILIPS (1-888-744-5477)

TO OBTAIN WARRANTY SERVICE IN CANADA...

1-800-661-6162 (French Speaking)

1-888-PHILIPS (1-888-744-5477) (English or Spanish Speaking)

REPAIR OR REPLACEMENT AS PROVIDED UNDER THIS WARRANTY IS THE EXCLUSIVE REMEDY FOR THE CONSUMER. PHILIPS SHALL NOT BE LIABLE FOR ANY INCIDENTAL OR CONSEQUENTIAL DAMAGES FOR BREACH OF ANY EXPRESS OR IMPLIED WARRANTY ON THIS PRODUCT. EXCEPT TO THE EXTENT PROHIBITED BY APPLICABLE LAW, ANY IMPLIED WARRANTY OF MERCHANTABILITY OR FITNESS FOR A PARTICULAR PURPOSE ON THIS PRODUCT IS LIMITED IN DURATION TO THE DURATION OF THIS WARRANTY.

Some states do not allow the exclusions or limitation of incidental or consequential damages, or allow limitations on how long an implied warranty lasts, so the above limitations or exclusions may not apply to you. In addition, if you enter into a service contract agreement with the PHILIPS partnership within ninety (90) days of the date of sale, the limitation on how long an implied warranty lasts does not apply.

This warranty gives you specific legal rights. You may have other rights which vary from state/province to state/province.

Philips, P.O. Box 671539, Marietta, GA. 30006-0026

(Warranty: 4835 710 27100)