

HVR-04E

Installation Guide

v 1.0

FCC Compliance Statement

Caution: Any changes or modifications in construction of this device which are not expressly approved the party responsible for compliance could void the user's authority to operate the equipment.

NOTE: This equipment has been tested and found to comply with the limits for a Class B digital device, pursuant to part 15 of the FCC Rules. These limits are designed to provide reasonable protection against harmful interference in a residential installation. This equipment generates uses and can radiate radio frequency energy and, if not installed and used in accordance with the instructions, may cause harmful interference to radio communications, However, there is no guarantee that interference will not occur in a particular installation. If this equipment does cause harmful interference to radio or television reception, which can be determined by turning the equipment off and on, the user is encouraged to try to correct the interference by one or more of the following measures:

- Reorient or relocate the receiving antenna.
- Increase the separation between the equipment and receiver.
- Connect the equipment into an outlet on a circuit different from that to which the receiver is connected.
- Consult the dealer or an experienced radio/TV technician for help.

CAUTION

1. Danger of explosion if battery is incorrectly replaced. Replace only with the same or equivalent type.
2. Disposal of used batteries according to the general recommendations against the environmental pollution.
3. Do not throw the batteries into a fire, and do not heat, short-circuit or attempt to disassemble the batteries.
4. Do not attempt to recharge the batteries.

Important Notice

1. Do not place heavy objects on the top of the HVR-04E.
2. HVR-04E is for indoor use. It is not weatherproof. Use HVR-04E with referring to its environmental specifications (Temperature & Humidity). To clean the HVR-04E, gently wipe the outside with a clean dry cloth.
3. Be sure to use a DC adapter that is provided by Hunt Electronic USA, Inc. Connecting HVR-04E directly to an AC current will cause electric damages to HVR-04E.
4. Be careful not to drop the HVR-04E. Physical shocks may harm the product. In addition, be sure the HVR-04E is secured after installation.
5. If HVR-04E does not operate properly, please contact the closest HUNT ELECTRONIC USA, INC. distributor for after sales service. Tampering or disassembling the product will void the warranty.
6. Security surveillance laws may differ for each country. Therefore, please contact the local region first to avoid any surveillance law violations.

OVERVIEW	7
1. What is HVR-04E?.....	7
2. Supplied Accessories.....	8
3. Description & Function	9
INSTALLATION AND CONNECTION.....	11
4. Connecting & Running HVR-04E.....	11
4.1. Connecting camera	11
4.2. Connecting Monitor	12
4.3. Connecting Audio	12
4.4. Supplying Power.....	14
5. Running OSD menu.....	15
5.1. Using menu	15
5.2. Dialogue Box to Edit a Word.....	16
6. Setting remote controller	17
6.1. Setting remote control DIP switch.....	17
6.2. Set ID of HVR-04E	17
6.3. Selecting HVR-04E.....	18
6.4. Operable range of remote controller	19
6.5. Loading the batteries into remote controller	19
7. HVR-04E Configuration	20
7.1. Basic Configuration	20
7.2. Advanced Configuration	20
7.3. External Storage & Backup Configuration.....	21
7.4. Internet/Intranet Configuration	21
8. HVR-04E Basic Setting	22
8.1. Viewing Image	22
8.2. Setting Date & Time.....	23
8.2.1. Time Zone	23

8.2.2.	Daylight Saving	23
8.2.3.	Time Format	24
8.2.4.	Date.....	24
8.2.5.	Time	24
8.2.6.	Apply Date/Time	24
8.3.	Setting Recording Condition	25
8.3.1.	Configuration Status	26
8.3.2.	Channel Status	26
8.3.3.	Recording Speed/Quality	26
8.3.4.	Speed(ips)	26
8.3.5.	Quality	27
8.3.6.	Audio Recording	27
8.3.7.	Apply	27
9.	Connecting and Configuring Sensor	28
9.1.	Connecting Sensor Input	28
9.2.	Setting Sensor at OSD menu	29
10.	Connecting & Configuring Relay Out	30
10.1.	Connecting Relay Out.....	30
10.2.	Configuring Relay Out.....	31
11.	Connecting External Device with Serial Port	32
11.1.	Connecting Text Input Device (ATM / POS / Access Control).....	32
12.	Connecting & Configuring Serial Ports for Pan/Tilt/Zoom	33
12.1.	Connecting Serial Port	33
12.1.1.	Connecting RS232.....	33
12.1.2.	Connecting RS485.....	33
12.1.3.	Connecting RS422.....	33
12.2.	Configuring Serial Port.....	34
13.	Connecting USB Device	35
14.	Connecting External Storage	37
14.1.	IEEE1394 Bay.....	37
14.2.	Connecting IEEE1394 Device	37

14.3.	Available HDD.....	37
14.4.	Registering & Formatting HDD.....	38
15.	Network Monitoring & Managing	39
15.1.	Connecting Ethernet	39
15.2.	Configuring HVR-04E's Network Information	40
16.	Using DVR Manager.....	41
16.1.	PC System Requirements for running DVR Manager	41
16.1.1.	Installing DVR Manager	41
16.1.2.	Uninstalling DVR Manager.....	43
16.2.	Configstation.....	43
16.3.	Monitor.....	44
16.4.	Playback	44
APPENDIX	45
Appendix #1	Installing and Replacing internal HDD	46
Appendix #2	Video Input	51
Appendix #3	Using CD-ROM	52
Appendix #4	Specification	53

OVERVIEW

1. What is HVR-04E?

The HVR-04E is a 4-Analog, 12-IP channel network digital video recorder. The HVR-04E can record and display 4 analog video channels and 12 IP video channels simultaneously. Video, Audio, and Text Event-Logs are digitized and stored on two internal hard-drives.

Key features

- Expandable up to 16 channels (4 analog video channels + 12 IP video channels)
- 1 channel audio recording & playback
- Total 120 ips recording speed (Analogue video 60ips + IP video 60ips)
- Total 120 ips display speed (Max 60ips over Network)
- Built-in software multiplexer for all 16 live monitoring channels (1 / 4 / 9 / 13 / 16Ch Mode on CCTV Monitor as well as PC)
- Maximum 4TB storage capacity (IEEE 1394 for external HDD)
- ATM/POS transaction information text recording and search with corresponding video
- 4 pairs of sensor inputs and alarm outputs
- Built-in hardware motion detection with search function (64-division comparison)
- Various efficient back-up methods (IEEE 1394(FiWi), USB (V 1.1), Ethernet)
- PTZ Control (Preset support) via RS 232 and RS 485/RS422
- User-friendly 32bit True-colored Graphic OSD Menu
- Dynamic IP (DHCP, Floating IP) support (when xDSL and Cable Modem are used)
- IR remote controller (User controls PTZ with remote controller)
- Remote Management Software (DVR Manager)

2. Supplied Accessories

Unpack and check all the items as below.

1. HVR-04E (1)

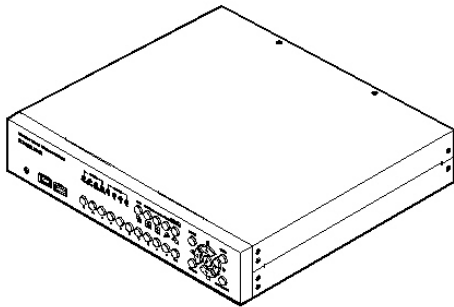

2. DC Power Supply (1)
(110V~220V)

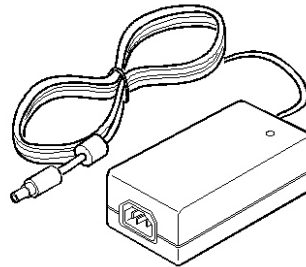

3. AC Power Cord (1)

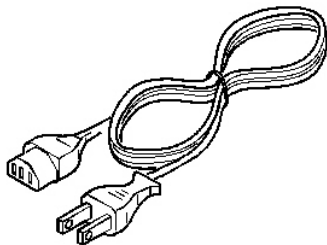

4. CD-ROM (Including DVR Manager) (1)

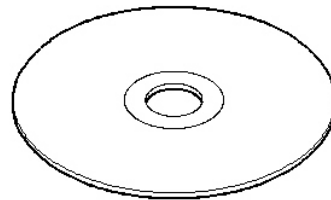

5. Remote Controller (1)

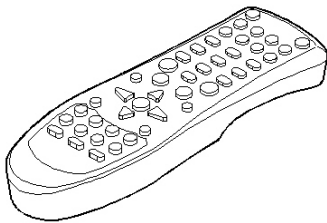

6. Guide (2)

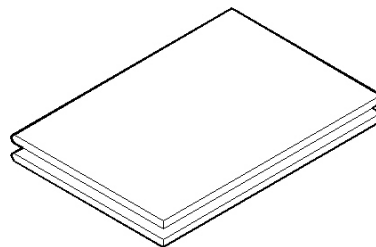

7. Plug Bracket (1)

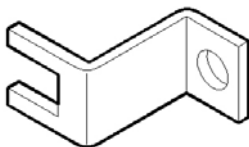

8. HDD Fixing Screw (8)

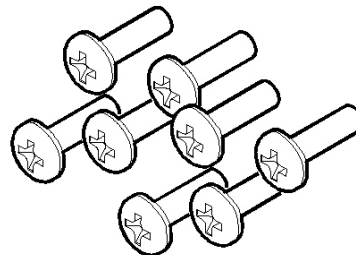

3. Description & Function

HVR-04E Front

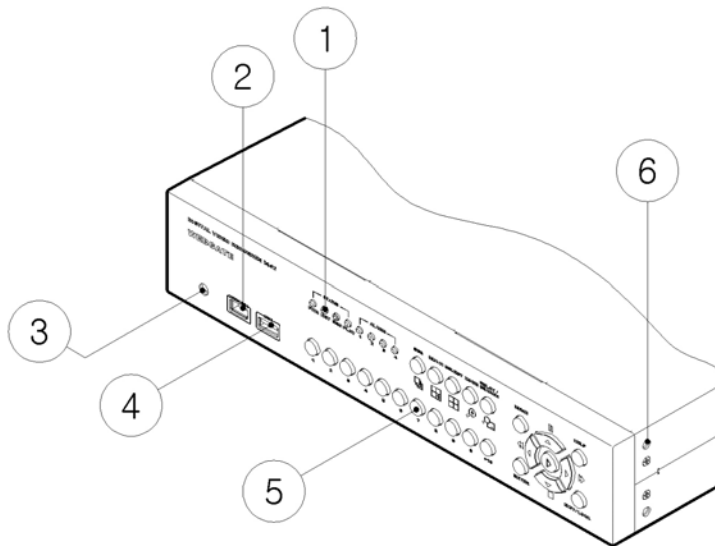

- (1) LED
- (2) IEEE1394 connector
- (3) Remote controller receiver
- (4) USB connector
- (5) Function buttons
- (6) Bracket fixing hole for rack mount

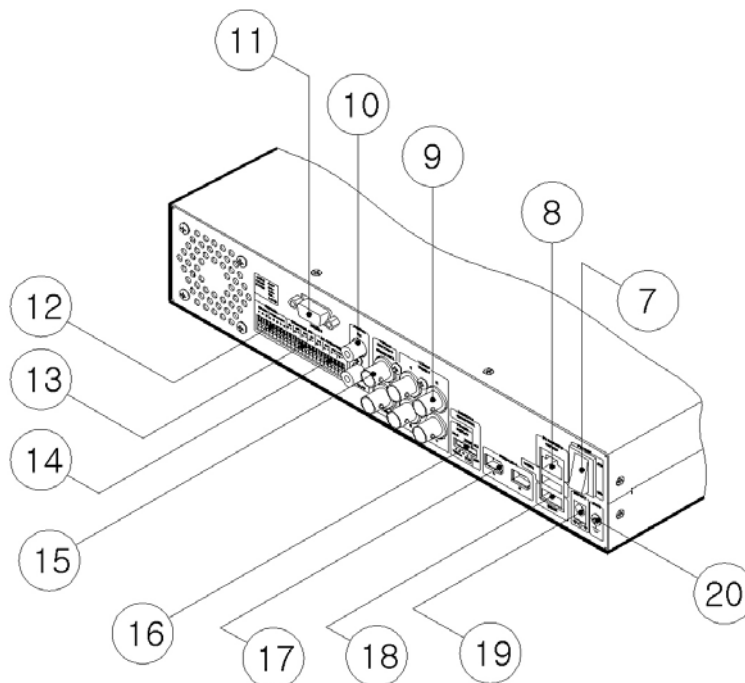
HVR-04E Rear

- (7) Power switch
- (8) Ethernet connector
- (9) BNC connector for Video input
- (10) Audio input / output connector
- (11) RS232 connector (9Pin D-Sub)
- (12) Terminal block for RS232 & 422/485
- (13) Terminal block for Sensor input
- (14) Terminal block for Relay output
- (15) Video output for MONITOR or VCR
- (16) Video input type/impedance select & remote controller switch
- (17) IEEE1394 connector
- (18) USB connector
- (19) Power connector (DC12V)
- (20) GND

INSTALLATION AND CONNECTION

4. Connecting & Running HVR-04E

4.1. Connecting camera

- (1) Connect CCTV camera to HVR-04E with BNC cable as shown below.
- (2) Set video type (NTSC/PAL) by rear panel's switch.

<Note>
 The video type for all channels should be either NTSC or PAL. NTSC is the standard used in North America.

- (3) Set the impedance control switch for each channel as needed.

<Note>
 It may be necessary to configure impedance of video input differently for each channel. For more detailed information, please refer to "Video type / impedance setup switch" in Appendix #2.

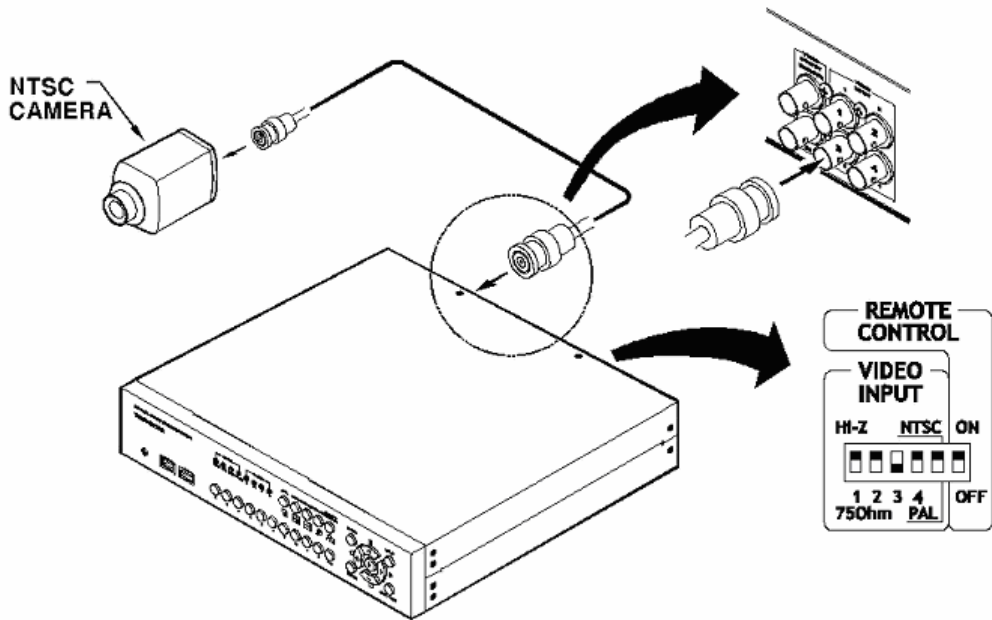

4.2. Connecting Monitor

- (1) Connect CCTV monitor to HVR-04E with BNC cable as shown below.

<Note>

HVR-04E has two video output ports ; for Monitor and VCR. The output signals from the two ports are same and either port may be used.

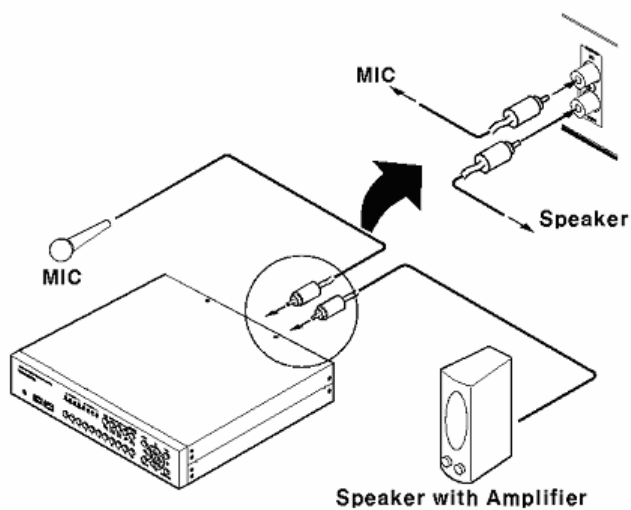

4.3. Connecting Audio

- (1) Connect audio signal to HVR-04E.

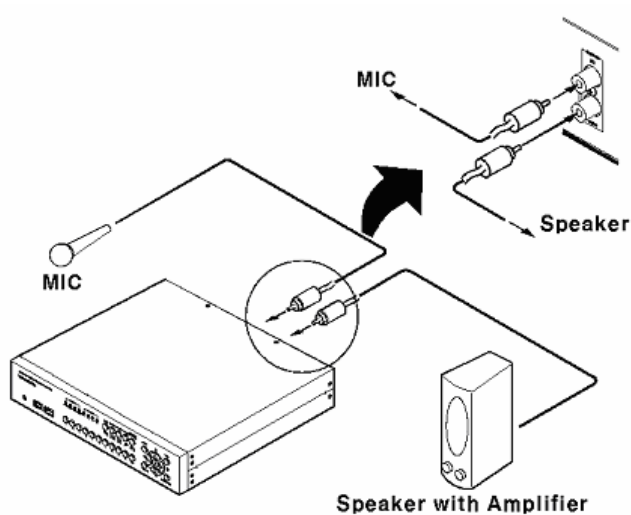

4.4. Supplying Power

- (1) Connect power cable to HVR-04E.
- (2) Turn on the power switch located on the HVR-04E rear panel.

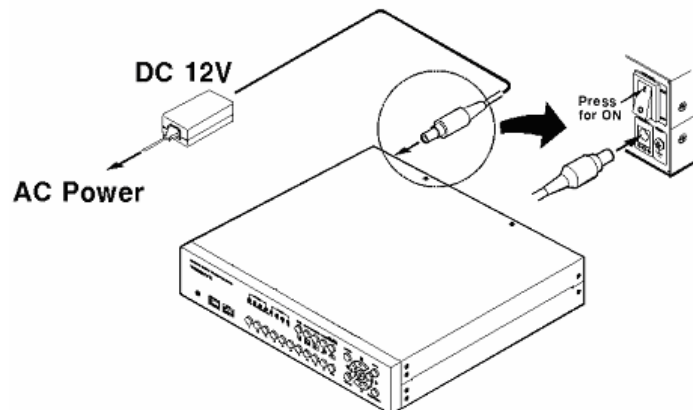

<Note>

Use the plug bracket to secure the power cable if needed.

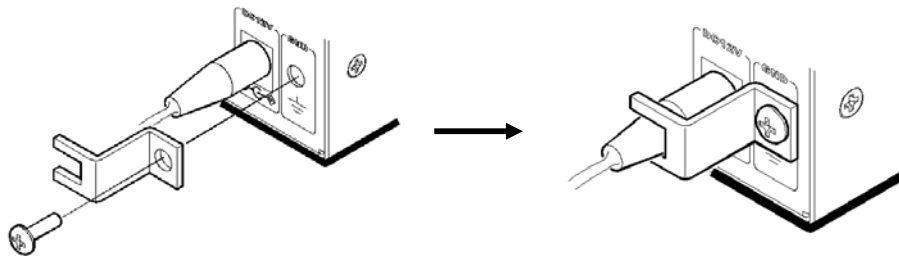

<Note>

To connect EARTH, refer to the following picture.

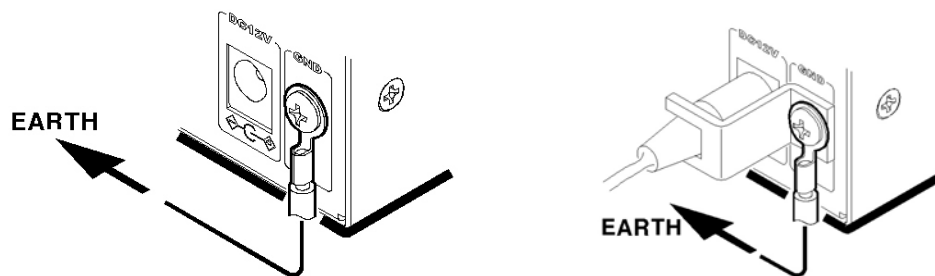

5. Running OSD menu

5.1. Using menu

Press the [MENU] button to open the OSD Configuration Menu.

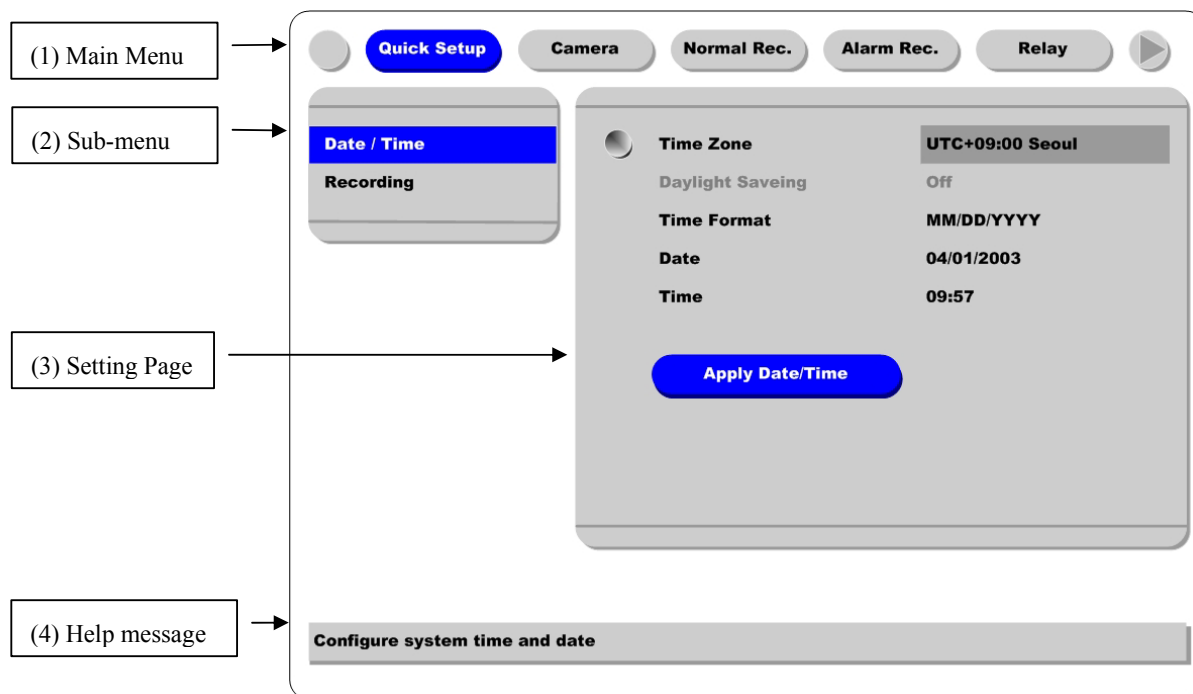

(1) Main Menu Tabs: The selected tab is shown in blue and the related sub-menus will be shown below the tab. To move to the previous/next Main Menu Tab, use the [◀◀ / ▶▶] arrow buttons. To move to a sub-menu, press the [ENTER] or [▼] buttons.

(2) Sub-menu: The selected sub-menu is shown in blue and the related setting page will be shown to the right of the sub-menu. Use the [▲/▼] arrow buttons to move within the sub-menu list. To move to the setting page press the [ENTER] button. To exit the setting page, press the [EXIT] button.

(3) Setting Page: The selected item is shown in gray. To move within each page, use the [◀◀ / ▶▶] or [▲/▼] arrow buttons. Press the [ENTER] button to change the value of a setting. When the setting value is a word, a dialogue box to edit the word will open. When setting value is a number, it should be set with using the [◀◀ / ▶▶] or [▲/▼] arrow buttons. After the value is set, press the [EXIT] button. To exit the Setting Page, press the [EXIT] button.

(4) Help message: Related information for each menu/setting will be displayed here.

5.2. Dialogue Box to Edit a Word

There are two methods to set word.

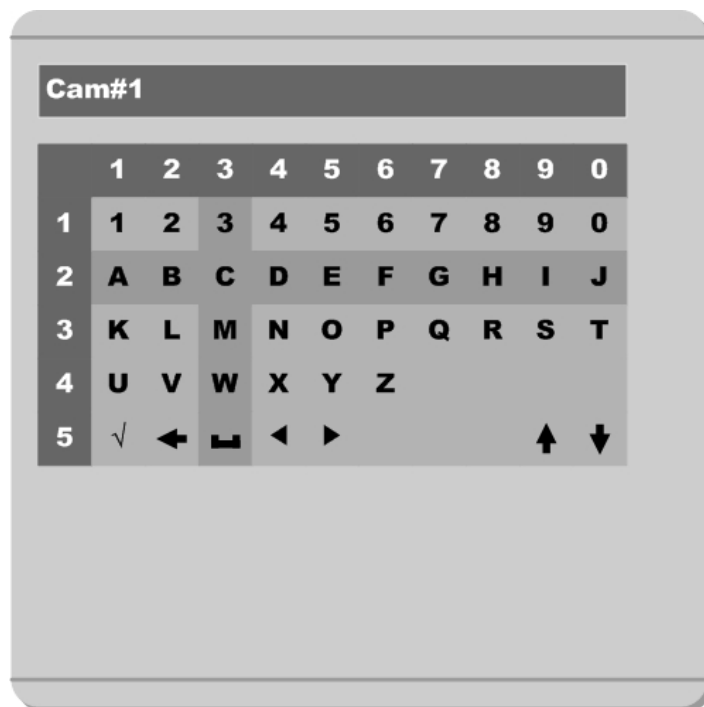

(1) Using number button

Enter the related numbers in order of horizontal/vertical. (For example, in order to select "C", press [3] and [2] buttons.)

(2) Using arrow button

Select a value using the [◀◀ / ▶▶] or [▲/▼] buttons. The intersection of the horizontal and vertical bar is selected value. Press the [▶] button to confirm the selected value.

(3) Function word

The following symbols are for executing specific functions:

- ✓ : Enter
- ← : Back Space & delete
- ␣ : Space
- ◀ : Move to left
- ▶ : Move to right
- ↑ : Previous Code Page
- ↓ : Next Code Page

6. Setting remote controller

6.1. Setting remote control DIP switch

Set the remote control DIP switch to “ON.”

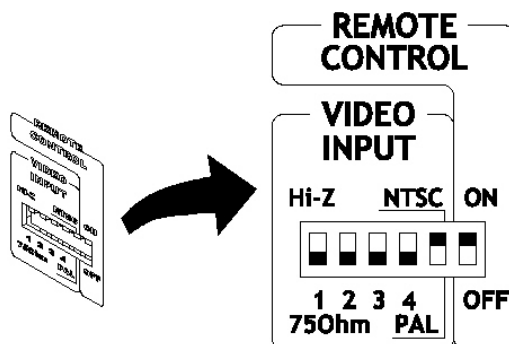

6.2. Set ID of HVR-04E

When controlling several HVR-04Es with one remote controller, set Remote Control ID as follows.



(1) Press [MENU] button.

(2) Select “System” with using [▶▶] button and press the [ENETR] or [▼] button.

- (3) Select “Miscellaneous” from the sub-menu list using the [▼] button and press the [ENETR] button.
- (4) Select “Remote Control ID,” and press the [ENETR] button.
- (5) Select a value using the [◀◀ / ▶▶] buttons and press the [EXIT] button.
- (6) Press the [EXIT] button to exit the Settings Page and return to Monitor mode.

<Note> Remote Control ID

Up to 16 HVR-04Es can be controlled with a single remote controller.

6.3. Selecting HVR-04E

If several HVR-04Es are set with unique ID numbers, they can be controlled with one remote controller. To select a specific HVR-04E, press the ID button of remote controller until the 8 LEDs on the front of the HVR-04E light up and a buzzer sounds.

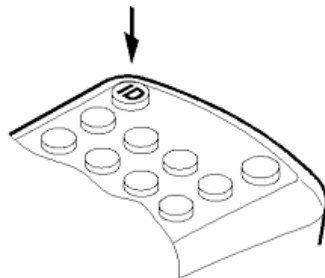

Remote Controller

Unselected	<p style="text-align: center;">STATUS ALARM</p> <p style="text-align: center;">○ ○ ○ ○ ○ ○ ○ ○</p> <p style="text-align: center;">PWR MET REC PLAY 1 2 3 4</p>
Selected	<p style="text-align: center;">STATUS ALARM</p> <p style="text-align: center;">● ● ● ● ● ● ● ●</p> <p style="text-align: center;">PWR MET REC PLAY 1 2 3 4</p> <p style="text-align: center;">All LED Blink One Time</p>

<Note>

Because remote controller ID is sixteen, HVR-04E will correspond.

6.4. Operable range of remote controller

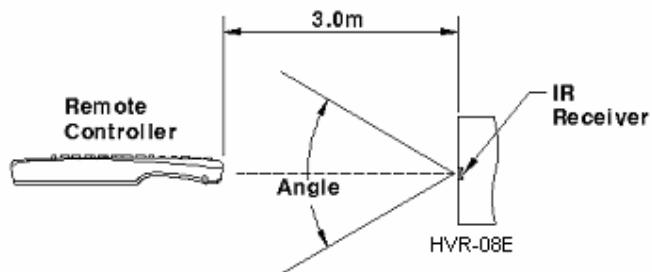

Horizontal Angle : $\pm 45^\circ$
 Vertical Angle : $\pm 60^\circ$

6.5. Loading the batteries into remote controller

Remote controller requires two AAA-type batteries.

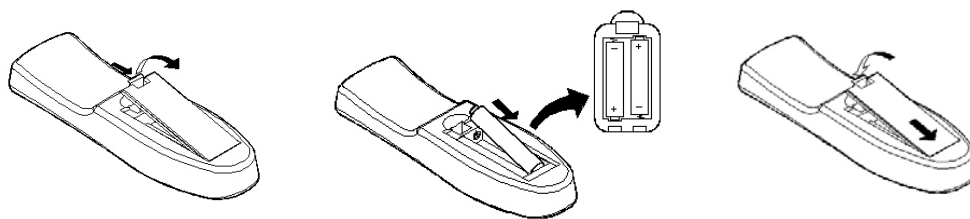

1. Remove the battery cover.

2. Taking care that the poles(+/-) are correctly positioned

3. Replace the battery cover.

<Note>
 Batteries are not included as a packing accessory.

7. HVR-04E Configuration

7.1. Basic Configuration

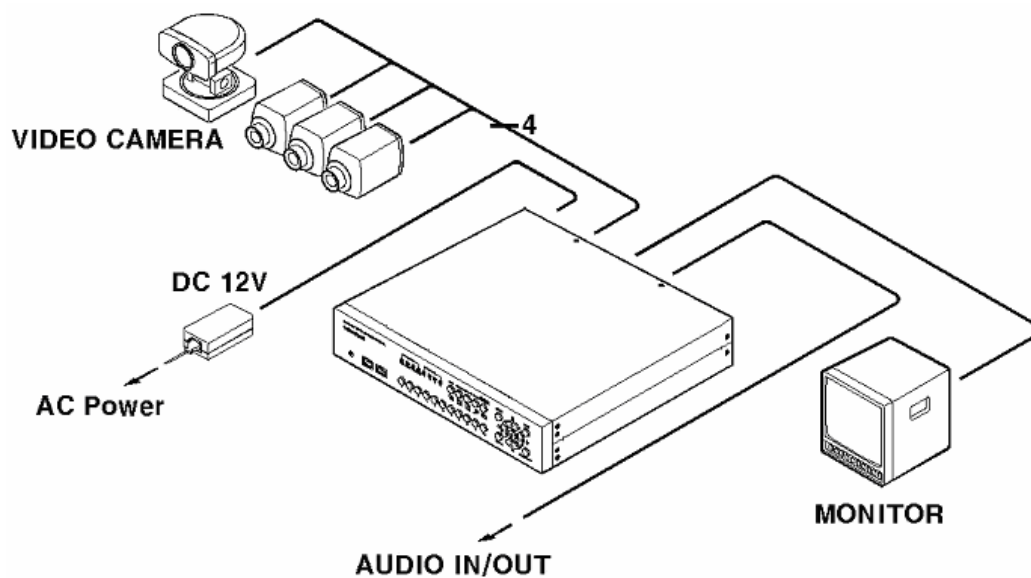

7.2. Advanced Configuration

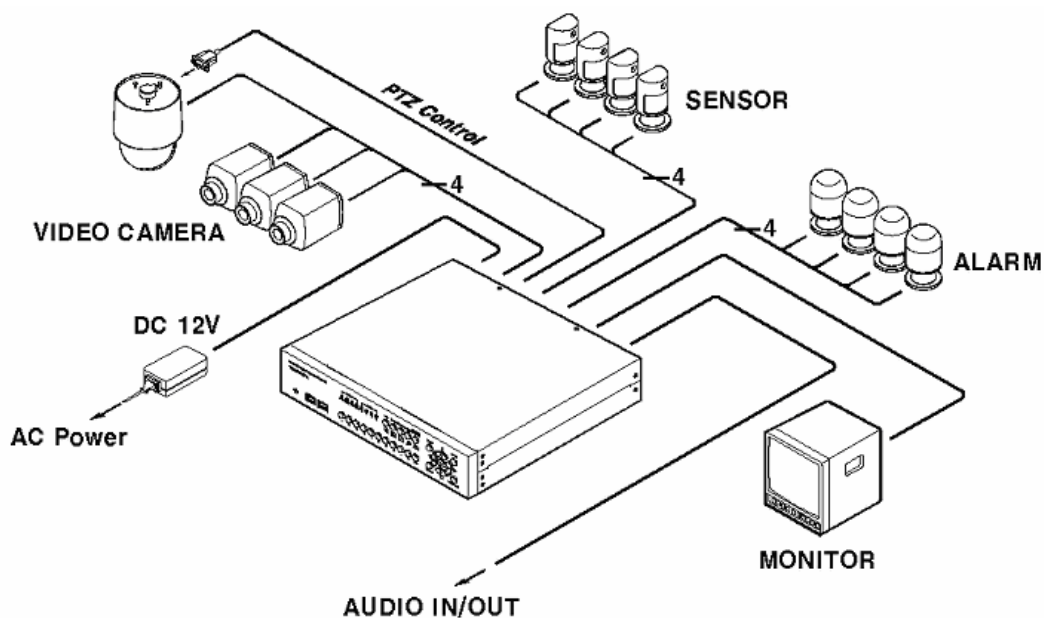

7.3. External Storage & Backup Configuration

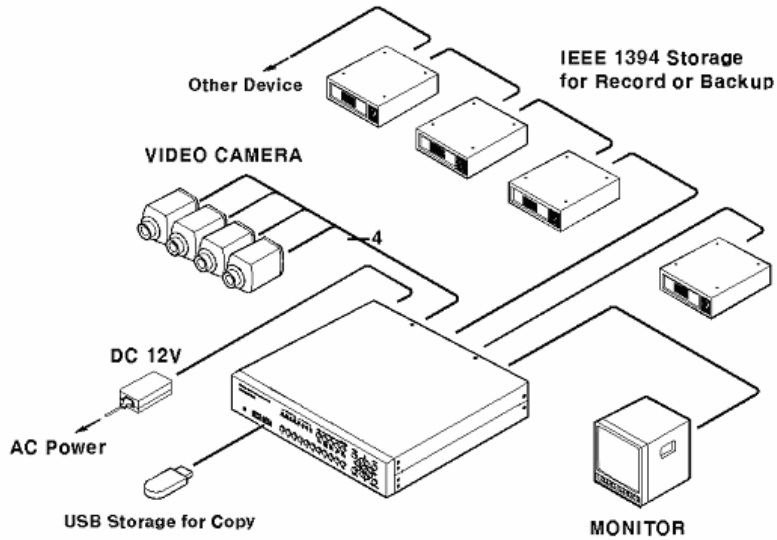

7.4. Internet/Intranet Configuration

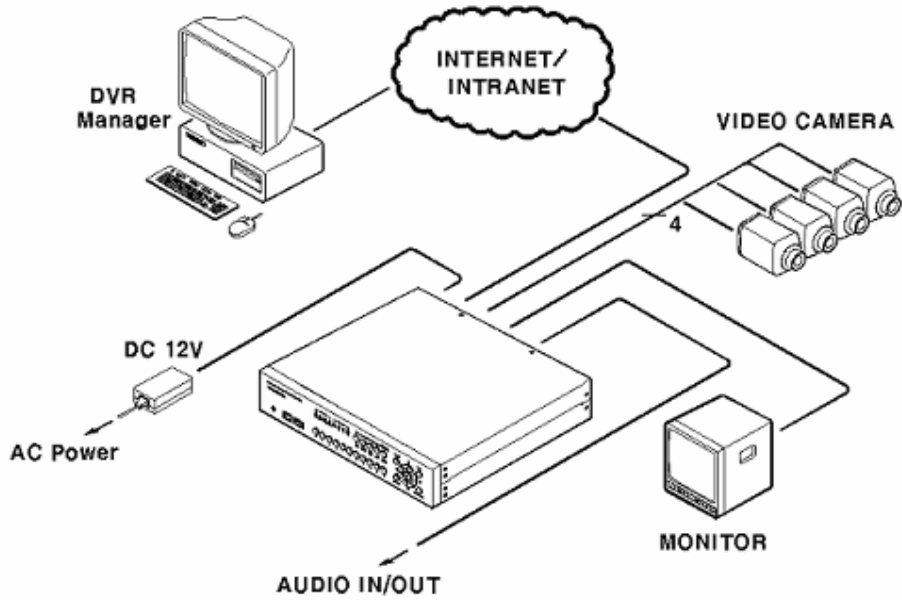

8. HVR-04E Basic Setting

8.1. Viewing Image

After initial start-up, images from Ch.1~4 are displayed in a quad-split screen.

<Note>

If user password is set, a prompt for entering the password will appear.



8.2. Setting Date & Time

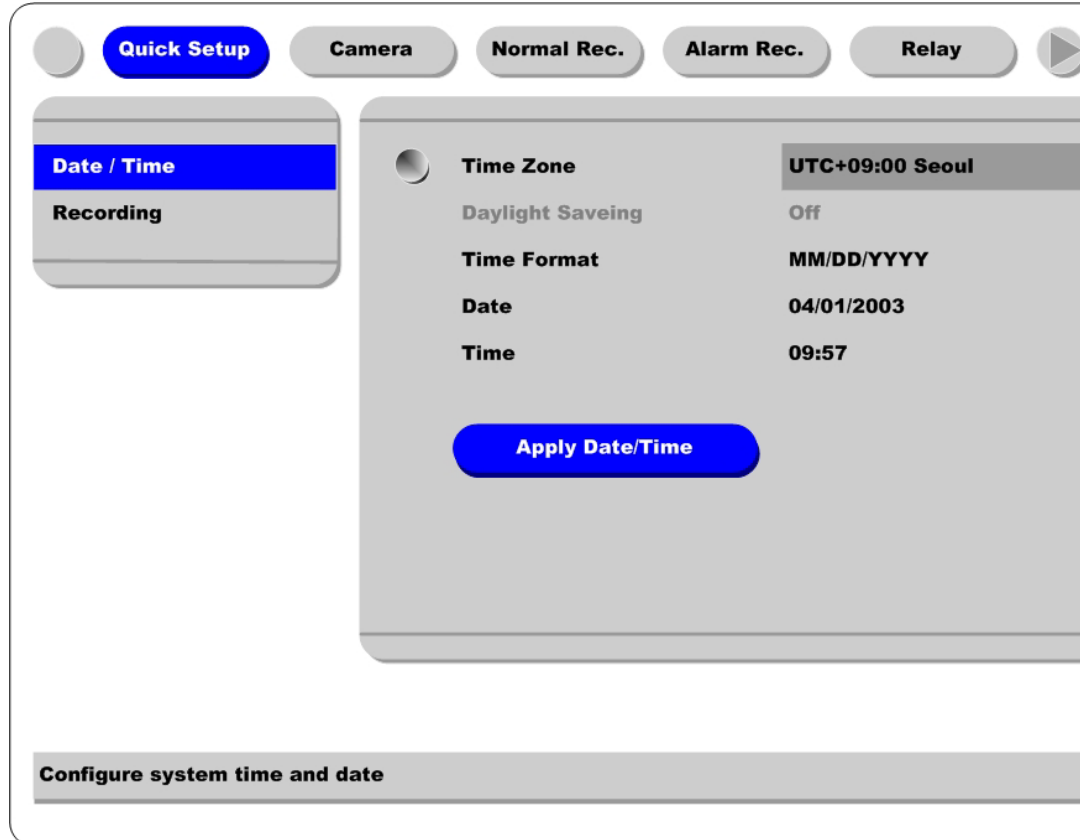

- (1) Press [MENU] button, and select “Quick Setup” tab.
- (2) Select “Date/Time” and enter the Settings Page by pressing [ENTER].

8.2.1. Time Zone

- (1) Select “Time Zone” and press [ENTER] button to configure.
- (2) Select a value using the [◀◀ / ▶▶] button and press the [EXIT] button when finished.

8.2.2. Daylight Saving

- (1) “Daylight Saving Time” is only activated for time zones that use Daylight Savings. If activated, press [ENTER] to enter a new value.
- (2) Select “On/Off” using the [◀◀ / ▶▶] button and press the [EXIT] button when finished.

8.2.3. Time Format

- (1) Select “Time Format” using the [◀◀ / ▶▶] or the [▲/▼] buttons and press [ENTER].
- (2) Two Time Formats are available; ‘MM/DD/YYYY’ and ‘YYYY/MM/DD’. Select a value using [▲/▼] buttons, and press the [EXIT] button when finished. (Default value is ‘MM/DD/YYYY’.)

8.2.4. Date

- (1) Select “Date” using the [◀◀ / ▶▶] or the [▲/▼] buttons and press [ENTER].
- (2) Select ‘MM’/‘DD’/‘YYYY’ using the [◀◀ / ▶▶] buttons, and select the value using the [▲/▼] buttons.
- (3) Press the [EXIT] button when finished.

8.2.5. Time

- (1) Select “Time” using the [◀◀ / ▶▶] or the [▲/▼] buttons and press [ENTER].
- (2) Select ‘HH’/‘MM’ using the [◀◀ / ▶▶] buttons, and select the value using the [▲/▼] buttons.
- (3) Press the [EXIT] button when finished.

8.2.6. Apply Date/Time

Most setting values are applied automatically, when exiting from the related menu page. But “Date” & “Time” settings are not applied automatically because they may critically affect the file system of the recorded HDD. To apply Date/Time settings confirm settings with [Apply Date/Time] button.

- (1) Select “Apply Date/time” using the [◀◀ / ▶▶] or the [▲/▼] buttons and press [ENTER]. A warning message will appear.
- (2) Select “OK” using the [◀◀ / ▶▶] or the [▲/▼] buttons and press [ENTER]. To cancel, press the [EXIT] button.

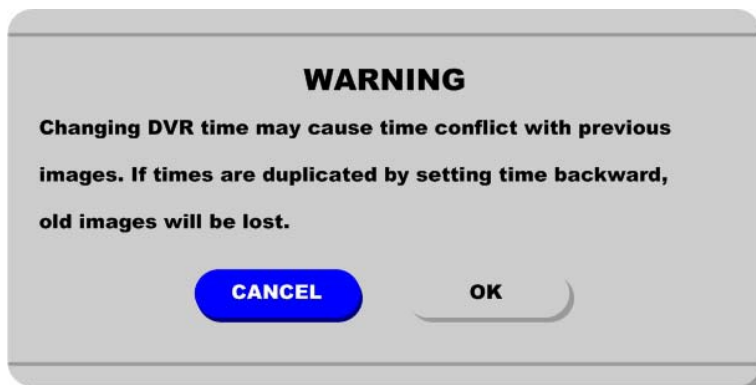

8.3. Setting Recording Condition

Recording conditions under the “Quick Setup” menu tab apply the same values to all analog channels 1~4. All settings are applied for 24 hours/day regardless of the values set for “Time Schedule” or “Alarm Rec.”

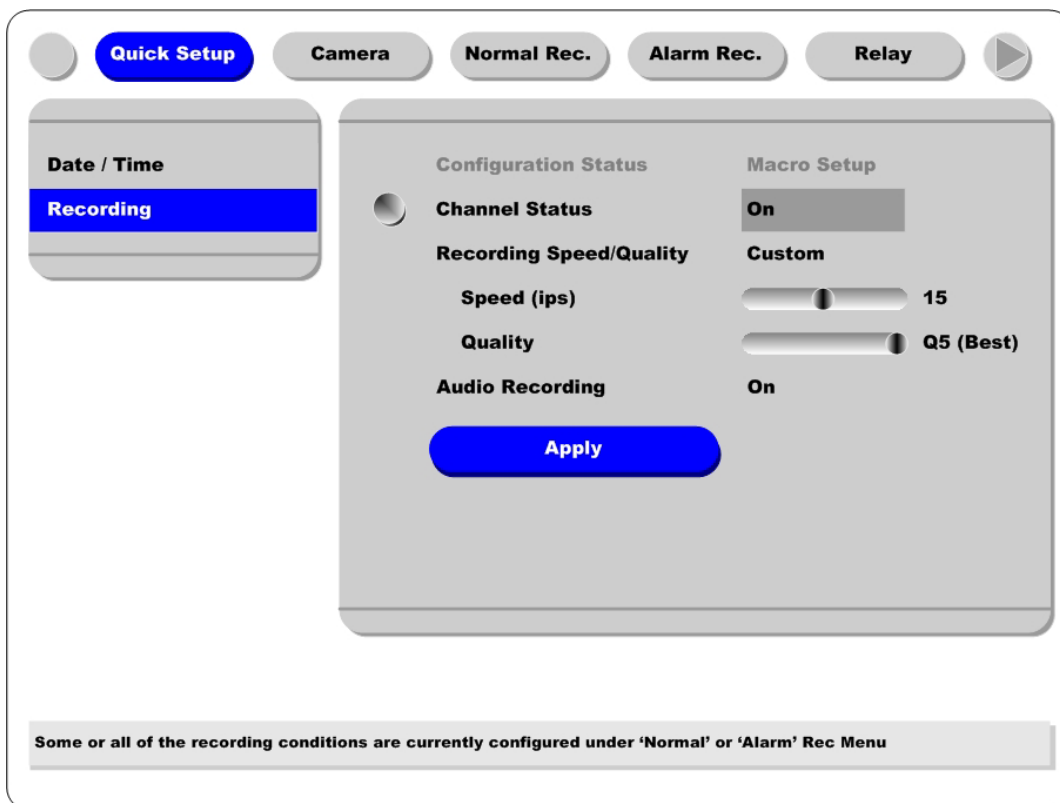

- (1) Press [MENU] button, and select “Quick Setup.”
- (2) Move to sub-menu by pressing [ENTER] or the [▼] button.
- (3) Select “Recording” using the [▲/▼] buttons and press the [ENTER] button.

8.3.1. Configuration Status

Displays the recording configuration status. When setting up through the “Quick Setup” menu, “Quick Setup” will be shown. When setting up through “Normal Rec.” or “Alarm Rec.,” “Custom Setup” will be shown.

<Note>

Only when all the 16 channels' normal recording conditions are set through 'Macro Setup' and maintained, it is marked as 'Macro Setup'. Otherwise, it will be marked as 'Custom Setup'.

8.3.2. Channel Status

- (1) Select “Channel Status” using [▲/▼] buttons and press the [ENTER] button.
- (2) Select a value using the [◀◀/▶▶] button. Press the [EXIT] button when finished.

8.3.3. Recording Speed/Quality

- (1) Select “Recording Speed/Quality” using [▲/▼] buttons and press the [ENTER] button.
- (2) Select a value using the [◀◀/▶▶] button. Press the [EXIT] button when finished.

<Note> Recording Speed/Quality means

- Low : Speed=1ips and Quality=Q5
- Std. : Speed=5ips and Quality=Q5
- High : Speed=15ips and Quality=Q5
- Custom : Manually defined by User.

8.3.4. Speed(ips)

When “Recording Speed/Quality” is set as “Custom,” values can be set manually.

- (1) Select “Speed” using [▲/▼] buttons and press the [ENTER] button.
- (2) Select a value using the [◀◀/▶▶] button. Press the [EXIT] button when finished.

8.3.5. Quality

When “Recording Speed/Quality” is set as “Custom,” values can be set manually.

- (1) Select “Quality” using [▲/▼] buttons and press the [ENTER] button.
- (2) Select a value using the [◀◀/▶▶] button. Press the [EXIT] button when finished.

8.3.6. Audio Recording

- (1) Select “Audio Recording” using [▲/▼] buttons and press the [ENTER] button.
- (2) Select a value using the [◀◀/▶▶] button. Press the [EXIT] button when finished.

8.3.7. Apply

- (1) Select “Apply” using [▲/▼] buttons and press the [ENTER] button.
- (2) Setting values are applied and the previous menu will be displayed.

9. Connecting and Configuring Sensor

9.1. Connecting Sensor Input

To connect a sensor to S1, fix the wire to “S1” and “G”.

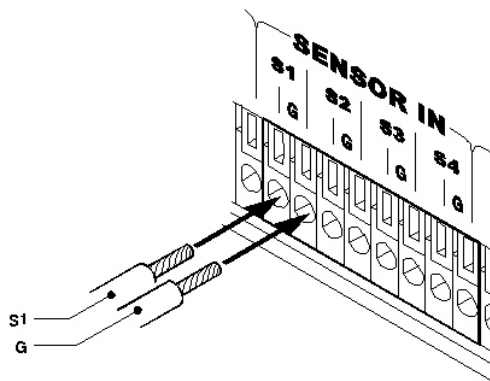

<Note>

Devices connected to the sensor input should have “Dry contact.” The following diagram is of an electric circuit with approximately 12mA flows.

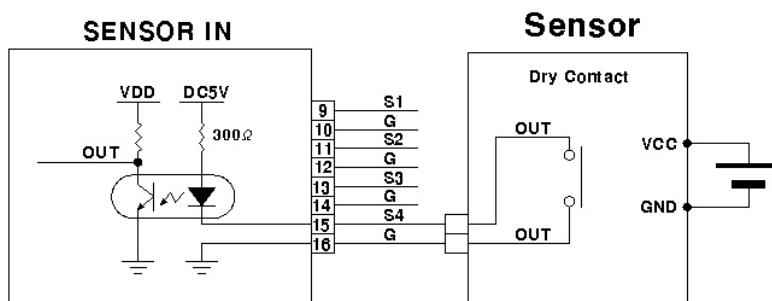

9.2. Setting Sensor at OSD menu



After a sensor is connected, it can be activated through the OSD Configuration menu.

Select the sensor number (S1, S2, etc.) and press the [Enter] button to configure. Use the [◀◀ / ▶▶] buttons to select “On” or “Off.” Press [EXIT] when finished.

<NOTE>

When activated, the “Pre / Post Alarm” function will cause the HVR-04E to record images at the specified Speed and Quality for a length of time before and/or after the sensor is triggered.

10. Connecting & Configuring Relay Out

10.1. Connecting Relay Out

HVR-04E has total four ports of Relay Out.

To connect a device to “O1,” connect the wires to two “O1”s.

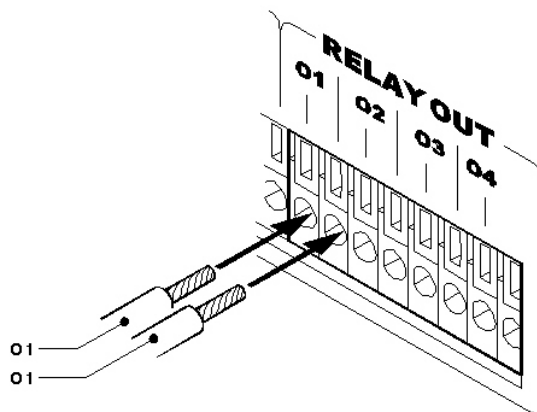

<Note>

The rated voltage and current of Relay Out are as follows. Do not exceed the rated values.

Maximum Switching Capacity	24V DC, 1.25A, 30W
	125V DC, 0.24A, 30W
	125V AC, 0.5A, 62.5VA

10.2. Configuring Relay Out

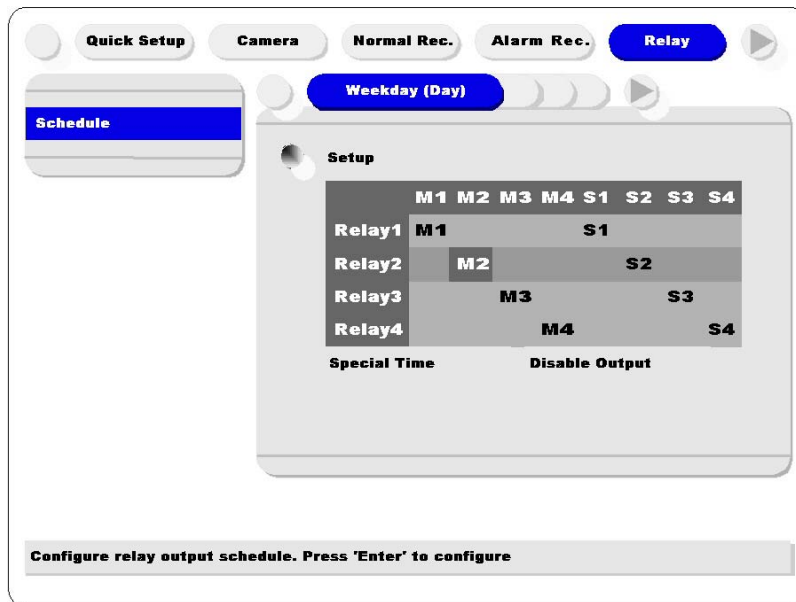

Each relay can be synchronized with a sensor input or with motion detection for each of the four time schedules (Weekday (Day), Weekday (Night), Weekend (Day), Weekend (Night)). Relays can also be controlled locally by pressing the [SEARCH/RELAY] button followed by the relay number (1-4). Relays can also be controlled remotely through the “DVR Manager Software.”

11. Connecting External Device with Serial Port

11.1. Connecting Text Input Device (ATM / POS / Access Control)

In addition to images, the HVR-04E can record text data received from POS/ATM through the RS232 serial port.

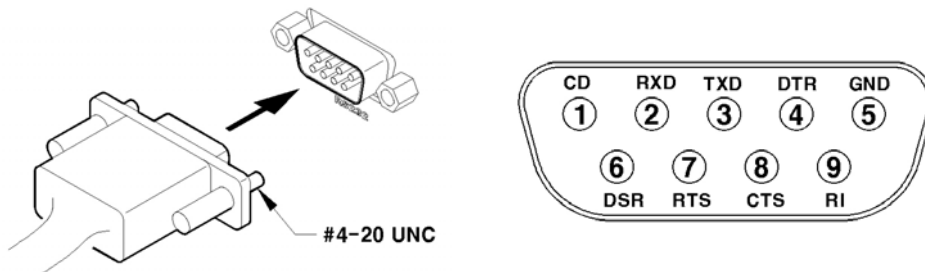

Connect RS232 to 9pin D-sub of HVR-04E, and configure the “Text” sub-menu under the “System” tab.

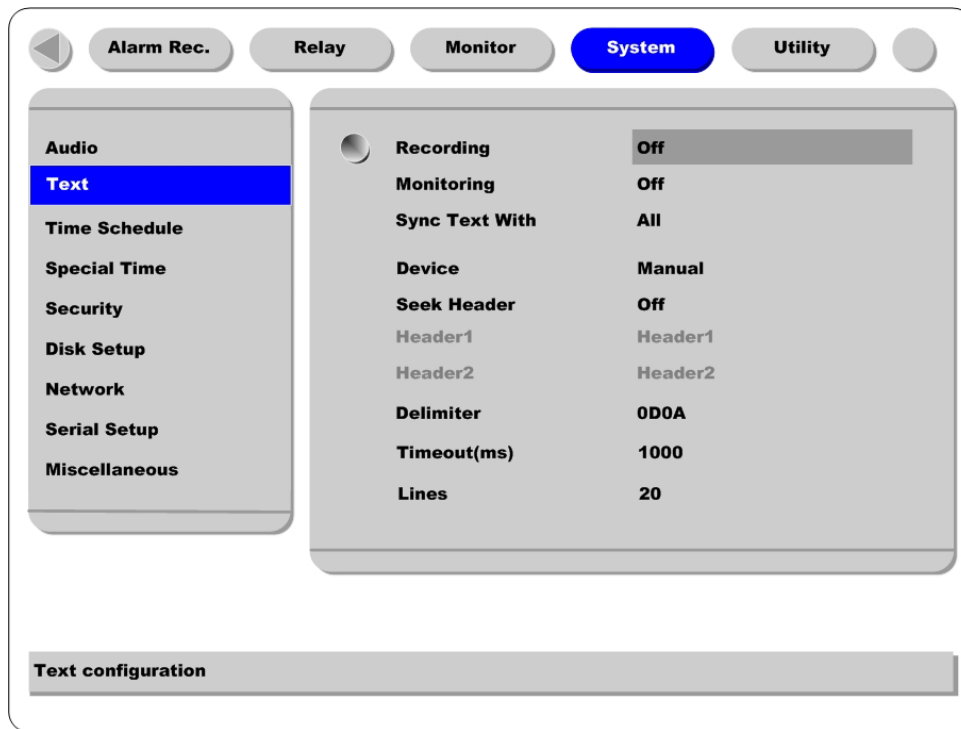

Set “Serial Setup” under the “System” menu tab to “RS232” and “Device” to “Text.” The baud rate may differ for each device; consult the device manual for more information.

<Note>

Before installing any external device, consult with the local HUNT ELECTRONIC USA, INC. distributor. Some external devices may not be compatible with the HVR-04E.

12. Connecting & Configuring Serial Ports for Pan/Tilt/Zoom

12.1. Connecting Serial Port

The HVR-04E has most major PTZ protocols already pre-programmed. Makes and models not supported can still be controlled using the Transparent Protocol. For a list of supported protocols, refer to the list on the OSD Configuration menu.

12.1.1. Connecting RS232

Fix the wire to 1~3 pins (RX, TX, GND).

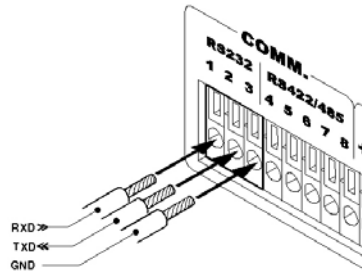

12.1.2. Connecting RS485

Fix the wire to 4~5 pins and 8 pin (R+, R-,GND).

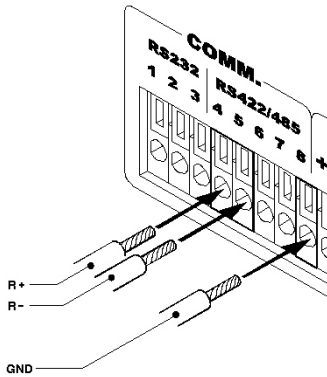

12.1.3. Connecting RS422

Fix the wire to 4~8 pins (R+, R-, T+, T-, GND).

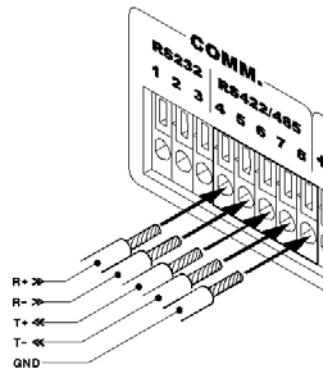

12.2. Configuring Serial Port

Configure PTZ serial ports and available modes at “System / Serial Setup”.

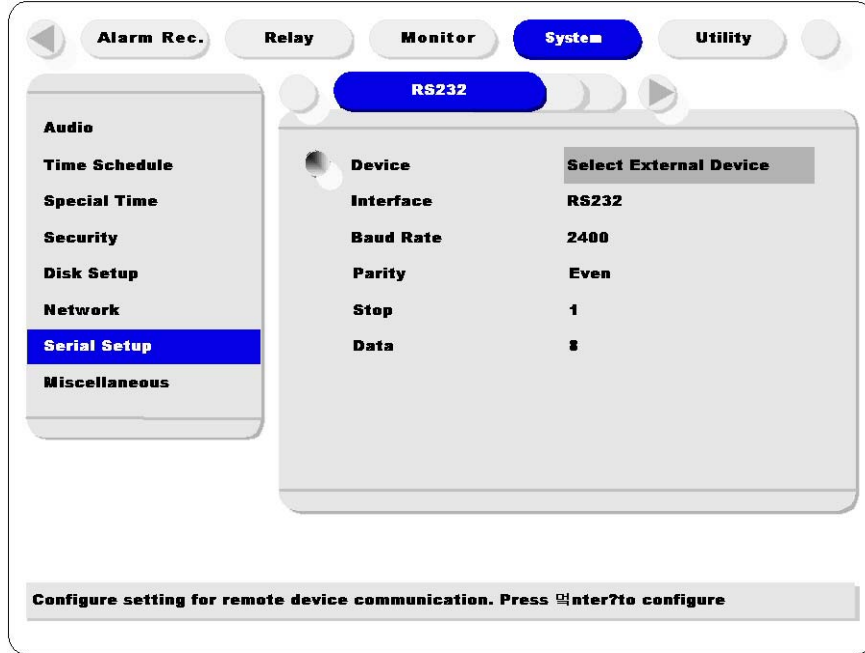

After completing serial setup, configure base address and port for each channel under the “Camera” menu tab. When connecting PTZ devices to several cameras, be sure the base address matches the address for the camera.

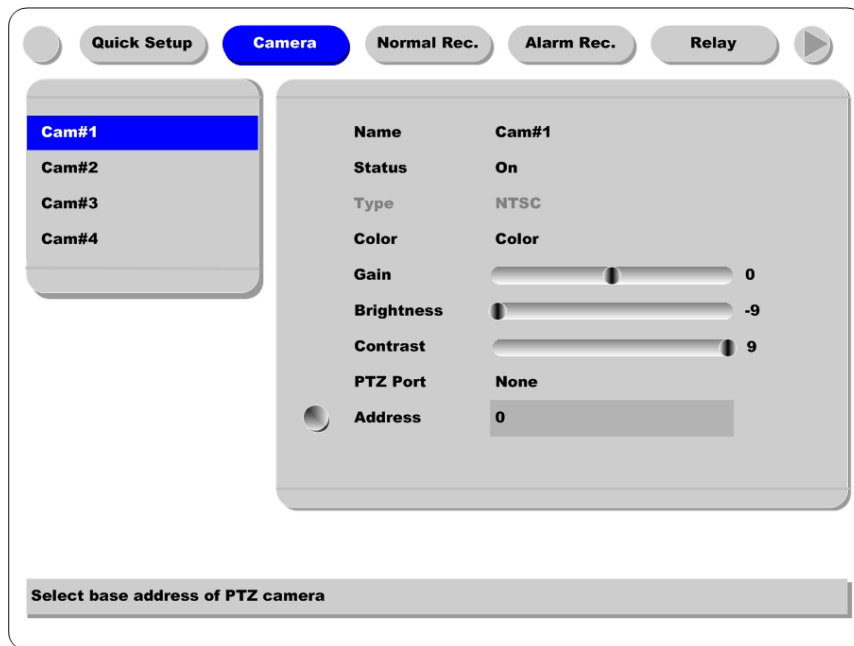

<Note> Wire Handling

Trimming Wire

When connecting a wire to a terminal block, follow the instructions below. Note the different types of wire that can be used.

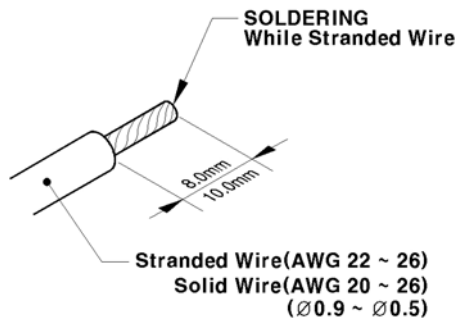

Stranded Wire: Peel off the wiring cover 8~10mm and solder it. Wire gage should be AWG 22 ~ 26.

Solid Wire: Peel off the wiring cover 8~10mm and solder it. Wire gage should be AWG 20 ~ 26.

Inserting & removing wire

To insert the wire, use a screwdriver as shown in the diagram to the right.

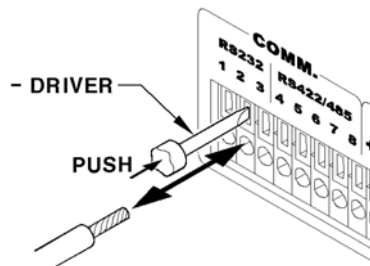

13. Connecting USB Device

USB port can be used to copy up to 1 minute of images to a USB Flash memory disk. When connecting USB device, do not exceed the rated values of USB device.

USB Spec.	Ver 1.1 (Max 12M bps)
Available Device	USB Memory Stick,
Output Voltage/Current	Max. 200mA per DC 5V / Port

<Note>

The disk should be formatted with FAT32 type.

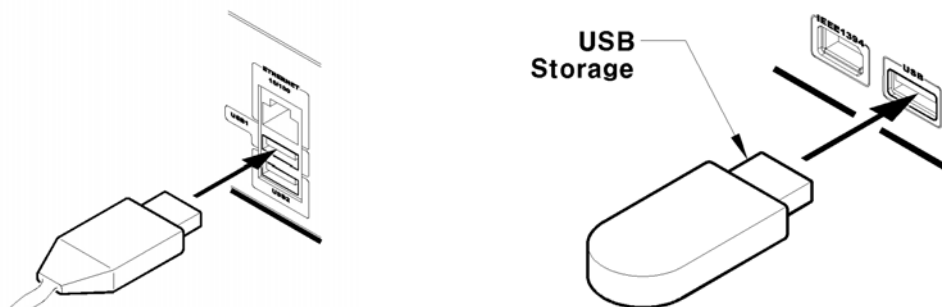

If properly connected, the disk is recognized automatically as in the following picture. To copy images, the process is as follows: Set copy range (up to 1 minute) → Select drive → Copy (press “Start”).

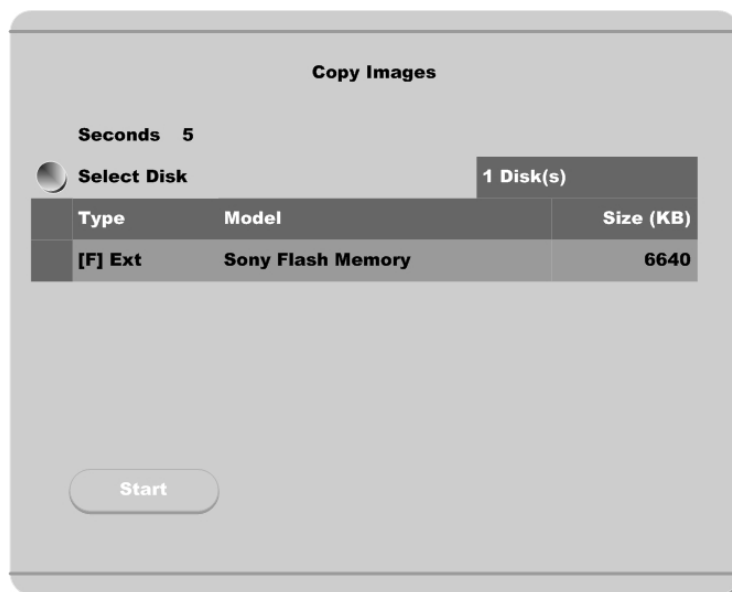

<Note>

USB Flash products that require a Windows program to operate may not be recognized by the HVR-04E.

14. Connecting External Storage

14.1. IEEE1394 Bay

HVR-04E has three IEEE1394 ports for external storage device interface. With them, HVR-04E can expand storage capacity up to 4TB.

<Note>
Some IEEE1394 Bay may not be recognized by the HVR-04E. Before purchasing, consult the local HUNT ELECTRONIC USA, INC. distributor.

14.2. Connecting IEEE1394 Device

When using FireWire supported external HDD, hard drive bays can be connected to 1 port in the front panel or 2 ports in the rear panel. The HVR-04E does not supply power to the hard drive bay; therefore only bays that use external power can be used.

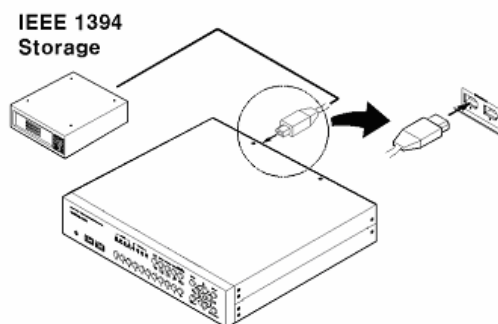

14.3. Available HDD

It is recommended to use the following HDD models with the HVR-04E. If a non-recommended HDD is used, Hunt Electronic USA, Inc. will not guarantee the warranty.

Manufacturer : **MAXTOR**

Series	Model No.	Size	Series	Model No.	Size
DiamondMax Plus 9 (7200rpm)	6Y060L0	60GB	DiamondMax 16 (5400rpm)	4R060L0	60GB
	6Y080L(P)0	80GB		4R080L0	80GB
	6Y120L(P)0	120GB		4R120L0	120GB
	6Y160L(P)0	160GB		4R160L0	160GB
	6Y200P0	200GB			
	6Y250P0	250GB			

<Note>
Buffer for DiamondMax Plus 9's model "L" is 3MB; for model "P" the buffer is 8MB.

14.4. Registering & Formatting HDD

“Disk Manager” will automatically run on start-up after installing a HDD.

If “Disk Manager” does not automatically run on start-up, make sure the HDD is properly installed.

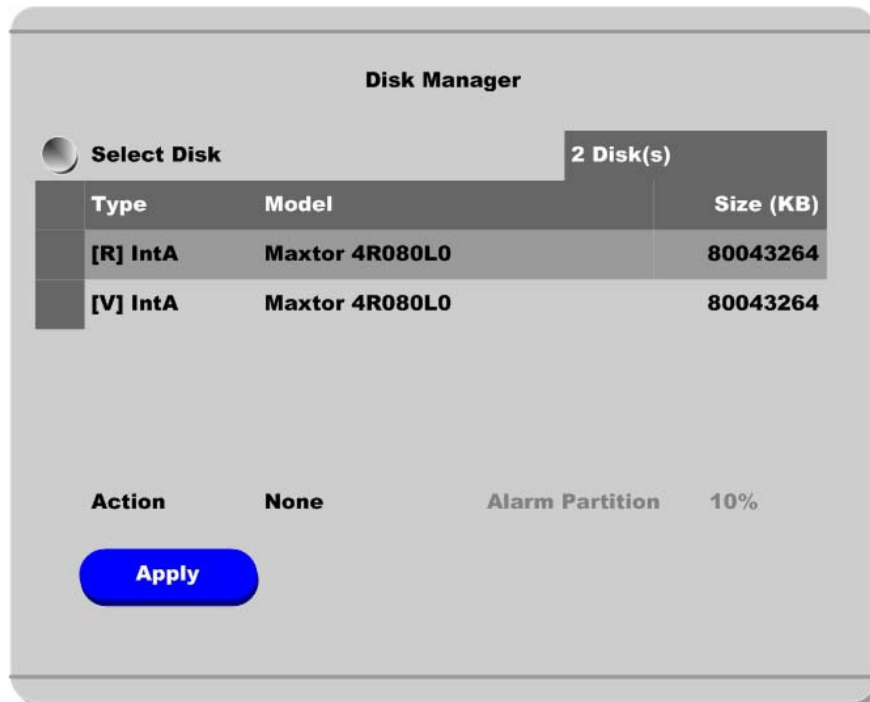

- (1) Press [ENTER] button at “Select Disk”.
- (2) Select new added HDD (indicated as “[F]”) using [▲/▼] button and press [EXIT] button
- (3) Select “Action” using [▲/▼] button and press [EXIT] button.
- (4) Select “Add” using [◀◀ / ▶▶] button and press [EXIT] button.
- (5) Select “Apply” using [▲/▼] button and press [EXIT] button. The HDD status is changed to “[*]”.
- (6) Select “Action” using [▲/▼] button and press [EXIT] button.
- (7) Select “Format” using [◀◀ / ▶▶] button and press [EXIT] button.

(8) Select “Apply” using [▲/▼] button and press [EXIT] button. The HDD status is changed to “[R]” after formatting.

(9) Shut down “Disk Manager” by pressing [EXIT] button.

15. Network Monitoring & Managing

HVR-04E can be accessed, controlled, and managed from remote site via Internet/Intranet.

15.1. Connecting Ethernet

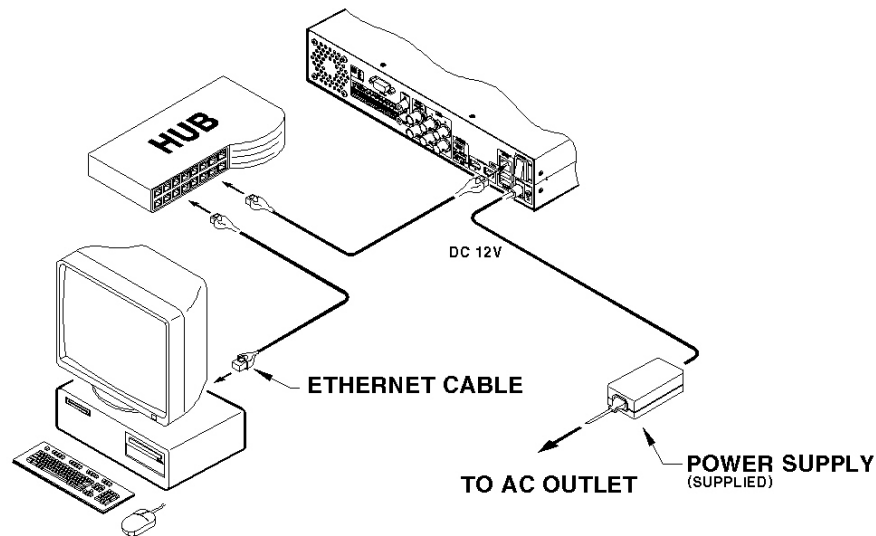

- 1) Turn off HVR-04E's power switch.
- 2) Connect HVR-04E to hub with Ethernet cable.
- 3) Turn on HVR-04E's power switch.

<Note>

1. Supply power to HVR-04E after connecting Ethernet cable to protect against electrical damage to HVR-04E.
2. Check cable connection status.
3. Check LED on HVR-04E's rear panel after supplying power.

15.2. Configuring HVR-04E's Network Information

The following description is on based on Ethernet connection. For more detailed information on the Network Settings Page, please refer to “HVR-04E OSD User’s Guide”.

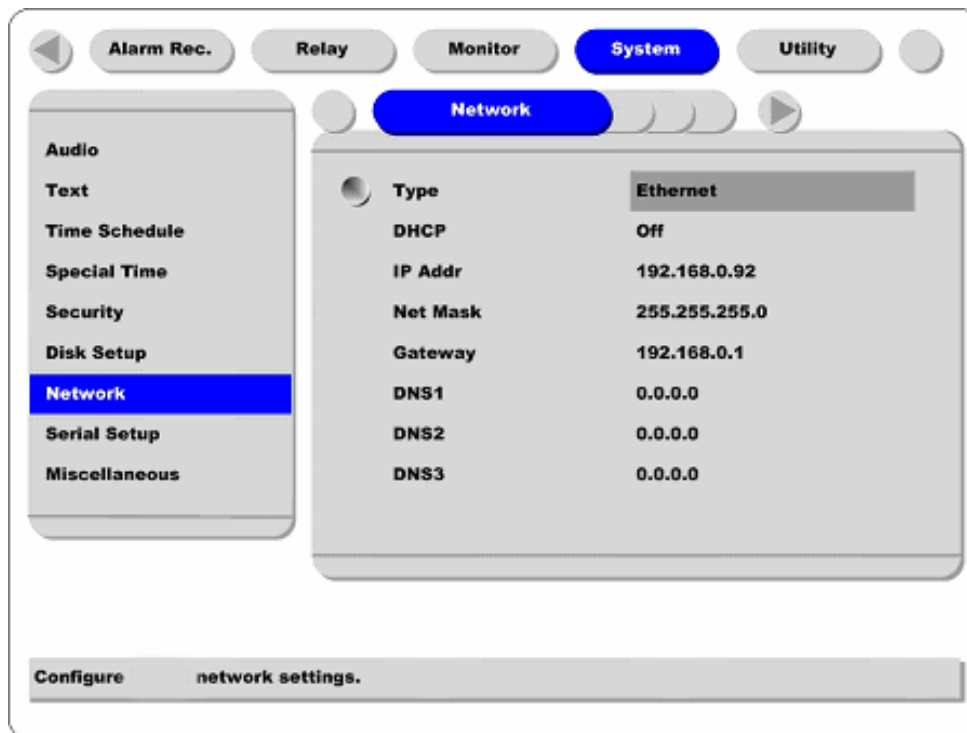

- (1) Press [MENU] button.
- (2) Select “System” using the [◀◀ / ▶▶] buttons and press [ENTER].
- (3) Select “Network” using the [▲/▼] buttons and press [ENTER].
- (4) Select “IP Addr” using the [▲/▼] buttons and press [ENTER].
- (5) Press [EXIT] button after entering IP address in the dialogue box.
- (6) Select “Net Mask” using the [▲/▼] buttons and press [ENTER].
- (7) Press [EXIT] button after entering Net Mask in the dialogue box.
- (8) Select “Gateway” using the [▲/▼] buttons and press [ENTER].
- (9) Press [EXIT] button after entering Gateway in the dialogue box.
- (10) Select “DNS” using the [▲/▼] buttons and press [ENTER].
- (11) Press [EXIT] button after entering DNS in the dialogue box.
- (12) Press [EXIT] button to exit the page.

16. Using DVR Manager

16.1. PC System Requirements for running DVR Manager

	Minimal Requirements	Recommended Requirements
CPU	P-III 600MHz or above	P-III 1GHz or above
RAM	128 MB or above	256 MB or above
VGA	16 MB or above	32 MB or above
OS	Windows 2000/XP	Windows 2000/XP
Resolution	1024 X 768 pixels or above	1024 X 768 pixels or above
Network	100 Base TX Fast Ethernet	100 Base TX Fast Ethernet

16.1.1. Installing DVR Manager

- (1) Insert Setup CD-ROM into CD-ROM drive of administrator's PC
- (2) Doubleclick the DVR Manager setup file. Install Shield Wizard will be automatically installed.
- (3) Click the "I Agree" button to accept the license agreement



(4) Select which components to install and press the “Next” button.

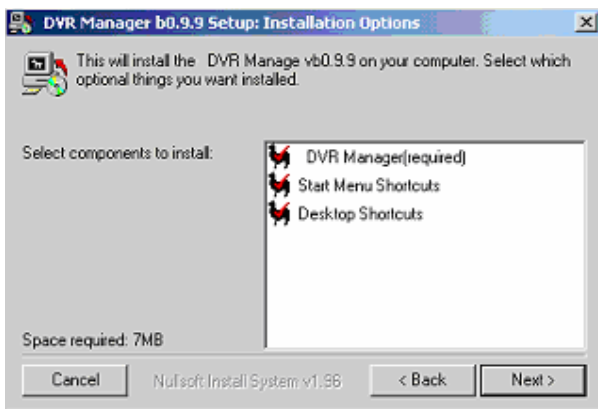

(5) Browse and choose a directory if the default directory is not preferred. Click the “Install” button, after selecting a directory to install.

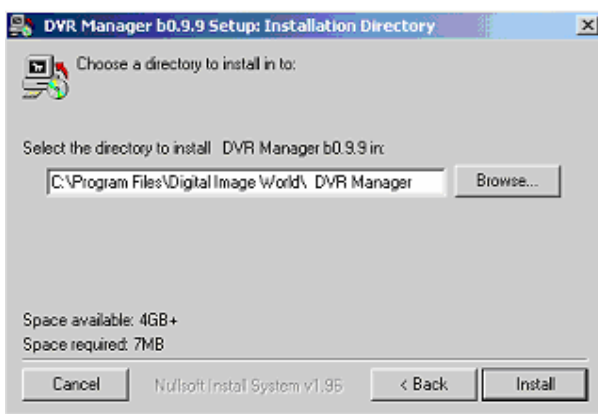

(6) Click the “Close” button after DVR Manager program is installed successfully

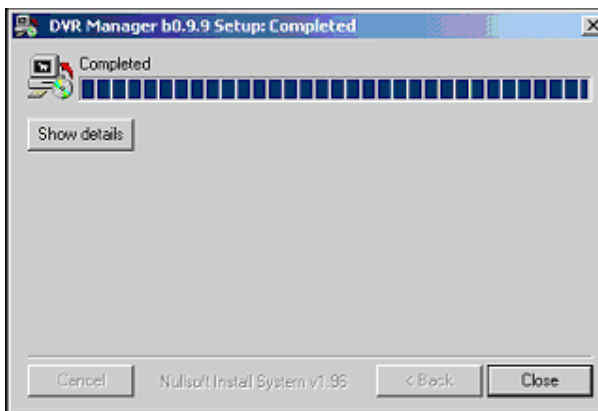

16.1.2. Uninstalling DVR Manager

- (1) Click Windows “Start” Button.
- (2) Select and Click ‘Uninstall’ icon to run Uninstall Shield.

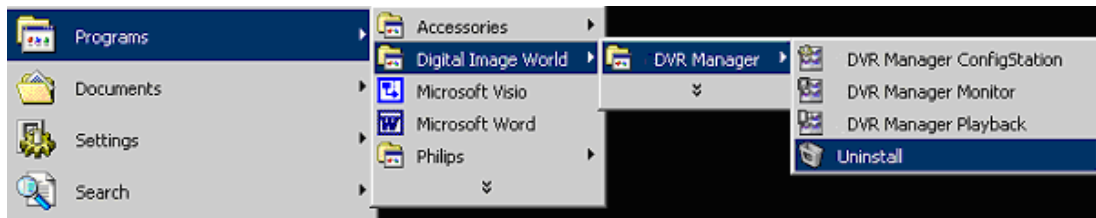

- (3) DVR Manager program will be automatically deleted.

16.2. Configstation



Click icon on desktop to run “DVR Manager Configstation” program.

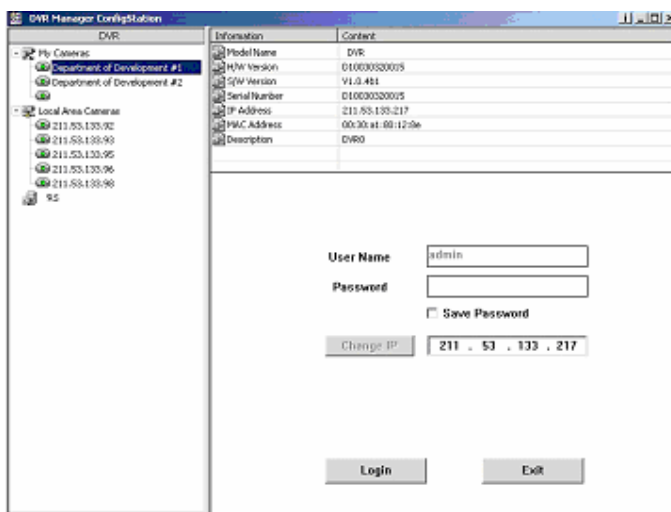

16.3. Monitor



Click the related icon and run the “DVR Manager Monitor” program.

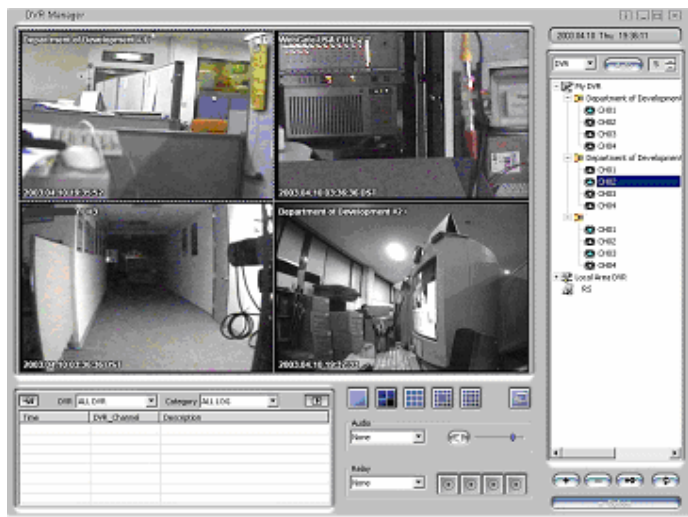

16.4. Playback



Click the related icon and run the “DVR Manager Playback” program.

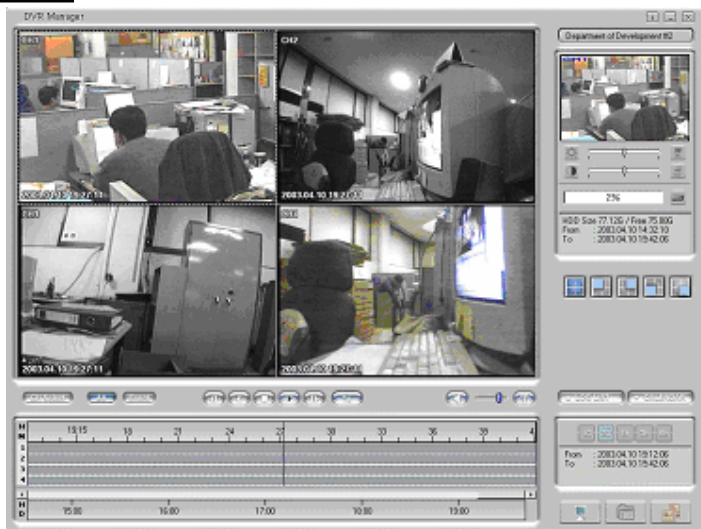

APPENDIX

Appendix #1 Installing and Replacing internal HDD

Compatible HDD

It is recommended to use the following HDD models with the HVR-04E. If a non-recommended HDD is used, Hunt Electronic USA, Inc. will not guarantee the warranty.

Manufacturer : **MAXTOR**

Series	Model No.	Size	Series	Model No.	Size
DiamondMax Plus 9 (7200rpm)	6Y060L0	60GB	DiamondMax 16 (5400rpm)	4R060L0	60GB
	6Y080L(P)0	80GB		4R080L0	80GB
	6Y120L(P)0	120GB		4R120L0	120GB
	6Y160L(P)0	160GB		4R160L0	160GB
	6Y200P0	200GB			
	6Y250P0	250GB			

<Note>

L series of DiamondMax Plus 9 has 3MB buffer memory, while P model has 8MB

Installing & Replacing

Adding or replacing HDD should follow below process

- (1) Turn off the power of HVR-04E.
- (2) Check whether the dip switches are set as illustrated below

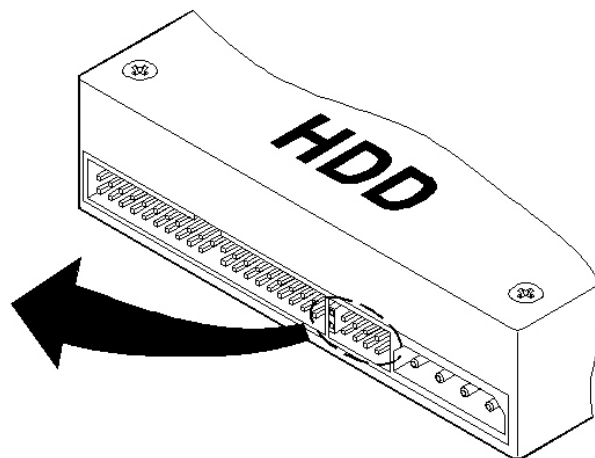
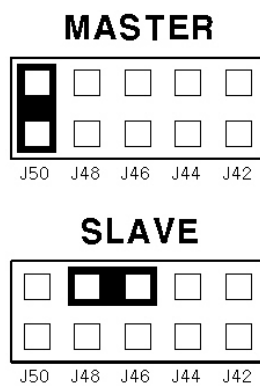

<Note>

The dip switch should be set at 'MASTER' position for the first installed or built-in HDD. Additional HDD should be set as 'SLAVE.' Identical dip switch setting may cause system conflict or mal-function.

(3) Remove the 6 screws as illustrated below and pull up the cover from the rear part to open

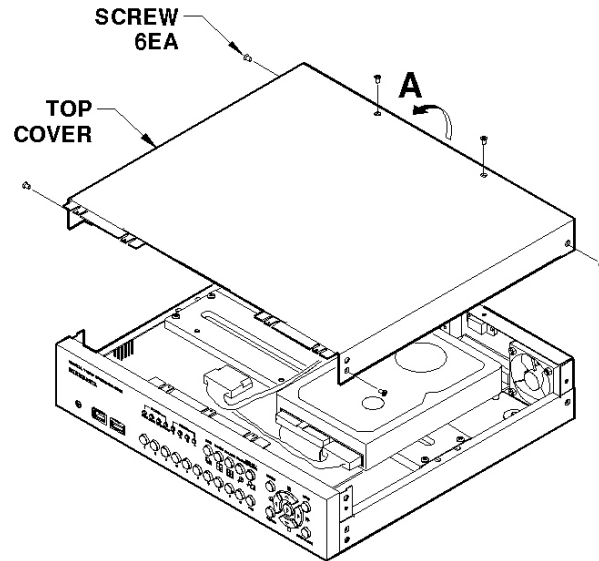

(4) Take out power and data cable of HDD from Main PCB ASS'Y. Remove 4 HDD Bracket screws and take out HDD ASS'Y.

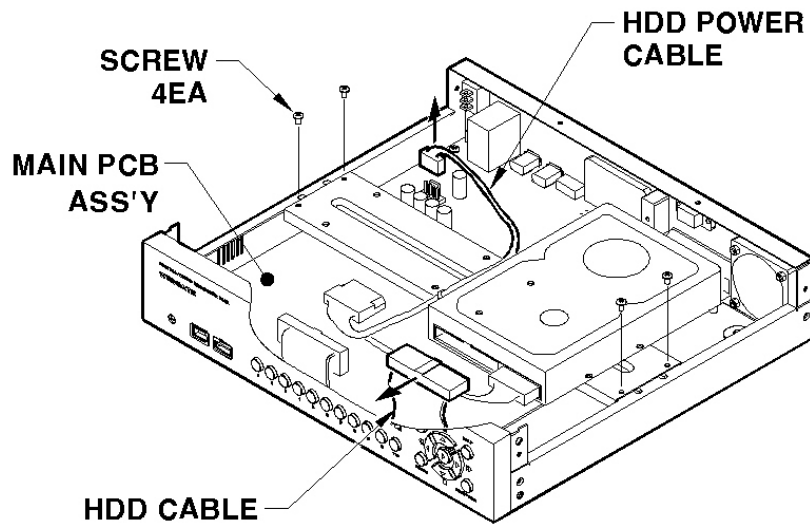

(5) Fix the HDD with provided screws. Connect power and data cables to HDD

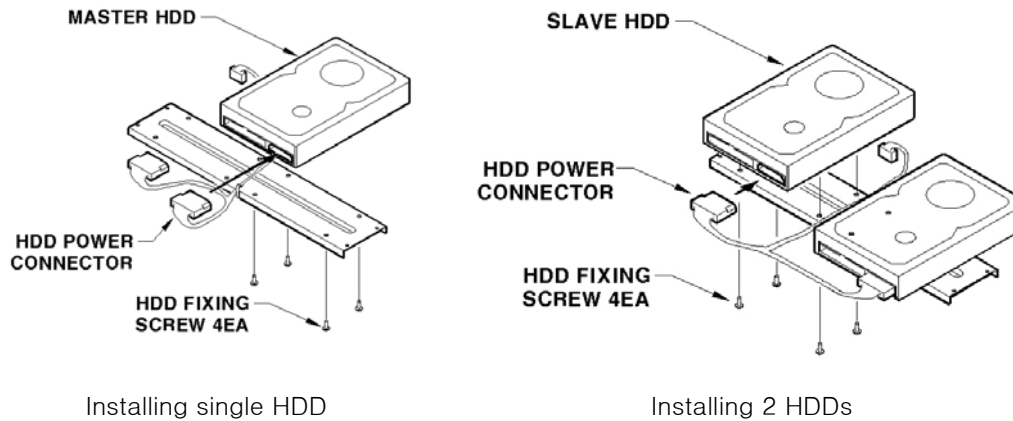

<Note> Caution for HDD Management

1. Replacing 'SLAVE' HDD of internal 2 HDDs causes permanent data loss in the SLAVE HDD.
2. MASTER HDD has all the index of stored data including 'SLAVE' HDD. Corruption on 'MASTER' HDD may cause total data loss. Be careful when handling the main HDD.
3. It is strongly recommended that MASTER HDD should be backed up before replacing

(6) Connect HDD power cable to main PCB ASS'Y. Secure the HDD with screws.

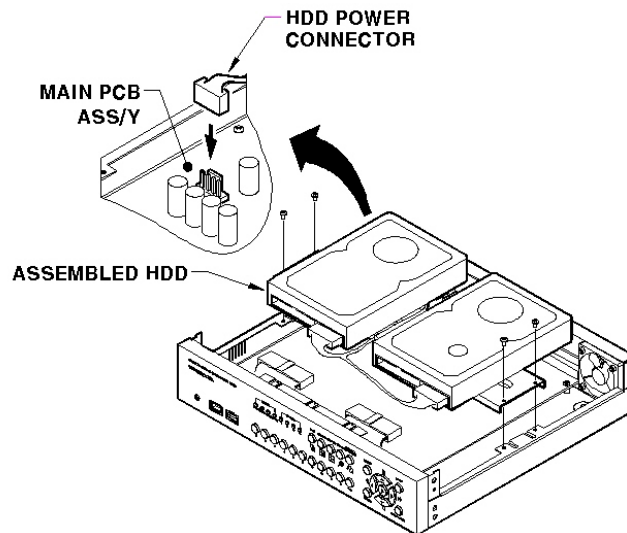

(7) Connect HDD cable's connector to HDD as in the following picture.

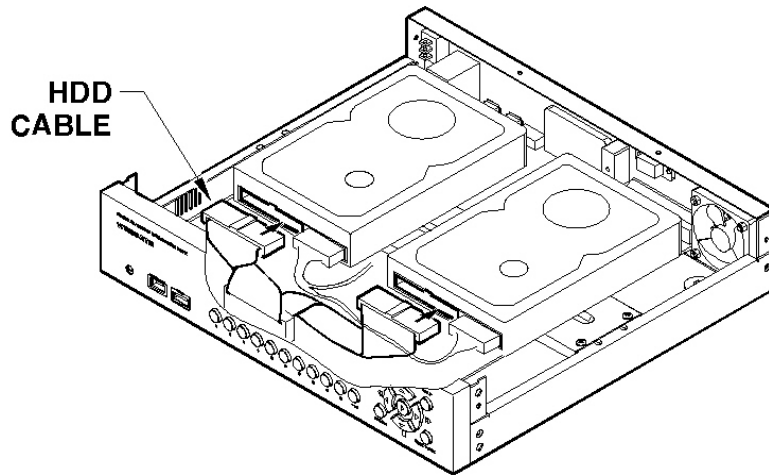

(8) Assemble the top cover.

Registering & Formatting HDD

“Disk Manager” will automatically run on start-up after installing a HDD. If “Disk Manager” does not automatically run on start-up, make sure the HDD is properly installed.

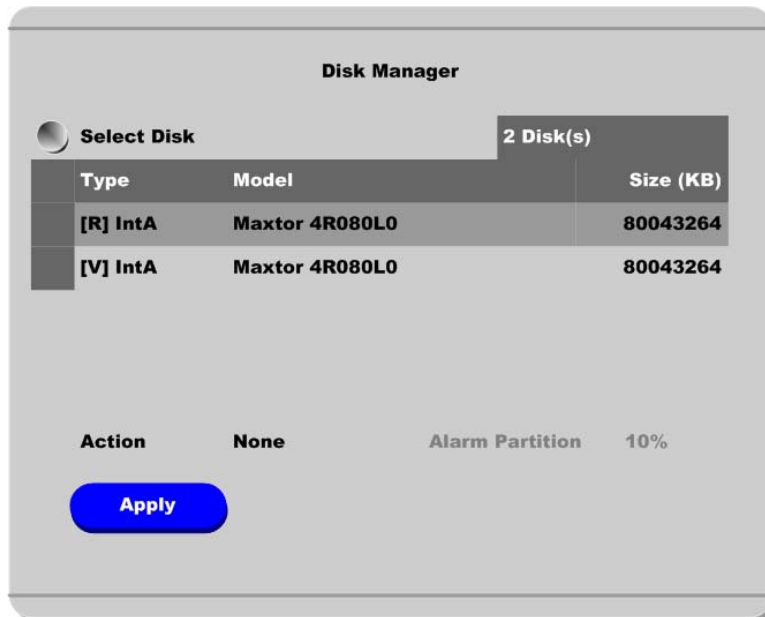

(9) Press [ENTER] button at “Select Disk”.

(10) Select new added HDD (indicated as “[F]”) using [▲/▼] button and press [EXIT] button

- (11) Select “Action” using [▲/▼] button and press [EXIT] button.
- (12) Select “Add” using [◀◀/▶▶] button and press [EXIT] button.
- (13) Select “Apply” using [▲/▼] button and press [EXIT] button. The HDD status is changed to “[*]”.
- (14) Select “Action” using [▲/▼] button and press [EXIT] button.
- (15) Select “Format” using [◀◀/▶▶] button and press [EXIT] button.
- (16) Select “Apply” using [▲/▼] button and press [EXIT] button. The HDD status is changed to “[R]” after formatting.
- (17) Shut down “Disk Manager” by pressing [EXIT] button.

<Note> HDD Type at Disk Manager

1. [R] Available of recording
2. [V] Connected and formatted as HVR-04E’s file system
If using ‘Add used’ command, it will be changed to [R]. There is no need to reformat.
3. [F] Connected but not available file system. After using ‘Add’, need to format for making as [R].
4. [*] Connected and added using the ‘ADD’ command. If formatting, it will be [R].
5. [X] HDD cable is not

<Note> HDD Managing Command

1. Format : Format as HVR-04E’s file system. Not available to PC file system.
2. Add : Add HDD for recording. Need to format.
3. Add Used : Add a HDD that has been used and formatted. There is no need to reformat
4. Remove : Remove current HDD. HDD can be reused without data loss by the ‘Add Used’ command.
5. Confirm Removed : Used when a removed HDD is still listed. ALL DATA WILL BE LOST!

<Note> How to format current HDD?

HVR-04E doesn’t need additional format command. Just do it; ‘Remove’ → ‘Add’ → ‘Format’.

Appendix #2 Video Input

Video type / impedance setup switch

It's possible to set up Impedance of Video input line.

When one Video output is connected to several Input as below, the impedance of one input should be 75 ohm.

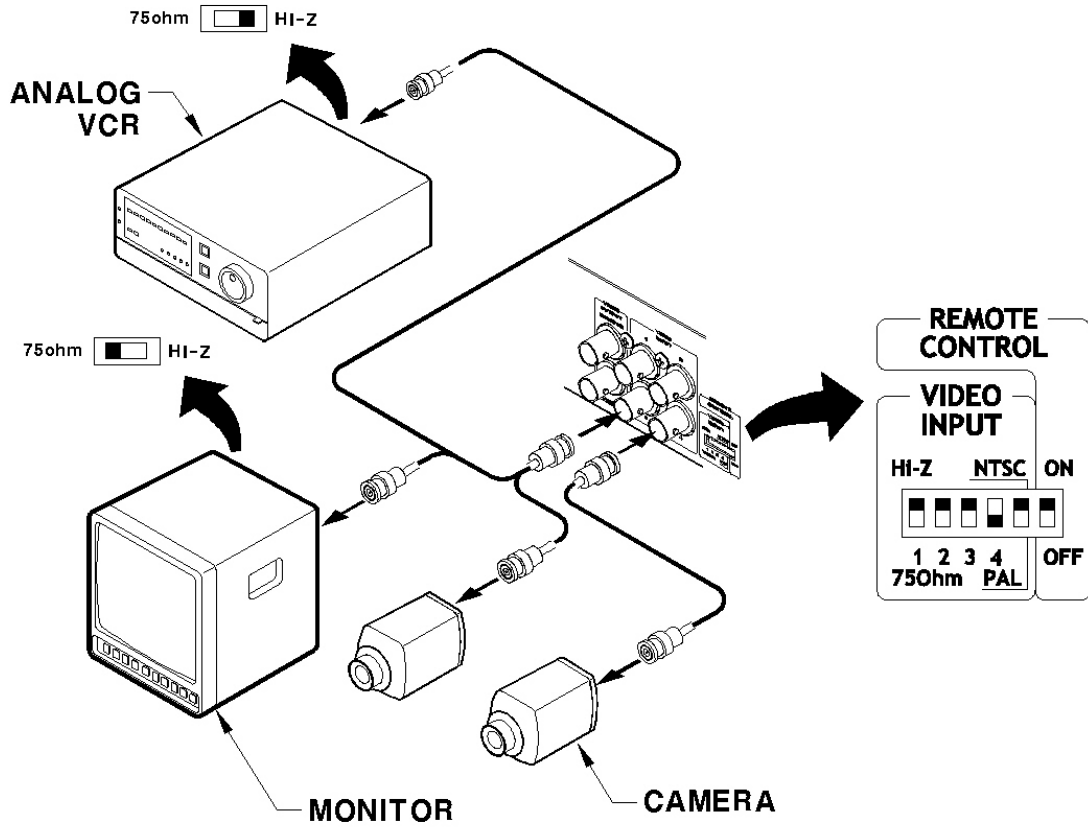

Appendix #3 Using CD-ROM

Components of CD- ROM disc

Installation Guide	:	HVR-04E Installation Guide
User's Guide	:	HVR-04E User's Guide
DVR Manager	:	DVR Manager User's Guide (HVR-04E Remote Management Program)
Acrobat Reader	:	Version 5.1

Preparation

To read manual of CD-ROM disc, Adobe Acrobat 5.0 should be installed in client's PC.

<Note>

If Adobe Acrobat Reader is not installed within client's PC, use the Acrobat Reader program of CD-ROM.

Reading manual of CD-ROM

Follow the steps to read user's guide.

1. Insert the supplied CD-ROM into CD-ROM drive of PC.
2. Open the user's guide, PDF file.

Appendix #4 Specification

General

CPU	32bit RISC Processor (200MIPS)
Flash Memory	8MB
Main Memory	64MB
OS	Embedded LINUX
Video Channel	4 Analog Channel & 12 IP Video Channel (NTSC or PAL)
Storage Device	Internal 3.5" IDE HDD 2EA (default 1EA) External 3EA for IEEE1394 Interface Support Max. 4Tbytes
Intelligent File System	Data-loss protection against power failure

Image Compression

Technology	Differential Wavelet
Average File Size	1~5KB (Standard Quality)
Image Quality Level	5 Level
Image Compression Rate	20:1~500:1
Recording Speed	Max. 120ips in total at NTSC (Analog Ch 60ips + IP Video Ch 60ips)

Network

Browser	DVR Manager
Protocol	TCP/IP, ARP, ICMP, DHCP, PPPoE
Connector	10/100Mbps Ethernet (RJ-45)
S/W Upgrade	Firmware upgrade via Network
Simultaneous Users	Monitoring : Max. 5 Users Playback : Max. 5 Users
Security	Password (User or Administrator Authentication) Watermarking (Against image forging)

Display

Monitoring	Max. 120ips (Analog Video 60ips) (IP Video 60ips)
Viewer	1ch, 4ch, 9ch, 13ch, 16ch, Auto Sequential
Playback Performance	Max. 60ips
Playback Speed	1x, 2x, 4x, 8x, 16x (Forward & Reverse Play)
Function	Step-Forward, Step-Reverse

Environment

Operation Temperature	5~45 C°
Storage Temperature	-10~55 C°
Operation Humidity	30~80%, free of condensation
Storage Humidity	93% below, free of condensation

Data Backup/Expansion/Copy

HDD Expandable Data Backup	IEEE1394
Analogue VCR	VHS Video output for VCR
Backup Reminder	Daily / Weekly / Monthly
Data Copy	USB Flash memory disk

Input/Output

Video	1 Monitor output via BNC 1 Video output via BNC
Audio	1 Input : Line-in, 1 Vpp 1 Output : Line-out, 1Vpp Level : -7~8(16 Step) Recording level AMP : 20dB amplifier for low level audio Monitoring : Local and remote
Digital Output	4 Relay outputs (Max DC 30W, AC 62.5VA)
Digital Output Schedule	Daily : Day / Night Weekly : Weekdays / Weekends Conditions : MD, Sensor inputs
Sensor Input	4 Sensor inputs (Support Dry contact)

PTZ Control

Serial Port	RS232(1), RS485(1), RS422(1)
Control Method (Local)	Front panel button & IR remote controller (control IP video channel as well)
Control Method (Remote)	On-the-screen PTZ control on PC
Preset Mode	8 points preset per channel
Group Mode	1 group per channel

Others

Digital Zoom	2x (Live & PlayBack Mode)
Alarm Trigger	Motion Detection or Sensor input
Alarm Data Preservation	Alarm triggered Video Data Preservation
Alarm Log	Log search Log monitoring via OSD & Network
Pre/Post Alarm	Pre : 1~10 seconds Post : 1~60 seconds
Schedule Recording	Daily : Day / Night Weekly : Weekdays / Weekends Conditions : Normal / Event
Text Data Recording	POS/ATM transaction information archived along with corresponding video data

Electricity

Power (Applied Adaptor)	DC 12V
Consumption Current	Max 4.5A (Internal 2 HDD) Typical 2.9A (Internal 2 HDD)
Consumption Voltage	Max. 54W Typical 35W

Mechanical

Dimension (W x D x H) 306 x 280 x 67(mm)
Weight 3.5Kg (With one HDD)

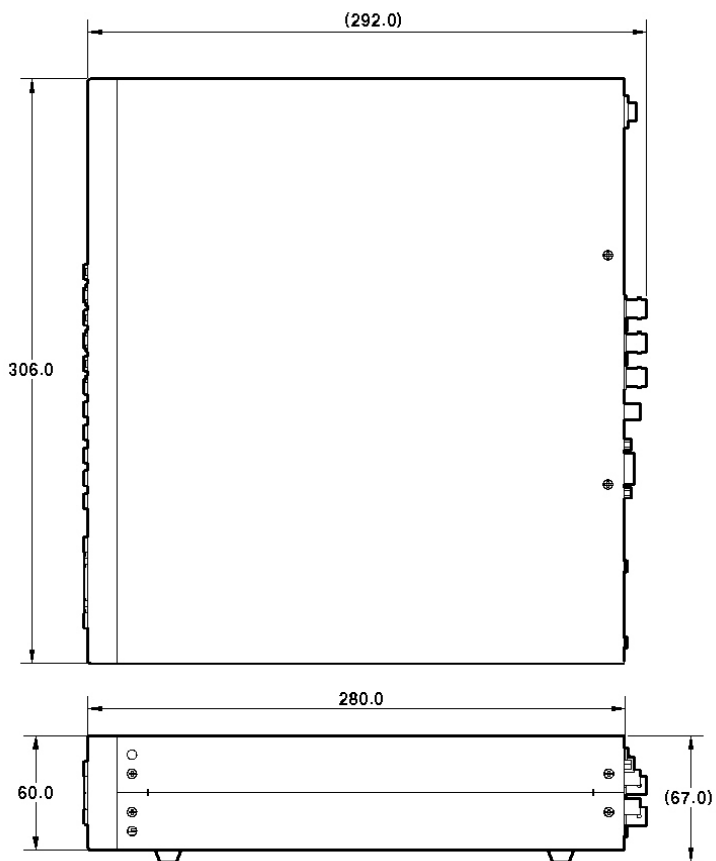



Hunt Electronic USA, Inc.

978 West 10th Street

Azusa, California 91702

Tel : (626) 812-8868

Fax : (626) 812-8828

Technical Support: 1-888-993-4868

URL: www.huntcctv.com

E-mail: info@huntcctv.com