

Garden Lantern

Model 92508

INSTALLATION AND OPERATING INSTRUCTIONS



**One
Stop
GARDENS**



3491 Mission Oaks Blvd., Camarillo, CA 93011
Visit our Web site at <http://www.harborfreight.com>

⚠ DANGER



**TO HELP PREVENT SERIOUS INJURY AND ELECTROCUTION,
READ AND UNDERSTAND ALL WARNINGS AND
INSTRUCTIONS BEFORE INSTALLATION OR USE.**

Copyright© 2005 by Harbor Freight Tools®. All rights reserved. No portion of this manual or any artwork contained herein may be reproduced in any shape or form without the express written consent of Harbor Freight Tools.

For technical questions and replacement parts, please call 1-800-444-3353.

PRODUCT SPECIFICATIONS



Electrical Requirements	120 VAC, 60 Hz
Light Bulb Maximum Wattage	100 (Type A ONLY)
Weight	4 lbs.
Approximate* Sensor Range	up to 19' and 180°
* External factors, such as obstructions and dirt on the sensor, can greatly limit the sensor's effective range.	
Light Timer Settings	1-5 minutes

SAVE THIS MANUAL

You will need this manual for the safety warnings and precautions, assembly, operating, inspection, maintenance and cleaning procedures, parts list and assembly diagram. Keep your invoice with this manual. Write the invoice number on the inside of the front cover. Keep this manual and invoice in a safe and dry place for future reference.

GENERAL SAFETY RULES



READ AND UNDERSTAND ALL INSTRUCTIONS
Failure to follow all instructions listed below may result in
electric shock, fire, and/or serious injury.
SAVE THESE INSTRUCTIONS

WORK AREA

1. **Keep your work area clean and well lit.** Cluttered benches and dark areas invite accidents. Make sure there is adequate surrounding workspace.
2. **Do not operate lights in explosive atmospheres, such as in the presence of flammable liquids, gases, or dust.** Light switches create sparks which may ignite the dust or fumes.
3. **Keep bystanders, children, and visitors away during installation.** Protect others in the work area from debris such as chips and sparks. Provide barriers or shields as needed.

ELECTRICAL SAFETY

4. **This light must be installed into an outlet box properly installed and grounded in accordance with all codes and ordinances. Check with a qualified electrician if you are in doubt as to whether the outlet is properly grounded.** If the light should electrically malfunction or break down, grounding provides a low resistance path to carry electricity away from the user.
5. **During installation, avoid body contact with grounded surfaces such as pipes, radiators, ranges, and refrigerators.** There is an increased risk of electric shock if your body is grounded.
6. **Do not expose open power outlets or wires to rain or wet conditions.** Work only on a dry day with no chance of rain, and **finish all work and seal the Base (1) of the lantern BEFORE leaving the work area.**
7. **Do not abuse the power lines. Never use the power lines to hold the lantern during installation. Keep the power lines away from heat, oil, sharp edges, or moving parts. Replace damaged power lines immediately.** Damaged power lines increase the risk of electric shock.
8. **Always disconnect the electrical circuit before performing any installation, internal inspection, or maintenance procedures.**
9. **Use the plastic hook on the Mounting Bracket (8) or other practical ways to secure and support the lantern to the outlet during installation.** Holding the lantern by hand or allowing the lantern to hang on the wires is dangerous and may damage the wiring, leading to electric shock or fire.

PERSONAL SAFETY



10. **Stay alert. Watch what you are doing, and use common sense during installation. Do not attempt to install this item while tired or under the influence of drugs, alcohol, or medication.** A moment of inattention during installation may result in serious personal injury.
11. **Dress properly. Do not wear loose clothing or jewelry. Contain long hair. Keep your hair, clothing, and gloves away from moving parts.** Loose clothes, jewelry, or long hair can be caught in moving parts during installation.
12. **Do not overreach. Keep proper footing and balance at all times.** Proper footing and balance enables better control of any power tools used during installation, if an unexpected situation arises.
13. **Use safety equipment. Always wear eye protection.** Dust mask, nonskid safety shoes, hard hat, or hearing protection must be used for appropriate conditions. Always wear ANSI approved safety goggles when installing using tools and/or equipment.
14. **Do not use the light if the Power Switch does not turn it on or off.** Any light that cannot be controlled with the Power Switch is dangerous and must be replaced.

15. **Maintain light with care. Keep lantern clean.** Properly maintained lights will work better and more efficiently. Do not use a damaged lantern. Tag damaged lanterns and their corresponding switches “Do not use” until repaired.
16. **Check for loose mounting, breakage of parts, and any other condition that may affect the lantern’s operation. If damaged, have the lantern serviced before use.** Many accidents are caused by poorly maintained fixtures.

SERVICE

17. **Fixture service must be performed only by qualified repair personnel.** Service or maintenance performed by unqualified personnel could result in a risk of injury.
18. **When servicing a fixture, use only identical replacement parts. Follow instructions in the “Maintenance Instructions” section of this manual.** Use of unauthorized parts or failure to follow maintenance instructions may create a risk of electric shock or injury.
19. **Maintain labels and nameplates on the Lantern.** These carry important information. If unreadable or missing, contact Harbor Freight Tools for a replacement.
20. **Only install type A bulbs rated at or below the maximum wattage (100 Watts) for this Lantern.**
21. **Do not open the black box inside the Base (1).** There are no user-serviceable parts inside.

SYMBOLOLOGY

	Double Insulated
	Canadian Standards Association
	Underwriters Laboratories, Inc.
V ~	Volts Alternating Current
A	Amperes
n_o <u>xxxx</u> /min.	No Load Revolutions per Minute (RPM)

UNPACKING

When unpacking, check to make sure all the parts shown on the **Parts List on the last page** are included. If any parts are missing or broken, please call Harbor Freight Tools at the number shown on the cover of this manual as soon as possible.

ASSEMBLY INSTRUCTIONS

NOTE: For additional information regarding the parts listed in the following pages, refer to the Assembly Diagram on the last page.

DANGER



The power to the outlet box must be disconnected before attempting to install this item.

If the power is left connected during installation, or if the power comes on accidentally, **SEVERE PERSONAL INJURY or DEATH** can occur.

- BEFORE STARTING THE INSTALLATION MAKE CERTAIN THAT:**
 - All needed tools and materials are present at the work area. Weather-proof sealant is not included.
 - Sufficient time is allotted for completing the installation.
 - It is a dry day with no chance of rain. Leaving the work area without finishing the installation creates a dangerous situation, and should be avoided at all costs.
- This device is installed on an electrical circuit that has sufficient voltage to SERIOUSLY INJURE or KILL you. If any doubt exists about your capability to install this unit safely and properly, this unit should be installed by a licensed electrician.**
- Select an appropriate switch-controlled outlet box for installation. Having a switch-controlled outlet allows quick disconnection in the event of an emergency. The lantern's mounting location:
 - Should be unblocked for optimal illumination and sensor range.
 - Must not block or interfere with any walkways.
 - Must be out of children's reach.
- Disconnect all power connected to the outlet box that this item is to be installed on. Visibly label the power switch leading to the circuit, "Work in progress on this circuit, DO NOT TURN POWER ON."**
- Remove the cover from the outlet box. Use a multimeter, set to a setting appropriate for testing 120 VAC, to determine that the power to the outlet is truly disconnected.
- Parts 1-7 and 10 are typically preassembled. Remove the Mounting Bracket (8) if it is attached to the Base (1). Both Bracket Screws (9) should remain threaded into the Bracket - see below.
- Using an Outlet Box Screw (12) through each slot in the Mounting Bracket (8), solidly attach it to the outlet box.

Figure 1

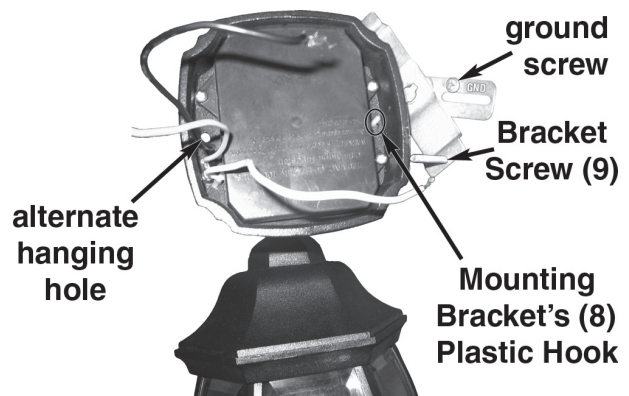

8. While being careful not to scrape either the wall or the lantern, hang the Base (1) of the lantern on the plastic hook on the Mounting Bracket (10) by the hole in the side of the Base - see **Figure 1** on the previous page.
9. The included Wire Nuts (11) may not be suitable for all applications; ALWAYS make sure that all connections are secure and, if a wire nut will not tighten properly, supply one of appropriate size.

Using the wire nuts, *carefully* attach the wires in the lantern to the power supply lines. For each connection, twist the nuts over both wires clockwise until both wires are secure. **NOTE: If any difference from these directions is noted in the color/type of supply lines, have a licensed electrician finish the installation.** Secure the wires in the order explained below:

- A. Attach the Black (hot) line to the Black wire.
- B. Attach the White (neutral) line to the white wire.
- C. *If a Green (ground) line is present, attach it to the yellow-green wire.*

*If a Green (ground) line is not present and the outlet box is a **grounded metal outlet box**, then attach the yellow-green wire to the **GND** screw on the Mounting Bracket (8) - see **Figure 1**, previous page.*

If a Green (ground) line is not present and the outlet box is not grounded, contact a licensed electrician.

Make sure that all connections are secure and that there is no metal showing on either the Black (hot) or White (neutral) connection before proceeding - see **Figure 2**, above right, for an example of a proper wire nut connection.

Figure 2

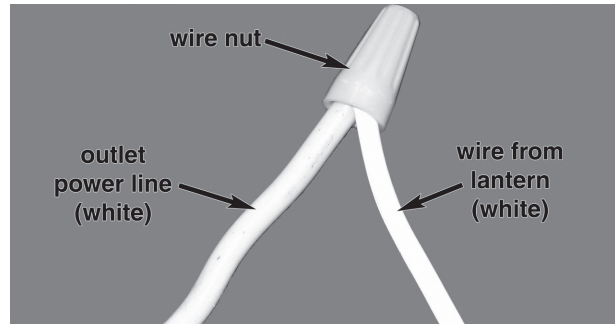

10. Turn the front part of the Mounting Bracket (8) until the Bracket Screws (9) are horizontal.
11. Carefully, so as not to pinch any wires or pull on any connections, slide the Base (1) off of the plastic hook and onto the Bracket Screws (9) so that the end of both Bracket Screws are visible at the front of the Base.
12. Thread the Acorn Nuts (10) onto the ends of the Bracket Screws (9) and tighten just enough to hold the Base (1).
13. Gently rotate the Base until the lantern is vertical. A level can be used to ensure that the lantern is level.
14. Securely tighten the Acorn Nuts (10).
15. Apply weatherproof sealant (not included) around the top half of the base where it meets the wall.

DO NOT APPLY SEALANT TO THE BOTTOM OF THE BASE.

The opening at the bottom allows moisture to drain out and helps prevent moisture from accumulating inside.

16. Install a type A light bulb rated at 100 watts or less, following the instructions outlined in number three of the **Maintenance Instructions**.

OPERATION INSTRUCTIONS

Refer to Figure 3 on the right for the location of the different settings.

TIME Setting

This controls the amount of time that the light stays on when the sensor is tripped.

Turn the dial clockwise for more time (up to 5 minutes) and counterclockwise for less time (down to one minute).

MODE Settings

TEST

This mode leaves the lantern on constantly and illuminates the red light on the control panel if the unit detects motion. This setting is helpful for adjusting the sensitivity.

PHOTO

This mode switches the lantern on when darkness falls.

SECURITY

This mode illuminates the lantern for the duration set by the TIME setting whenever the sensor detects motion.

Figure 3

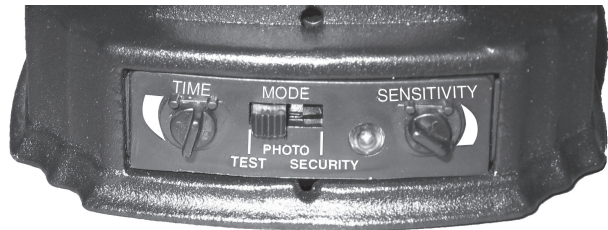

View from underneath the Base (1).

SENSITIVITY Setting

This controls the amount of motion needed to trip the sensor and the distance that the sensor detects motion at. **Keep in mind that the motion sensor's range is approximate and many different factors can affect the range that this unit detects motion at.**

Turn the dial clockwise to increase the sensitivity and counterclockwise to make the unit less sensitive.

MAINTENANCE INSTRUCTIONS

Shut the unit off at the wall switch before performing any maintenance, or inspection procedures, or before changing the light bulb.

1. **Inspect the unit periodically.** Check for loose mounting, breakage of parts, and any other condition that may affect the lantern's operation. If damaged, have the lantern serviced before use. Many accidents are caused by poorly maintained fixtures.
2. Weekly, wipe the lantern and sensor off with a damp cloth.
3. **To Change The Bulb:**
 - A. Shut off the switch and wait until the lantern has cooled off.
 - B. Remove the Hood Nut (4) and the Hood (3).
 - C. Loosen and remove both Nuts (7).
 - D. Remove both Washers (6) and the Hood Bracket (5).
 - E. Using protective gloves, remove the old bulb and install a new type A bulb of 100 watts or less.
 - F. Reassemble the lantern securely.

PARTS LIST

Part	Description	Q'ty
1	Base	1
2	Window	6
3	Hood	1
4	Hood Nut	1
5	Hood Bracket	1
6	Washer	2

Part	Description	Q'ty
7	Nut	2
8	Mounting Bracket	1
9	Bracket Screw	2
10	Acorn Nut	2
11	Wire Nut	3
12	Outlet Box Screw	1

ASSEMBLY DIAGRAM

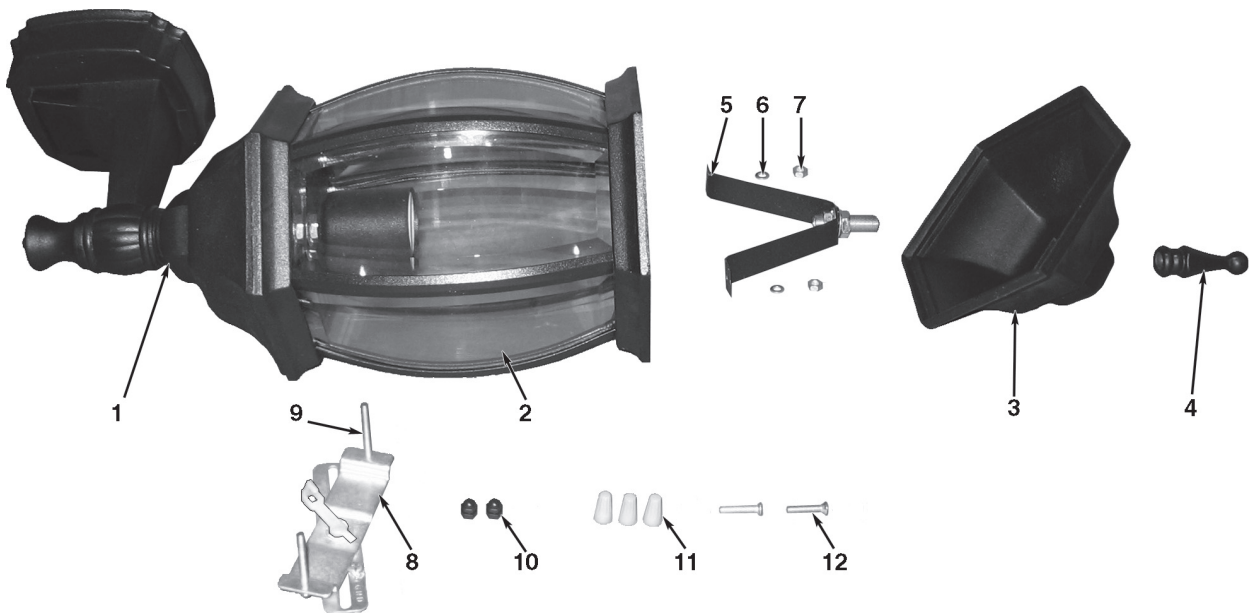

NOTE: Some parts are listed and shown for illustration purposes only, and are not available individually as replacement parts.

PLEASE READ THE FOLLOWING CAREFULLY

THE MANUFACTURER AND/OR DISTRIBUTOR HAS PROVIDED THE PARTS LIST AND ASSEMBLY DIAGRAM IN THIS MANUAL AS A REFERENCE TOOL ONLY. NEITHER THE MANUFACTURER OR DISTRIBUTOR MAKES ANY REPRESENTATION OR WARRANTY OF ANY KIND TO THE BUYER THAT HE OR SHE IS QUALIFIED TO MAKE ANY REPAIRS TO THE PRODUCT, OR THAT HE OR SHE IS QUALIFIED TO REPLACE ANY PARTS OF THE PRODUCT. IN FACT, THE MANUFACTURER AND/OR DISTRIBUTOR EXPRESSLY STATES THAT ALL REPAIRS AND PARTS REPLACEMENTS SHOULD BE UNDERTAKEN BY CERTIFIED AND LICENSED TECHNICIANS, AND NOT BY THE BUYER. THE BUYER ASSUMES ALL RISK AND LIABILITY ARISING OUT OF HIS OR HER REPAIRS TO THE ORIGINAL PRODUCT OR REPLACEMENT PARTS THERETO, OR ARISING OUT OF HIS OR HER INSTALLATION OF REPLACEMENT PARTS THERETO.