

	Preface
Chapter 1	General Introductions
Chapter 2	Getting Started
Chapter 3	Customizing this Notebook
Chapter 4	BIOS setup



Regulations Information

FCC-B Radio Frequency Interference Statement

This equipment has been tested and found to comply with the limits for a Class B digital device, pursuant to part 15 of the FCC rules. These limits are designed to provide reasonable protection against harmful interference in a residential installation. This equipment generates, uses and can radiate radio frequency energy and, if not installed and used in accordance with the instructions, may cause harmful interference to radio communications. However, there is no guarantee that interference will not occur in a particular installation. If this equipment does cause harmful interference to radio or television reception, which can be determined by turning the equipment off and on, the user is encouraged to try to correct the interference by one or more of the following measures:

- w Reorient or relocate the receiving antenna.
- w Increase the separation between the equipment and receiver.
- w Connect the equipment into an outlet on a circuit different from that to which the receiver is connected.
- w Consult the dealer or an experienced radio TV technician for help.

NOTE

1. *The changes or modifications not expressly approved by the party responsible for compliance could void the user's authority to operate the equipment.*
2. *Shield interface cables and AC power cord, if any must be used in order to comply with the emission limits.*

FCC Conditions

This device complies with part 15 of the FCC Rules. Operation is subject to the following two conditions:

1. This device may not cause harmful interference.
2. This device must accept any interference received, including interference that may cause undesired operation.



廢電池請回收

For better environmental protection, waste batteries should be collected separately for recycling or special disposal.

Safety Guideline for Using Lithium Battery

(Danish) ADVARSEL! Lithiumbatteri --- Eksplosionsfare ved fejlagtig håndtering. Udskiftning må kun ske med batteri af same fabrikat og type. Levé det brugte batteri tilbage til leverandøren.

(Deutsch) VORSICHT: Explosionsgefahr bei unsachgemäßem Austausch der Batterie. Ersatz nur durch denselben oder einen vom Hersteller empfohlenen gleich-wertigen Typ. Entsorgung gebrauchter Batterien nach Angaben des Herstellers.

(English) CAUTION: Danger of explosion if battery is incorrectly replaced. Replace only with the same or equivalent type recommended by the equipment manufacturer. Discard used batteries according to manufacturer's instructions.

(Finnish) VAROITUS: Paristo voi räjähtää, jos se on virheellisesti asennettu. Vaihda paristo ainoastaan valmistajan suosittelemaan tyyppiin. Hävitä käytetty paristo valmistajan ohjeiden mukaisesti.

(French) ATTENTION: Il y a danger d'explosion s'il y a remplacement incorrect de la batterie. Remplacer uniquement avec une batterie du meme type ou d'un type équivalent recommandé par le constructeur. Mettre au rebut les batteries usages conformément aux instructions du fabricant.

(Norwegian) ADVARSEL: Eksplosjonsfare ved feilaktig skifte av batteri. Benytt same batteritype eller en tilsvarende type anbefalt av apparatfabrikanten. Brukte batterier kasseres i henhold til fabrikantens instruksjoner.

(Swedish) VARNING: Explosionsfara vid felaktigt batteribyte. Använd samma batterityp eller en ekvivalent typ som rekommenderas av apparatillverkaren. Kassera använt batteri enligt fabrikantens instruction.

Caution on Using Modem

1. Never install telephone wiring during a lightning storm.
2. Never install telephone jacks in wet locations unless the jack is specifically designed for wet locations.
3. Never touch uninsulated telephone wires or terminals unless the telephone line has been disconnected at the network interface.
4. Use caution when installing or modifying telephone lines.
5. Avoid using the telephone function (other than a cordless type) during an electrical storm. There may be a remote risk of electric shock from lightning.
6. Do not use the telephone function to report a gas leak in the vicinity of the leak.

CD-ROM Drive Notice

CAUTION: This appliance contains a laser system and is classified as a “CLASS 1 LASER PRODUCT.” To use this model properly, read the instruction manual carefully and keep this manual for your future reference. In case of any trouble with this model, please contact your nearest “AUTHORIZED service station.” To prevent direct exposure to the laser beam, do not try to open the enclosure.

Wireless LAN Notice

EU (R&TTE)

European Union CE Marking and Compliance Notices

Products intended for sale within the European Union are marked with the Conformité Européene (CE) Marking, which indicates compliance with the applicable Directives and European standards and amendments identified below. This equipment also carries the Class 2 identifier.

Declaration of Conformity (MiniPCI Adapter)

Product Descriptions:

Intel® PRO/Wireless 2200BG Network Connection (model WM3B2200BG)

CE0336

Warning: See 802.11b and 802.11g restrictions for specific countries or regions within countries under the heading “European Economic Area Restrictions” below.

Translated Statements of Compliance

[English]

This product follows the provisions of the European Directive 1999/5/EC.

[Danish]

Dette produkt er i overensstemmelse med det europæiske direktiv 1999/5/EC

[Dutch]

Dit product is in navolging van de bepalingen van Europees Directief 1999/5/EC.

[Finnish]

Tämä tuote noudattaa EU-direktiivin 1999/5/EC määräyksiä.

[French]

Ce produit est conforme aux exigences de la Directive Européenne 1999/5/EC.

[German]

Dieses Produkt entspricht den Bestimmungen der Europäischen Richtlinie
1999/5/EC

[Greek]

Το προϊόν αυτό πληροί τις προβλέψεις της Ευρωπαϊκής Οδηγίας 1999/5/EC.

[Icelandic]

Þessi vara stenst reglugerð Evrópska Efnahags Bandalagsins númer 1999/5/EC

[Italian]

Questo prodotto è conforme alla Direttiva Europea 1999/5/EC.

[Norwegian]

Dette produktet er i henhold til bestemmelsene i det europeiske direktivet
1999/5/EC.

[Portuguese]

Este produto cumpre com as normas da Diretiva Européia 1999/5/EC.

[Spanish]

Este producto cumple con las normas del Directivo Europeo 1999/5/EC.

[Swedish]

Denna produkt har tillverkats i enlighet med EG-direktiv 1999/5/EC.

European Economic Area Restrictions

Local Restriction of 802.11b/802.11g Radio Usage

[Note to integrator: The following statements on local restrictions must be published in all end-user documentation provided with the system or product incorporating the Intel PRO/Wireless 2200BG Network Connection product.]

Caution: Due to the fact that the frequencies used by 802.11b/802.11g wireless LAN devices may not yet be harmonized in all countries, 802.11b/802.11g products are designed for use only in specific countries or regions, and are not allowed to be operated in countries or regions other than those of designated use. As a user of these products, you are responsible for ensuring that the products are used only in the countries or regions for which they were intended and for verifying that they are configured with the correct selection of frequency and channel for the country or region of use. Any deviation from permissible settings and restrictions in the country or region of use could be an infringement of local law and may be punished as such.

The European variant is intended for use throughout the European Economic Area. However, authorization for use is further restricted in particular countries or

regions within countries, as follows:

General

European standards dictate maximum radiated transmit power of 100 mW effective isotropic radiated power (EIRP) and the frequency range 2400 – 2483.5 MHz.

Belgium

The product may be used outdoors, but for outdoor transmissions over a distance of 300 m or more, a license from the BIPT is required.

This restriction should be indicated in the manual as follows:

Dans le cas d'une utilisation privée, à l'extérieur d'un bâtiment, au-dessus d'un espace public, aucun enregistrement n'est nécessaire pour une distance de moins de 300m. Pour une distance supérieure à 300m un enregistrement auprès de l'IBPT est requise. Pour une utilisation publique à l'extérieur de bâtiments, une licence de l'IBPT est requise. Pour les enregistrements et licences, veuillez contacter l'IBPT.

France

For Metropolitan departments:

2.400 - 2.4835 GHz for indoor use.

2.400 -2.454 GHz (channels 1 to 7) for outdoor use.

For Guadeloupe, Martinique, St Pierre et Miquelon, Mayotte:

2.400 - 2.4835 GHz for indoor and outdoor use.

For Reunion, Guyane:

2.400 - 2.4835 GHz for indoor use.

2.420 - 2.4835 GHz for outdoor use (channels 5 to 13)

United States

USA and Canada Safety Requirements and Notices

The FCC with its action in ET Docket 93-62 has adopted a safety standard for human exposure to radio frequency (RF) electromagnetic energy emitted by FCC certified equipment. The Intel® PRO/Wireless 2200BG Network Connection products meet the Human Exposure limits found in OET Bulletin 65, 2001, and ANSI/IEEE C95.1, 1992. Proper operation of this radio according to the instructions found in this manual will result in exposure substantially below the FCC's recommended limits.

The following safety precautions should be observed:

Do not touch or move antenna while the unit is transmitting or receiving.

Do not hold any component containing the radio such that the antenna is very close or touching any exposed parts of the body, especially the face or eyes, while transmitting.

Do not operate the radio or attempt to transmit data unless the antenna is connected; if not, the radio may be damaged.

Use in specific environments:

The use of wireless devices in hazardous locations is limited by the constraints posed by the safety directors of such environments.

The use of wireless devices on airplanes is governed by the Federal Aviation Administration (FAA).

The use of wireless devices in hospitals is restricted to the limits set forth by each hospital.

Antenna use:

In order to comply with FCC RF exposure limits, low gain integrated antennas should be located at a minimum distance of 20 cm (8 inches) or more from the body of all persons.

Explosive Device Proximity Warning

Warning: Do not operate a portable transmitter (such as a wireless network device) near unshielded blasting caps or in an explosive environment unless the device has been modified to be qualified for such use.

Antenna Warning

Warning: To comply with the FCC and ANSI C95.1 RF exposure limits, it is recommended for Intel® PRO/Wireless Network Connections installed in a desktop or portable computer, that the antenna for this device be installed so as to provide a separation distance of at least 20 cm (8 inches) from all persons and that the antenna must not be co-located or operating in conjunction with any other antenna or radio transmitter. It is recommended that the user limit exposure time if the antenna is positioned closer than 20 cm (8 inches).

Use On Aircraft Caution

Caution: Regulations of the FCC and FAA prohibit airborne operation of

radio-frequency wireless devices because their signals could interfere with critical aircraft instruments.

Other Wireless Devices

Safety Notices for Other Devices in the Wireless Network: Refer to the documentation supplied with wireless Ethernet adapters or other devices in the wireless network.

USA Radio Frequency Interference Requirements

FCC Regulations Part 15 Declaration of Conformity (DoC)

Intel Corporation declares that the equipment described in this document is within the requirements of the Code of Federal Regulations listed below:

Title 47 Part 15, Subpart B, Class B for a digital device.

This declaration is based upon the compliance of the Intel PRO/Wireless 2200BG Network Connection to the above standards. Intel has determined that the models listed have been shown to comply with the applicable technical standards if no unauthorized change is made in the equipment and if the equipment is properly maintained and operated.

These units are identical to the units tested and found acceptable with the applicable standards. Records maintained by Intel continue to reflect that units being produced under this Declaration of Conformity, within the variation that can be expected due to quantity production and tested on a statistical basis, continue to comply with the applicable technical standards.

FCC Rules and Regulations - Part 15

This device uses, generates and radiates radio frequency energy. The radio frequency energy produced by this device is well below the maximum exposure allowed by the Federal Communications Commission (FCC).

- This device complies with the limits for a Class B digital device pursuant to Part 15 subpart C of the FCC Rules and Regulations. Operation is subject to the following two conditions:
- This device may not cause harmful interference.
- This device must accept any interference received, including interference that may cause undesired operation.

The FCC limits are designed to provide reasonable protection against harmful interference when the equipment is installed and used in accordance with the instruction manual and operated in a commercial environment. However, there is no guarantee that interference will not occur in a particular commercial installation, or if operated in a residential area.

If harmful interference with radio or television reception occurs when the device is turned on, the user must correct the situation at the user's own expense. The user is encouraged to try one or more of the following corrective measures:

- Re-orient or relocate the receiving antenna.
- Increase the separation between the equipment and receiver.
- Connect the equipment into an outlet on a circuit different from that on which the receiver is connected.

- Consult the dealer or an experienced radio/TV technician for help.

CAUTION: The Part 15 radio device operates on a non-interference basis with other devices operating at this frequency. Any changes or modification to said product not expressly approved by Intel could void the user's authority to operate this device.

Underwriters Laboratories Inc. (UL) Regulatory Warning

For use in (or with) UL-Listed personal computers or compatible.

Macrovision Notice

This product incorporates copyright protection technology that is protected by U.S. patents and other intellectual property rights. Use of this copyright protection technology must be authorized by Macrovision, and is intended for home and other limited viewing uses only unless otherwise authorized by Macrovision. Reverse engineering or disassembly is prohibited.

Safety Instructions

1. Read the safety instructions carefully and thoroughly.
2. Save this User Guide for possible use later.
3. Keep this equipment away from humidity and high temperature.
4. Lay this equipment on a stable surface before setting it up.
5. The openings on the enclosure are used for air convection and to prevent the equipment from overheating. Do not cover the openings.
6. Make sure that the power voltage is within its safety range and has been adjusted properly to the value of 100~240V before connecting the equipment to the power inlet.
7. Place the power cord in a way that people are unlikely to step on it. Do not place anything on the power cord.
8. Always unplug the power cord before inserting any add-on card or module.
9. All cautions and warnings on the equipment should be noted.
10. If any of the following situations arises, get the equipment checked by a service personnel:
 - w The power cord or plug is damaged.
 - w Liquid has penetrated into the equipment.
 - w The equipment has been exposed to moisture.
 - w The equipment has not worked well or you can not get it work according to User's Manual.
 - w The equipment was dropped and damaged.
 - w The equipment has obvious signs of breakage.

11. Never pour any liquid into the opening that could damage the equipment or cause an electrical shock.
12. Do not leave the equipment in an unconditioned environment with a storage temperature of 60°C (140°F) or above, which may damage the equipment.
13. To prevent explosion caused by improper battery replacement, use the same or equivalent type of battery recommended by the manufacturer only.

Trademarks

All trademarks are the properties of their respective owners.

- w Microsoft is a registered trademark of Microsoft Corporation. Windows®98/ME, 2000/XP are registered trademarks of Microsoft Corporation.
- w AMI® is a registered trademark of American Megatrends Inc.
- w PCMCIA and CardBus are registered trademarks of the Personal Notebook Memory Card International Association.

Release History

Version	Revision Note	Date
1.0	First Release	May 2005

Copyright Notice

The material in this guide is the intellectual property of MICRO-STAR INTERNATIONAL. We take every care in the preparation of this document, but no guarantee is given as to the correctness of its contents. Our products are under continual improvement and we reserve the right to make changes without notice.

Please note that the setting diagrams or values in this guide are FOR YOUR REFERENCE ONLY. The model you bought may be slightly different from the illustrations and descriptions in this guide. If you are not sure about these information, such as the Notebook specification and equipment, please ask your local vendor for help.

Technical Support

Visit the MSI website for FAQ, technical guide, driver and software updates, and other information: <http://www.msi.com.tw/>.

Contact our technical staff at: support@msi.com.tw.

Table of Content

Preface

Regulations Information	II
FCC-B Radio Frequency Interference Statement	II
FCC Conditions	III
Safety Guideline for Using Lithium Battery	IV
Caution on Using Modem	V
CD-ROM Drive Notice	V
Wireless LAN Notice.....	VI
EU (R&TTE).....	VI
United States	X
Macrovision Notice	XIV
Safety Instructions	XV
Trademarks	XVI
Release History	XVI
Copyright Notice	XVII
Technical Support.....	XVII

Introductions

How to Use This Manual	1-2
Unpacking	1-4

Getting Started

Specification	2-2
Product View	2-6
Top-open View	2-6
Front View	2-8
Right-side View	2-10
Left-side View	2-12
Rear View	2-14
Bottom View	2-15
Power Management	2-17
AC Adapter	2-17
Battery Pack	2-19
Using the Battery Pack	2-22
Basic Operations	2-24
Safety and Comfort Tips	2-24
Have a Good Work Habit	2-25
Knowing the Keyboard	2-26
Knowing the Touchpad	2-32
About Hard Disk Drive	2-36
Using the Optical Storage	2-37
Using the Video Function	2-40
Using the Audio Function	2-42

Customizing this Notebook

Connecting the External Devices	3-2
Connecting the Peripheral Devices	3-3
Connecting the Communication Devices.....	3-6
PC Card Installation.....	3-7
Installing the PC card	3-7
Removing the PC card	3-8
Safely Remove Hardware.....	3-9

BIOS Setup

About BIOS Setup.....	4-2
When to Use BIOS Setup	4-2
How to Run BIOS Setup.....	4-2
Control Keys	4-3
BIOS Setup Menu.....	4-4
Main menu	4-5
Advanced menu.....	4-7
Security menu.....	4-9
Boot menu.....	4-11
Exit menu	4-12

	Preface
Chapter 1	General Introductions
Chapter 2	Getting Started
Chapter 3	Customizing this Notebook
Chapter 4	BIOS setup



Congratulations on becoming a new user of this notebook, the finely designed notebook. This brand-new exquisite notebook will give you a delightful and professional experience in using notebook. We are proud to tell our users that this notebook is thoroughly tested and certified by our reputation for unsurpassed dependability and customer satisfaction.

How to Use This Manual

This User's Manual provides instructions and illustrations on how to operate this notebook. It is recommended to read this manual carefully before using this notebook.

Chapter 1, General Introductions, includes the descriptions of all the accessories of this notebook. It is recommended to check out that if you have all the accessories included when you open the packing box. If any item is damaged or missing, please contact the vendor where you purchased this notebook.

Chapter 2, Getting Started, provides the specification of this notebook, and introduces the function buttons, quick launch buttons, connectors, LEDs and externals of this notebook. Also, this chapter instructs the correct procedure of installing or uninstalling the battery pack, and the brief ideas on how to use this notebook.

Chapter 3, Customizing this Notebook, gives instructions not only in connecting the mouse, keyboard, webcam, printer, external monitor, IEEE 1394 devices, and communication devices, but also in installing and removing the PC card.

Chapter 4, BIOS setup, provides information on BIOS Setup program and allows you to configure the system for optimum use.

Unpacking

First, unpack the shipping carton and check all items carefully. If any item contained is damaged or missing, please contact your local dealer immediately. Also, keep the box and packing materials in case you need to ship the unit in the future.

The package should contain the following items:

- w Notebook PC
- w User's Manual or Quick Start Guide
- w Software CD containing the drivers and utilities
- w Recovery CD
- w High-capacity Li-ion battery pack
- w AC adapter and power cord
- w Phone cable/Phone jack (optional)
- w Notebook carry bag (optional)

These accessories listed above may change without notice.

	Preface
Chapter 1	General Introductions
Chapter 2	Getting Started
Chapter 3	Customizing this Notebook
Chapter 4	BIOS setup



Specification

Physical Characteristic	
Dimension	355mm(L) x 255mm(D) x 30mm(H)
Weight	2.7 kg
CPU	
Processor Type	uFCPGA (479 pin)
Support Processor	Intel® Pentium® M processor; Intel® Celeron® M processor
L1 Cache	64K
L2 Cache	2MB for Pentium® M; 1M for Celeron® M
FSB Speed	533MHz for Pentium® M; 400MHz for Celeron® M
Core Chips	
North Bridge	Intel® 915PM
South Bridge	Intel® ICH6-M
Memory	
Technology	DDR 333/400
Memory	DDR SO-DIMM X 2 slots 128/256/512MB DDR SDRAM
Maximum	1GB (512MB DDR SO-DIMM X 2)
Power	
AC Adapter	75W, 19 Volt
Battery Type I	8 cells (Li-Ion)(4400mAh)

Battery Type I Life	3.5 hrs for Battery Mark / Mobile Mark, 4.5hrs for Instant On media play
Battery Type I Life In Stand by Mode	S3, battery:7days S4,S5:32~34days
Storage	
HDD form factor	9.5mm(High)
IDE Controller	Ultra DMA ATA-100
Optical Device	CD-ROM/CD-RW/DVD-ROM/COMBO/ DVD dual
I/O Port	
Monitor(VGA)	15 pin Mini D-Sub x 1
USB	x 4 (USB version 2.0)
Headphone Out	x 1
Mic-in	x 1
Comsumer IR	x 1
TV-Out	x 1
RJ11	x 1
RJ45	x 1
IEEE1394	x 1
Communication Port	
56K Fax/MODEM MDC (AC'97)	I/F --- AC97 S/W Modem Controller --- AC 97 Embedded Wake on Ring --- Support on S1/S2/S3 PTT Approval --- Yes (FCC/CTR21/JATE)

LAN	PHY --- Realtek 8100 Wake on LAN --- Support on S3/S4/S5 state LAN Boot --- Yes Wfm 2.0 support
Wireless LAN	IEEE 802.11b/g / IEEE 802.11a/b/g
PCMCIA	
Controller	RICOH 5C593 MMC/SD/MS 3 in one card reader x1
Slot	Type II x 1
CardBus	Support
Display	
LCD Type	15.4" WXGA
Brightness	Brightness controlled by K/B hot-keys
Video	
Controller	nVidia NV43M
VRAM	128MB (Single die x4)
LCD	1280 x 800 WXGA
CRT Support	640x480, max. 32bit color 800x600, max. 32bit color 1024x768, max. 32bit color 1400x1050, max. 32bit color 1152 x 768, max 32bit color 1280 x 1024, max. 32bit color 1600 x 1200, max.32bit color

	1800 x 1440, max. 32bit color
Display Detect	System auto detect LCD or CRT: <ol style="list-style-type: none"> 1. Display to CRT - only if LCD lid is closed; 2. Display to LCD - only if no CRT detected; 3. Display can scan CRT & LCD simultaneously if both are detected and activate.
Audio	
Sound Controller	Embedded in S/B
Sound Codec chip	Realtek ALC655
Internal Speaker	2 Speakers with housing
SoundBlaster	SoundBlaster compatible (Not support DOS)
Sound Volume	Adjust by volume button, K/B hot-key & SW
Software & BIOS	
Support OS	Win XP Home and Professional edition (SP2)
USB Flash Boot	Yes, USB floppy boot up DOS only
BIOS	Fast Boot Support --- Yes (Win XP)
Others	
Kensington Lock Hole	x 1
Compliance	WHQL --- PC2001

Product Overview

This section provides you the description of basic aspects of your Notebook. It will help you to know more about the appearance of this Notebook before using it.

Top-open View

Press the Cover Latch to open the top cover (LCD Panel). The figure of top-open view and description showing below will lead you to browse the main operating area of your NOTEBOOK.

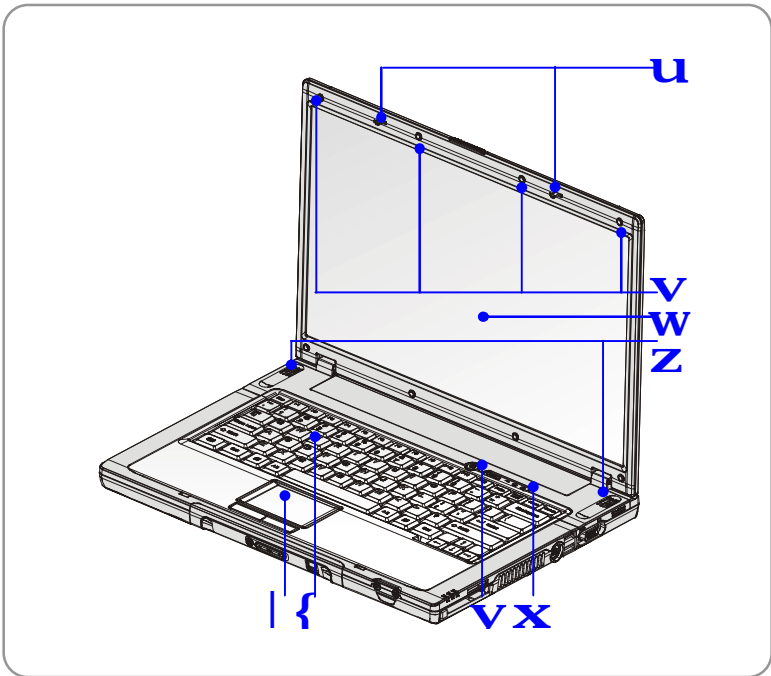

1. Cover Latch (Internal View)

It is a bounce-back device to lock the cover with the deck when closing your Notebook.



2. Rubber Pads

Protect your Notebook from random closing.



3. Display Panel

The 15.4-inch WXGA color LCD screen displays the output of the computer.

4. Status LED

	Num Lock: Glowing yellow when it is activated.
	Caps Lock: Glowing yellow when it is activated.
	AC Power On: Glowing yellow when AC power on.

5. Power Button and Quick Launch Button

	Power Button: Turn Notebook power ON and OFF.
	Wireless Button: Turn wireless function ON and OFF.

6. Stereo Speakers

Make high quality sound blaster with stereo system and Hi-Fi function supported.

7. Keyboard

The built-in keyboard provides all the functions of a full-sized 86-key (US-defined) keyboard.

8. Touchpad

It is the pointing device of the Notebook.

Front View

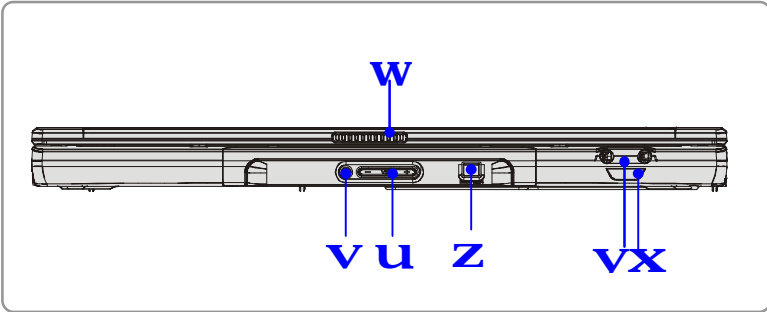

1. Volume Increase-Decrease Controller

Press “+” button to increase volume level and press “-” to decrease volume level.

2. Media Player Quick Launch Button

Press this button will open Media Player program to play music directly.

3. Cover Latch (External View)



Press Cover Latch rightward and lift the cover. The Cover Latch will bounce back when loosing it.

4. Consumer Infrared

It is used to transfer the Remote Controller signal to control the device.

5. Audio Port Connectors

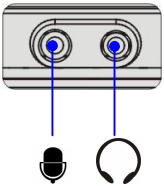
Make high quality sound blaster with stereo system and Hi-Fi function supported.

		Line In: Used for external CD player, tape recorder or other audio devices.
		Line Out: A connector for speakers or headphones.



6. IEEE 1394

The IEEE 1394 port is a high-speed bus that allows you to connect high-end digital devices such as the DV (digital video camera).

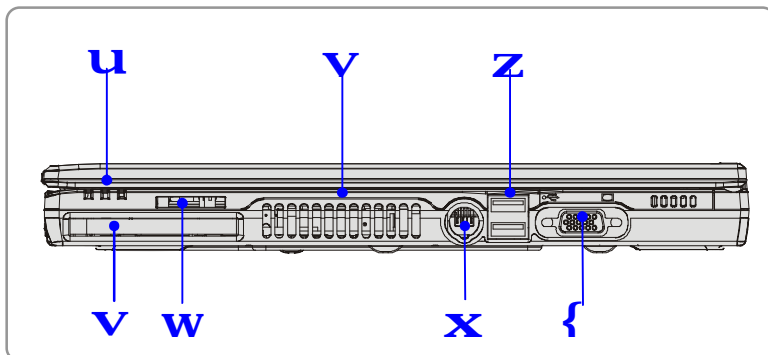
Right-side View



1. Status LED

	Wireless LAN (Green): ON – wireless LAN enabled; OFF – wireless LAN disabled.
	Power On/Off/Suspend (Blue): Blinking 0 system in suspend mode; ON – system fully on; OFF 0 system off.
	Battery Status (Green/Orange): ON (Green) 0 battery is charged fully; ON (Orange) – battery is charging; Blinking (Orange) – battery low or bad; OFF 0 the AC adapter is disconnected.

2. PC Card Slot

The computer provides a PC card slot to support one Type-II PC card for expansion functions, such as LAN/WLAN card, modem card, memory card, etc.

3. **3 in 1 Card Reader**

The built-in card reader supports MMC (multi-media card), SD (secure digital) and MS (memory stick) cards.

4. **S-Video Connector**

By using a Super VHS (S-Video) cable, this connector allows you to connect a television (NTSC/PAL system) to use as a computer display.

5. **Ventilator**

The ventilator is designed to cool the system. **DO NOT** block the ventilator for air circulation.

6. **USB Ports**

The USB 2.0 port allows you to connect USB-interface peripheral devices, such as the mouse, keyboard, modem, portable hard disk module, printer and more. The USB-standard interface supports “plug-and-play” technology, so that you can connect and remove the USB devices without turning off the computer.

7. **VGA Port**

The 15-pin-D-sub VGA port allows you to connect an external monitor or other standard VGA-compatible device (such as a projector) for a great view of the Notebook display.

Left-side View

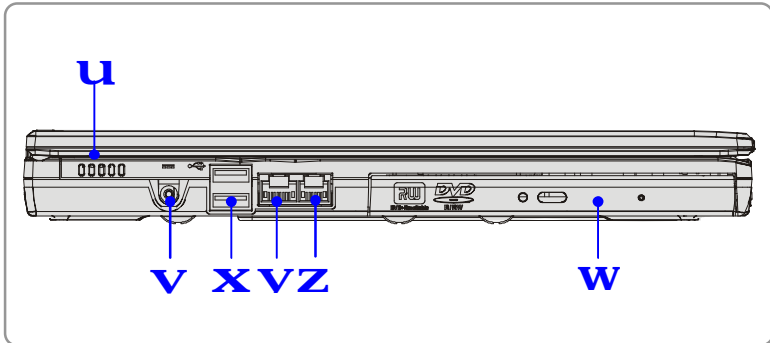

1. Stereo Speaker

Make high quality sound blaster with stereo system and Hi-Fi function supported.

2. Power Connector

To connect the AC adapter and supply power for the Notebook

3. Optical Storage Device

A slim CD-ROM/DVD-ROM/CD-RW/DVD Combo/DVD Dual drive is available in the Notebook, depending on the model you purchased. The optical device allows you to use the CD/DVD disc for installing software, accessing data and playing music/movie on the Notebook.

4. USB Port

The USB 2.0 port allows you to connect USB-interface peripheral devices, such as the mouse, keyboard, modem, portable hard disk module, printer and more. The USB-standard interface supports “plug-and-play” technology, so that you can connect and remove the

USB devices without turning off the computer.

5. RJ-45 Connector

The 100/10 Ethernet connector is used to connect a LAN cable for network connection.

6. RJ-11 Connector

The computer provides a built-in modem that allows you to connect an FJ-11 telephone line through this connector. With the 56K V.90 modem, you can make a dial-up connection.

Rear View

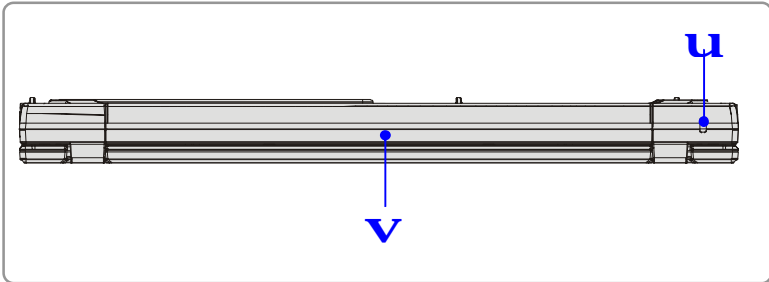

- 1. Kensington Lock Hole**

This is used to lock the Notebook to location for security

- 2. Battery Pack (Rear View)**

To supply power to your Notebook when the AC adapter is not connected

Bottom View

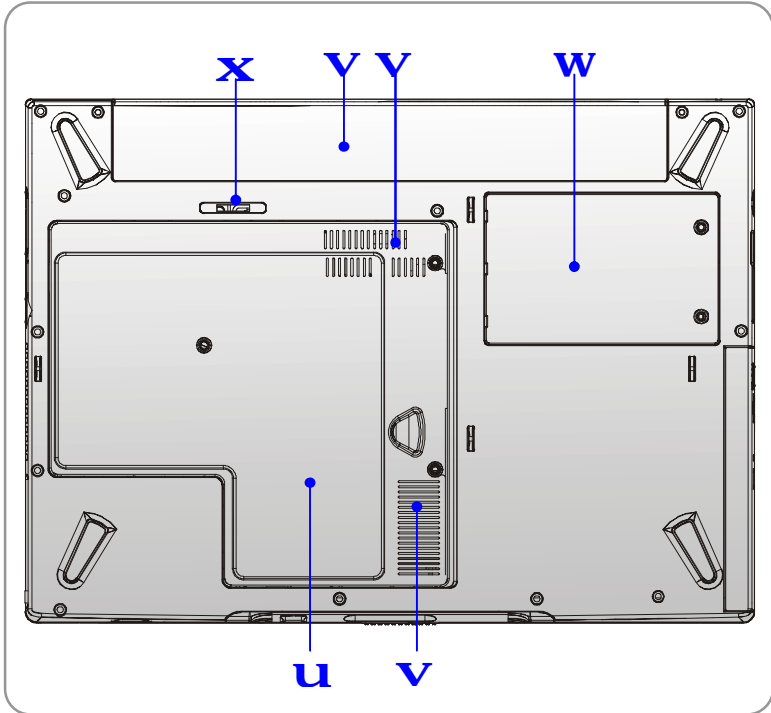

1. Mini PCI, Memory, CPU Compartment

The built-in wireless LAN card of the computer is installed in this compartment. This compartment also includes two SO-DIMM slots, also includes the Central Processor Unit. Please note that the memory installation/replacement must be done by an authorized retailer.

2. Battery Pack

Supply power to your computer when the AC adapter is not connected.

3. HDD Compartment

Inside this compartment is the Hard Drive.

4. Battery Release Button

It is a bounce-back device as a preparation for releasing the battery pack. Press it with one hand and pull the battery pack carefully with the other.

5. Ventilator

The ventilator is designed to cool the system. DO NOT block the ventilator for air circulation.

Power Management

AC Adapter

Please be noted that it is strongly recommended to connect the AC adapter and use the AC power while using this Notebook for the first time. When the AC adapter is connected, the battery is being charged immediately.

NOTE that the AC adapter included in the package is approved for your Notebook; using other adapter model may damage the Notebook or other devices on the Notebook.

Connecting the AC Power

1. Unpack the package to find the AC adapter and power cord.
2. Attach the power cord to the connector of the AC adapter (**u**).
3. Plug the DC end of the adapter to the Notebook (**v**), and the male end of the power cord to the electrical outlet (**w**).

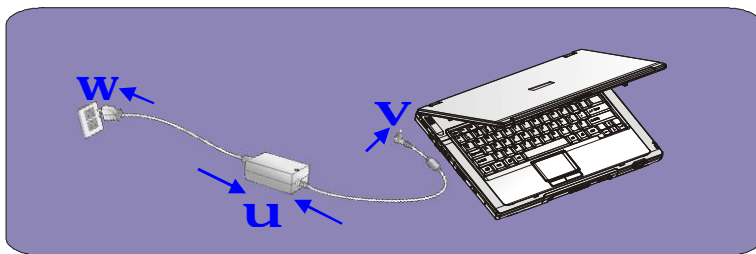

Disconnecting the AC Power

When you disconnect the AC adapter, you should:

1. Unplug the power cord from the electrical outlet first.
2. Unplug the connector from the Notebook.
3. Disconnect the power cord and the connector of AC adapter.
4. When unplugging the power cord, always hold the connector part of the cord. Never pull the cord directly!

Battery Pack

This Notebook is equipped with a high-capacity 8-cell Li-ion Battery pack.

The rechargeable Li-ion battery pack is an internal power source of the Notebook. A fully charged battery pack can supply power to the Notebook up to 4.5/5 hours (Using 8-cell battery). It depends on the way you use the Notebook.

Releasing the Battery Pack

It's a better way to have extra battery for enough power supply, so you don't have to worry about the lack of battery power. It's recommend to buy a battery pack from your local dealer.

To remove the battery pack:

1. Make sure the Notebook is turned off.
2. Check the Lock/Unlock button is in unlocked status.
3. Locate the Battery Release Button on the bottom side.
4. Push the Release Button to the direction of arrow showing below the button (**U**).
5. Slide the left side of the battery pack first out of the compartment and then pull the right side of the battery pack (**V**).

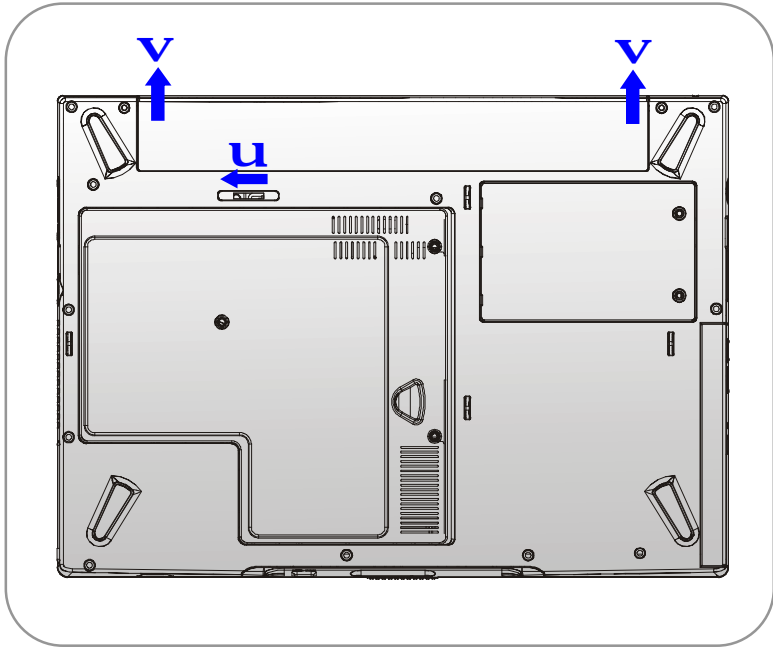

Replacing the Battery Pack

1. Insert the right side of battery pack into the compartment.
2. Slightly slide and press the battery pack into the right place. (**u**)
3. After the right side of the battery pack fitting the right track, then slightly press the left side of battery pack into the battery chamber.
4. Make sure the Lock/Unlock Button is in lock position. (**v**)

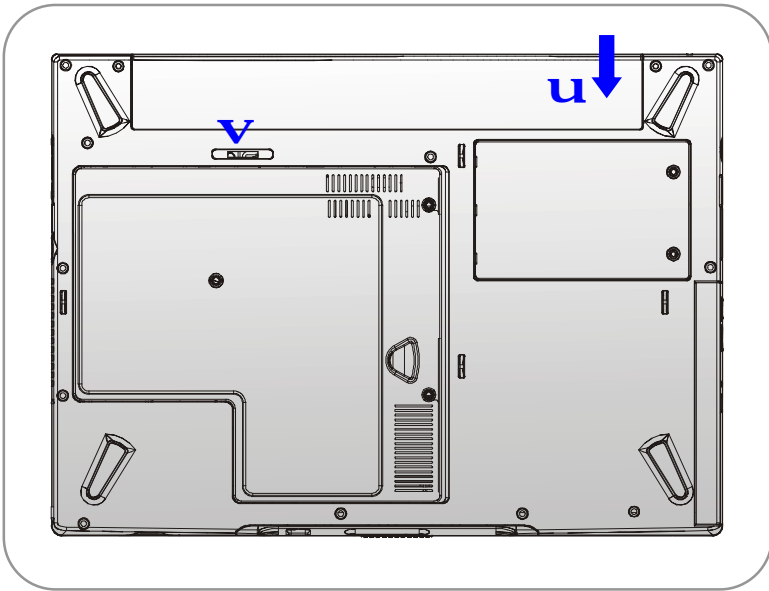

info

1. *Do not try to disassemble THE BATTERY PACK.*
2. *Please follow your local laws and regulations to recycle the unused battery pack.*

Using the Battery Pack

Battery Safety Tips

Replacing or handling the battery incorrectly may present a risk of fire or explosion, which could cause serious injury.

- w Only replace the main battery pack with the same or equivalent type of battery.
- w Do not disassemble, short-circuit or incinerate batteries or expose them to temperatures above +60° C (+140° F).
- w Do not temper with batteries. Keep them away from children.
- w Do not use rusty or damaged batteries.
- w Dispose of batteries according to local regulations. Check with your local solid waste officials for details about recycling options or for proper disposal in your area.

Conserving Battery Power

Efficient battery power is critical to maintain a normal operation. If the battery power is not managed well, the saved data and customized settings may be lost.

Follow these tips to help optimizing battery life and avoid a sudden power loss.

- w Suspend system operation if the system will be idle for a while or shorten the Suspend Timer's time period.
- w Turn off the system if you won't be using it for a period of time.
- w Disable unneeded settings or remove idle peripherals to conserve power.
- w Connect an AC adapter to the system whenever possible.

Charging the Battery Pack

The battery pack can be recharged while it is installed in the Notebook. Please pay attention to the following tips before recharging the battery:

- w If a charged battery pack is not available, save your work and close all running programs and shut down the system or Save-to-Disk.
- w Plug in an external AC/DC power source.
- w You can use the system, suspend system operation or shut down and turn off the system without interrupting the charging process.
- w The battery pack uses Lithium-ion battery cells that have no “memory effect.” You do not need to discharge the battery pack before you begin charging. However, to optimize the life of battery, we suggest that consuming the battery power completely once a month is necessary.
- w If you do not use the Notebook for a long time, it is suggested to remove the battery pack from your Notebook. This may be helpful to extend your battery life.
- w The actual charging time will be determined by the applications in use.

Basic Operations

If you are a beginner to the Notebook, please read the following tips to make yourself safe and comfortable during the operations.

Safety and Comfort Tips

The Notebook is a portable platform that allows you to work anywhere. However, choosing a good workspace is important if you have to work with your Notebook for long periods of time.

- w Your work area should have enough illumination.
- w Choose the proper desk and chair and adjust their height to fit your posture when operating.
- w When sitting on the chair and adjust the chair's back (if available) to support your back comfortably.
- w Place your feet flat and naturally on the floor, so that your knees and elbows have the proper position (about 90-degree) when operating.
- w Put your hands on the desk naturally to support your wrists.
- w Adjust the angle/position of the LCD panel, so that you can have the optimal view.
- w Avoid using your Notebook in the space where may cause your discomfort (such as on the bed).
- w The Notebook is an electrical device, please treat it with great care to avoid personal injury.

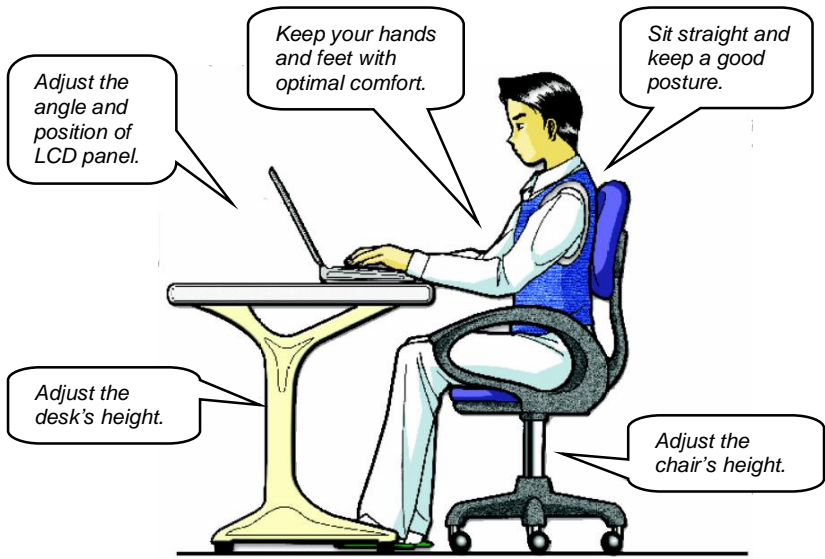

Have a Good Work Habit

Have a good work habit is important if you have to work with your Notebook for long periods of time; otherwise, it may cause discomfort or injury to you. Please keep the following tips in mind when operating.

- w Change your posture frequently.
- w Stretch and exercise you body regularly.
- w Remember to take breaks after working for a period of time.

Knowing the Keyboard

The Notebook's keyboard provides all the functions of a full-sized 86-key keyboard and an additional [Fn] key for specific functions on the Notebook.

The keyboard can be divided into four categories: **Typewriter keys**, **Cursor keys**, **Numeric keys**, and **Function keys**.

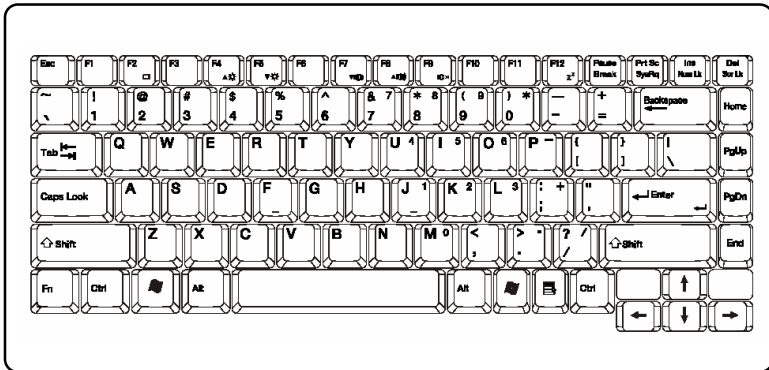

Typewriter Keys

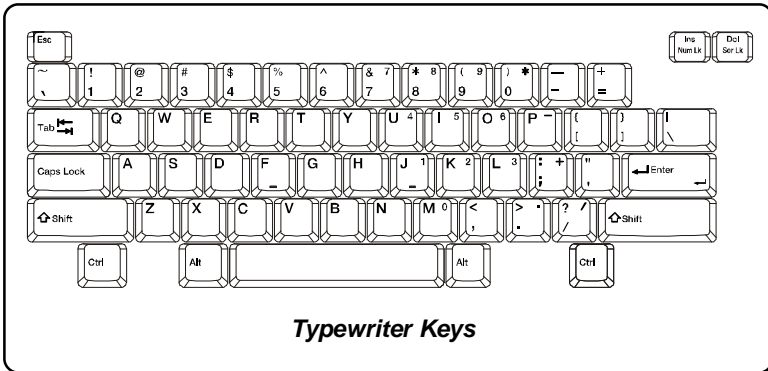

The function of these Typewriter keys is the major function of the keyboard, which is similar to the keys on a typewriter. It also provides several keys for special purposes, such as the [Ctrl], [Alt] and [Esc] key.





When the lock keys are pressed, the corresponding LEDs will light up to indicate their status:



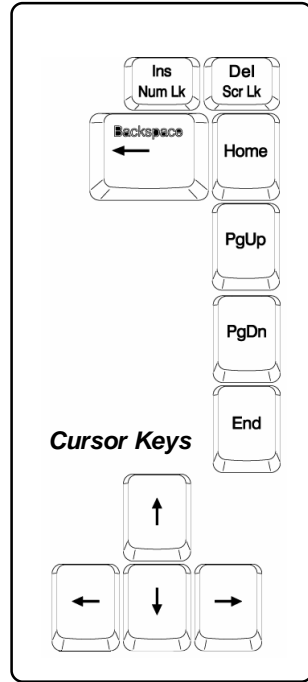

- n **Num Lock:** Press and hold the [Fn] key and press this key to toggle the Num Lock on and off. When this function is activated, you can use the numeric keys that are embedded in the typewriter keys.
- n **Caps Lock:** Press this key to toggle the Caps Lock on and off. When this function is activated, the letters you type are kept in uppercase.
- n **Scroll Lock:** Press and hold the [Fn] key and press this key to toggle the Scroll Lock on and off. This function is defined by individual programs, and it is usually used under DOS.

Cursor Keys



The keyboard provides four cursor (arrow) keys and **[Home]**, **[PgUp]**, **[PgDn]**, **[End]** keys at the lower right corner, which are used to control the cursor movement.



	Move the cursor left for one space.
	Move the cursor right for one space.
	Move the cursor up for one line.
	Move the cursor down for one line.

	Move to the previous page.
	Move to the next page.
	Move to the beginning of the line (or document).
	Move to the end of the line (or document).

The Backspace key, [**Ins**] and [**Del**] keys at upper right corner are use for editing purpose.

	This key is used to switch the typing mode between “insert” and “overtyping” modes.
	Press this key to delete one character to the right of the cursor and move the following text left for one space.
	Press this key to delete one character to the left of the cursor and move the following text left for one space.

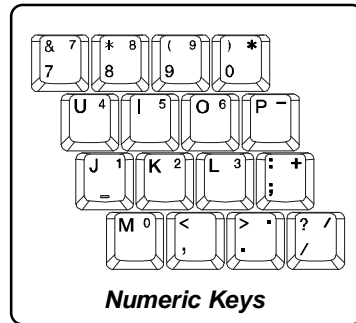

Numeric Keys

The keyboard provides a set of numeric keypad, which is embedded in the typewriter keys. When the Num Lock is activated, you can use these numeric keys to enter numbers and calculations.









Function Keys

n Windows Keys

You can find the Windows Logo key () and one Application Logo key () on the keyboard, which are used to perform Windows-specific functions, such as opening the Start menu and launching the shortcut menu. For more information of the two keys, please refer to your Windows manual or online help.

n [Fn] Key

 + 	Switch the display output mode between the LCD, external monitor and Both.
 + 	Increase the LCD brightness.
 + 	Decrease the LCD brightness.

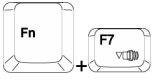
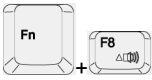
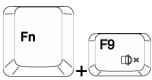
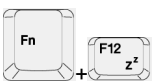
	Decrease the built-in speaker's volume.
	Increase the built-in speaker's volume.
	Disable the Notebook's audio function.
	Force the Notebook into suspend mode (depending on the system configuration).

Knowing the Touchpad

The touchpad integrated in your Notebook is a pointing device that is compatible with standard mouse, allowing you to control the Notebook by pointing the location of the cursor on the screen and making selection with its two buttons.

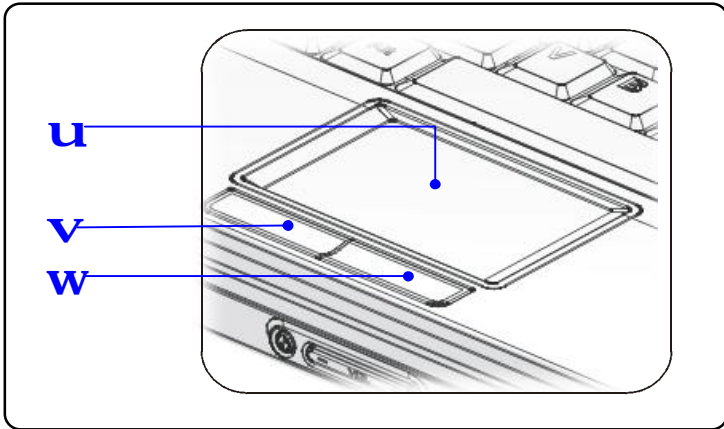

1. Cursor Movement Area

This pressure-sensitive area of the touchpad, allows you to place your finger on it and control the cursor on the screen by moving your finger.

2. Left Button

Acts as the mouse's right button.

3. Right Button

Acts as the mouse's left button.

Using the Touchpad

Read the following description to learn how to use the touchpad:

n Positioning and Moving

Place your finger on the touchpad (usually using the forefinger), and the rectangular pad will act as a miniature duplicate of your display. When you move your fingertip across the pad, the cursor on the screen will move simultaneously in the same direction. When your finger reaches the edge of the pad, lift your finger and replace it on a proper location of the touchpad.

n Point and Click

When you have moved and placed the cursor over an icon, a menu item or a command that you want to execute, simply tap slightly on the touchpad or press the left button to select. This procedure, called as point and click is the basics of operating your Notebook. Unlike the traditional pointing device such as the mouse, the whole touchpad can act as a left button, so that your each tap on the touchpad is equivalent to pressing the left button. Tapping twice more rapidly on the touchpad is to execute a double-click.

n Drag and Drop

You can move files or objects in your Notebook by using drag-and-drop. To do so, place the cursor on the desired item and slightly tap twice on the touchpad, and then keep your fingertip in contact with the touchpad on the second tap. Now, you can drag the selected item to the desired location by moving your finger on the touchpad, and then lift your finger from the touchpad to drop the item into place. Alternately, you can press and hold the left button when you select an item, and then move your finger to the

desired location; finally, release the left button to finish the drag-and-drop operation.

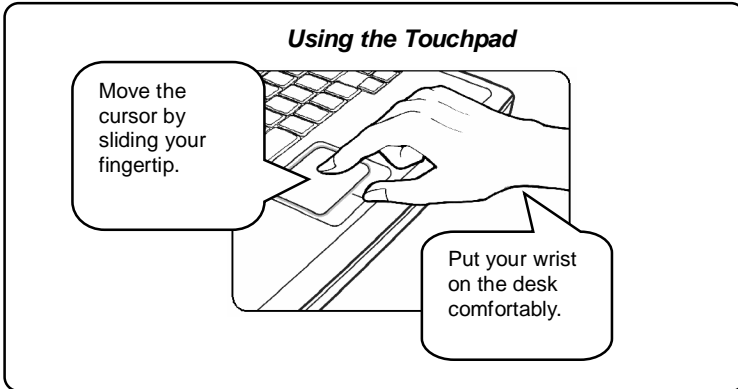

n **Configuring the Touchpad**

You can customize the pointing device to meet your personal needs. For example, if you are a left-hand user, you may want to swap the functions of the two buttons. In addition, you can change the size, shape, moving speed and other advanced features of the cursor on the screen.

To configure the touchpad, you can use the standard Microsoft or IBM PS/2 driver in your Windows operating system. The **Mouse Properties** in **Control Panel** allows you to change the configuration.

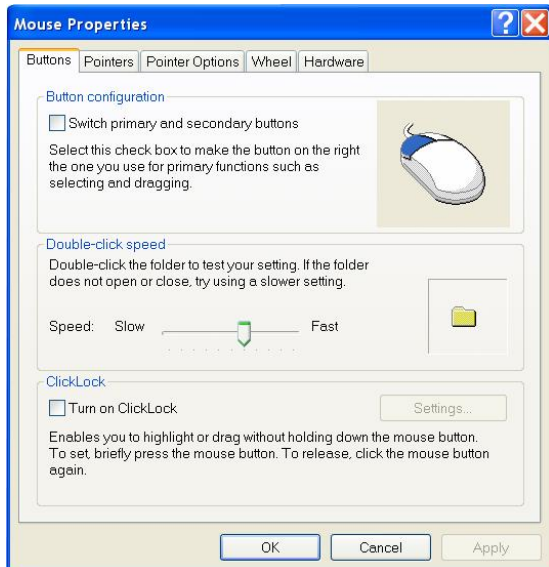

Mouse Properties Window

About Hard Disk Drive

Your Notebook is equipped with a 2.5-inch IDE (Integrated Drive Electronics) hard disk drive. The hard disk drive is a storage device with much higher speed and larger capacity than other storage devices, such as the floppy disk drive and optical storage devices. Therefore, it is usually used to install the operating system and software applications.



info

1. *To avoid unexpected data loss in your system, please backup your critical files regularly.*
2. *Do not turn off the Notebook when the Hard Disk In-use LED is on.*
3. *Do not remove or install the hard disk drive when the Notebook is turned on. The replacement of hard disk drive should be done by an authorized retailer or service representative.*

Using the Optical Storage

Your Notebook is equipped with an optical storage device, which is known as the CD/DVD-ROM, CD-RW, DVD Combo and DVD Dual drive. The actual device installed in your Notebook depends on the model you purchased.

- n **CD-ROM Drive:** Allows you to read CD disks, including audio CDs and CD-R/RW disks.
- n **DVD-ROM Drive:** Allows you to read DVD disks and CD disks, including movie DVDs, audio CDs and CD-R/RW disks.
- n **CD-RW Drive:** Allows you to create the CD-R/RW disks containing your own contents.
- n **DVD Combo Drive:** A cost-effective solution that can work both as a DVD-ROM drive and a CD-RW drive.
- n **DVD Dual Drive:** A dual format recorder, allows you to record both the -R/RW and +R/RW formats.



info

1. *The optical storage devices are classified as a Class 1 Laser products. Use of controls or adjustments or performance of procedures other than those specified here in may result in hazardous radiation exposure.*
2. *Do not touch the lens inside the drive.*

Inserting the CD

The following instruction describes the general procedure when operating the optical storage device, including the DVD-ROM drive.

1. Confirm that the Notebook is turned on.
2. Press the Eject Button on the drive's panel and the CD tray will slide out partially. Then, gently pull the tray out until fully extended.
3. Place your CD in the tray with its label facing up. Slightly press the center of the CD to secure it into place.
4. Push the tray back into the drive.

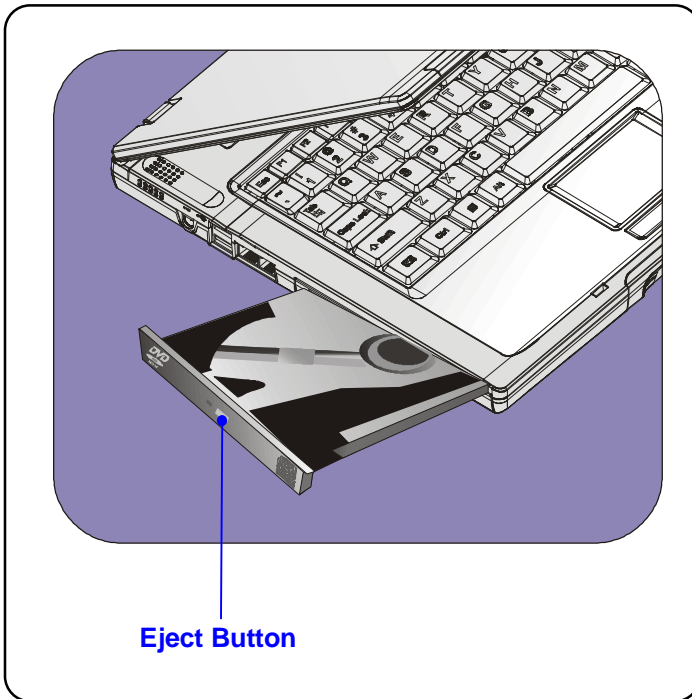

Removing the CD

1. Press the Eject Button on the drive's panel and the CD tray will slide out partially. Then, gently pull the tray out until fully extended.
2. Hold the CD by its edge with your fingers and lift it up from the tray.
3. Push the tray back into the drive.



info

1. *Confirm that the CD is placed correctly and securely in the tray before closing the tray.*
2. *Do not leave the CD tray open.*

Using the Video Function

Configuring the Display Settings

Your Notebook PC has been set to a default resolution and colors when shipping. Now, you can change the settings to meet your needs through the operating system..

n Changing the Resolution and Colors Quality

1. Click **Start** from the taskbar and select **Control Panel** to open the Control Panel window.
2. In the Control Panel, double-click the Display item to open the Display Properties window.
3. In the **Screen Resolution** field under the **Setting** Tab, move the slide bar to adjust the screen resolution; in the **Color Quality** field, select the desired colors setting from the pull-down menu..

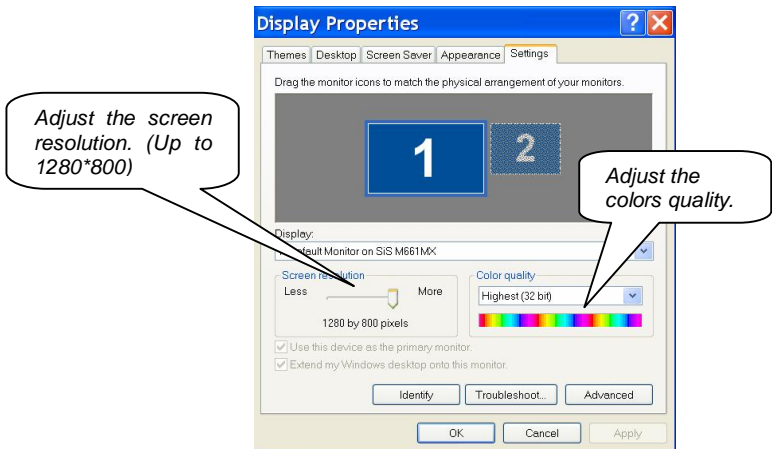

n Changing the Resolution and Colors Quality

1. Click **Start** from the taskbar and select **Control Panel** to open to Control Panel window.
2. Double-click the **Display** item to open the Display Properties window.
3. Go to **Settings** Tab and Click the **Advanced** button to bring up the following window that contains more settings.

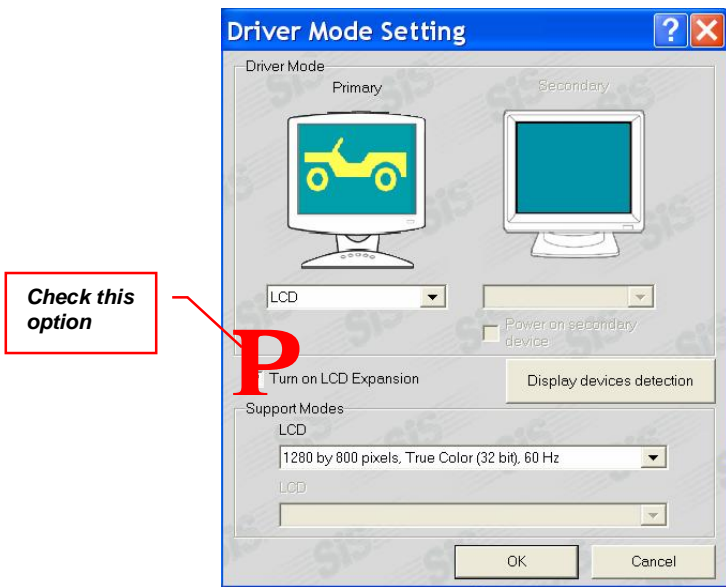

4. In Driver Mode Setting field under the Utility Manager tab, the default of Primary mode is LCD. If you have connected the extra display devices (CRT monitor and TV), the Secondary field will be available for setup.

Using the Audio Function

Connecting Audio Devices

Your Notebook PC is equipped with a audio subsystem. However, you can also connect the external audio devices for a better audio quality when enjoying your music and movie on the computer. The audio-out jack allows you to connect the speakers and headphones; the microphone jack allows you to connect the external microphone.

Volume Control

Double-click the **Volume Control** icon on the taskbar and the Master Volume dialog box will appear as shown below. You can move the slide bar to adjust the volume.

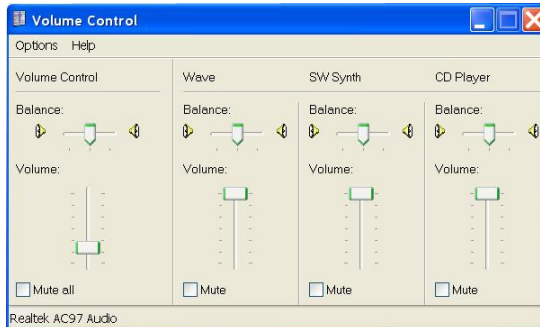

	Preface
Chapter 1	General Introductions
Chapter 2	Getting Started
Chapter 3	Customizing this Notebook
Chapter 4	BIOS setup



Connecting the External Devices

The I/O (input/output) ports on the Notebook allow you to connect peripheral devices.

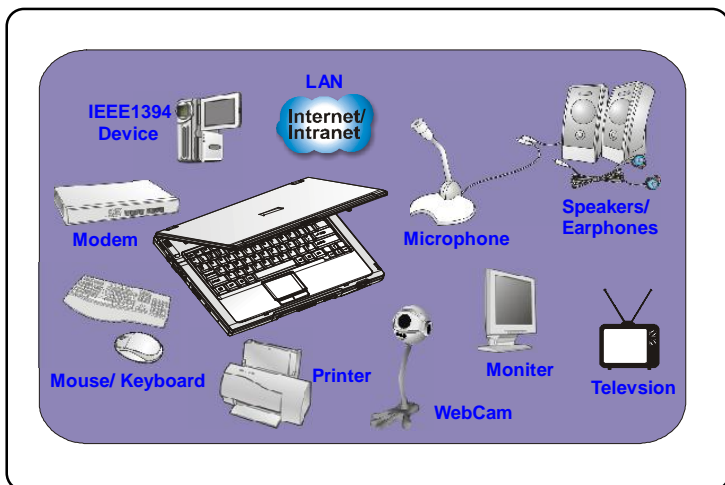

Connecting the Peripheral Devices

Connecting the Mouse

You can connect a mouse to your Notebook through the PS/2 port or USB port. If there is no PS/2 port available on your Notebook, but you only have mouse of PS2 connector, please purchase a PS/2-USB connector first. To connect the mouse:

1. Turn on the Notebook and install the mouse driver.
2. Connect your mouse to the Notebook.
3. The Notebook may auto detect your mouse driver and enable the mouse function. If there is no detection of you mouse you can manually enable the mouse by going to **Start Menu à Control Panel à Add Hardware** to add the new device.

Connecting the Keyboard

You can connect a keyboard to your Notebook through the PS/2 port or USB port. If there is no PS/2 port available on your Notebook, but you only have mouse of PS2 connector, please purchase a PS/2-USB connector first. To connect the keyboard:

1. Turn on the Notebook and install the keyboard driver.
2. Connect your keyboard to the Notebook.
3. The Notebook may auto detect your keyboard driver and enable the keyboard function. If there is no detection of you keyboard you can manually enable the keyboard by going to **Start Menu à Control Panel à Add Hardware** to add the new device.

Connecting the WebCam

You can connect a WebCam to your Notebook through the USB port. To connect the WebCam:

1. Turn on the Notebook and install the WebCam driver.
2. Connect your WebCam to the Notebook.
3. The Notebook may auto detect your WebCam driver and enable the WebCam function. If there is no detection of you WebCam you can manually enable the WebCam by going to **Start Menu à Control Panel à Add Hardware** to add the new device.

Connecting the Printer

If your printer has a USB interface, you can then use the USB port on the Notebook to connect the printer. The following instruction describes the general procedure to connect a printer:

1. Turn off the Notebook.
2. Connect one end of the printer cable to the Notebook's USB port and the other end to the printer.
3. Connect the power cord and turn on the printer.
4. Turn on the Notebook and the system will detect a new device. Install the required driver.

For further instructions, please refer to your printer's manual.

Connecting the External Monitor or TV

You can connect an external monitor to your Notebook through the VGA port for a larger view with higher resolution. To connect the monitor:

1. Make sure that the Notebook is turned off.

2. Plug the monitor's D-type connector into the Notebook's VGA port.
3. Connect the monitor's power cord and turn on the monitor.

Turn on the Notebook and the monitor should respond by default. If not, you can switch the display mode by pressing **[Fn]+[F2]**. Alternately, you can change the display mode by configuring the settings in **Display Properties** of Windows operating system.

Connecting the IEEE 1394

The IEEE 1394 port of your Notebook is a next-generation serial bus that features a high-speed transfer rate and the connection of up to 63 devices, allowing you to connect many high-end peripheral devices and consumer electronic appliances, such as the DV (digital video camera). The IEEE 1394 standard interface supports "**plug-and-play**" technology, so that you can connect and remove the IEEE 1394 devices without turning off the Notebook.

To connect the IEEE 1394 device, simply connect the cable of the device to the IEEE 1394 port of your Notebook.

Connecting the Communication Devices

Using the LAN

The RJ-45 connector of the Notebook allows you to connect the LAN (local area network) devices, such as a hub, switch and gateway, to build a network connection. This built-in 10/100/1000 Base-T LAN module supports data transfer rate up to 1000Mbps.

For more instructions or detailed steps on connecting to the LAN, please ask your MIS staff or network manager for help.

Using the Modem

The built-in 56Kbps fax/data modem allows you to use a telephone line to communicate with others or to dial-up to connect the Internet.

For more instructions or detailed steps on dialing-up through the modem, please consult your MIS staff or Internet service provider (ISP) for help.



1. *To reduce the risk of fire, use only No. 26 AWG or larger telecommunication lone cord.*
2. *You are strongly recommended to install the modem driver included in the software CD of your Notebook to take full advantage of the modem feature.*

PC Card Installation

The PC card slot of your Notebook allows you to install comprehensive Type-II PC cards that support various functions for your necessary, including the LAN/WLAN card, modem card and memory card.

The following instruction provides you with a basic installation for the PC card, including how to install and remove it. For more information, please refer to the manual of your PC card.

Installing the PC card

1. Locate the PC card slot on your notebook Notebook. If there is the dummy card in the slot, remove it first.
2. Insert the PC card into the slot (usually with its label facing up) and push it until it is firmly seated.

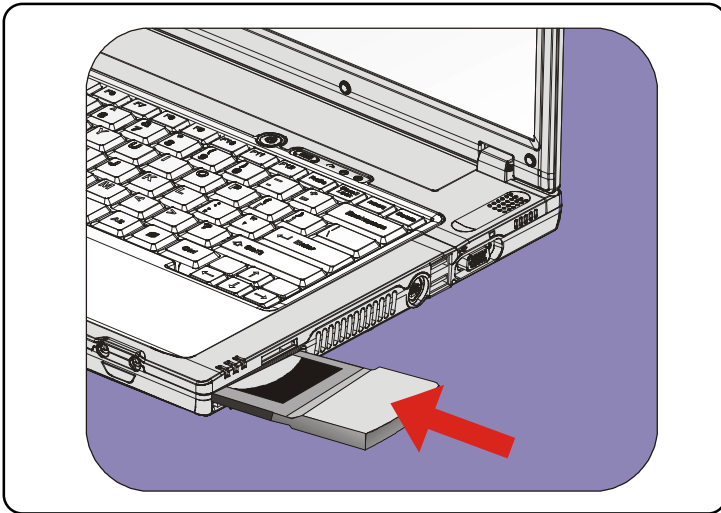

Removing the PC card

1. Press the Eject Button to make it stretch out.
2. Push the Eject Button and the PC card will slide out. Pull it out of the slot.

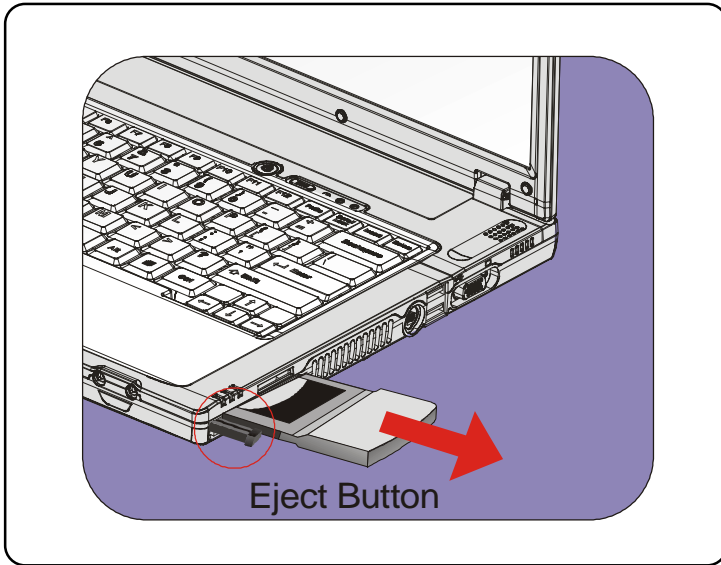

info

1. *Do not hold the "golden finger" when installing the PC card; otherwise, it may cause interference or damage to the PC card.*
2. *Before removing the PC card, you should stop the device in Windows operating system.*

Safely Remove Hardware

If you connect any peripheral device to your system, the **Safely Remove Hardware** icon () will appear on the taskbar. Double-click the icon to bring up the Safely Remove Hardware dialog box. You can see all connected peripheral devices here. If you want to remove any of the devices, move the cursor to the device and click **Stop**.

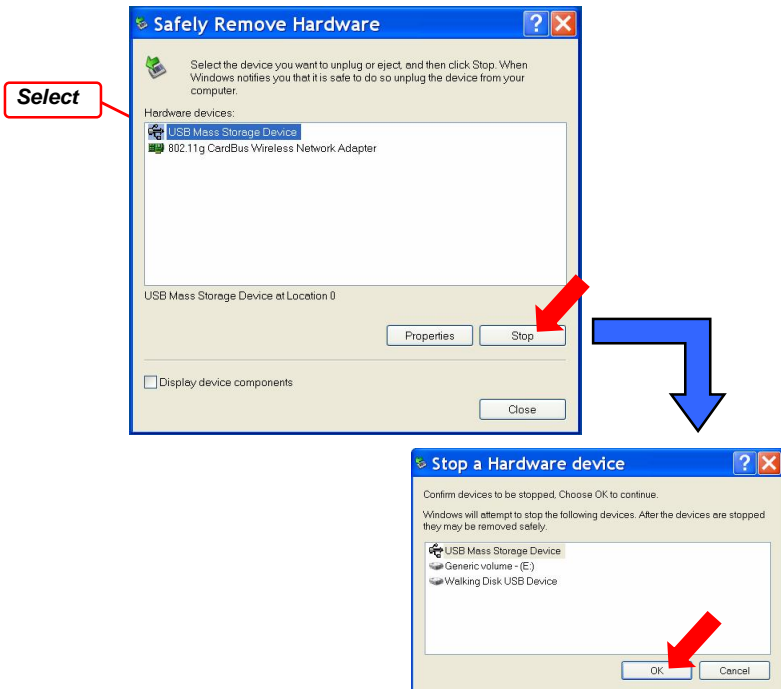



	Preface
Chapter 1	General Introductions
Chapter 2	Getting Started
Chapter 3	Customizing this Notebook
Chapter 4	BIOS setup



About BIOS Setup

When to Use BIOS Setup?

You may need to run the BIOS Setup when:

- w An error message appears on the screen during the system booting up and requests you to run SETUP.
- w You want to change the default settings for customized features.
- w You want to reload the default BIOS settings.

How to Run BIOS Setup?

To run the BIOS Setup Utility, turn on the Notebook and press the [Del] key during the POST procedure.

If the message disappears before you respond and you still wish to enter Setup, restart the system by turning it OFF and ON, or simultaneously pressing [Ctrl]+[Alt]+[Delete] keys to restart.











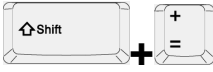

info

The screen snaps and setting options in this chapter are for your references only. The actual setting screens and options on your Notebook may be different because of BIOS update.

Control Keys

You can use only the keyboard to control the cursor in the BIOS Setup Utility.

	Press left arrow to select one menu title.
	Press right arrow to select one menu title.
	Press up arrow to select one item under the menu title.
	Press down arrow to select one item under the menu title.
	Increase the setting value or make changes.
	Decrease the setting value or make changes.
	<ol style="list-style-type: none"> 1) Open the selected item to change setting options. 2) Bring up a sub-menu when available.
	In some items, press this key to change setting field.
	Bring up help screen providing the information of control keys.
	<ol style="list-style-type: none"> 1) Exit the BIOS Setup Utility. 2) Return to the previous screen in a sub-menu.

BIOS Setup Menu

Once you enter the BIOS Setup Utility, the Main menu will appear on the screen. The Main menu displays the system information, including the basic configuration.

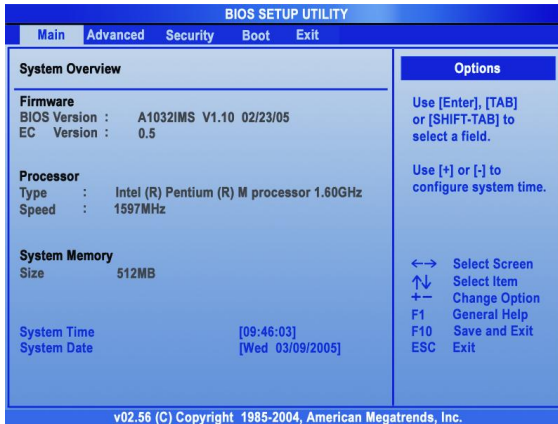

Main menu

Show System Overview information about BIOS version, CPU features, Memory size and setting of System Time and Date.

Advanced menu

Configure IDE and USB settings.

Security menu

Install or clear Supervisor's and User's Password settings.

Boot menu

Set up Boot Type and Boot Sequence.

Exit menu

Choose decided status before leaving the BIOS menu.

Main menu

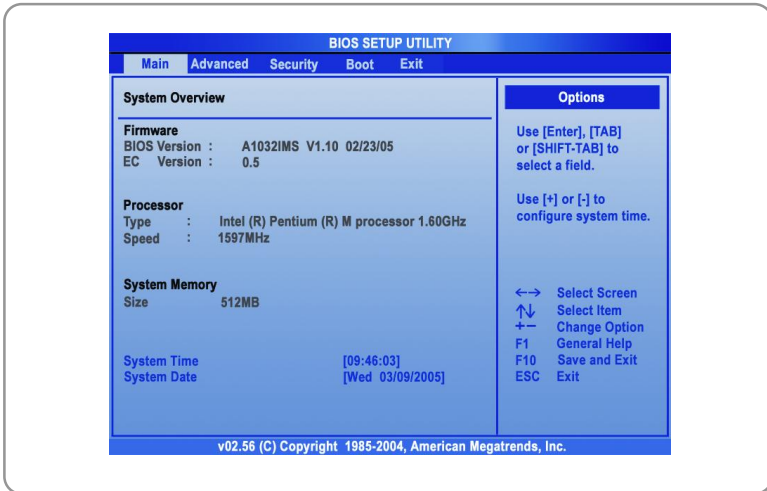

System Overview

System Overview will show you BIOS version and other information about its build date and update notes. Following is CPU's information about its Type and Speed.

The variable settings in Main menu are Share Memory, System Time and System Date.

Share Memory

Some devices need to share with PC's memory to accelerate their performance. Select an available and acceptable value from the menu.

There are modes of 1MB, 4MB, 8MB, 16MB, 32MB provided to select.

System Time

This item allows you to set the system time. The system clock will go on no matter you shut down the PC or get into sleep mode. The set format is [hour:minute:second].

System Date

This item allows you to set the system date. The date format is [day:month:date:year].

Day Day of the week, from Sun to Sat, which is determined by BIOS (read-only).

Month The month from 01 (January) to 12 (December).

Date The date from 01 to 31.

Year The year can be adjusted by users.

Advanced menu



Advanced Settings

Primary IDE Master/Slave

The two items display the types of the primary master/slave IDE devices installed in the Notebook. Press [Enter] to bring up a window showing the detailed information of the device, including the device name, vendor, LBA mode, PIO mode and more.

Legacy USB Support

If you want to use USB device, like mouse, keyboard, portable disk, in DOS system or boot your system by USB device, you should enable this function by select ***Enabled***.

Intel (R) SpeedStep (tm) tech.

This item allows you to enable or disable Intel SpeedStep technology. When set to **Disabled**, the system always operates in a conserve power mode (the processor works at FSB400-600MHz or FSB533-800MHz). If you want optimize the processor, set this item to **Enabled**, so that the processor's speed will be controlled by the use of your operating system and applications.

Security menu

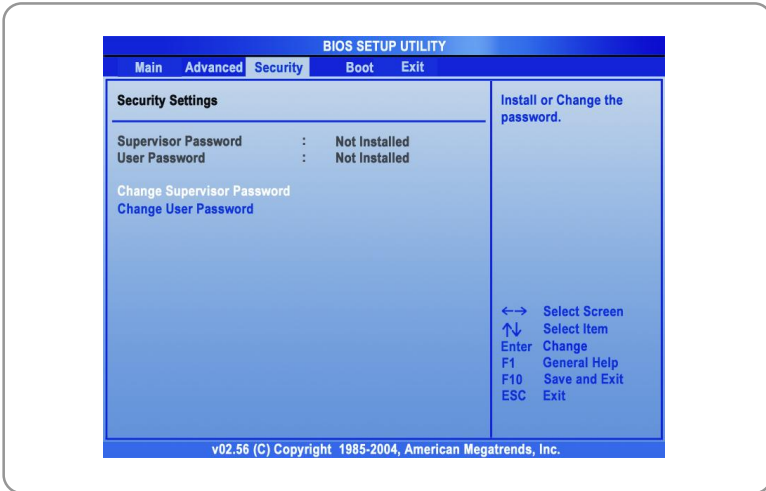

Security Settings

Change Supervisor/User Password

When you select the function, a message box will appear on the screen as below:

Enter New Password

Type the password *you* want, up to six characters in length and press [Enter]. The password typed now will replace any previously set password from CMOS memory. You may also press [ESC] to abort the selection and not enter a password.

When the Supervisor Password is set, the new item **User Access Level** and **Password Check** will be added in the menu. You can make further settings of access right in the **User Access Level** item. Setting options: **No Access, View Only, Limited** and **Full Access**. The Password Check item is used to specify the type of BIOS password protection that is implemented. Settings are described below:

Setup	The password prompt appears only when end users try to run Setup.
Always	A password prompt appears every time when the Notebook is powered on or when end users try to run Setup.

To clear a set password, just press **[Enter]** when you are prompted to enter the password. A message box will show up confirming the password will be disabled. Once the password is disabled, the system will boot and you can enter Setup without entering any password.



info

About Supervisor Password and User Password

Supervisor Password allows the user to enter and change the settings of the setup menu; User Password only allows the user to enter the setup menu, but do not have the right to make changes.

Boot menu

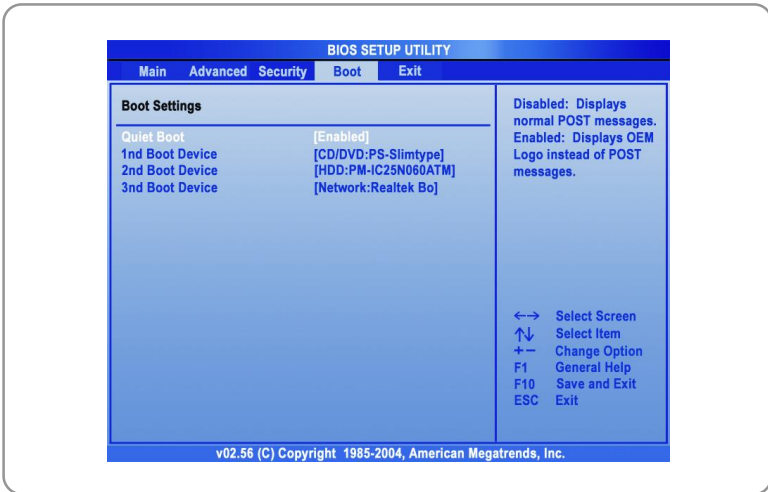

Quiet Boot

This item enables you to show the vendor logo on the boot-up screen.

Settings options: **Disabled** and **Enabled**. The default setting is **Enabled**.

1st, 2nd and 3rd Boot Device Setting

The three items allow you to set the sequence of boot devices where BIOS attempts to load the disk operating system.

Exit menu

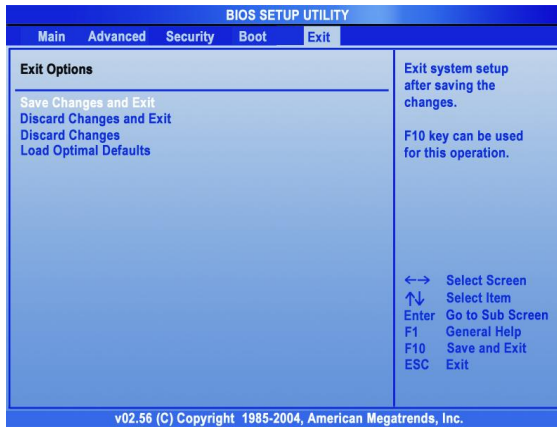

Save Changes and Exit

Save the changes you have made and exit the utility.

Discard Changes and Exit

Exit the utility without saving the changes you have made.

Discard Changes

Abandon your changes and reload the previous configuration before running the utility.

Load Optimal Defaults

Select this item to load the default settings for optimal system performance.