



5" Portable Color TV with DVD Player and AM/FM Radio



Instruction Manual

Please read this manual carefully before operation.

SAFETY INSTRUCTIONS

	CAUTION RISK OF ELECTRIC SHOCK DO NOT OPEN	
CAUTION: TO REDUCE THE RISK OF FIRE AND ELECTRIC SHOCK, DO NOT REMOVE THE COVER (OR BACK) OF THE UNIT. REFER SERVICING ONLY TO QUALIFIED SERVICE PERSONNEL.		

For Customer Use:

Enter below the serial number that is located on the bottom of the unit. Retain this information for future reference.

Model No. TV-DVD1260

Serial No. _____



The lightning flash with arrowhead symbol within an equilateral triangle is intended to alert the user to the presence of uninsulated "dangerous voltage" within the product's enclosure that may be of sufficient magnitude to constitute a risk of electric shock.



The exclamation point within an equilateral triangle is intended to alert the user to the presence of important operation and servicing instructions in the literature accompanying the appliance.

WARNING:

To prevent fire or shock hazard, do not expose this device to rain or moisture. Dangerous high voltage is present inside the enclosure. Do not open the cabinet.

CAUTION:

This Digital Video Disc player employs a laser system. To prevent direct exposure to the laser beam, do not try to open the enclosure or defeat the safety interlocks. When open and the interlocks are defeated, visible laser radiation is present.

Use of controls, adjustments, or performance of procedures other than those specified herein may result in hazardous radiation exposure. **DO NOT STARE INTO THE BEAM.**

FCC Notice:

This equipment has been tested and found to comply with the limits for a Class B digital device pursuant with the FCC Rules, Part 15. These limits are designed to provide reasonable protection against harmful interference in a residential installation. This equipment generates, uses, and can radiate radio frequency energy, and if not installed and used in accordance with the instructions may cause harmful interference to radio communication.

WARNING:

Handling the cords on this product will expose you to lead, a chemical known to the State of California to cause cancer, and birth defects or other reproductive harm. **Wash hands after handling.**

CAUTION:

To prevent electric shock, match wide blade of plug to wide slot of outlet and fully insert.

NOTICE:

This product incorporates copyright protection technology that is protected by U.S. patents and other intellectual property rights. Use of this copyright protection technology must be authorized by Macrovision, and is intended for home and other limited viewing uses only unless otherwise authorized by Macrovision. Reverse engineering or disassembly is prohibited.



For recycling or disposal information about this product, please contact your local authorities or the Electronics Industries Alliance: www.eiae.org.

SAFETY INSTRUCTIONS

1. Read these instructions carefully. Keep these instructions for future reference.
2. Heed all warnings and follow all instructions.
3. Do not expose to water or moisture.
4. Clean only with a dry cloth.
5. Keep objects away from ventilation openings. Do not block ventilation openings at any time.
6. Do not install near any apparatus that produces heat such as stoves, radiators, amplifiers, etc.
7. Do not force the power plug into a wall outlet. If the plug provided does not fit into your outlet, consult an electrician for replacement of the obsolete outlet. (A polarized plug has two blades where one is wider than the other; the wide blade is provided for your safety.)
8. Do not place heavy objects on the power cord. Protect the cord from being walked on, pinched by objects, or torn and exposed to liquids (especially at plugs, convenience receptacles, and the point at which they exit from the device).
9. Use only with attachments/accessories specified by the manufacturer. Use of attachments/accessories not recommended by the product manufacturer may be hazardous.
10. Unplug the device during lightning storms. Unplug the device and remove any batteries when the device will be unused for long periods of time.
11. Do not use this device near water. Do not place objects filled with liquids (eg, vases) on the device. Never spill liquid of any kind on the device.
12. Never push objects of any kind into this device through openings as they may touch dangerous voltage points or short out parts that could result in a fire or electric shock.
13. Do not use headphones/earphones while cycling, driving, or operating a motorized vehicle.
14. Do not use headphones/earphones at high volume.
15. Do not drop or otherwise subject the device to impact.
16. Do not open or attempt to repair this device. Refer all repairs to authorized service personnel.
17. When replacements parts are required, be sure the service technician has used replacement parts specified by the manufacturer or that have the same characteristics as the original part. Unauthorized substitutions may result in fire, electric shock, or other hazards.
18. Upon completion of any service or repairs to this device, ask the service technician to perform safety checks to determine that the device is in proper operating condition.

Note:

The main plug is used to disconnect the device. It should remain within reach and should not be obstructed during intended use.

The rating label is located on the bottom enclosure of the device.

TABLE OF CONTENTS

SAFETY INSTRUCTIONS	2
TABLE OF CONTENTS	4
ABOUT OPTICAL DISCS	6
Disc Requirements	6
Disc Care and Maintenance	6
Handling a Disc	6
Cleaning a Disc	6
PACKAGE CONTENTS	7
LOCATION OF CONTROLS	8
Side View (Right)	8
Front View	8
Top View	8
Remote Control	9
Battery Installation	9
CONNECTIONS	10
Audio/Video (AV) Connections	10
DVD Output	10
External Antenna Input	11
AV Signal Input	11
Dolby Pro Logic Surround (Digital Coaxial Audio) Connection	11
GETTING STARTED	12
Remote Control	12
Power Supply	12
Using the AC/DC Adapter	12
Battery Operation (DC)	12
BASIC OPERATIONS	13
Power Management	13
If the player will not be in use for a long period of time, set the Power Switch to the OFF position, remove the battery, and unplug the player.	13
Radio Function	13
TV Function	13
DVD Function	13
Play/Pause/Stop	13
Next/Previous (Skip)	14
Forward/Reverse (Search)	14
Slow	14
Menu Navigation	14
Numeric Keypad	14
Adjusting the Volume	14
Disc Error Messages	14



TABLE OF CONTENTS

MORE DVD FUNCTIONS	16
Display	16
Menu / Title / Return	16
Setup	16
Search	16
DVD Chapter/Title Search:	16
DVD Time Search (within a specified title):	16
CD Time Search:	16
Repeat Mode	17
Repeat A-B Mode	17
Multi-Angle/Subtitle/Audio	17
Zoom	17
Program	17
DVD Program Mode	18
CD Program Mode	18
DVD SETUP	19
Language Setup	19
Screen Setup	19
Audio Setup	20
Custom Setup	20
TV SETUP	21
Picture Setup	21
P.Lock (Parental Lock/V-Chip) Setup	21
Timer Setup	22
Preset Setup	23
Extra Setup	23
SPECIFICATIONS	24
TROUBLESHOOTING	25

ABOUT OPTICAL DISCS

Disc Requirements

This DVD player supports playback of the following discs.

Type	Disc Mark	Content Type	Disc Size	Max. Playback Time
DVD-Video Discs		Audio + Video (moving picture)	12 cm	133 min (SS-SL)
				242 min (SS-DL)
				266 min (DS-SL)
				484 min (DS-DL)
Audio Compact Discs (CDs)		Audio	12 cm	74 min
JPEG CDs	--	Still Picture	12 cm	--

This unit can play back CD-R and CD-RW discs that contain JPEG picture files. Discs not listed above are not supported by this unit (eg, PC CD-ROM, CD-Extra, CD-G, CD-I, etc.)

Disc Care and Maintenance

Optical discs (DVDs, CDs) contain high-density compressed data and need proper handling.

Handling a Disc

- Hold a DVD/CD by its edges. Avoid touching the recorded side of the disc. To remove a DVD/CD from its storage case, press down on the center retention mechanism of the case and lift the disc out.
- Do not subject discs to prolonged exposure to direct sunlight, high humidity, or high temperatures.
- Do not bend or press discs.
- To reduce the risk of scratches, always put discs back in their case after use. Store discs vertically in a cabinet.
- Do not place stickers or labels on either side of a disc.



Cleaning a Disc

Use a dry, soft cloth to wipe off any fingerprints and dusts from the playing surface of the disc. Wipe in a straight line radially from the center to the outside edge of the disc. Small dust particles and light stains will not affect playback quality.

- Never use chemicals such as record sprays, anti-static sprays, benzene, or thinners to clean a disc. Doing so will damage the surface of the disc permanently.

PACKAGE CONTENTS

Please make sure the following items are included in the package. If any items are missing, please contact your local dealer.



TV-DVD1260

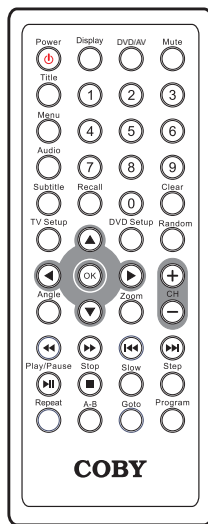

Remote Control

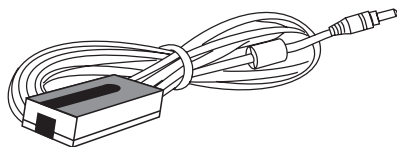

AC/DC Adapter

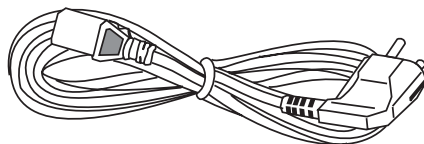

Power Cord

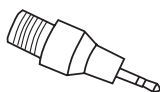

Antenna Adapter

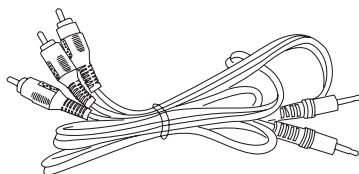

RCA Cable

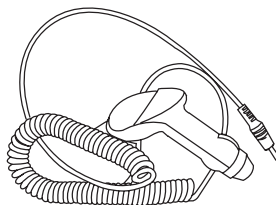

DC Car Cord

LOCATION OF CONTROLS

Side View (Right)

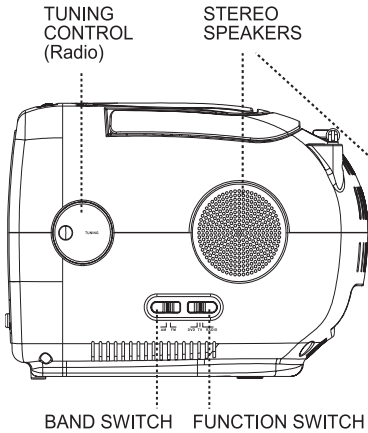

Top View

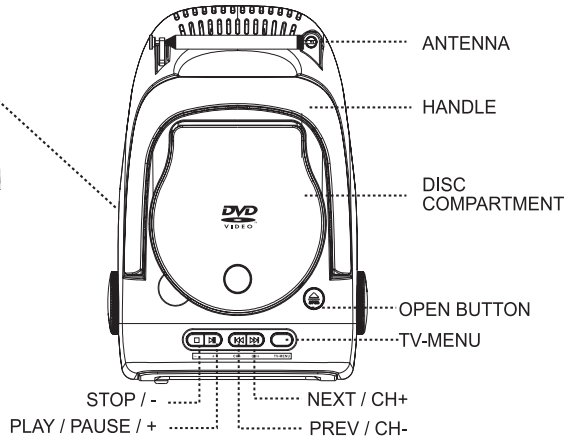

Front View

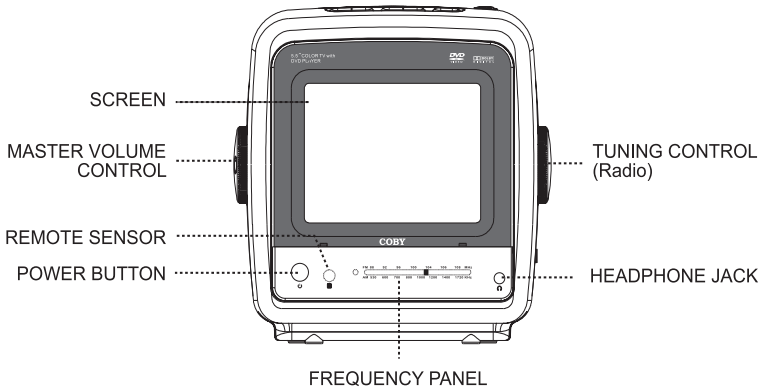

LOCATION OF CONTROLS

Remote Control

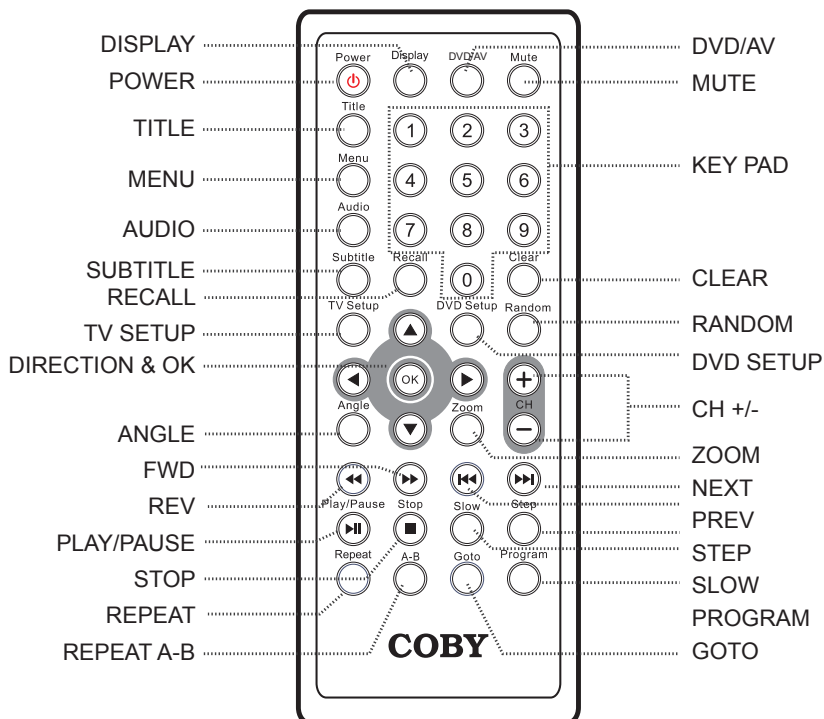

Battery Installation

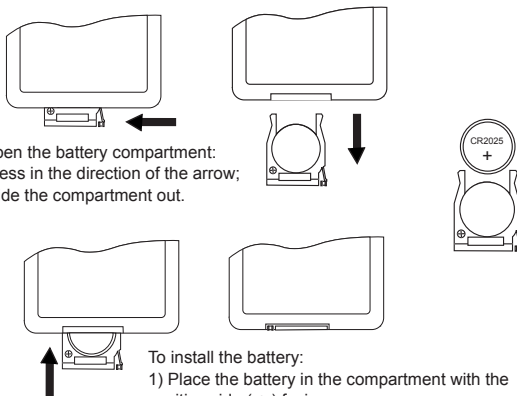

CONNECTIONS

Audio/Video (AV) Connections

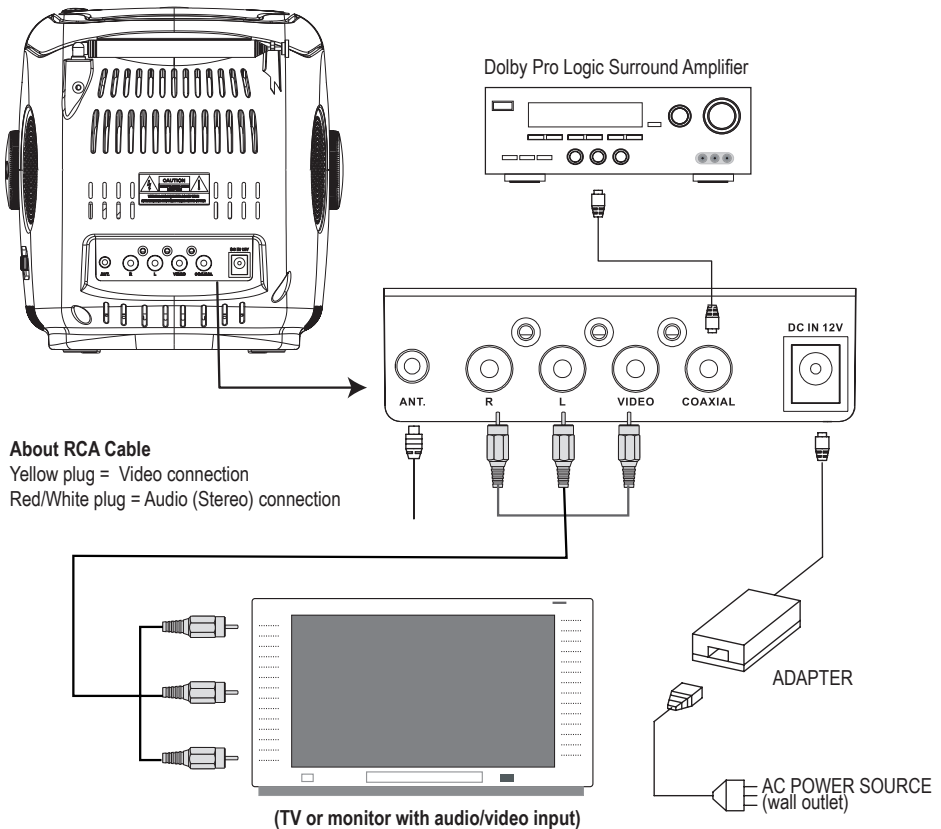

About RCA Cable

Yellow plug = Video connection

Red/White plug = Audio (Stereo) connection

DVD Output

Use the built-in DVD player with another television.

1. Set the Function Switch to the DVD position.
2. Connect the unit to a TV with the supplied AV Cable (R, L, VIDEO).
 - Alternately, you can use the Digital Coaxial (audio) jack to connect to a Dolby Pro Logic Surround amplifier for 5.1-channel surround sound. See the [Dolby Pro Logic Surround](#) section for more details.
3. Press the AV mode button on your TV to display your player's output signal on the screen.

NOTE:

- Refer to your TV's instruction manual for more information on setting it to the proper AV mode.
- Be sure to turn off and unplug your player and TV before making these connections.

CONNECTIONS

External Antenna Input

Use the TV with an external antenna instead of the built-in telescopic antenna.

1. Attach an external antenna (RF, Cable) to the external antenna adapter.
2. Plug the adapter into the external antenna jack (ANT.) of the unit.
3. Set the Function Switch to TV.

AV Signal Input

Use an external AV device (eg, VCR, camcorder, video game console) with the TV.

1. Connect the TV to an external AV device using the supplied AV Cable.
2. Set the Function Switch to the DVD position.
3. Pres DVD/AV to place the unit in AV mode.

Dolby Pro Logic Surround (Digital Coaxial Audio) Connection

This unit can output 5.1-channel surround sound audio through the Digital Coaxial audio jack. You will need a Dolby Pro Logic Surround amplifier and a digital coaxial cable to use this feature.

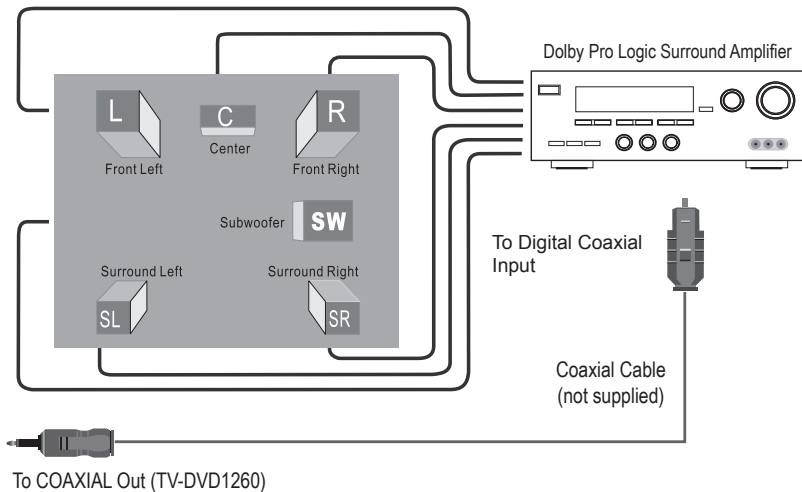

Note:

Please refer to your receiver's instruction manual for more information on how to properly set up your surround sound system.

GETTING STARTED

Remote Control

- To use the remote, point it at the remote sensor of the player. Operate the remote within 15 feet of the sensor and at an angle of +/- 60 degrees.
- Replace the battery if the remote control does not work.
- Remove the battery from the remote if it will not be used for a long period of time.

Power Supply

Using the AC/DC Adapter

This AC/DC adapter should be used with 100-240V 50/60Hz AC wall outlets.

- DC Out: 12V
- DC Current: 4.0A maximum

Caution:

- *Do not connect the power plug to a power outlet other than that which is indicated here and on the label as this may result in the risk of fire or electric shock.*
- *Do not handle the power plug with wet hands. Doing so may cause electric shock.*
- *Only use AC adapters of the type specified here. Failure to do so may cause a fire or damage the player.*

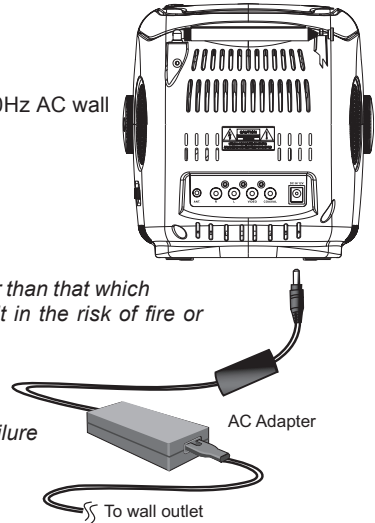

Battery Operation (DC)

This unit can be powered by 8 x "D" batteries. To install the batteries:

1. Remove the battery compartment cover by pushing it in the direction of the arrow.
2. Insert 8 "D" batteries, taking care to match the polarities (+ / -) with the markings in the battery compartment.
3. Replace the cover.

(The unit can function on AC power with the batteries installed.)

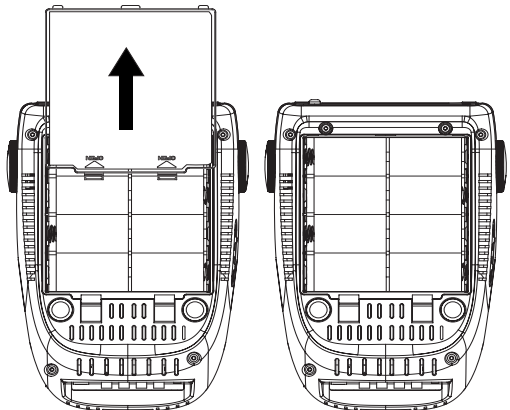

WARNING

- The batteries used in this device may present a fire or chemical burn if mistreated. Do not recharge, disassemble, incinerate, or heat the battery (~212°F).
- Keep batteries away from children.

BASIC OPERATIONS

Power Management

If the player will not be in use for a long period of time, set the Power Switch to the OFF position, remove the battery, and unplug the player.

Radio Function

1. Press POWER to turn on the unit.
2. Set the Function Switch to the RADIO position.
3. Set the Band Switch to the AM or FM position.
4. Tune into a desired broadcast station by turning the Tuning Control dial.
5. Adjust the volume level by turning the Volume Control dial.

TV Function







1. Press POWER to turn on the unit.
2. Set the Function Switch to the TV position.
3. Extend the telescopic antenna. Adjust the position of the antenna to maximize broadcast reception.
4. Change channels by pressing CH+ or CH- or access a channel directly using the numeric keypad (eg, press “2” then “1” to change to Channel 21).
5. Press RECALL to return to the previously viewed channel.
6. Adjust the volume level by turning the Volume Control dial.

Note: See the TV SETUP section for details about setting the TV options for this unit.

DVD Function



1. Press Power to turn on the unit.
2. Set the Function Switch to the DVD position.
3. Load a disc.
Press the Open button to open the disc compartment lid. Insert a disc with the label-side up. Close the lid by hand (the lid will click into place).
 - If a single-sided disc is inserted upside-down, the player will display “NO DISC” or “BAD DISC”.
3. Start playback.
Press PLAY to start playback (some discs may start playing automatically).

Play/Pause/Stop

- Press  to play the disc for the first time.
- Press  during playback to pause. Press  again to resume playback.
- Press  during playback to stop the disc (“Pre-Stop”). Press  to resume playback at the time-point at which the disc was stopped.
- Press  when the disc is “Pre-Stopped” to stop playback completely. (When  is pressed, the disc will start playing from the beginning.)





BASIC OPERATIONS

Next/Previous (Skip)

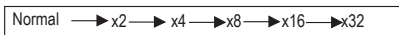
- Press  to skip forward one track (DVD, CD, etc).
- Press  to skip back one track (DVD, CD, etc).



Forward/Reverse (Search)

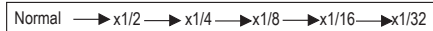

- Press  to fast-forward through the disc. Each successive press of  will change the rate of forward playback.
- Press  to fast-reverse through the disc. Each successive press of  will change the rate of reverse playback.

Slow



- Press SLOW for slow-motion playback. Each successive press of SLOW will change the rate of slow-motion playback. Press  to resume normal playback.
- Press STEP for frame-by-frame playback. Each successive press of STEP will advance the video one frame. Press  to resume normal playback.

Note:

Audio will be muted during fast-forward, fast-reverse, and slow-motion playback.

Menu Navigation

To navigate DVD disc menus or the player's setup menus:

- Press the DIRECTION buttons to select a desired feature or option in the menu.
- Press OK to confirm a selection in the menu.
 - For some menu options, you may be able to use the numeric keypad to input data.
- Press  to cancel an entry.

Numeric Keypad

- Use the numeric keypad to skip directly to a DVD chapter or CD track.
- Use the numeric keypad to input numeric data in menu option fields when possible.

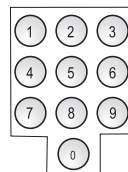

Adjusting the Volume

- Turn the Volume Control dial to adjust the volume level up or down.
- Press MUTE to turn the volume off completely; press mute again to restore the volume to its previous level.

Disc Error Messages

The following messages will be displayed on-screen if there is a problem with the format of the loaded disc.

- **WRONG REGIONAL DISC.** The region code of the disc does not match the player's region code (Region 1).

BASIC OPERATIONS

- **WRONG PASSWORD.** The parental rating level of the disc is higher than the parental rating level setting of the player. The player will not play the disc.
- **WRONG DISC.** The player is equipped with automatic disc quality detection software. If the player detects a disc that is damaged or has a format problem, it may play the disc at a lower quality or stop play completely, depending on how damaged the disc is.

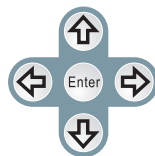

Note:

DVD disc production quality may vary; some discs may deviate from the industry standard. Some incorrectly formatted discs may still play, however, the playback and operational quality of the disc may be substandard.

MORE DVD FUNCTIONS

Display

- Press the DISPLAY button once to show time information on-screen; press it twice to show status information on-screen; press it a third time to exit the on-screen display mode.
- When the player is in AV IN mode, press the DISPLAY button to toggle between TV System modes (NTSC or PAL).

Menu / Title / Return

- Press the MENU button during DVD playback to return to the DVD's Main menu.
- Press the TITLE button during DVD playback to return to the DVD's Title menu.

Setup

Press the SETUP button to enter the player's setup menu. Enter the Setup menu to adjust the player's internal settings; please see the [SETUP](#) section for more details.

Search

Press SEARCH to go directly to a desired point of a disc (eg, Title, Chapter, Time).

DVD Chapter/Title Search:

- Press SEARCH once to display the Chapter/Title Search Bar shown to the right.
- Press the left/right DIRECTION buttons to select (highlight) an entry field.
- Use the Numeric keypad to input the desired chapter/title number, or press the up/down DIRECTION buttons to increase/decrease the chapter/title number.
- Press OK to confirm and execute the search or press SEARCH to exit search mode.



DVD Time Search (within a specified title):

- Press SEARCH twice to display the Time Search Bar shown to the right.
- Use the Numeric keypad to input the desired time (hours, minutes, seconds).
 - Press CLEAR to cancel any input errors.
- Press OK to confirm and execute the search or press SEARCH to exit search mode.



CD Time Search:

- Press SEARCH once to display the CD Time Search Bar shown to the right.
- Use the Numeric keypad to input the desired time (hours, minutes, seconds).
 - Press CLEAR to cancel any input errors.
- Press OK to confirm and execute the search or press SEARCH to exit search mode.



MORE DVD FUNCTIONS

Repeat Mode

Press REPEAT to change the repeat mode of the player. Each successive press of REPEAT will change the mode as follows:

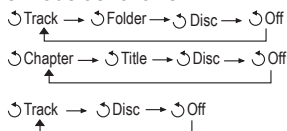

Note:

Some DVD discs do not allow Repeat mode.

Repeat A-B Mode

To repeat playback of a specific section of a disc (loop):

1. Press A-B to set the desired start point ("A") of the section to be repeated.
2. Press A-B again to set the desired end point ("B" of the section to be repeated.
3. The section "A-B" will now play repeatedly as a loop. Press A-B again to resume normal playback.

Multi-Angle/Subtitle/Audio

- During playback of a DVD that has been mastered with multiple angles, press ANGLE to view the available alternate camera angles. (A DVD may have up to 9 selectable angles.)
- During playback of a DVD that has been mastered with subtitles, press SUBTITLE to view the available subtitle tracks. (A DVD may have up to 32 selectable subtitles.)
- During playback of a DVD that has been mastered with alternate language/audio tracks, press AUDIO to hear the alternate tracks. (A DVD may have up to 8 selectable audio tracks.)

Zoom

Press ZOOM to change the magnification level of the picture.

- During DVD playback, each successive press of ZOOM will change the level of magnification to: Zoom 2x, Zoom 4x, Normal.
- During JPEG CD playback, each successive press of ZOOM will change the level of magnification to: 25%, 50%, 100%, 150%, 200%.

When the magnification level is greater than Normal/100%, use the DIRECTION buttons to pan around the magnified picture.

Note: *The picture quality will decrease as the zoom level increases.*

Program

Enter Program mode to create a custom sequence of tracks to be played.

(Program mode is available only when the player is in NAVIGATE OFF mode. Press the PBC button to set the player to NAVIGATE OFF mode.)

Note: *You can also use the numeric keypad to enter numbers directly in the fields. Use the direction buttons to move between entry fields.*

MORE DVD FUNCTIONS

DVD Program Mode

1. Load a DVD and press PROGRAM.
2. Press the right DIRECTION button to select the "Title" column; press the up/down DIRECTION buttons to select a title.
3. Press the right DIRECTION button to select the "Chapter" column; press the up/down DIRECTION buttons to select a chapter.
4. Press PLAY (or OK) to confirm the selection.
5. Repeat steps 2-4 until you have finished programming your selections or when you have programmed the maximum 20 tracks.
6. Press PLAY to start playback. Press PROGRAM to cancel.

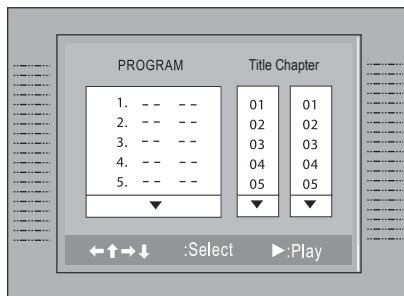

CD Program Mode

1. Load a CD and press PROGRAM.
2. Press the right DIRECTION button to select the "Track" column; press the up/down DIRECTION buttons to select a track.
3. Press PLAY (or OK) to confirm the selection.
4. Repeat steps 2-3 until you have finished programming your selections or when you have programmed the maximum 20 tracks.
5. Press PLAY to start playback. Press PROGRAM to cancel.

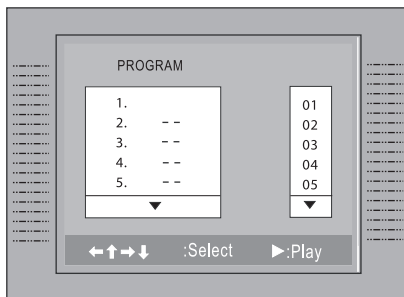

DVD SETUP

Enter DVD Setup mode to adjust the various internal settings of the built-in DVD player. Make sure the player has been completely stopped before entering Setup mode.

1. Press DVD SETUP to enter Setup mode.
2. Use the DIRECTION buttons to select a desired item.
3. Press OK to confirm a selection.
4. Press DVD SETUP to exit Setup mode (or select EXIT and press OK).

Language Setup

Use the DIRECTION buttons to highlight the desired language selection and press OK to confirm.

Item	Description	Options (Default is in Bold)
OSD	Sets the language of the player's on-screen display.	English , French, German, Italian
Menu	Sets the default menu language of loaded DVDs.	English , Chinese, Japanese, French, German, Italian, Spanish, Portuguese, Hindi, Thai, Russian, Korean, Others
Audio	Sets the default language audio track of loaded DVDs.	English , Chinese, Japanese, French, German, Italian, Spanish, Portuguese, Hindi, Thai, Russian, Korean, Others
Subtitle	Sets the default subtitle track of loaded DVDs.	English , Chinese, Japanese, French, German, Italian, Spanish, Portuguese, Hindi, Thai, Russian, Korean, Others

Screen Setup

Use the DIRECTION buttons to highlight the desired screen selection and press OK to confirm.

Item	Description	Options (Default is in Bold)
TV Type	Sets the aspect ratio of the display. (The TF-DVD7307 screen is 16:9.)	4:3 (PS) , 4:3 (LB), 16:9
Screen Saver	The screensaver prevents burn-in damage to the player's screen.	On , Off
TV System	Sets the player's Video Out signal type. Set this to correspond with your TV.	NTSC , PAL, Auto
Brightness	Select a preset screen brightness.	Normal , Bright, Soft
Contrast	Adjust the screen's contrast.	-4 to +4 (0 is default)

DVD SETUP

Audio Setup

Use the DIRECTION buttons to highlight the desired audio selection and press OK to confirm.

Item	Description	Options (Default is in Bold)
Digital Out	Sets the player's Digital Coaxial Out (audio) signal. For use with 5.1-channel receivers (see your receiver's manuals for more details).	SPDIF/RAW , SPDIF/PCM, Off

Custom Setup

Use the DIRECTION buttons to highlight the desired Custom Setup selection and press OK to confirm.

Item	Description	Options (Default is in Bold)
Parental Ctrl	Sets the maturity rating level of the player. The player will not play any discs rated higher than this setting. <u>This setting is password protected (the default password is: 8888).</u>	Levels 1 to 8. (8: ADULT is default)
Password	Change the Parental Ctrl password. Enter the old password, the new password, and then the new password again to verify. DO NOT FORGET THE PASSWORD; this password cannot be reset.	
Angle Mark	Displays an on-screen prompt whenever an alternate angle becomes available for viewing (press ANGLE to view).	On , Off
Default	Resets all settings to their factory-default state. This will not reset the Parental Ctrl password.	Read

Note:

The DVD Setup mode controls the built-in DVD options only. To access the TV Setup mode, press TV SETUP. Refer to the TV SETUP section for more details about TV Setup options.

TV SETUP

Enter TV Setup mode to adjust the various internal settings of the Television.

Using the Remote:

1. Press TV SETUP to enter TV Setup mode.
2. Use the DIRECTION buttons to select a desired item.
3. Press OK to confirm a selection.
 - If necessary, you may use the numeric keypad to input data and then press OK to confirm.
4. Press DVD SETUP to exit Setup mode (or select EXIT and press OK).

◆ PICTURE	CONTRAST
P.LOCK	BRIGHT
TIMER	COLOR
PRESET	TINT
EXTRA	SHARPNESS

Using the Main Unit buttons:

1. Press MENU to enter TV Setup mode.
2. To select a desired item:
 - Press VOL - to move the selection left; press VOL + to move the selection right.
 - Press CH - to move the selection down; press CH + to move the selection up.
3. Press OK to confirm a selection.
4. Press MENU to exit Setup mode (or select EXIT and press OK).

Picture Setup

Use the DIRECTION buttons to highlight the desired picture selection and press OK to confirm.

Item	Description
Contrast	Adjust the screen's contrast.
Bright	Adjust the screen's brightness.
Color	Adjust the screen's color saturation.
Tint	Adjust the screen's tint.
Sharpness	Adjust the screen's sharpness.

P.Lock (Parental Lock/V-Chip) Setup

Use the DIRECTION buttons to highlight the desired P.Lock selection and press OK to confirm.

The P.LOCK options control the built-in V-Chip feature of this television. TV broadcasts include a signal that classifies the contents of the program. When this feature is activated, the TV will detect this signal and block any programs that are rated higher than what you have set.

TV SETUP

There are two different rating systems: MPAA (movies) and TV (television broadcasts).

MPAA Ratings:

- X: For adults only
- NC17: Not intended for ages under 17
- R: Restricted
- PG-13: Not intended for ages under 13
- PG: Parental Guidance Suggested
- G: General Audience

TV Ratings:

- MA: Mature Audiences only
- 14: Not intended for ages under 14
- PG: Parental guidance suggested
- G: General audience
- Y7: For children age 7 and above.
- Y: All children

The TV ratings are further classified by sub-categories. As the TV Rating increases, so does the intensity of the sub-category.

TV Subcategories:

- D: Suggestive dialogue
- L: Indecent language
- S: Sexual situations
- V: Violence

To change these settings, you must first use the numeric keypad to enter the P.LOCK code.

- **The default 4-digit code is: 5963.**

Item	Description
CH LOCK	Block a specific channel
V-CHIP	Set the allowable V-CHIP rating level.

Timer Setup

Use the DIRECTION buttons to highlight the desired timer selection and press OK to confirm.

Item	Description
On Timer	Set a time for the TV to turn on automatically
On CH	Set the channel the TV will be tuned to
Clock	Set the internal clock time of the TV

TV SETUP

Preset Setup

Use the DIRECTION buttons to highlight the desired preset selection and press OK to confirm.

Item	Description
CH no	Select the channel you wish to add or delete
CH Deleted	Press LEFT or RIGHT to toggle between ADD or DELETE
Antenna	Press LEFT or RIGHT to toggle the antenna setting between CABLE or AIR
Auto Program	Press LEFT or RIGHT to initiate the Auto Program feature. The TV will automatically detect signals within reception range and store them to memory.

Extra Setup

Use the DIRECTION buttons to highlight the desired Extra selection and press OK to confirm.

Item	Description
	Set the closed-caption display mode.
Language	Set the menu language
Background	Toggle the background feature ON or OFF. When this is set to ON, the TV will display a blue screen (instead of static) when no signal is detected.
Auto Program	Press LEFT or RIGHT to initiate the Auto Program feature. The TV will automatically detect signals within reception range and store them to memory.

SPECIFICATIONS

Power Supply	AC: 100-240V UL Listed Adapter DC: 9V, 2A
Power Consumption	≤ 9.8W
Video Signal System	NTSC / PAL
Video Output	3.5mm mini-jack to RCA Composite Video
Audio Output	3.5mm Stereo Headphone 3.5mm Stereo Line-Out Optical Out
Video Input	3.5mm mini-jack to RCA Composite Video
Audio Input	3.5mm Stereo Line-In
S/N Ratio	90dB Typical
Dynamic Range (Audio)	90dB Typical
Display Type	7" TFT LCD (16:9 Wide Screen)
Display Resolution	480 x 234
Unit Dimensions	7.76" x 1.57" x 6.61" (WHD)
Weight	2.14 lbs (main unit)

TROUBLESHOOTING

If you have a problem with this player, please read the troubleshooting guide below and check our website at www.cobyusa.com for Frequently Asked Questions (FAQs) and firmware updates. If these resources do not resolve the problem, please contact Technical Support.

COBY Electronics Technical Support

Hours: Monday to Friday, 8:30 AM–11:00 PM EST
Saturday to Sunday, 9:00 AM–11:00 PM EST

Email: techsupport@cobyusa.com

Phone: 800-681-2629 or 718-416-3197

Web: www.cobyusa.com

There is no power to the device.

- Ensure that the Power Switch is physically set to the ON position.
- Ensure that the AC adapter cord is securely connected to the player and the proper wall outlet.
- Ensure that the battery pack is fully charged.

The device does not play.

- Ensure that a supported disc is loaded in the player label-side up.
- Ensure that the disc's rating level does not exceed the player's.
- Ensure that the disc is not damaged or too dirty. Clean the disc or try another disc.
- Moisture may have condensed inside the player. Remove the disc and leave the player on for 1-2 hours and then try again.

There is no picture.

- Ensure that the AV switch is set to the correct mode (AV IN or AV OUT).
- Ensure that the TV set has been powered on and is set to the correct AV mode.
- Ensure that the connections between the player and the TV are secure and correct.
- Check if the connection cables are damaged.

The picture is noisy or distorted.

- The disc may be damaged or dirty. Clean the disc or try another one.
- Reset your TV's color system.
- Ensure that the player is connected directly to the TV (and not through a VCR, cable box, satellite receiver, etc.)

There is no sound or distorted sound.

- Ensure that the TV and amplifier have been turned on and properly set up.
- Ensure that the TV and amplifier connections are secure and correct.
- Try a different Audio track of the DVD by pressing AUDIO.
- Ensure that the MUTE function of the TV, Amplifier, or Player is not engaged.

TROUBLESHOOTING

The remote control doesn't work.

- Ensure that the Power Switch has been physically set to the ON position.
- Ensure that there are no obstacles between the remote and the player.
- Point the remote at the remote sensor on the main unit.
- Ensure that the batteries in the remote retain a charge and have been installed correctly.
- Try replacing the remote's batteries.

The player has malfunctioned.

- Unplug the player and remove the battery pack for 30 minutes. After that, reinstall the battery and plug in the player. Power on the player -- the restore function should reset the player.

COBY Electronics Corp.

56-65 Rust Street
Maspeth, NY 11378

www.cobyusa.com
www.ecoby.com