



# *AF-300 C11*<sup>TM</sup>

*User's Guide*



# TABLE OF CONTENTS

<b>1</b>	<b>BEFORE USING THIS PRODUCT.....</b>	<b>11</b>	<b>8</b>	<b>MAINTENANCE AND INSPECTION.</b>	<b>70</b>
1-1	RECEIVING INSPECTIONS.....	11	8-1	DAILY INSPECTION.....	70
1-2	APPEARANCE.....	12	8-2	PERIODIC INSPECTION.....	70
1-3	HANDLING THE PRODUCT.....	13	8-3	ELECTRICAL MEASUREMENTS IN THE MAIN CIRCUIT.....	73
1-4	CARRYING.....	14	8-4	INSULATION TEST.....	74
1-5	STORAGE AND TRANSPORTATION.....	14	8-5	INQUIRIES ABOUT PRODUCTS AND PRODUCT WARRANTY.....	75
<b>2</b>	<b>INSTALLATION AND CONNECTION</b>	<b>15</b>	8-6	WARRANTY SERVICE.....	76
2-1	OPERATING ENVIRONMENT.....	15	<b>9</b>	<b>SPECIFICATIONS.....</b>	<b>78</b>
2-2	INSTALLATION METHOD.....	15	9-1	STANDARD SPECIFICATIONS.....	78
2-3	CONNECTION.....	16	9-2	COMMON SPECIFICATIONS.....	80
2-3-1	Basic connection.....	16	9-3	DIMENSIONS.....	84
2-3-2	Connecting the main circuit and ground terminals.....	17	<b>10</b>	<b>OPTIONS.....</b>	<b>87</b>
2-3-3	Connecting the control terminals	18	10-1	BUILT-IN OPTIONS.....	87
2-3-4	Connection examples.....	23	10-2	EXTERNAL OPTIONS.....	87
2-4	OTHERS.....	27	<b>11</b>	<b>APPLICABLE DC REACTORS.....</b>	<b>88</b>
2-4-1	Harmonic component.....	27	<b>12</b>	<b>COMPLIANCE WITH STANDARDS.....</b>	<b>89</b>
2-4-2	Noise.....	27	12-1	UL/CUL STANDARDS [APPLICABLE TO PRODUCTS WITH UL/CUL MARK].....	89
2-4-3	Leakage current.....	27	12-1-1	General.....	89
<b>3</b>	<b>OPERATION.....</b>	<b>28</b>	12-2-2	Precautions.....	89
3-1	INSPECTION AND PREPARATION BEFORE OPERATION.....	28	12-2	COMPLIANCE WITH EMC DIRECTIVE IN EU [APPLICABLE TO PRODUCTS WITH CE MARK].....	90
3-2	OPERATION METHOD.....	28	12-2-1	General.....	90
3-3	TRIAL RUN.....	29	12-3	COMPLIANCE WITH LOW VOLTAGE DIRECTIVE IN EU [APPLICABLE TO PRODUCTS WITH TÜV OR CE MARK] .	90
<b>4</b>	<b>KEYPAD PANEL.....</b>	<b>30</b>	12-3-1	General.....	90
4-1	NAMES AND FUNCTIONS.....	30	12-3-2	Precautions.....	90
4-2	OPERATING KEYPAD PANEL.....	31	<b>13</b>	<b>ELECTROMAGNETIC COMPATIBILITY (EMC).....</b>	<b>91</b>
<b>5</b>	<b>SELECTING FUNCTION.....</b>	<b>33</b>	13-1	GENERAL.....	91
5-1	FUNCTION SELECTION LIST.....	33	13-2	RFI FILTERS.....	91
5-2	DETAILS OF EACH FUNCTION.....	38	13-3	ELECTROMAGNETIC COMPATIBILITY (EMC) RECOMMENDED INSTALLATION INSTRUCTIONS.....	94
<b>6</b>	<b>PROTECTIVE FUNCTION.....</b>	<b>59</b>			
6-1	LIST OF PROTECTIVE FUNCTIONS.....	59			
6-2	ALARM RESET.....	60			
<b>7</b>	<b>TROUBLESHOOTING.....</b>	<b>61</b>			
7-1	IN CASE OF TRIPPING.....	61			
7-2	OTHER TROUBLE.....	67			

# Safety Instructions

Read this operation manual carefully and familiarize yourself with the operation of the drive before installation, connection (wiring), operation or maintenance and inspection of the device. Be familiar with the drive, safety information, and safety signs before using the drive. In this instruction manual, safety signs are classified into the following categories.

<b>WARNING</b>	Improper operation may result in death of serious injury.
<b>CAUTION</b>	Improper operation may result in slight to medium injury or property damage.

Note: More serious situations than those covered by the CAUTION sign can result depending on the circumstances. It is important that you always follow the instructions

## Compliance with UL/cUL standards [Applicable to products with UL/cUL mark]

### CAUTION

1. [WARNING] Take care of electric shock. Be sure to turn the drive off before starting work.
2. [CAUTION] When the charge lamp is lit, the drive is still charged at a dangerous voltage.
3. [WARNING] There are two or more live parts inside the drive.
4. The drive is approved as a part used inside a panel. Install it inside a panel.
5. Perform wiring to the input, output and control terminals of the drive, referring to the table below. Use UL certified round crimp terminal to the input and output terminals with insulation cover or covered with reduced tube to obtain the insulation distance. Use a crimping tool recommended by the terminal manufacturer when fabricating crimp terminals.
6. Install a fuse in the power supply to the drive, referring to the table below.

Voltage	Drive type	Tightening torque Lb • Inch[N • m]		Applicable wire diameter [AWG] (mm <sup>2,2</sup> )		Fuse [A] <sup>3</sup>	Recommended fuse	
		L1/R, L2/S, L3/T <sup>1)</sup> U. V. W	Control section	L1/R, L2/S, L3/T <sup>1)</sup> U. V. W	Control section		Gould Company	Bussmann Company
3-phase 230V input	6KC1123F12X1**	10.6 (1.2)	3.5 (0.4)	14 (2.1)	20 (0.5)	3	A4J3	JKS3
	6KC1123F25X1**					6	A4J6	JKS6
	6KC1123F50X1**					10	A4J10	JKS10
	6KC1123001X1**					15	A4J15	JKS15
	6KC1123002X1**					20	A4J20	JKS20
	6KC1123003X1**					30	A4J30	JKS30
	6KC1123005X1**	40		A4J40		JKS40		
Single-phase 230V input	6KC1121F12X1**	10.6 (1.2)	3.5 (0.4)	14 (2.1)	20 (0.5)	6	A4J6	JKS6
	6KC1121F25X1**					6	A4J6	JKS6
	6KC1121F50X1**					10	A4J10	JKS10
	6KC1121001X1**					15	A4J15	JKS15
	6KC1121002X1**					30	A4J30	JKS30
	6KC1121003X1**	40		A4J40		JKS40		
		15.9 (1.8)		10 (5.3)				


- 1) Only the L1/L and L2/N phases are provided for the single-phase 230V input series.
- 2) Use copper wires of allowable maximum temperature 60 or 75 °C.
- 3) Use UL certified "fast acting fuse."

Connect the power supply satisfying the characteristics shown in the table below as an input power supply of the drive. (Short circuit rating)

Drive type	Input max. volta	Input current
3 Phase input	AC230V	5,000 A or less
Single phase input	AC240V	

## Compliance with low voltage directive in EU [Applicable to products with TÜV mark]

### CAUTION

1. Safe separation for control interface of this drive is provided when this drive is installed in overvoltage category II. PELV(Protective Extra Low Voltage) circuit or SELV(Safety Extra Low Voltage) circuit from external controller is connected to the interface directly.
2. Basic insulation for control interface of this drive is provided when this drive is installed in overvoltage category III. An isolation transformer has to be installed between power supply mains and this drive when SELV circuit from external controller is connected to this drive directly. Otherwise supplementary insulation between control interface of this drive and environment must be provided.
3. The ground terminal G should always be connected to the ground. Don't use only RCD as the sole method of electric shock protection.  
Dimensions of external PE conductor should be same as dimensions of input phase conductor and capable for possible fault.
4. Use MCCB or MC that conforms to EN or IEC standard.
5. Where RCD (Residual-current-operated protective device) is used for protection in case of direct or indirect contact, only **RCD of type B** is allowed on the supply side of this EE (Electric equipment). Otherwise another protective measure shall be applied such as separation of the EE from the environment by double or reinforced insulation or isolation of EE and supply system by the transformer.
6. The drive has to be installed in environment of pollution degree 2. If the environment is pollution degree 3 or 4, the drive has to be installed in a cabinet of IP54 or higher.
7. Use a prescribed wire according to the EN60204 Appendix C.
8. Install the drive, AC or DC reactor, output filter in an enclosure that meets the following requirement, to prevent a human body from touching directly to these equipment.
  - 1) When a person can touch easily on each connecting terminal or live parts, install the drive, AC or DC reactor, output filter in an enclosure with minimum degree of protection of IP4X.
  - 2) When a person can not touch easily on each connecting terminal or live parts, install the drive, AC or DC reactor, output filter in an enclosure with a minimum degree of protection of IP2X.
9. It is necessary to install the drive in appropriate method using an appropriate RFI filter to conform to the EMC directive. It is customer's responsibility to check whether the equipment ,the drive is installed in, conforms to EMC directive.

**Compliance with low voltage directive in EU [Continued]**

**⚠ CAUTION**

Use of wires specified in Appendix C of EN 60204 is recommended.

Power supply voltage	Nominal applied motor [HP]	Drive type	Recommended wire size AWG (mm <sup>2</sup> )						
			Molded case circuit breaker (MCCB) or earth leakage circuit breaker (ELCB) Rated current [A]		Input circuit <sup>*2</sup> 3-phase 200V [L1/R, L2/S, L3/T], single phase 200V [L1/L, L2/N]		Output circuit <sup>*2</sup> [U. V. W]	DCR <sup>*2</sup> circuit [P1] [P(+)]	Control wiring
			With DCR	Without reactor <sup>*3</sup>	With DCR	Without reactor <sup>*3</sup>			
3-phase 230V	1/8	6KC1123F12X1**	5	5	14 (2.5) <sup>*4</sup>	14 (2.5) <sup>*4</sup>	14 (2.5) <sup>*4</sup>	14 (2.5) <sup>*4</sup>	20 (0.5)
	1/4	6KC1123F25X1**							
	1/2	6KC1123F50X1**							
	1	6KC1123001X1**	10	15	14 (2.5) <sup>*4</sup>	14 (2.5) <sup>*4</sup>	14 (2.5) <sup>*4</sup>	14 (2.5) <sup>*4</sup>	
	2	6KC1123002X1**							
	3	6KC1123003X1**							
	5	6KC1123005X1**	20	30	12 (4.0) <sup>*5</sup>	10 (6.0) <sup>*5</sup>	12 (4.0) <sup>*5</sup>	12 (4.0) <sup>*5</sup>	
Single phase 230V	1/8	6KC1121F12X1**	5	5	14 (2.5) <sup>*4</sup>	14 (2.5) <sup>*4</sup>	14 (2.5) <sup>*4</sup>	14 (2.5) <sup>*4</sup>	
	1/4	6KC1121F25X1**							
	1/2	6KC1121F50X1**							
	1	6KC1121001X1**	10	15	14 (2.5) <sup>*4</sup>	14 (2.5) <sup>*4</sup>	14 (2.5) <sup>*4</sup>	14 (2.5) <sup>*4</sup>	
	2	6KC1121002X1**	15	20					(4.0) <sup>*4</sup>
	3	6KC1121003X1**	20	30	12 (4.0) <sup>*5</sup>	10 (6.0) <sup>*5</sup>	14 (2.5) <sup>*5</sup>	12 (4.0) <sup>*5</sup>	

- \*1 The applicable frame and series of the molded case circuit breaker (MCCB) and earth leakage circuit breaker (ELCB) vary according to the capacity of the transformer of the equipment. For details of selection, refer to the concerning technical documents.
- \*2 The recommended wire size for the main circuit is the case for the low voltage directive at ambient temperature 40 °C.
- \*3 The power supply impedance without a reactor is considered to be the equivalent of 0.1% of the drive capacity, with 10% current imbalance accompanied by the voltage imbalance.
- \*4 Crimp terminals up to 0.29" (7.4 mm) in width (including tolerance) can be used.
- \*5 Crimp terminals up to 0.37" (9.5 mm) in width (including tolerance) can be used.
- \*6 Use the grounding cable of a size equal to or larger than that of the input power supply cable.

## Instructions on use

### **WARNING**

1. This drive is designed to drive a three-phase induction motor and is not usable for a single-phase motor or any other purposes.  
**There is a risk of fire**
2. This drive may not be used as is for an elevator, life-support system, or other purpose directly affecting the safety of humans.  
Safety precautions should be established and practiced in terms of the entire system, rather than the independent device.  
**Otherwise, an accident could occur.**

## Instructions on transport/installation

### **WARNING**

1. Attach the device to an incombustible material such as metal,  
**otherwise fire could occur**
2. Do not place the device near inflammables.  
**Otherwise fire could occur**

### **CAUTION**

1. Do not carry the device by holding just the surface cover.  
**Drive may be dropped causing injury.**
2. Do not allow foreign matter such as lint, paper dust, small chips of wood or metal, and dust to enter the drive or adhere to the heat sink.  
**Otherwise, a disaster such as burning could occur.**
3. Do not install or operate damaged drive or a drive with a missing part,  
**otherwise injury could occur.**
4. Do not step on the product,  
**otherwise injury could occur.**
5. When stacking up in tiers, do not exceed the number of tiers indicated on the packing carton.  
**Otherwise injury could occur.**

## Instructions on wiring

### **WARNING**

1. When the drive is connected to power, connect it via a line-protection molded case circuit breaker or an earth-leakage circuit breaker (Residual current operated protective device).  
**Otherwise, fire could occur.**
2. Be sure to connect the ground wire,  
**otherwise electric shock or fire could occur.**
3. Ensure that a licensed specialist  
**performs the wiring work.**
4. Check before starting the wiring that the power is off (OPEN),  
**otherwise electric shock could occur.**
5. Do not wire up the drive until it has been installed securely,  
**otherwise electric shock or injury could occur.**
6. The drive has to be grounded in accordance with the national and local safety specification  
**otherwise electric shock could occur.**

### **CAUTION**

1. Check that the number of phases and the rated voltage of this product correspond to the number of phases and voltage of the AC power supply,  
**otherwise fire could occur.**
2. Do not connect the AC power supply to the output terminals (U, V, W),  
**otherwise injury could occur.**
3. Check the output terminals (U,V,W) for the phase order and connect them to the motor correctly,  
**otherwise fire could occur.**
4. Do not connect a braking resistor directly to the DC terminals [P(+), N(-)],  
**otherwise fire could occur.**
5. Noise is generated from the drive, motor, and wiring. Take care that this noise does not cause malfunctions in peripheral sensors and equipment,  
**otherwise accidents could occur.**

## Instructions on operation

### **WARNING**

1. Be sure to put on the surface cover before turning the power ON (close).  
Never remove the cover while the power is applied to the drive.  
**Otherwise electric shock could occur.**
2. Never operate switches with wet fingers.  
**Otherwise electric shock could occur.**
3. The interior of the drive may remain charged after turning off the power.  
Therefore, never attempt to remove the surface cover except for wiring service and periodic maintenance.  
**Otherwise electric shock could occur.**

### **WARNING**

1. When the retry function is selected, the drive may automatically restart after tripping, depending on the cause of the trip.  
(Design the machine to secure personal safety in the event of restart.)  
**Otherwise accident could occur.**
2. Operating conditions may occasionally be different from the preset acceleration/ deceleration time or speed because of activation of the stall prevention function.  
In such a case, personal safety must be secured through adequate machine design.  
**Otherwise accident could occur**
3. The stop key is effective only when a function setting has been established.  
Therefore install an emergency switch independently. When operation via the external signal terminal is selected, the STOP key on the keypad panel will be disabled.  
**There is a risk of accidents.**
4. Operation starts suddenly if alarm reset is done with a running signal input. Check that no running signal is input before alarm reset,  
**otherwise accidents could occur.**
5. Never touch the drive terminals when energized even if it has stopped,  
**otherwise electric shock could occur.**
6. Never touch the keys on the keypad panel with a pointed object such as a needle,  
**otherwise electric shock could occur.**

### **CAUTION**

1. Never touch the heat sink because they become very hot,  
**Otherwise burns could occur.**
2. The drive can set high-speed operation easily. Carefully check the limit of the motor and machine before changing the setting,  
**Otherwise injuries could occur.**
3. Do not use the drive brake function for mechanical holding,  
**Otherwise injuries could occur.**



### Instruction on maintenance/inspection, and replacement

#### **WARNING**

1. Do not commence inspection work until at least five minutes after the power has been turned off (open).  
(In addition, make sure that the charge lamp has gone off and check that the DC voltage between terminals P(+) and N(-) does not exceed 25V DC.)  
**Otherwise electric shock could occur.**
2. Only qualified personnel should perform maintenance and inspection or replacement operations.  
(Take off all metal objects (watch, ring, etc.) before starting.)  
(Use well-insulated tools.)  
**Otherwise electric shock or injury could occur.**
3. Never modify the product,  
**otherwise electric shock or injury could occur.**

### Instruction on disposal

#### **CAUTION**

1. Since this product contains lead solder, it must be treated as industrial waste when it is disposed of. Entrust it to a waste processing company when disposing it.

### General instructions

1. The figures in this operation manual may show the drive with covers and safety screens removed to explain the structure in details. Therefore, be sure to replace the covers and screens to their original positions and operate the drive according to the instruction manual.

# Preface

Thank you for purchasing our AF-300C11 series drive. This product is used to drive a 3phase electrical motor at variable speed. Incorrect use of this product may result in personal injury and/or property damage. Read all operating instructions before using this device. Since this manual does not cover the use of option boards, etc., refer to relevant manuals for option operations.

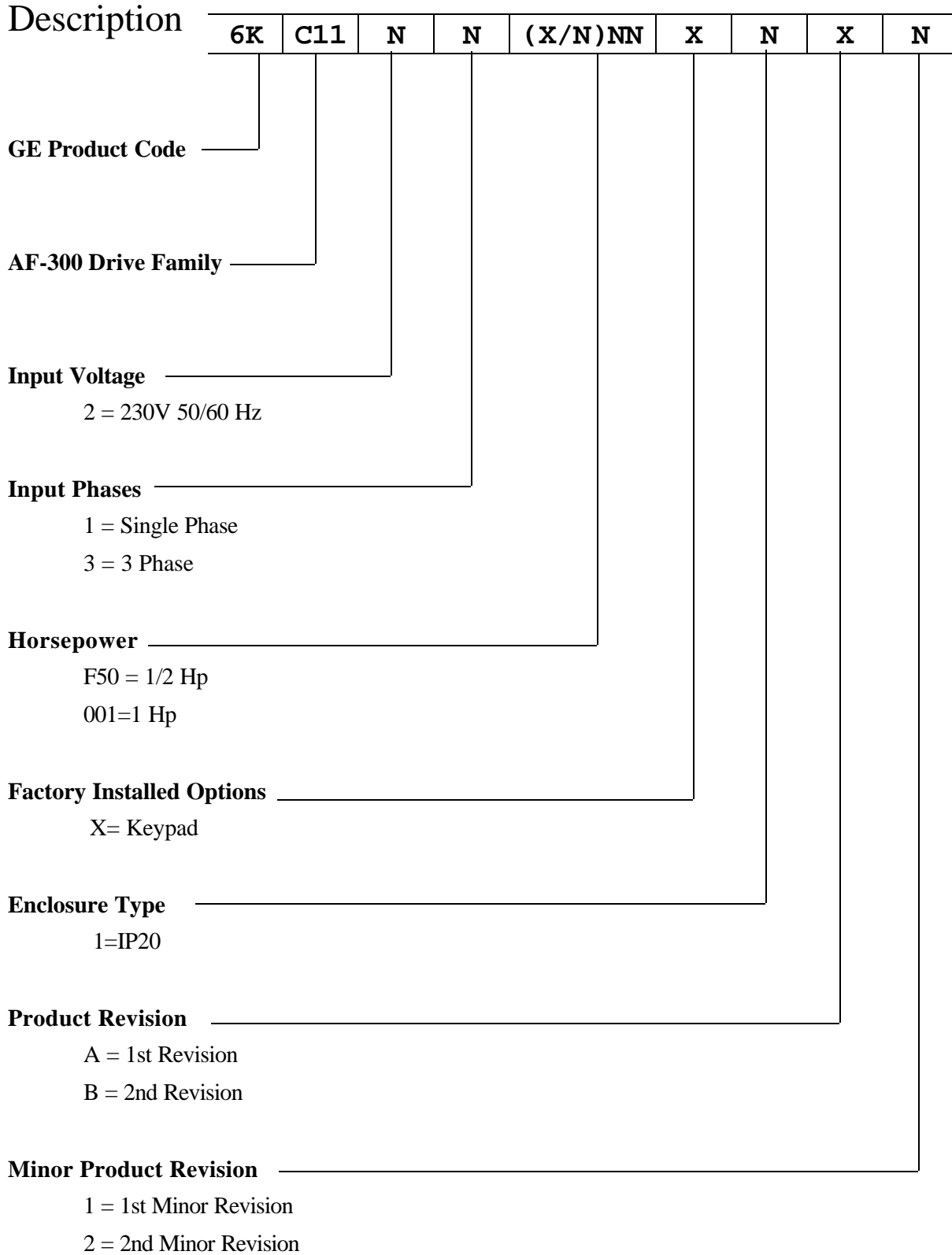
These instructions do not purport to cover all details or variations in equipment, nor to provide for every possible contingency to be met during installation, operation, and maintenance. Should further information be desired or should particular problems arise that are not covered sufficiently for the purchaser's purpose, the matter should be referred to GE Fuji, Technical Service.

NOTE: The terms "inverter", "controller", and "drive" are sometimes used interchangeably throughout the industry. We will use the term "drive" in this document.

AF-300C11 " and XSD" are trademarks of the General Electric Company. Energy Saver is a registered trademark of the General Electric Company.

NOTE: Always read the complete instructions prior to applying power or troubleshooting the equipment and follow all procedures step by step.

# AF-300C11 Model Numbering System Diagram



# AF-300C11

HP Rating	Enclosure	Rated Output Current (A)	Overload (150% 1min.)	AF-300C11 Model No.	Catalog No.	Dimensions H x W x D (inches)	Weight (lbs)
-----------	-----------	--------------------------	-----------------------	---------------------	-------------	-------------------------------	--------------

## 230VAC, 3 phase, 50/60Hz Input

1/8	IP20	0.7	1.1	6KC1123F12X1 **	D5674	4.72 x 3.15 x 3.23	1.3
1/4	IP20	1.4	2.1	6KC1123F25X1 **	D5675	4.72 x 3.15 x 3.43	1.3
1/2	IP20	2.5	3.8	6KC1123F50X1 **	D5676	4.72 x 3.15 x 3.82	1.5
1	IP20	4	6.0	6KC1123001X1 **	D5677	4.72 x 3.15 x 4.80	1.8
2	IP20	7	11	6KC1123002X1 **	D5678	5.12 x 4.33 x 5.55	3.3
3	IP20	10	15	6KC1123003X1 **	D5679	5.12 x 4.33 x 5.55	3.3
5	IP20	16.5	25	6KC1123005X1 **	D5680	7.09 x 5.51 x 5.47	4.9

## 230VAC, Single phase, 50/60Hz Input

1/8	IP20	0.7	1.1	6KC1121F12X1 **	D5668	4.72 x 3.15 x 3.23	1.3
1/4	IP20	1.4	2.1	6KC1121F25X1 **	D5669	4.72 x 3.15 x 3.43	1.3
1/2	IP20	2.5	3.8	6KC1121F50X1 **	D5670	4.72 x 3.15 x 4.61	1.5
1	IP20	4	6.0	6KC1121001X1 **	D5671	4.72 x 3.15 x 5.59	2.0
2	IP20	7	11	6KC1121002X1 **	D5672	5.12 x 4.33 x 5.94	3.5
3	IP20	10	15	6KC1121003X1 **	D5673	7.09 x 5.51 x 5.47	4.9

\*\* Indicates product revision

# 1 Before Using This Product

## 1-1 Receiving Inspections

Unpack and check the product as explained below.

If you have any questions or problems with this product, please contact GE FUJI Drives or your local GE distributor.

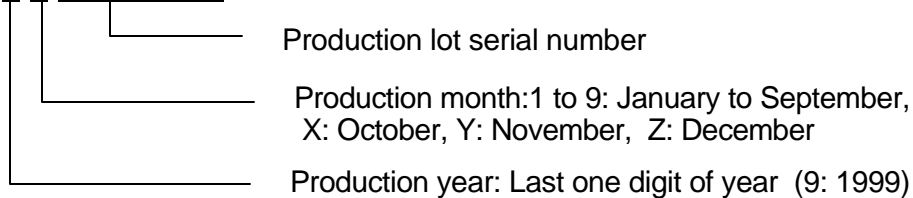
(1) Check the ratings name plate to confirm that the delivered product is the ordered one.



Figure1-1-1 Ratings nameplate

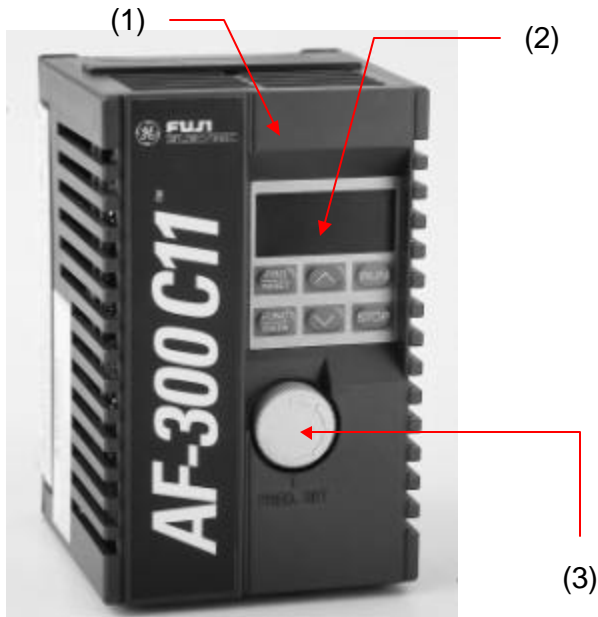
- ① MODEL : Drive Type
- ② INPUT : Number of input phases, rated input voltage, rated input current, rated input frequency
- ③ OUTPUT : Number of output phases, rated output capacity, rated output voltage, output frequency range, rated output current, overload capacity
- ④ SER. No. : Product number

9 9 0528R0001

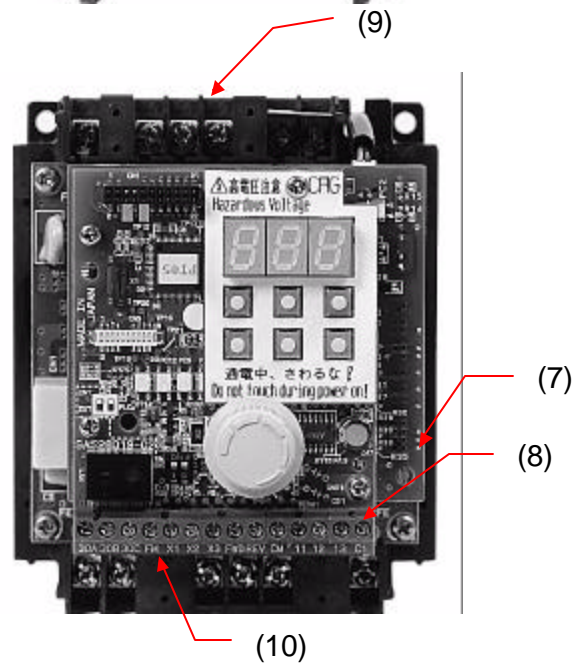
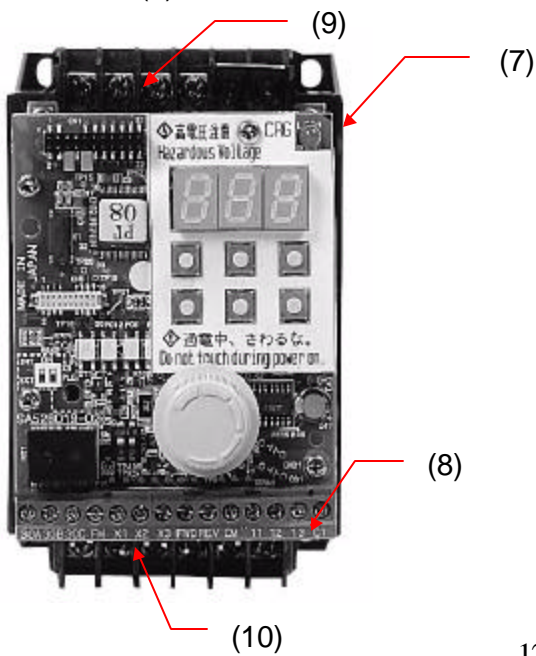
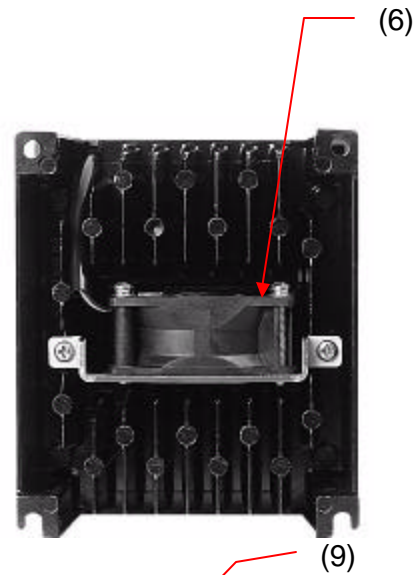
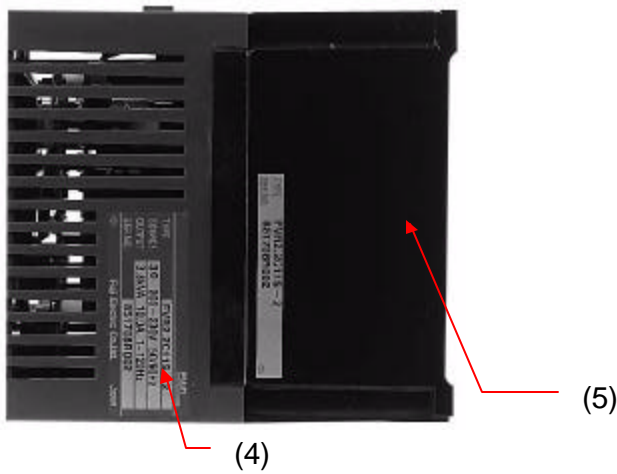


(2) Check for damaged parts, missing parts, and dents or other damage on the covers or the main unit upon delivery.

## 1-2 Appearance



- (1) Surface cover
- (2) Keypad panel
- (3) Frequency setting POT (VR) (built-in POT)
- (4) Ratings nameplate
- (5) Heat sink
- (6) Cooling fan (2 HP or more)
- (7) Charge lamp CRG
- (8) Control terminal block
- (9) Main circuit terminal block  
 3-phase 230V [⚡G, L1/R, L2/S, L3/T, P1, P(+)]  
 Single-phase 230V [⚡G, L1/L, L2/N, P1, P(+)]
- (10) Main circuit terminal block  
 [P(+), N(-), U, V, W, ⚡G]



### 1-3 Handling the Product

Remove the surface cover as explained below.

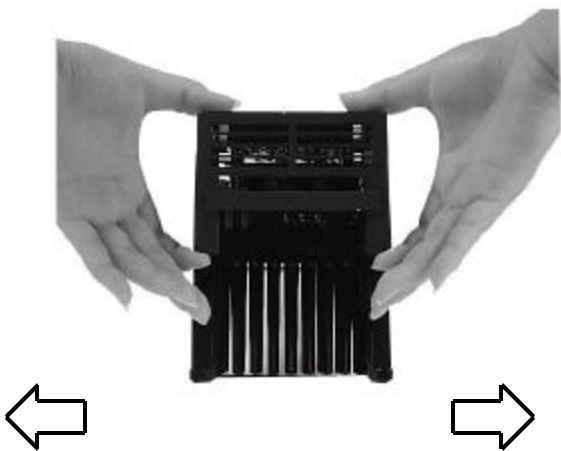
(1) For 1/8 to 1 HP

Grasp the upper and lower parts of the cover with both hands and pull it to the front of the drive.



(2) For 2 to 5 HP

Expand the lower part of the cover horizontally, lift the cover to the front, and then remove it.



#### 1-4 Carrying

Always hold the main unit while carrying this product.

If it is carried by the cover or parts and not the main unit, the product may be damaged or dropped.

Force must not be applied to the drive cover during carrying because it is made of plastic.

#### 1-5 Storage and transportation

Store and transportation this product under the conditions listed in Table 1-5-1.

**Table 1-5-1 Storage and transportation environment**

Item	Specifications	
Storage temperature Transportation temperature	-25 to +65 °C (-4 to +149 °F)	Condensation or formation of ice must not be caused by sudden temperature changes.
Relative humidity	5 to 95% *1	
Atmosphere	The product must not be exposed to dust, direct sunlight, corrosive gas, inflammable gas, oil mist, vapor, water drops, or vibration. There must be no salt in the atmosphere.	
Air pressure	86 to 106kPa (During storage) 70 to 106kPa (During transportation)	

\*1 A large change in temperature within this humidity range may cause condensation or formation of ice. Do not store this product at a place where such changes occur.

#### [Storage precautions]

- ① Do not locate this product directly on a floor; place it on a rack or shelf.
- ② To store the product in a severe atmosphere, pack it in vinyl sheet.
- ③ If the product must be stored at a place where it may be affected by humidity, insert a drying agent such as silica gel and pack it in vinyl sheet.



## 2 Installation and Connection

### 2-1 Operating Environment

Install this product at a place satisfying the conditions listed in Table 2-1-1.

**Table 2-1-1 Operating environment**

Item	Specifications
Place	Indoor
Ambient temperature	-10 to +50 °C (+14 to +122°F)
Ambient relative humidity	5 to 95%RH(No condensation allowed)
Atmosphere	The product must not be exposed to dust, direct sunlight, corrosive gas, inflammable gas, oil mist, vapor, or water drops. There must be no salt in the atmosphere. Condensation must not be caused by sudden changes in temperature.
Altitude	3300 feet (1000m) or less ( Air pressure : 86kPa to 106kPa )
Vibration	3mm: 2 to less than 9Hz 9.8 m/s <sup>2</sup> : 9 to less than 20Hz 2 m/s <sup>2</sup> : 20 to less than 55Hz 1 m/s <sup>2</sup> : 55 to less than 200Hz

### 2-2 Installation Method

- ① Tightly fasten the product in the upright position on a strong structure using four bolts (M4) with the characters AF-300C11 facing the front. Be sure not to turn the product upside down, and install it on a horizontal surface.
- ② Heat is generated while the drive is operating, so the gaps shown in Figure 2-2-1 are necessary for the passage of cooling air. The generated heat is radiated upward by the built-in cooling fan, so do not install this product below a device that is sensitive to heat.
- ③ The temperature of the heat sink increases to about 90 °C while the drive is operating. Therefore, the surface behind where the product is located must be able to withstand this temperature increase.

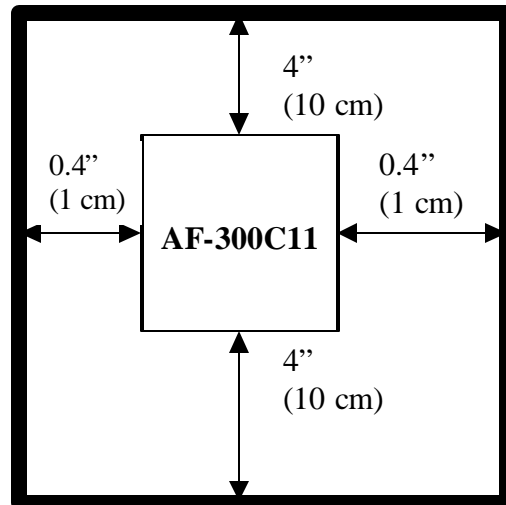


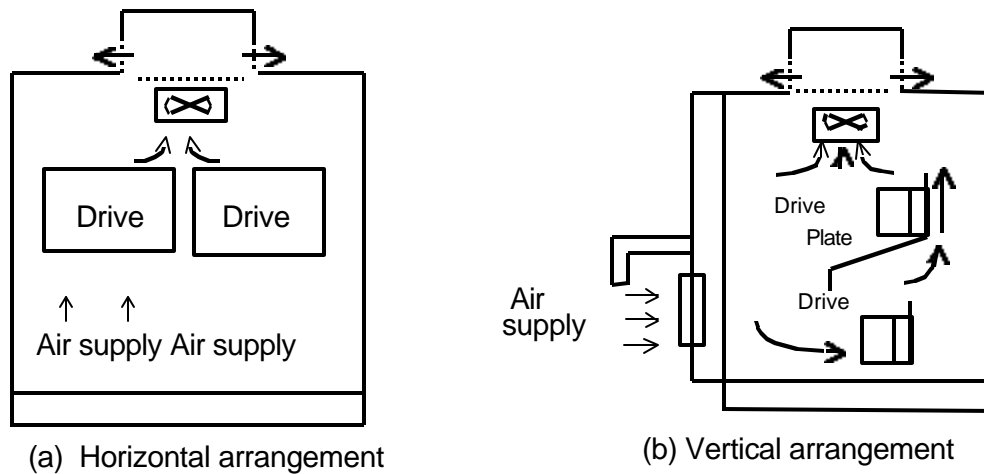
Figure 2-2-1 Installation direction and surrounding space

#### **⚠ WARNING**

Install this product on a nonflammable material such as metal, **otherwise fire could occur.**

- ④ When installing this product in a control panel, carefully consider the ventilation to prevent the ambient temperature of the drive from exceeding the specified value. Do not install it in a hermetically sealed box from which heat is not radiated fully.

- ⑤ If two or more drives need to be installed in the same device or control panel, they should be arranged horizontally to minimize the influence of heat between them. If two or more drives must be installed vertically, place a plate between them to prevent the upper drive from being affected by heat from the lower drive.



**Figure 2-2-2 How to install two or more drives**

<b>⚠ CAUTION</b>	<p>1. Do not allow foreign matter such as lint, paper dust, small chips of wood or metal, and dust to enter the drive or adhere to the heat sink. <b>Otherwise, a disaster such as burning could occur.</b></p>
------------------	---

### 2-3 Connection

Remove the surface cover to connect the terminal blocks. Correctly connect them according to the following procedures.

#### 2-3-1 Basic connection


- ① Always connect the power to the main power supply input terminal of the drive. If it is connected to another terminal, the drive will be damaged (see Figure 2-3-1).
- ② Always ground the ground terminal to prevent disasters such as fire and electric shock and to minimize noise.
- ③ Use a reliable crimp terminal for connection between a terminal and wire.
- ④ After terminating the connection (wiring), check the following items:
  - a. Whether the connection is correct
  - b. Whether all necessary connections have been made
  - c. Whether there is a short-circuit or ground fault between terminals and wires
- ⑤ Connection modification after power-on

The smoothing capacitor in the direct current part of the main circuit cannot be discharged quickly after the power is turned off. Use a multimeter to check that the voltage of the direct current (DC) is reduced to the safety range (25V dc or less) after the charge lamp goes off to avoid danger. Check that the voltage is zero before short-circuiting a circuit because the residual voltage (electric charge) may cause sparks.

<b>⚠ WARNING</b>	<ol style="list-style-type: none"> <li>1. Always connect the ground wire, <b>otherwise electric shock and fire could occur.</b></li> <li>2. Ensure that a licensed specialist performs the wiring work.</li> <li>3. Check before starting the wiring that the power is off, <b>otherwise electric shock could occur.</b></li> </ol>
------------------	---

## 2-3-2 Connecting the main circuit and ground terminals

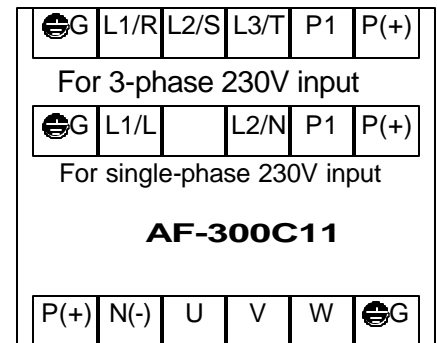
**Table 2-3-1 Functions of main circuit and ground terminals**

Symbol	Name	Explanation
L1/R,L2/S,L3/T	Main power supply input	Connects 3-phase power.(3-phase 230V input)
L1/L,L2/N		Connects single-phase power. (Single-phase 230V input)
U, V, W	Drive output	Connects 3-phase motor.
P1, P(+)	For connection of DC reactor	Connects input power- factor correcting DC reactor (optional).
P(+), N(-)	For DC intermediate circuit	Connected to DC link circuit terminal (for DC bus connection).
 G	For drive grounding	Ground terminal for drive chassis (case).

### (1) Main power supply input terminal

3-phase 230V [L1/R,L2/S,L3/T]  
Single-phase 230V [L1/L,L2/N]

- ① Connect the main power supply input terminals to the power supply via a molded case circuit breaker for circuit protection or earth leakage circuit breaker. An earth-leakage circuit breaker which can also detect DC current is recommended. Phase-sequence matching is unnecessary.
- ② It is recommended that a magnetic contactor is connected to prevent any failure or accident from becoming serious by disconnecting the drive from the power supply when the drive protective function operates.
- ③ Do not turn on or off the main power supply to start or stop the drive; instead, use the control circuit terminal FWD/REV or the RUN/STOP key on the keypad panel. If it is unavoidable to turn the main power supply on or off to start or stop the drive, it must not exceed once per hour.



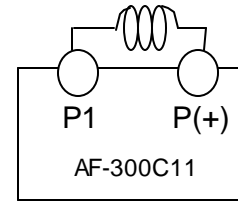
**Figure 2-3-1 Arrangement of main circuit and ground terminals**

### (2) Drive output terminal [U, V, W]

- ① Connect these terminals to the 3-phase motor with the correct phase-sequence. If a motor rotation direction does not correspond to the correct rotation direction, exchange any two of the U, V, and W phases.
- ② Do not connect a phase-advance capacitor or surge absorber to the drive output.
- ③ A very long wiring length between the drive and the motor causes a high frequency current to flow due to floating capacity between cables, making the drive trip, increasing the leakage current and deteriorating the accuracy in the current display. To prevent such trouble, the wiring length to the motor should not exceed 165 feet (50 m).  
When the drive is operated in the low noise mode (carrier frequency: 8 to 15 kHz) and the wiring length is long, add an optional output circuit filter.

(3) DC reactor connecting terminal [P1, P(+)]

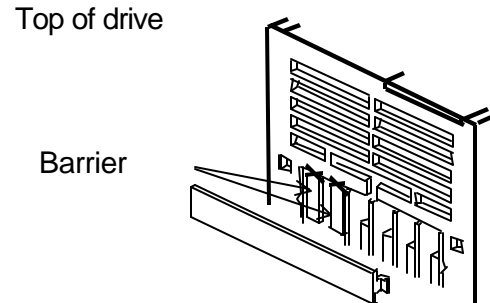
Use this terminal to connect a input power-factor correcting DC reactor (optional). Remove the jumper connected in the factory before connecting the DC reactor (see Figure 2-3-2). Use diagonal cutting pliers to cut the surface cover barriers from P1, P(+) terminals before connection. If no DC reactor is used, do not remove the jumper.



(a) Connection diagram

(4) Drive grounding terminal [G]

Always ground the drive grounding terminal [G] for safety and noise reduction. Grounding of the metal frames of electric equipment has to be done in accordance with the national and local safety specifications in force.



(b) Cutting of barrier

Figure 2-3-2 Connection of DC reactor

- ① Connect a thick and short wire to the grounding terminal of the drive for connection with a ground electrode prepared exclusively for the drive system.

<b>CAUTION</b>	<ol style="list-style-type: none"> <li>1. Check that the number of phases and the rated voltage of this product correspond to the number of phases and voltage of the AC power supply, <b>otherwise fire could occur.</b></li> <li>2. Do not connect the AC power supply to the output terminals (U, V, W), <b>otherwise injury could occur.</b></li> <li>3. Do not connect a braking resistor directly to the DC terminals P(+), N(-), <b>otherwise fire could occur.</b></li> </ol>
----------------	---

2-3-3 Connecting the control terminals

Table 2-3-2 lists the functions of the control circuit terminals.

The method of connecting a control circuit terminal depends on how its function is set. Connect the control circuit terminals according to the set functions.

(1) Digital input terminal

Figure 2-3-3 shows the circuit configuration. Use a reliable contact.

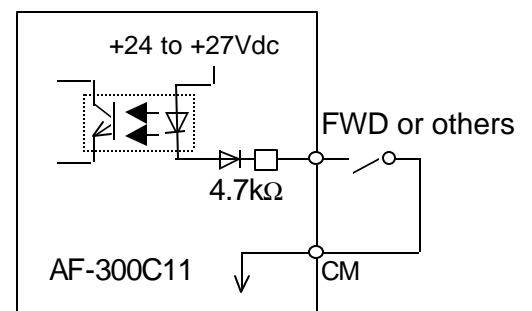



Figure 2-3-3 Digital input terminal

(2) Run/stop command terminal (FWD, REV)

FWD terminal is short-circuit to CM terminal in the factory. Pressing the RUN key on the keypad panel can start forward operation. If function F02 is 0, short-circuit FWD and CM and press the RUN key for forward operation, or short-circuit REV and CM for reverse operation. If function F02 is 1, then short-circuit FWD and CM for forward operation, or REV and CM for reverse operation. Regardless of whether function F02 is set to 0 or 1, short-circuiting both FWD – CM and REV – CM brings the drive to a deceleration-stop. Refer to F02 “Operation method” for details.

(3) Analog input terminal (13, 12, 11, C1)

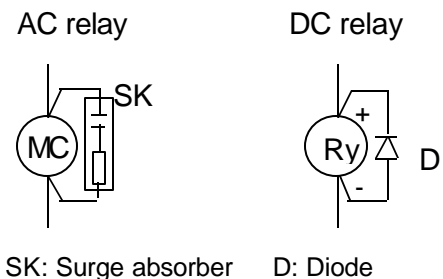
Use these terminals to connect external input analog voltage and analog current and frequency setting device (POT). For connecting a contact to this circuit, use a twin contact for fine current signal. Do not use a contact for terminal 11.

 <b>WARNING</b>	<p>1. The STOP key is valid only when the function has been set. Prepare another switch for emergency stop. When the data of F02 is selecte “2” or “4”, the operation cannot be stopped using the STOP key on the keypad panel, <b>otherwise accidents could occur.</b></p>
--	---

**\*Note the following when wiring:**

(1) Surge absorber connection

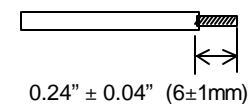
When the exciting coil of the magnetic contactor or relay in the control circuit or drive peripheral circuit is opened or closed, a surge voltage (noise) is generated with a sudden current change. Due to this surge voltage, the drive control circuit or peripheral equipment may malfunction. If so, directly connect a surge absorber to both ends of the coil. (See Figure 2-3-4.)



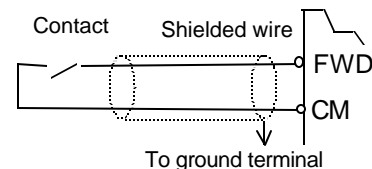
**Figure 2-3-4 Surge absorber connection diagram**

(2) Control circuit wiring

- ① Wires connected to control circuit terminals must be AWG 20 (0.5mm<sup>2</sup>) shielded wire or twisted vinyl wire. Remove the sheath as shown in Figure 2-3-5 and then connect it.
- ② Keep the wiring of the main circuit, external relay sequence circuit and control circuit as far away from each other as possible. If they must be adjacent, cross them at right angles.
- ③ Use a twisted-pair shielded wire for long wiring distances.

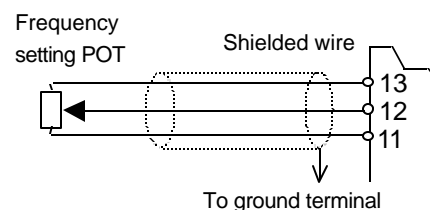


**Figure 2-3-5 End treatment**



(3) Shielding sheath connection

Connect one end of the shielding sheath of a shielded or twisted-pair shielded wire to the ground terminal as shown in Figure 2-3-6. Do not connect the other end.



**Figure 2.3.6 Connection of sheath of shielded wire**

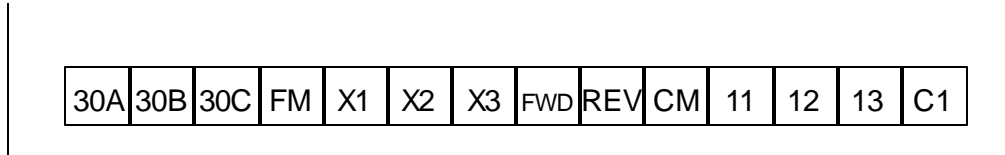
**CAUTION**

1. Noise is generated from the drive, motor, and wiring. Take care that this noise does not cause malfunctions in peripheral sensors and equipment, **otherwise accidents could occur.**

(4) Control terminal arrangement, screw size, and tightening torque

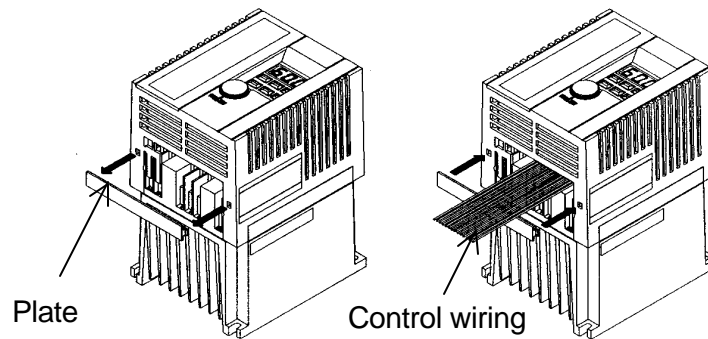
Figure 2-3-7 shows the control terminal block arrangement.

Screw size: M2.5 Tightening torque: 3.5 lb · inch ( 0.4 N· m)



**Figure 2-3-7 Control terminal block arrangement**

(5) Remove the plate at the bottom of the surface cover before performing drive control wiring and reinstall it after the wiring as shown in Figure 2-3-8.



**Figure 2-3-8 How to pull out the control wiring**

**Table 2-3-2 Functions of control circuit terminals**

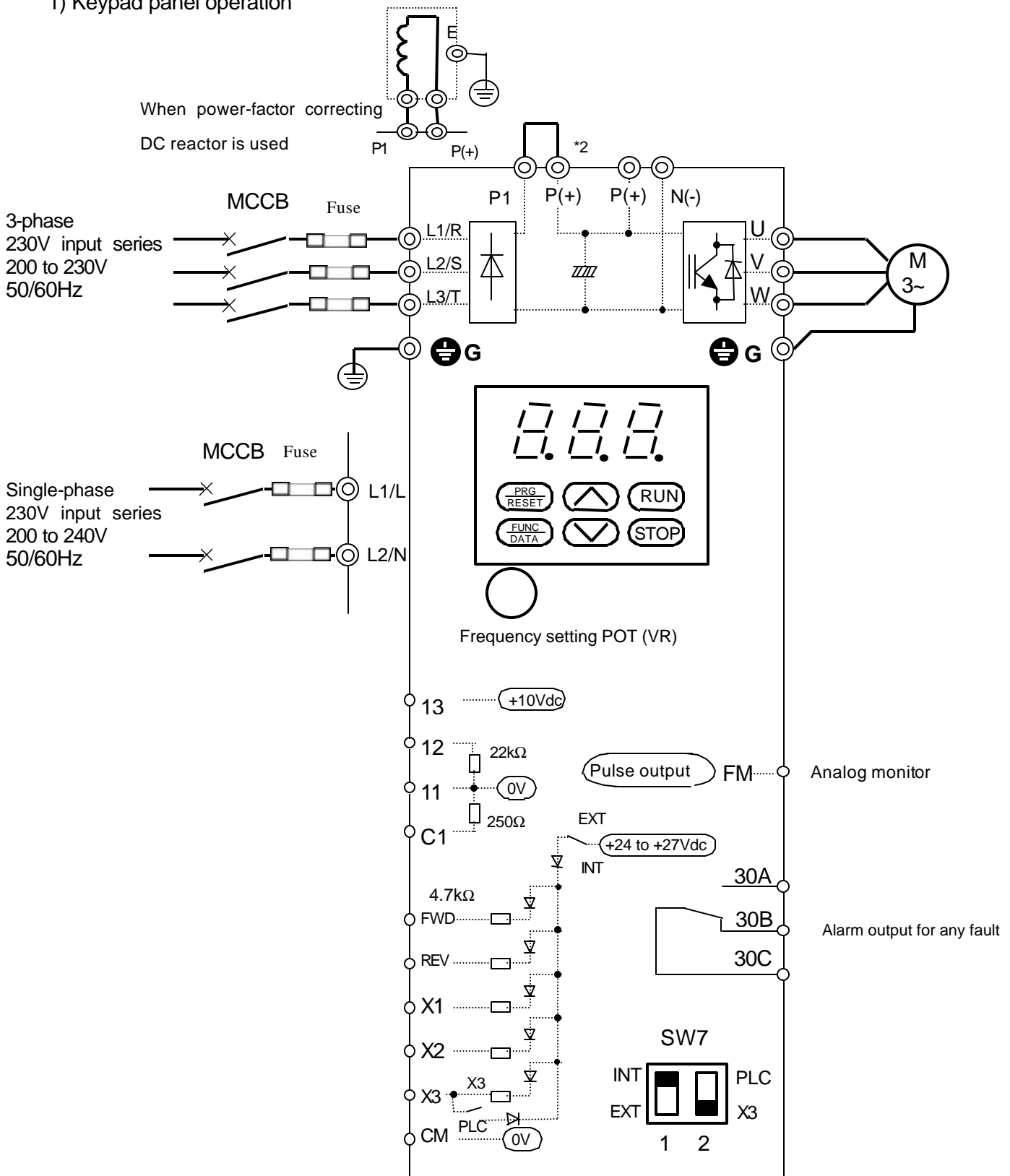
Classification	Terminal symbol	Terminal name	Detailed specifications	Remarks
Analog input	13	Power supply for variable resistor	Used as power supply for frequency setting device (POT: 1 to 5 kΩ). (+10Vdc 10mA max.)	
	12	Frequency setting voltage input	0 to +10Vdc /0 to 100%, 0 to +5Vdc /0 to 100% (Input impedance : 22 kΩ)	
	C1	Frequency setting current input	4 to 20mA dc /0 to 100% (Input impedance : 250 Ω)	
	11	Analog common	Common terminal for analog input signals	
Digital input	FWD	Forward operation /stop command	Forward operation with FWD-CM ON and deceleration-stop with FWD-CM OFF	Deceleration-stop with FWD-CM and REV-CM ON
	REV	Reverse operation /stop command	Reverse operation with REV-CM ON and deceleration-stop with REV-CM OFF	
	X1	Digital input 1	The functions listed below can be set by the X1 to X3 terminal functions.	Set with functions E01 to E03
	X2	Digital input 2		
	X3	Digital input 3		
	(SS1) (SS2)	Multistep frequency selection	Up to four steps speed operation can be selected with SS1 and SS2 ON/OFF signals.	
	(BX)	Coast to stop command	Drive output is cut immediately and the motor coasts to a stop (no alarm output) if BX goes on.	
	(RST)	Alarm reset	The drive releases the status held after stop with an alarm when RST changes from ON to OFF.	
	(THR)	External alarm input	The drive stops with an alarm if THR is set to OFF.	
	(WE-KP)	Write-enable command for keypad (data change allowed)	Data rewriting for each function with the keypad panel is rejected if WE-KP is OFF. Rewriting with keypad panel is allowed if WE-KP is ON.	
	(Hz/PID)	PID control cancel	PID control cancel with Hz/PID ON PID control with Hz/PID OFF	
	(LE)	Link operation selection	Operation based on command from RS485 with LE ON Drive single operation with LE OFF	
	(PLC)	PLC signal power input	Malfunctions due to PLC power failure are prevented.	Switching of X3 terminal with switch SW7
CM	Digital common	Common terminal for digital input signal		

Classification	Terminal symbol	Terminal name	Detailed specifications	Remarks
Analog output	FM, 11	Analog monitor	Data selected between the following items is output with DC voltage: Output frequency PID feedback value Output current DC link circuit voltage * Up to two analog voltmeters (input impedance : 10 kΩ can be connected. Note: Output waveform: An AC pulse is output with consistent frequency and variable duty. The average DC voltage is proportional to output frequency and output current (frequency : 121.6 Hz).	
Contact output	30A 30B 30C	Alarm output for any fault	If the drive is stopped with an alarm, the non-voltage contact signal (SPDT) is output (Contact rating: 250V ac, 0.3 A, Power factor = 0.3) (48V dc, 0.5A for Low-voltage Directive or 42V dc, 0.5A for UL/cUL) Whether an alarm is generated with an exciting operation or non-exciting operation can be switched.	
Optional	DX+ DX-	RS485 RTU communication input/output	Terminal for RS485 communication (when option board is installed) DX+ : Non-inverted signal, DX- : Inverted signal	Installed on optional board.



## 2-3-4 Connection examples

### 1) Keypad panel operation



**Figure 2-3-9 Wiring diagram of keypad panel operation**

- \*1 The RUN and STOP keys on the keypad panel can be used to start and stop the operation and the frequency setting POT (VR) can be used to set a frequency only by connecting the power supply and motor with functions set in the factory. Forward rotation is set in the factory.
- \*2 Remove the jumper between the P1 and P(+) terminals before connecting the optional power-factor correcting DC reactor.
- \*3 Connect the surge absorber in parallel to coils (such as coils of the magnetic contactor and solenoid) near the drive.

## 2) External operation

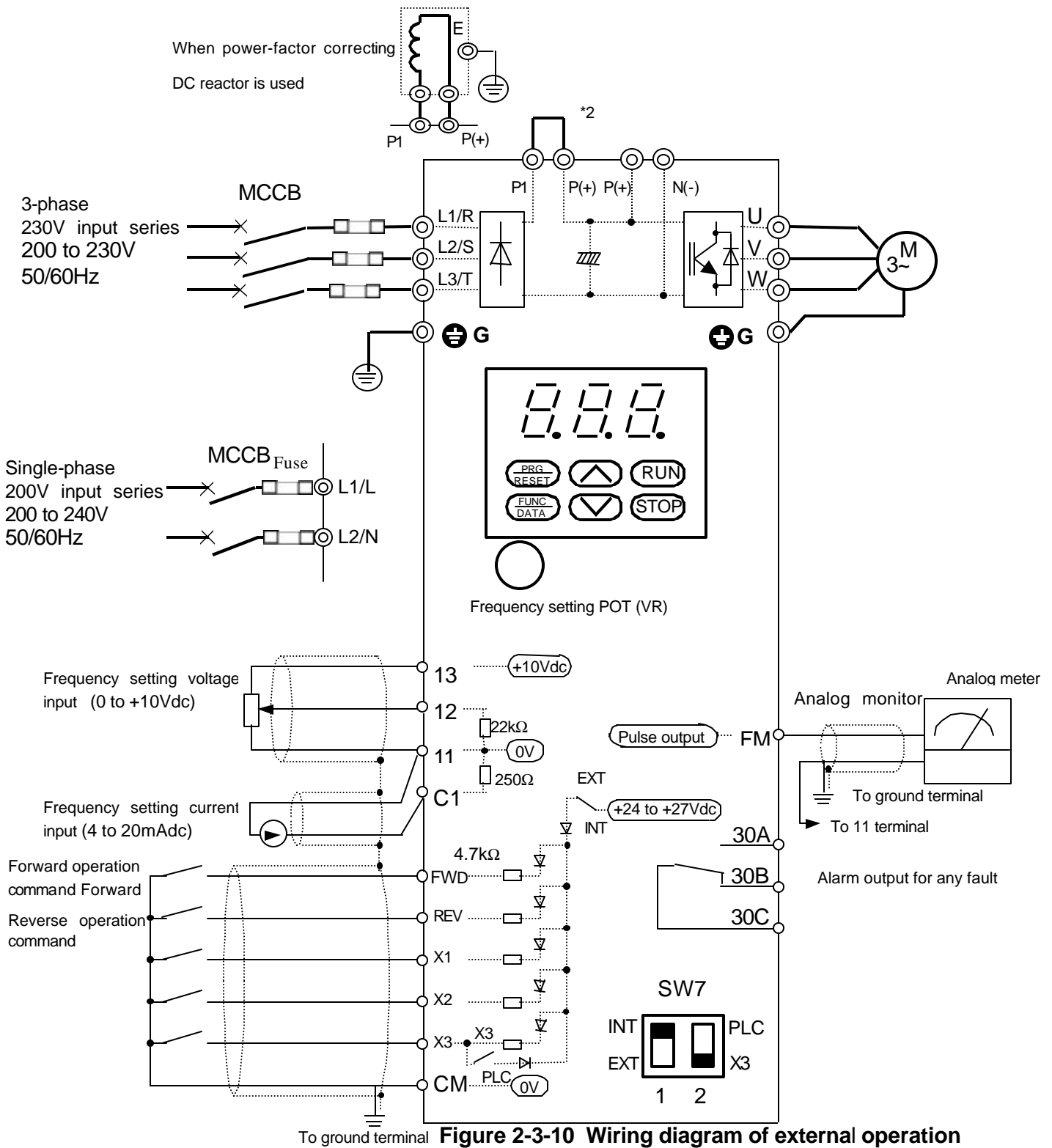
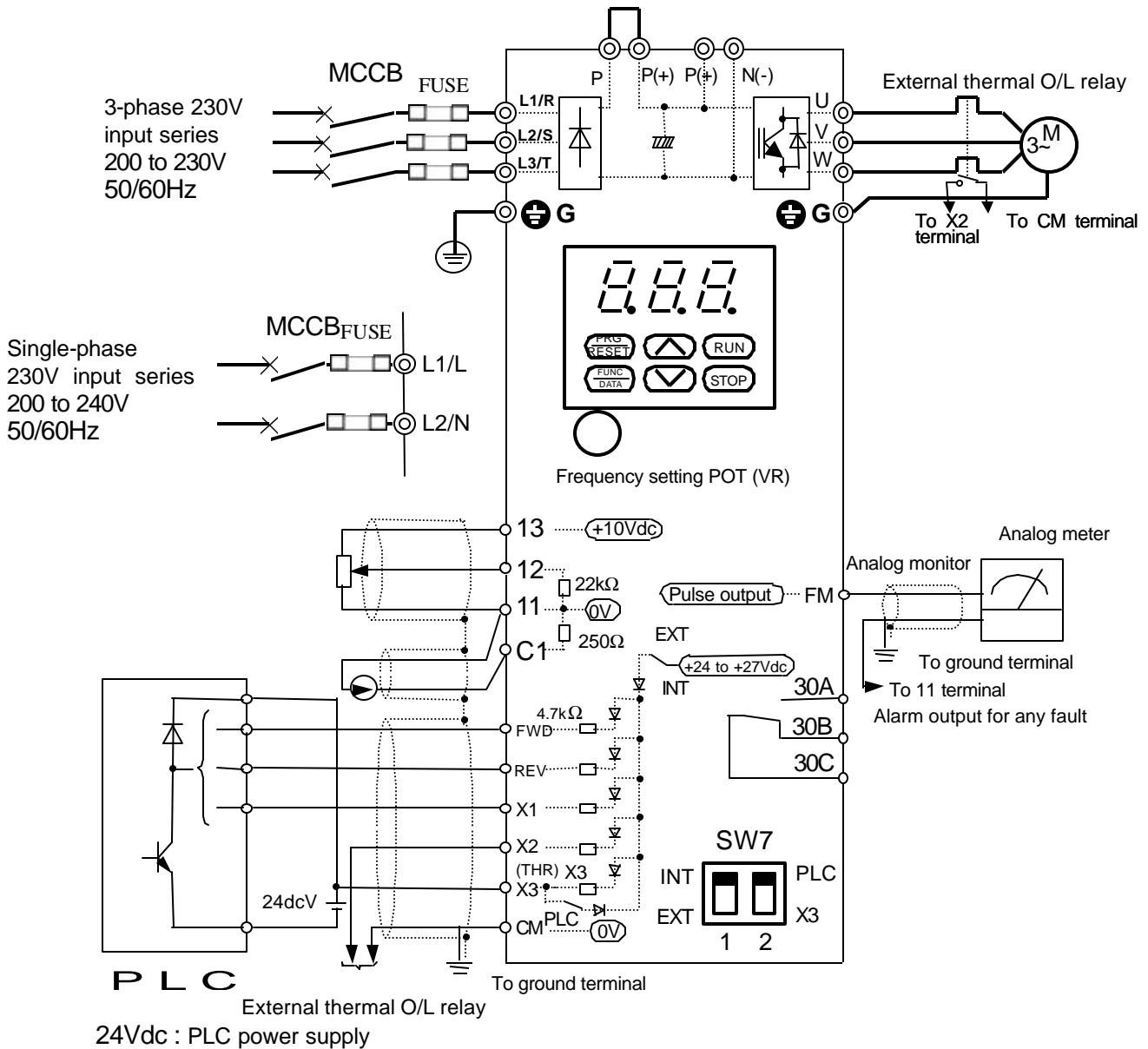


Figure 2-3-10 Wiring diagram of external operation

- \*1 Use this connection to start, stop the operation and set the frequency with external signals. 0 to +10V dc can be set while function F01 is set to 1 and 4 to 20mA can be set while function F01 is set to 2. Set function F02 to 1~4.
- \*2 Remove the jumper between the P1 and P(+) terminals before connecting the optional power-factor correcting DC reactor.
- \*3 Connect the surge absorber in parallel to coils (such as coils of the magnetic contactor and solenoid) near the drive.
- \*4 Use twisted or shielded wire as control signal wire. Connect the shield to the ground terminal.

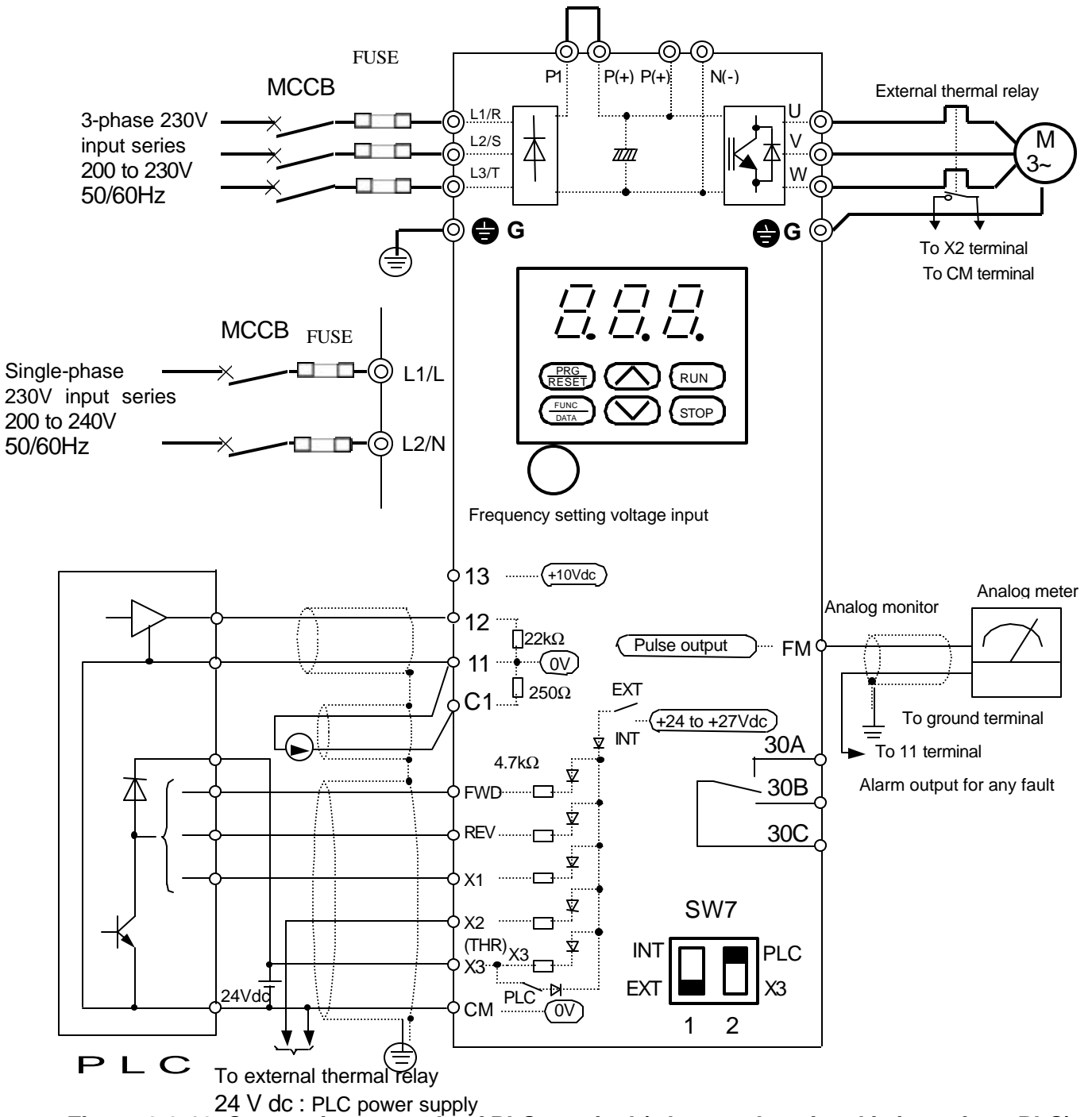
3) Connection to PLC (when external thermal O/L relay is used)



**Figure 2-3-11 Connection example of PLC terminal (using THR function terminal)**

- \*1 Connect the X3 terminal to the PLC power supply of 24Vdc in common and do not connect the CM and 11 terminals to the PLC common. This is to prevent the FWD and REV terminals from turning on due to sneak path current if the PLC power supply is turned off.
- \*2 With this connection, because the internal power of the drive can be supplied to the external thermal O/L relay, OH2 trip is not activated by PLC power-off with the drive turned on.
- \*3 Set SW7 switch 1 to INT and 2 to PLC.
- \*4 When the X3 terminal is used as the PLC terminal, no function that can be set with E03 can be used. The X3 terminal is dedicated to the PLC.

4) Connection to PLC (when analog signal is input from PLC)



**Figure 2-3-12 Connection example of PLC terminal (when analog signal is input from PLC)**

- \*1 When the PLC power supply common may be connected to the drive 11 terminal to input analog frequency setting signals from the PLC, use this connection and set the SW7 switch 1 to EXT and 2 to PLC to prevent the FWD and REV terminals from turning on due to sneak path current when the PLC power is turned off.
- \*2 With this connection, the power is supplied from the PLC power supply to the external thermal O/L relay. So, OH2 trip is activated by PLC power-off with the drive turned on.
- \*3 To prevent drive trip with OH2 when the PLC power being turned off, do not select the THR terminal function and use the drive electronic thermal O/L relay.
- \*4 When the X3 terminal is used as the PLC terminal, no function that can be set with E03 can be used. The X3 terminal is dedicated to the PLC.

## 2-4 Others

### 2-4-1 Harmonic component

A harmonic component which may influence the phase-advance capacitor and generator is included in the drive input current. If necessary, connect a power-factor correcting DC reactor (DCR) (option) for the drive.

### 2-4-2 Noise

When noise generated from the drive may affect peripheral equipment, and noise generated from peripheral equipment may malfunction the drive, the following basic countermeasures should be taken.

1. When noise affects other devices via power and ground wires
  - Separate the ground of the drive and that of the affected device.
  - Connect a noise filter to the drive power wire.
  - Use an isolation transformer to separate the power supply of the drive and that of the affected device.
- 2) When another device is affected by induction or radiation
  - Separate the main circuit wiring of the drive from the control wiring and wiring of the affected device.
  - Encase the drive main circuit wiring in a metal tube and ground the metal tube near the drive.
  - Encase the drive in a metal rack and ground the rack.
  - Connect a noise filter to the drive power wire.
- 3) When noise generated from peripheral equipment affects the drive
  - Use twisted or twisted-pair shielded wires for the drive control wiring. Ground the shields.
  - Connect a surge absorber in parallel to the coil of the magnetic contactor and solenoid.
  - If the power supply includes much distortion of the waveform or surge, connect an impedance matching AC reactor for coordination of power supply.

### 2-4-3 Leakage current

Leakage current flows through the drive I-O wiring and motor stray capacitance when the drive transistor is turned on and off. Table 2-3-3 lists the countermeasures for the problems caused by the leakage current.

**Table 2-3-3 Countermeasures for leakage current**


	Problem	Countermeasures
1	Trip of earth leakage circuit breaker on main power supply side	Set the carrier frequency lower. Shorten the wiring between the drive and motor. Increase the ELCB/RCD sensitivity current. Replace the ELCB/RCD with an ELCB/RCD that is designed for high frequencies.
2	Trip of external thermal O/L relay	Set the carrier frequency lower. Increase the thermal O/L relay set value. Use the drive electronic thermal O/L relay.

### 3 Operation

#### 3-1 Inspection and Preparation before Operation

Check the following before operation:

(1) Check whether the connection is correct,

For 3-phase 230V series, check whether the power supply is connected correctly to the L1/R, L2/S and L3/T terminals. For single-phase 230V series, check whether the power supply is connected correctly to the L1/L and L2/N terminals. Also check whether the drive grounding terminal G is securely connected.

(2) Check for short-circuits and ground faults between terminals and between live parts.


(3) Check for loose terminals, connectors, and screws.

(4) Check whether the motor is separated from mechanical equipment.

(5) Set switches to OFF before turning on the power so that the drive will not start or operate abnormally at power-on.

(6) Check the following after power-on:

a) Check for alarms displayed on the keypad panel.

 <b>WARNING</b>	<ol style="list-style-type: none"> <li>1. Always install the surface cover before turning on the power. Do not remove the surface cover during conduction,</li> <li>2. <b>otherwise electric shock could occur.</b></li> <li>3. Do not operate a switch with wet hands, <b>otherwise electric shock could occur.</b></li> </ol>
---	---

#### 3-2 Operation Method

There are various operation methods. Select a method depending on the purpose and operation specifications with reference to Chapters 4 and 5. Table 3-2-1 lists operation methods used generally.

**Table 3-2-1 General operation method**

Operation method	Frequency setting	Running command
Operation by using keypad panel	Built-in frequency setting POT (VR) or UP/DOWN key	RUN/STOP key
Operation by using external signal terminal	Setting by using analog voltage, analog current, and external POT (VR)	Contact input (switch) Terminal FWD-CM or REV-CM

### 3-3 Trial Run

The motor rotates when a frequency value and running command are input from the keypad panel or external signal terminal. Refer to Table 3-3-1.

Use a low frequency (about 5Hz) for trial runs

A frequency can be set using the built-in frequency setting POT (VR) , and forward/stop can be performed using the keypad panel with the functions set in the factory.

**Table 3-3-1 Running command**

Operation method	Frequency setting	Running command
Operation by using keypad panel	(When built-in POT (VR) is used) The frequency increases when the variable resistor is turned clockwise and reduces when it is turned counterclockwise. The motor accelerates when the variable resistor is turned clockwise during operation and decelerates when it is turned counterclockwise.	Operation starts when the RUN key is pressed. The motor decelerates and stops when the STOP key is pressed.
Operation by using external signal terminal	(When the UP/DOWN key is used) Frequency increases when the UP key is pressed. It reduces when the DOWN key is pressed.	Operation starts when FWD (REV) terminal is connected. The motor decelerates and stops when the FWD (REV) terminal is disconnected. * Operation is not stopped although the STOP key is pressed. (When the data of F02 is set to "2" or "4")

Check the following items:



- a) Rotation direction
- b) Whether rotation is smooth (whether there is a motor buzzing noise or abnormal vibration)
- c) Whether acceleration and deceleration are smooth
- d) Whether the drive cooling fan is rotating (1.5kW or more)

If no abnormality is detected, check the item again by increasing the frequency.

Even if the output from the drive is stopped, you will be get an electric shock when you touch the main circuit terminals such as drive output terminals U, V and W if the voltage is supplied to the main power supply input terminal.

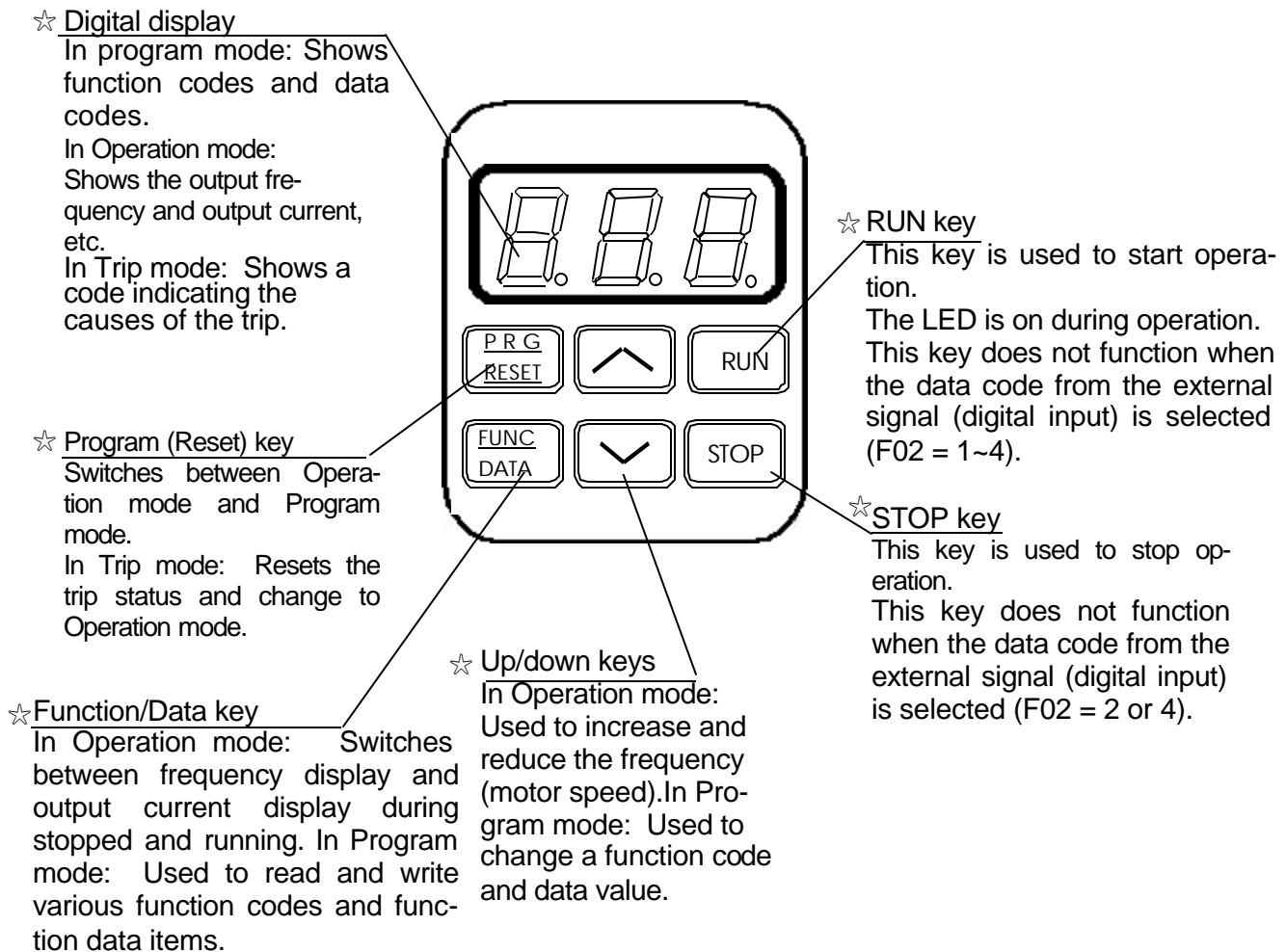
The smoothing capacitor in the drive has been charged when the power is turned off and it is not discharged immediately. Before touching the electric circuit, wait until at least five minutes have elapsed after power-off and the charge lamp is off, indicating the voltage is already low.

After checking normality in the above trial run, start operation.

 <b>WARNING</b>	<ol style="list-style-type: none"> <li>The STOP key is valid only when the function has been set. Assign another switch to emergency stops, <b>otherwise accidents could occur.</b></li> <li>Operation starts suddenly if alarm reset is done with an running signal input. Check that no running signal is input before alarm reset, <b>otherwise accidents could occur.</b></li> </ol>
 <b>CAUTION</b>	<ol style="list-style-type: none"> <li>Do not touch the heat sink, <b>otherwise burns could occur.</b></li> </ol>

## 4 Keypad Panel

### 4-1 Names and Functions

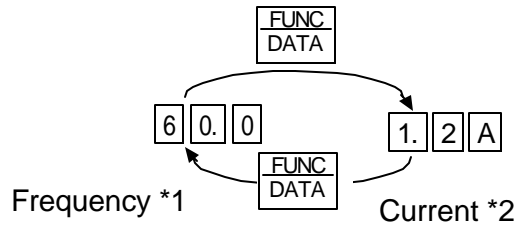




## 4-2 Operating Keypad Panel

### 1) Switching monitor

The display can be switched between frequency display and output current display by pressing the **FUNC DATA** in Operation mode.



\*1 Frequency is displayed as a percentage with the least significant digit in PID control operation (function H20 is set to 1 or 2):

1 0. 0 for 10%

1 0 0. for 100%

\*2 The reference frequency is displayed when the **△** key is pressed in current indication.

### 2) Stopping operation

Operation is started when the **RUN** is pressed, and is stopped when the **STOP** is pressed while function **F02** is set to **000**, **001**, or **003**.

The rotation direction is:


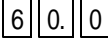










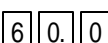
Forward rotation with FWD-CM ON, and reverse rotation with REV-CM ON





### 3) Changing frequency

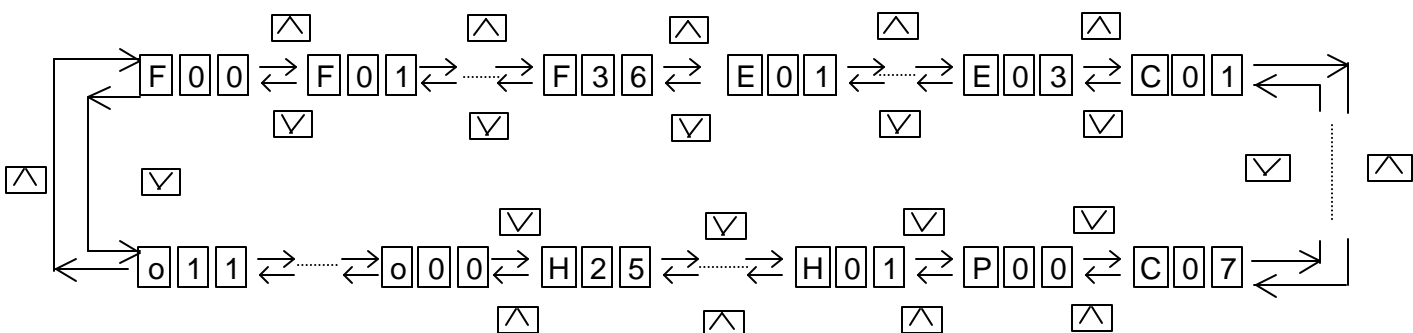
The frequency increases when the **△** is pressed and decreases when the **▽** is pressed while function **F01** is set to **000**.

The change speed is increased when the **FUNC DATA** is pressed at the same time as the **△** or **▽**.

Note: Do not turn the power off for five seconds after monitor switching or function setting, to prevent Er1 occurrence.

	Procedure	Display
1	Press the  key to set the program mode.	 
2	Press the  key to select a function.	 *
3	Press the  key to display data.	
4	Press the  key to change the data.	
5	Press the  to save the data.	
6	Changing another function Press the  to cancel the program mode.	

\* The function code display changes as shown below. The  to  are displayed only with  set to .



## 5 Selecting Function

### 5-1 Function Selection List

Table 5-1-1 Table of Function Selection List

#### F: Fundamental functions

Function code No.	Name	Setting range	Unit	Min. unit	Factory setting	Change during operation	User setting
F00	Data protection	0: Data change enabled, 1: Data protected	-	-	0	N	
F01	Frequency command	0:Key operation ( $\frac{\Delta}{\nabla}$ key) 1:Voltage input (terminal [12]) (0 to +10Vdc, 0 to +5Vdc) 2:Current input (terminal[C1]) (4 to 20mAdc) 3:Voltage input + current input (terminals[12]+[C1]) 4:Analog (VR built in drive)	-	-	4	N	
F02	Operation method	0: Keypad operation 1: Terminal operation (STOP key active) 2: Terminal operation (STOP key inactive) 3: Terminal operation (STOP key active) with GE software 4: Terminal operation (STOP key inactive) with GE software	-	-	0	N	
F03	Maximum output frequency	50 to 120Hz	Hz	1	60	N	
F04	Base frequency	25 to 120Hz	Hz	1	60	N	
F05	-	Data cannot be changed.	-	-	0	-	
F06					0		
F07	Acceleration time	0.0 to 60.0s 0.01 second is set when 0.0 is specified.	s	0.1	6.0	Y	
F08	Deceleration time	0.1 to 60.0s	s	0.1	6.0	Y	
F09	Torque boost	0,1 : Variable torque characteristic 2 to 31: Constant torque characteristic	-	1	13	Y	

Change during operation: N = impossible, Y\* = possible (enabled by using  $\frac{\text{FUNC}}{\text{DATA}}$ ), Y = possible (enabled by using  $\frac{\Delta}{\nabla}$ )

Function code No.	Name	Setting range	Unit	Min. unit	Factory setting	Change during operation	User setting
F10	Electronic thermal overload relay (Select)	0:Inactive 1:Active (for 4-pole standard motor) 2:Active (for 4-pole forced air motor)	—	—	1	Y*	
F11	(Level)	20 to 135% of drive rated current	A	0.01	Typical value of GE 4-pole motor	Y*	
F12	(Thermal time constant)	0.5 to 10.0min	min	0.1	5.0	Y*	
F14	Restart after momentary power failure	0:Inactive (Trip and alarm when power failure occurs) 1:Inactive (Trip and alarm when power recovers) 2:Active (Momentarily stops and restarts at setting frequency of before power failure) 3:Active (Momentarily stops and restarts at starting frequency)	—	—	0	N	
F15	Frequency limiter (High)	0 to 120Hz	Hz	1	70	Y	
F16	(Low)	0 to 120Hz			0	Y	
F17	Gain (for frequency setting signal)	0: For 0 to +10Vdc, 1: For 0 to +5Vdc	—	—	0	N	
F18	Bias frequency	-120 to 120Hz	Hz	1	0	Y	
F20	DC injection brake (Starting freq.)	Fixed to 3Hz	Hz	—	3.0	—	
F21	(Braking level)	0 to 100%	%	1	0	Y	
F22	(Braking time)	0.0 s (Inactive), 0.1 to 30.0 s	s	0.1	0.0	Y	
F23	Starting frequency	1 to 6Hz	Hz	1	1	N	
F24	—	Data cannot be changed.	—	—	0.0	—	
F25	Stop frequency	1 to 6Hz	Hz	1	1	N	
F26	Motor sound (carrier freq.)	0 to 15kHz 0.75kHz is set when 0 is specified	kHz	1	2	Y	
F27	(sound tone)	0: Level 0    1: Level 1 2: Level 2    3: Level 3					—
F30	FM terminal (Voltage adjust)	0 to 200%	%	1	100	Y	
F31	(Function)	0: Output frequency 1: Output current 2: PID feedback amount 3: DC link circuit voltage	—	—	0	Y*	
F36	30Ry operation mode	0: Excited when tripped 1: Normally excited	—	—	0	N	

Change during operation: N = impossible, Y\* = possible (enabled by using 

FUNC
DATA

), Y= possible (enabled by using 

△
▽

)

### E: Extension Terminal Functions

Function code No.	Name	Setting range	Unit	Min. unit	Factory setting	Change during operation	User setting
E01	X1 terminal function	Use the code values listed below to select [X1], [X2] and [X3] terminal functions.	–	–	0	N	
E02	X2 terminal function		–	–	2	N	
E03	X3 terminal function		–	–	3	N	
		0: Multistep frequency 1 (SS1) 1: Multistep frequency 2 (SS2) 2: Coast-to-stop command (BX) 3: Alarm reset (RST) 4: External alarm (THR) 5: Write enable command for keypad (WE-KP) 6: PID control cancel (Hz/PID) 7: Link operation selection (LE)					

### C: Control Functions of Frequency

Function code No.	Name	Setting range	Unit	Min. unit	Factory setting	Change during operation	User setting
C01	Jump frequency 1	0 to 120Hz	Hz	1	0	Y	
C02				2	0	Y	
C03				3	0	Y	
C04	(Hysteresis)	0 to 30Hz	Hz	1	3	Y	
C05	Multistep frequency	0.0 to 120Hz	Hz	1	0.0	Y	
C06				2	0.0	Y	
C07				3	0.0	Y	

Change during operation: N = impossible, Y\* = possible (enabled by using  $\frac{\text{FUNC}}{\text{DATA}}$ ), Y = possible (enabled by using  $\triangle \nabla$ )

### P: Motor Parameters

Function code No.	Name	Setting range	Unit	Min. unit	Factory setting	Change during operation	User setting
P00	Motor characteristics	0 to 10	—	—	2	Y	

### H: High Performance Functions

Function code No.	Name	Setting range	Unit	Min. unit	Factory setting	Change during operation	User setting
H01	Operation time	Operation time accumulation	100Hr	1	0	—	
H02	Trip history	The contents of the last four alarms are displayed sequentially.	—	—	---	—	
H03	Data initialization	1: Initialized (return to factory setting value)	—	—	0	N	
H04	Auto-reset	0: Inactive 1: Active (5 times fixed)	—	—	0	Y*	
H06	Fan Stop Operation	0: Inactive 1: Active	—	—	0	Y*	
H20	PID control (Mode select)	0: Inactive 1: Active (Normal operation) 2: Active (Inverse operation)	—	—	0	N	
H21	(Feedback signal)	0: Terminal [12] (0 to +10Vdc) Input 1: Terminal [C1] (4 to 20mA dc) Input 2: Terminal [12] (+1 to +5Vdc) Input	—	—	1	N	
H22	(P-gain)	0.01 to 10.0 times (1 to 1000%)	—	0.01	0.01	Y	
H23	(I-gain)	0.0s : Inactive 0.1 to 999s	s	0.1	0.0	Y	
H24	(D-gain)	0.00s : Inactive 0.01 to 10.0s	s	0.01	0.00	Y	
H25	(Feedback filter)	0.0 to 60.0s	s	0.1	0.5	Y	

Change during operation: N = impossible, Y\* = possible (enabled by using 

FUNC
DATA

), Y= possible (enabled by using 

△
▽

)

### O: Optional Functions

Function code No.	Name	Setting range	Unit	Min. unit	Factory setting	Change during operation	User setting
o00	RTU Option	0 : Inactive 1 : Active	-	-	0	Y*	
o01	Address	1 to 247 (Max – 31 Drives)			1	Y*	
o02	Mode select on no response error	0 : Er8 by 8 times communication/checksum errors 1 : Er8 by 8 times communication/checksum errors 2 : Er8 with no communication more than timer (o03) 3 : Retry and keep running			0	Y*	
o03	Timer	1 to 60 s	s	1	2	Y*	
o04	Baud rate	1 : 9600      2 : 4800 3: 2400	-		1	Y*	
o05	Data length	0 : 8 bits (Fixed)	-		0	Y*	
o06	Parity check	0 : No checking 1 : Even parity,    2 : Odd parity	-		0	Y*	
o07	Stop bits	0 : 2bits      1 : 1bit (Automatically changed by o06 setting)	-		0	Y*	
o08	No response error detection time	0 : (No detection) 1 to 60 s	s	1	0	Y*	
o09	Response interval	0.00 to 1.00 s	s	0.1	0.01	Y*	
o10	RTU Frequency Command	0 : F01 setting is active 1 : RTU setting is active	-		0	N	
o11	RTU Operation Command	0 : F02 setting is active 1 : RTU setting is active	-		0	N	

**Note:** For details on “o01” to “o11”, refer to the instruction manual that came with the optional RS485 RTU serial communication option.

## 5-2 Details of Each Function

F00

Data protection

Factory setting	Change during operation
0	N

Set data can be locked to prevent it from being changed by mistake when using the keypad panel:

		0
--	--	---

 Data can be changed.

		1
--	--	---

 Data is protected.

Data is changed when the 

STOP
------

 + 

▲
---

 or 

▼
---

 key are pressed simultaneously.

F01

Frequency command

Factory setting	Change during operation
4	N

The following five values can be selected:

		0
--	--	---

 Key operation [

▲
▼

 key]

		1
--	--	---

 Voltage input (terminal 12) (0 to + 10Vdc)

		2
--	--	---

 Current input (terminal C1) (4 to 20mA)

		3
--	--	---

 Voltage input (terminal 12) + current input (terminal C1)

		4
--	--	---

 Analog setting (POT built in drive)

### ⚠ CAUTION

High-speed operation can be set by the drive easily. Carefully check the limit of the motor and machine before changing the setting,

**otherwise injuries could occur.**



**F02** Operation method

Factory setting	Change during operation
0	N

The following four values can be selected:

0 Keypad operation [  RUN  STOP key]

The motor runs when the  RUN key is pressed and decelerates-to-stop when the  STOP key is pressed. The rotation direction depends on the FWD and REV terminals as follows:

FWD - CM short-circuited: Forward

REV - CM short-circuited: Reverse

Operation is impossible when both the FWD and REV terminals or none of them are short-circuited with the CM terminal.

1 External signal (Digital input) (FWD, REV)

Forward operation with FWD-CM short-circuited and deceleration to stop with them open

Reverse operation with REV-CM short-circuited and deceleration to stop with them open

No operation with both FWD-CM and REV - CM short-circuited

STOP key active (See following page chart for detail)

2 External signal (Digital input) (FWD, REV)

Forward operation with FWD-CM short-circuited and deceleration to stop with them open

Reverse operation with REV-CM short-circuited and deceleration to stop with them open

No operation with both FWD-CM and REV - CM short-circuited

STOP key inactive (See following page chart for detail)

3 External signal (Digital input) (FWD, REV)

Forward operation with FWD-CM short-circuited and deceleration to stop with them open

Reverse operation with REV-CM short-circuited and deceleration to stop with them open

No operation with both FWD-CM and REV - CM short-circuited

STOP key active with GE start software (See following page chart for detail)

4 External signal (Digital input) (FWD, REV)

Forward operation with FWD-CM short-circuited and deceleration to stop with them open

Reverse operation with REV-CM short-circuited and deceleration to stop with them open

No operation with both FWD-CM and REV - CM short-circuited

STOP key inactive with GE start software (See following page chart for detail)

**Note: This function can be changed only while the FWD and REV terminals are open.**

Change during operation: N = impossible, Y\* = possible (enabled by using 

FUNC
DATA

), Y= possible (enabled by using 

△
▽

)

### GE START SOFTWARE SELECTION DURING TERMINAL OPERATION

	Inactive : Setting 1 or 2	Active : Setting 3 or 4
<b>POWER ON</b>		
<b>RESET</b>		
<b>NETWORK MODE</b>		

NOTE) Safety software does not work at AUTO RESET mode and PRGRAMMING mode.

### STOP KEY MODE SELCTION DURING TURMINAL OPERATION

	Inactive : Setting 2 or 4	Active : Seeting 1 or 3
<b>STOP KEY</b> (Terminal mode)		
<b>STOP KEY</b> (Network mode)		

Change during operation: N = impossible, Y\* = possible (enabled by using 

FUNC
DATA

), Y= possible (enabled by using 

△
▽

)

F03

### Maximum output frequency

Factory setting	Change during operation
60Hz	N

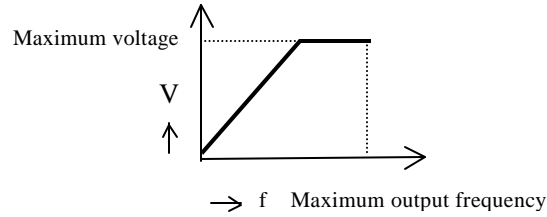
This function sets the maximum output frequency.

	5	
--	---	--

to

1	2	
---	---	--

The maximum output frequency can be set with a resolution of 1 Hz in a range between 50 and 120 Hz.



<b>⚠ CAUTION</b>
High-speed operation can be set by the drive easily. Carefully check the limit of the motor and machine before changing the setting, <b>otherwise injuries could occur.</b>

Change during operation: N = impossible, Y\* = possible (enabled by using 

FUNC
DATA

), Y= possible (enabled by using 

△
▽

)

**F04** Base frequency

Factory setting	Change during operation
60Hz	N

This function sets a base frequency (branch point between constant torque characteristic and constant output characteristic).

	2	5
--	---	---

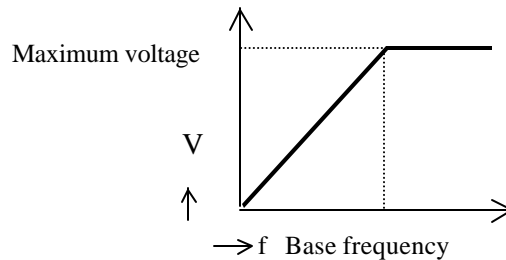
  
to  

1	2	0
---	---	---

The base frequency can be set with a resolution of 1 Hz in a range between 25 and 120 Hz.

Set a frequency matching the motor characteristics.

A value exceeding the maximum frequency can be set but the output voltage is reduced.



**F05**

Factory setting	Change during operation
0	N

**F06**

Data cannot be changed.

**F07** Acceleration time

Factory setting	Change during operation
6.0	Y

	0	0
--	---	---

  
to  

6	0	0
---	---	---

The time taken to increase from 0.0 Hz to the maximum output frequency can be set in an increment of 0.1 s step in a range between 0.0 and 60.0 s.

0.01 is set when 0.0 is specified.

**F08** Deceleration time

Factory setting	Change during operation
6.0	Y

	0	1
--	---	---

  
to  

6	0	0
---	---	---

The time taken to increase from the maximum output frequency to 0.0 Hz can be set in a range between 0.1 and 60.0 s. (In an increment of 0.1 s step)

F09

Torque boost

Factory setting	Change during operation
13	Y

This function can choose between 32 types of boost according to the load type and motor characteristics.

0

to

1

2

to

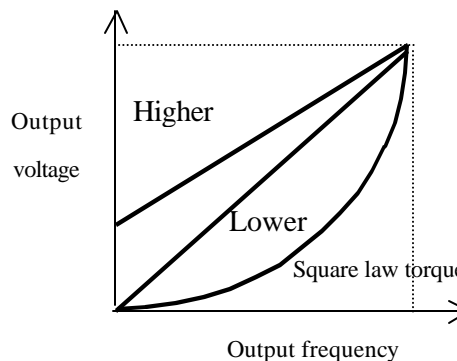
3  1

For square law torque loads  
(fan, pump)

Lower

↓

Higher



F10

Electronic thermal O/L relay (Select)

Factory setting	Change during operation
1	Y*

This function is used to select between the following three values:

0 Inactive

1 Active ······ 4-pole standard motor

2 Active ······ 4-pole forced air motor

F11

Electronic thermal O/L relay(Level)

Factory setting	Change during operation
Motor rated	Y*

1  4

to

2  3

This function sets the operation level of an electronic thermal O/L relay by using an ampere value according to the motor rated current.

20 to 135% of the drive rated current can be set.

Values less than 9.99A can be set in 0.01A step and values more than 10.0A can be set in 0.1A step.

Set the value obtained by multiplying the motor rated current by coefficient K in the table below according to the wiring length between the drive and motor.

Drive HP	Wiring length		
	0'	132'	165' Max. 330'
1/8	K=1.2	External thermal is recommended.	
1/4	K=1	K=1.1	
1/2 to 5	K=1		

**F12** Electronic thermal O/L relay (thermal time constant)

Factory setting	Change during operation
5.0min	Y*

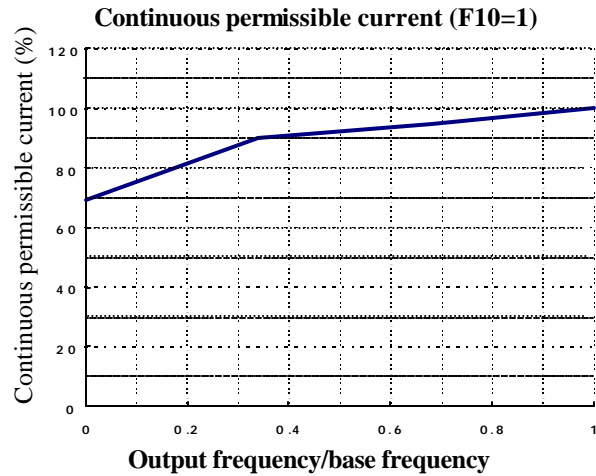
0.	5
----	---

  
 to
   

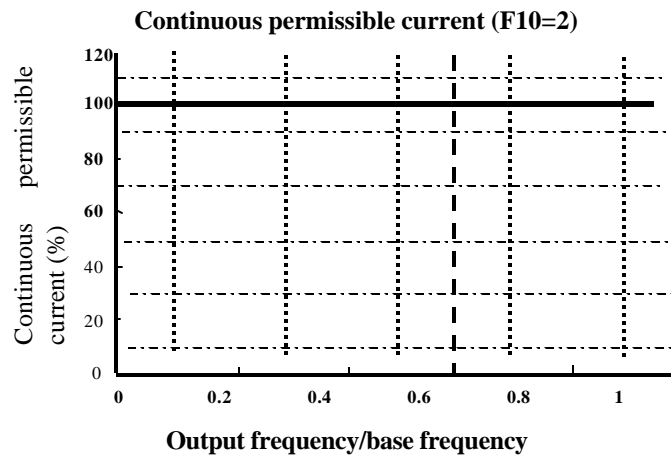
1	0.	0
---	----	---

This function sets the operating time of the electronic thermal O/L relay when the current that is 150% of the operation level flows. 0.5 to 10.0 min. can be set (in 0.1 min. step).

The figure on the right shows the continuous permissible current with F10 (electronic thermal O/L relay [Select]) = 1.



The figure at right shows the continuous permissible current with F10 (electronic thermal O/L relay [Select]) = 2. 100% of the continuous permissible current is the current value set with function F11 (electronic thermal O/L relay [Level]).



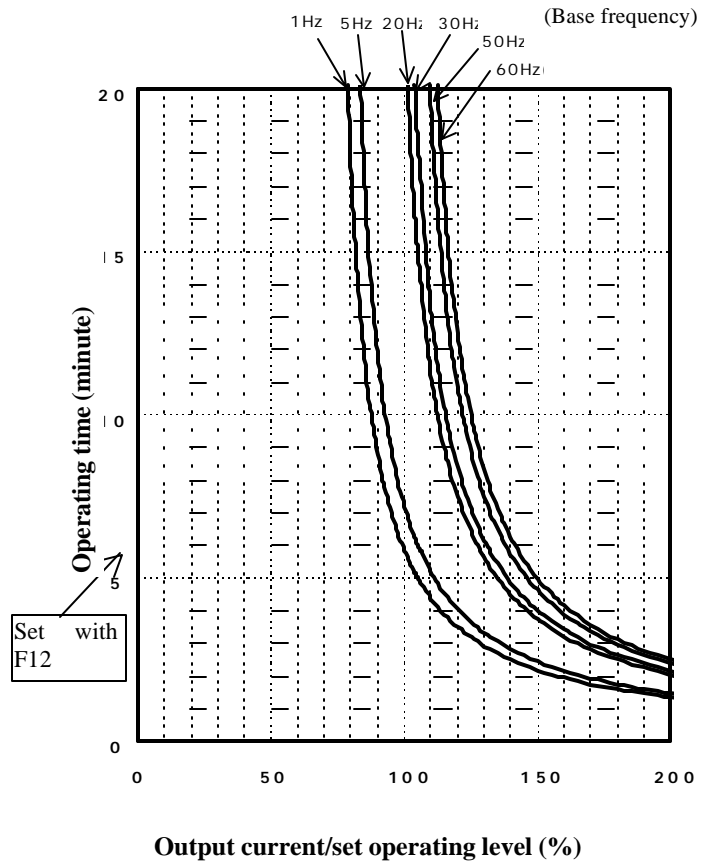
Continued from previous page

The graph at right shows the electronic thermal O/L relay operating characteristics. Output current values for the electronic thermal operating levels (values set with function F11) are plotted horizontally and operating times for output current are plotted vertically.

This graph is for F10 = 1 with the base frequency of 60Hz. The characteristics for output frequencies exceeding the base frequency are the same as the characteristics for the base frequency.

When function F10 is set to 2, the characteristics are always the same as those for the base frequency. The operating time with output current of 150% can be adjusted by using function F12 (electronic thermal O/L relay (thermal time constant)).

### Operating time characteristics



F14

F14 Restart mode after momentary power failure

Factory setting	Change during Operation
0	N

This function determines whether operation is restarted upon recovery from momentary power failure:

		0
--	--	---

 Inactive

Failure while drive is stopped:

The stop status is continued after recovery from the failure.

Failure during operation:

LU indication is held immediately due to undervoltage and the drive trips with alarm output.

		1
--	--	---

 Inactive

Failure while drive is stopped:

The stop status is continued after recovery from the failure.

Failure during operation:

LU indication is held upon recovery from the failure and the drive trips with alarm output.

		2
--	--	---

 Active

The drive restarts with the frequency at the momentary power failure when 0.5s elapses after recovery from the fail

		3
--	--	---

 Active

The drive restarts with the starting frequency when 0.5s elapses after recovery from the failure.

		2
--	--	---

, 

		3
--	--	---

=valid upon recovery from the failure with LU being on. The table below lists approximate LU indication times for a momentary power failure during operation.

Drive HP	1/8	1/4	1/2	1	2	3	5	[Second]
3 phase input	0.4	0.6	1.2	1.9	1.7	2.4	4.1	
Single Phase Input	0.6	1.2	2.6	4.8	3.0	5.0	-	

F15 Frequency limiter (High)

Factory setting	Change during Operation
70Hz	Y

F16 Frequency limiter (Low)

Factory setting	Change during Operation
0Hz	Y

This function sets the upper and lower limits of output frequencies.

		0
--	--	---

 } 0 to 120Hz can be set with a resolution of 1Hz.  
to  

1	2	0
---	---	---

If the upper limit and lower limit settings are reversed, the upper limit is valid and the lower limit is ignored.

Hence, the operation is always performed with the upper limit regardless of the frequency setting.



Change during operation: N = impossible, Y\* = possible (enabled by using 

FUNC
DATA

), Y= possible (enabled by using 

▲
▼

)

F17

Gain   
(for frequency setting signal)

Factory setting	Change during operation
0	N

This function outputs the frequency obtained by multiplying the reference frequency by a ratio. This function selects an analog input signal level with a value from 

		1
--	--	---

 to 

		4
--	--	---

 that is set by function 

F	0	1
---	---	---

.  

		0
--	--	---

 The maximum frequency is output at +10Vdc (20mA dc).  

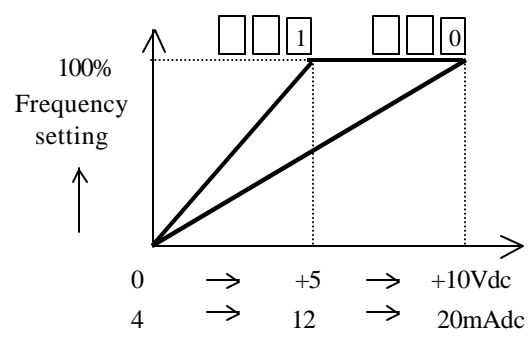
		1
--	--	---

 The maximum frequency is output at +5Vdc (12mA dc).

When this function is used with function 

F	1	8
---	---	---

 (bias frequency), the gain set with this function is valid and the gained frequency is biased.



F18

Bias frequency

Factory setting	Change during operation
0	Y

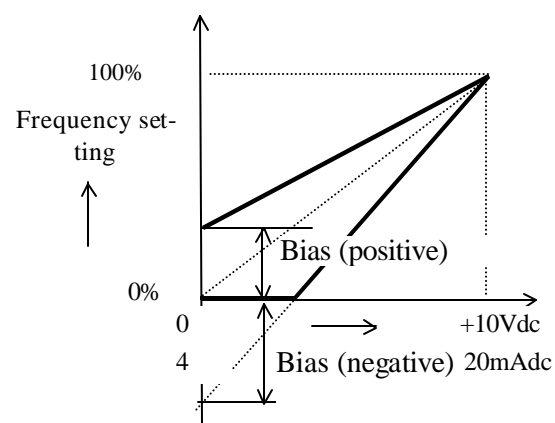
This function outputs a frequency biased for the analog frequency setting.  

-1	2	0
----	---	---

  
to  

1	2	0
---	---	---

 } -120 to 120Hz can be set with a resolution of 1Hz.



Change during operation: N = impossible, Y\* = possible (enabled by using 

FUNC
DATA

 ), Y= possible (enabled by using 

△
▽

 )

**F20** DC injection brake  
(starting frequency)

Factory setting	Change during operation
3.0Hz	N

This function sets 3.0Hz (fixed) as the starting frequency of DC injection brake.

**F21** DC injection brake (Braking level)

Factory setting	Change during operation
0%	Y

This function sets a DC brake current level.

Levels can be set in 1% unit by assuming the level of the drive rated current to be 100%.

**F22** DC injection brake(Braking time)

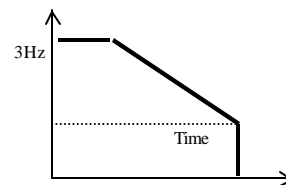
Factory setting	Change during operation
0.0s	Y

This function sets the DC injection braking time.

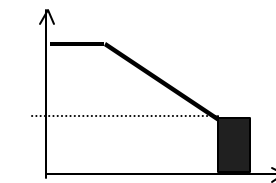
0.0 : No DC injection braking

0.1 to 30.0 : DC injection braking time 0.1 to 30s (in 0.1s step)

Output Freq.



Output voltage



DC injection brake

**⚠ CAUTION**

Do not use the drive brake function for mechanical holding,  
**otherwise injuries could occur.**

Change during operation: N = impossible, Y\* = possible (enabled by using 

FUNC
DATA

), Y= possible (enabled by using 

△
▽

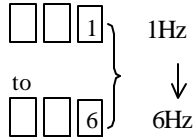
)

F23 Starting frequency

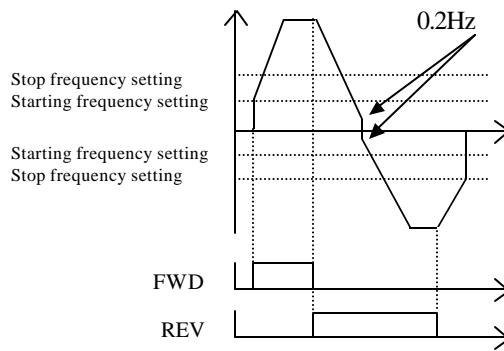
	Factory setting	Change during Operation
F23	1Hz	N
F25	1Hz	N

F25 Stop frequency

These functions set a starting or stop frequency in a range from 1 to 6Hz in 1Hz step.

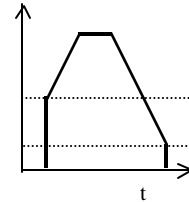


Output frequency in forward/  
reverse operation



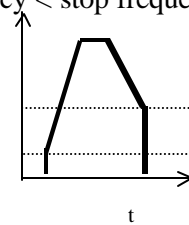
Starting frequency stop frequency

Starting frequency setting  
Stop frequency setting



Starting frequency < stop frequency

Stop frequency setting  
Starting frequency setting



If the set frequency is lower than the stop frequency, the drive output is 0Hz.

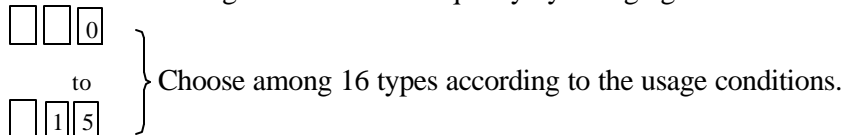
F24 Data cannot be changed.

Factory setting	Change during operation
0.0	-

F26 Motor sound  
(carrier freq.)

Factory setting	Change during operation
2kHz	Y

This function changes the motor tone quality by changing the carrier frequency.



Data code 0: 0.75kHz (Low carrier)


1: 1kHz

2: 2kHz

15: 10kHz (High carrier, low noise)

Note: When the drive is operating at 9kHz or higher carrier frequency, the carrier frequency for may be reduced to 8kHz automatically to protect the drive.

F27

Motor sound   
(sound tone)

Factory setting	Change during operation
0	Y

This function adjusts the motor operation sound when a value of 7 or less is set with function F26.

		0
--	--	---


 Level 0

to  

		3
--	--	---

 Level 3

F30

FM terminal (voltage adjust) 

Factory setting	Change during operation
100%	Y

This function regulates the frequency meter voltage level output to the FM terminal in the range from 0 to 200% (in 1% step).

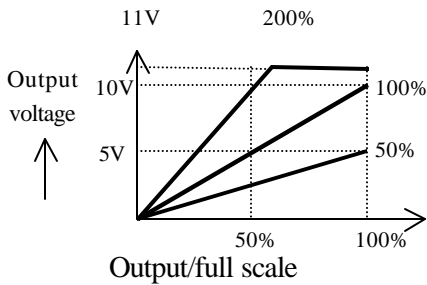
		0
--	--	---

 (Full scale about 0Vdc)

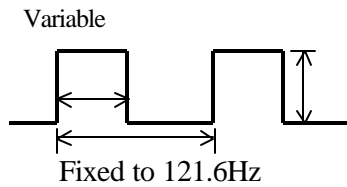
to  

2	0	0
---	---	---

 (Full scale about 11Vdc)



Note : Output to the FM terminal is pulse output with constant frequency and variable duty.



F31

FM terminal (Function) 

Factory setting	Change during operation
0	Y*

This function selects the contents of output to the FM terminal.

		0
--	--	---

 Output frequency (maximum output frequency = 100%)

		1
--	--	---

 Output current (drive rated current x 2 = 100%)

		2
--	--	---

 PID feedback value (full scale = 100%)

		3
--	--	---

 DC link circuit voltage (500Vdc = 100%)

Change during operation: N = impossible, Y\* = possible (enabled by using 

FUNC
DATA

 ), Y= possible (enabled by using 

△
▽

 )

F36

30Ry operation mode

Factory setting	Change during operation
0	N

This function sets the operation mode of alarm output for any fault (30Ry).

F36	Normal operation	Tripped
0 (Excited when tripped)		
1 (Normally excited)		

\* The status without drive power supply is the same as the status when drive is tripped.

Change during operation: N = impossible, Y\* = possible (enabled by using  FUNC  DATA ), Y= possible (enabled by using    )

E01 X1 terminal function

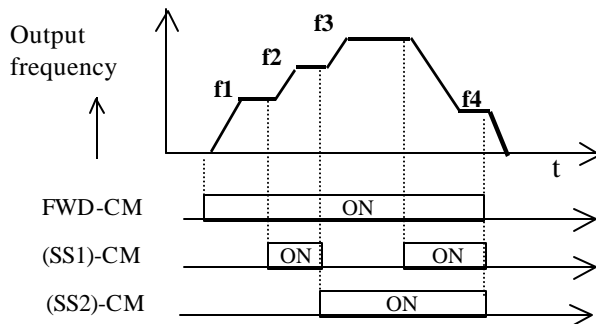
E02 X2 terminal function

E03 X3 terminal function

	Factory setting	Change during operation
E01	0	N
E02	2	N
E03	3	N

0 Multistep frequency selection 1 (SS1)

1 Multistep frequency selection 2 (SS2)



f1 : Frequency selected with F01  
(keypad panel/analog/freq. setting POT )

f2 : Frequency selected with C05

f3 : Frequency selected with C06

f4 : Frequency selected with C07

OFF input is assumed if SS1 or SS2 is not selected.

2 Coast-to-stop command

Drive output is cut when the BX terminal is connected to the CM terminal.

OFF input is assumed when BX is not selected.

3 Alarm reset (RST)

The alarm output is released between the RST and CM terminals when power is turned on.

The trip status is released between the RST and CM terminals when power is turned off.

(Refer to 6-2 Alarm Reset on page 60)

4 External alarm (THR)

Drive trips with OH2 when the THR terminal is disconnected from the CM terminal.

ON input is assumed when THR is not selected.

5 Write enable command for keypad(WE-KP)

Function change from the keypad panel is disabled when the WE-KP terminal is disconnected from the CM terminal.

Function change from the keypad panel is enabled when the WE-KP terminal is connected to the CM terminal.

ON input is assumed when WE-KP is not selected.

6 PID control cancel (Hz/PID)

PID control operates when the Hz/PID terminal is disconnected from the CM terminal and does not operate when they are connected.

OFF is assumed when the Hz/PID is not selected.

Hz/PID is valid only when function    H    2    0 is set to    1 or    2 .

(PID control operation).

Continued from previous page

7

 Link operation selection (LE)

Operation setting can be done by commands from RS485 when the LE terminal is connected to the CM terminal.

A command from RS485 is ignored when the LE terminal is disconnected from the CM terminal.

ON input is assumed when LE is not selected.

LE is valid only when function 

0
0
0

 is set to 

1

 (option operation).

Note: Set function 

E
0
3

 to a value from 

0

 to 

3

 when using the X3 terminal as a PLC terminal (SW7 is set to PLC).

Change during operation: N = impossible, Y\* = possible (enabled by using 

FUNC
DATA

), Y = possible (enabled by using 

△
▽

)

**C01** **C02** **C03** Jump frequency 1, 2, 3

	Factory setting	Change during operation
C01	0.0Hz	Y
C02	0.0Hz	Y
C03	0.0Hz	Y

These functions jump frequencies to prevent overlap between the load mechanical resonance point and drive output frequency.

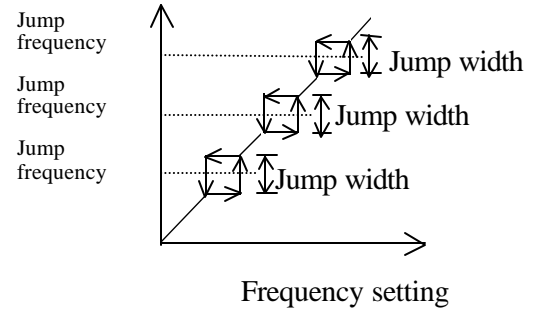
Up to three jump points can be set.

These function do not operate when 0Hz is set.

No frequency is jumped during acceleration and deceleration.

If three continuous frequencies are set, the total of the three jump widths is set as the jump width.

Output Frequency



**C04** Jump frequency (Hysteresis)

Factory setting	Change during operation
3Hz	Y

This function sets a jump width in a range from 0 to 30Hz in 1Hz step.

**C05** Multistep frequency setting 1

	Factory setting	Change during operation
C05	0.0Hz	Y
C06	0.0Hz	Y
C07	0.0Hz	Y

**C06** Multistep frequency setting 2

**C07** Multistep frequency setting 3

These functions set a multistep frequency setting from 0 to 120Hz in 0.1Hz step (for 99.9 Hz or less) or 1Hz step (for 100Hz or more) by switching the external contact signal.

The ON and OFF of terminal function SS1/SS2 (see explanation of E01, E02, and E03) switches between the frequencies set by these functions C05, C06, and C07.

**P00** Motor characteristics

Factory setting	Change during operation
2	Y

This function removes abnormalities in the output current such as current vibration.

0 Current vibration is not suppressed.

to

1 0 Current vibration is minimized.



Change during operation: N = impossible, Y\* = possible (enabled by using 

FUNC
DATA

), Y= possible (enabled by using 

△
▽

)

**H01** Operation time

Factory setting	Change during operation
0	Monitoring only.

This function displays the integration time of power supply applied to the drive.

0 to 655 are displayed to indicate 0 to 65500 hours.

If the integration time exceeds 65500 hours, 65500 is displayed continuously. While the total of power supply times is less than one hour, the times are not integrated.

**H02** Trip history

Factory setting	Change during operation
---	Monitoring only.

This function memorizes the history of the last four protection operations.

Each data item can be called using the 

▽
---

 key.

The calling procedure is shown below:

No.	Procedure		Display example	Remarks						
1	Call <table border="1" style="display: inline-table; vertical-align: middle;"><tr><td>H</td><td>0</td><td>2</td></tr></table>		H	0	2	<table border="1" style="display: inline-table; vertical-align: middle;"><tr><td>H</td><td>0</td><td>2</td></tr></table>	H	0	2	
H	0	2								
H	0	2								
2	Press the <table border="1" style="display: inline-table; vertical-align: middle;"><tr><td>FUNC</td></tr><tr><td>DATA</td></tr></table> key	FUNC	DATA	Press the <table border="1" style="display: inline-table; vertical-align: middle;"><tr><td>△</td></tr></table> key	△	<table border="1" style="display: inline-table; vertical-align: middle;"><tr><td>O</td><td>U</td><td>2</td></tr></table>	O	U	2	The contents (history) of the latest alarm are displayed.
FUNC										
DATA										
△										
O	U	2								
3	Press the <table border="1" style="display: inline-table; vertical-align: middle;"><tr><td>▽</td></tr></table> key	▽	Press the <table border="1" style="display: inline-table; vertical-align: middle;"><tr><td>△</td></tr></table> key	△	<table border="1" style="display: inline-table; vertical-align: middle;"><tr><td>O</td><td>H</td><td>2</td></tr></table>	O	H	2	The contents of the second latest alarm are displayed.	
▽										
△										
O	H	2								
4	Press the <table border="1" style="display: inline-table; vertical-align: middle;"><tr><td>▽</td></tr></table> key	▽	Press the <table border="1" style="display: inline-table; vertical-align: middle;"><tr><td>△</td></tr></table> key	△	<table border="1" style="display: inline-table; vertical-align: middle;"><tr><td>O</td><td>C</td><td>I</td></tr></table>	O	C	I	The contents of the third latest alarm are displayed.	
▽										
△										
O	C	I								
5	Press the <table border="1" style="display: inline-table; vertical-align: middle;"><tr><td>▽</td></tr></table> key	▽	Press the <table border="1" style="display: inline-table; vertical-align: middle;"><tr><td>△</td></tr></table> key	△	<table border="1" style="display: inline-table; vertical-align: middle;"><tr><td>-</td><td>-</td><td>-</td></tr></table>	-	-	-	The contents of the fourth latest alarm are displayed. (This example is for no history.)	
▽										
△										
-	-	-								
6	Press the <table border="1" style="display: inline-table; vertical-align: middle;"><tr><td>▽</td></tr></table> key	▽		<table border="1" style="display: inline-table; vertical-align: middle;"><tr><td>E</td><td>n</td><td>d</td></tr></table>	E	n	d			
▽										
E	n	d								

The contents of a new alarm is stored in the data area for the history of the latest alarm. At this time, the history of the latest alarm is stored in the data area for the second latest alarm. The histories of the second and third latest alarms are moved in this way and the history of the fourth latest alarm is deleted. Stored trip histories are not deleted although data initialization is executed with H03.

Change during operation: N = impossible, Y\* = possible (enabled by using 

FUNC DATA
--------------

), Y= possible (enabled by using 

^
---

v
---

)

**H03** Data initialization

Factory setting	Change during operation
0	N

This function initializes data items set with all functions to values set in the factory.

		0
--	--	---

 Manually set value

		1
--	--	---

 Initialized (factory set value )

The display is changed from 

		0
--	--	---

 to 

		1
--	--	---

 when the 

STOP
------

 and 

^
---

 keys are pressed simultaneously.

When the 

FUNC DATA
--------------

 key is pressed under this condition, initial data is written and a frequency set by the built-in POT (VR) is displayed automatically.

**H04** Auto Reset

Factory setting	Change during operation
0	Y*

This function selects a retry operation if the drive is tripped.

		0
--	--	---

 : Inactive

to

		1
--	--	---

 : The auto reset count is fixed to 5 and auto reset starts when 0.5s elapses after tripping .

Auto reset is attempted only for an overcurrent/overvoltage trip that occurs during operation.

**H06** Fan stop operation

Factory setting	Change during operation
0	Y*

		0
--	--	---

 : ON-OFF No control (always on)

		1
--	--	---

 : ON-OFF Control

(The fan is turned off when the drive temperature becomes low after operation is stopped.)

**H20** PID control (Mode select)

Factory setting	Change during operation
0	N

		0
--	--	---

 : Inactive

		1
--	--	---

 : Active (Normal)

		2
--	--	---

 : Active (Inverse)

} Select a PID control operation.

The feedback signal value (%) is displayed by assuming the full scale to be 100% when a PID control operation is selected.

Change during operation: N = impossible, Y\* = possible (enabled by using 

FUNC
DATA

), Y= possible (enabled by using 

△
▽

)

**H21** PID control —————

Factory setting	Change during operation
1	N

(Feedback signal)

This function selects a PID control feedback signal.

- |  |  |   |
|--|--|---|
|  |  | 0 |
|--|--|---|

 Terminal 12(0 to +10Vdc)
- |  |  |   |
|--|--|---|
|  |  | 1 |
|--|--|---|

 Terminal C1(4 to 20mA dc)
- |  |  |   |
|--|--|---|
|  |  | 2 |
|--|--|---|

 Terminal 12(+1 to +5Vdc)

**H22** PID control (P-gain) —

Factory setting	Change during operation
0.01	Y

This function sets a P-gain.

0	0	1
---	---	---

 to 

1	0	0
---	---	---

 P-gain from 0.01 to 10.0 times (1 to 1000%) (in increment of 0.01 step)

**H23** PID control (I-gain) —

Factory setting	Change during operation
0.0s	Y

This function sets an integral time.

- |  |   |   |
|--|---|---|
|  | 0 | 0 |
|--|---|---|

 : No integration
  - |  |   |   |
|--|---|---|
|  | 0 | 1 |
|--|---|---|

 to 

9	9	9
---	---	---

 : Integral time 0.1 to 999s
- (in 0.1s step for 99.9s or less, 1s step for 100s or more)

**H24** PID control (D-gain) —

Factory setting	Change during operation
0.00s	Y

This function sets a derivative time.

- |   |   |   |
|---|---|---|
| 0 | 0 | 0 |
|---|---|---|

 : No derivative
- |   |   |   |
|---|---|---|
| 0 | 0 | 1 |
|---|---|---|

 to 

1	0	0
---	---	---

 : Derivative time 0.01 to 10.0s (in 0.01s step)

**H25** PID control —————

Factory setting	Change during operation
0.5s	Y

(Feedback filter)

This function sets a filter time constant of PID feedback.

	0	0
--	---	---

 to 

6	0	0
---	---	---

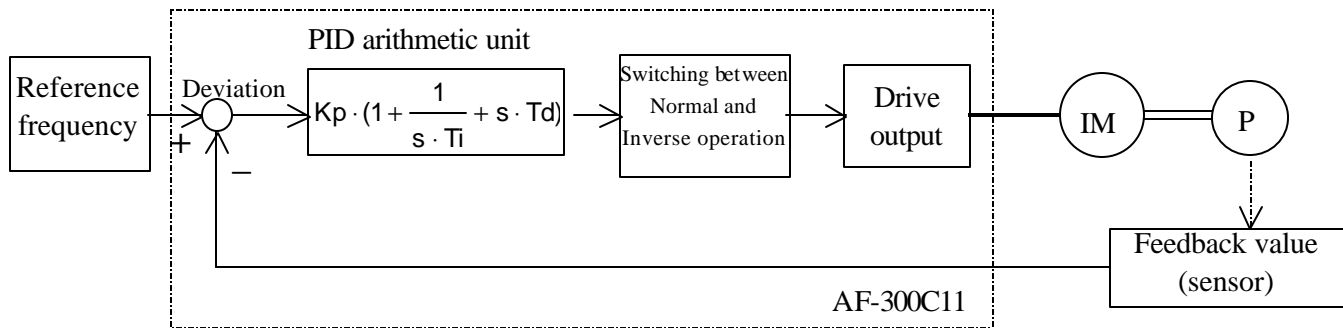
 : Time constants 0.0 to 60.0s (in 0.1s step)

Change during operation: N = impossible, Y\* = possible (enabled by using  $\frac{\text{FUNC}}{\text{DATA}}$ ), Y = possible (enabled by using  $\wedge \vee$ )

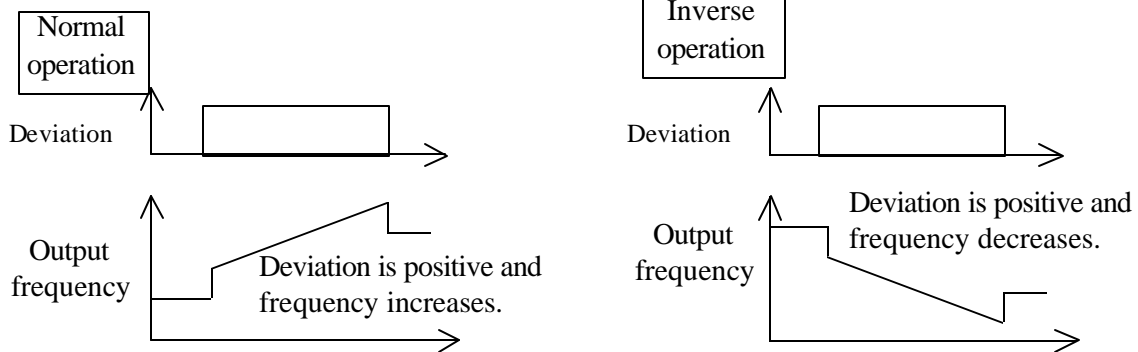
**PID control**

In PID control, an output frequency is adjusted to a feedback value.

Use  $\text{F } \boxed{0} \boxed{1}$  to set a frequency and  $\text{H } \boxed{2} \boxed{1}$  to make the feedback value and the reference value equal.



Kp : P-gain    Td : Derivative time    Ti : Integral time



**o00** Option selection (RS485 RTU communication)

Factory setting	Change during operation
0	Y*

- $\boxed{\phantom{0}} \boxed{\phantom{0}} \boxed{0}$  : Option inactive
- $\boxed{\phantom{0}} \boxed{\phantom{0}} \boxed{1}$  : Option active

Always set  $\boxed{\phantom{0}} \boxed{\phantom{0}} \boxed{0}$  when the optional RS485 RTU serial communication unit is not used.

If  $\boxed{\phantom{0}} \boxed{\phantom{0}} \boxed{1}$  is set, Er 8 occurs.

**For explanations of “o01” to “o11”, refer to the instruction manual that comes with the optional RS485 serial communication unit.**

## 6 Protective Function

### 6-1 List of protective functions

When the protective function is activated, drive output is instantly cut off (while the motor coasts until it is stopped), and an alarm is issued, and the details of the alarm are displayed on the keypad panel.

**Table 6-1-1 List of Protective Functions**

Alarm Name	Keypad panel display	Contents of operation	
Overcurrent	OC1	During acceleration	If the drive output current momentarily exceeds the overcurrent detection level because of an overcurrent in the motor or the short-circuit in the output circuit, the output is shut down, an alarm is issued, and the drive is tripped.
	OC2	During deceleration	
	OC3	While running at constant speed	
Overvoltage	OU1	During acceleration	If the DC voltage of the main circuit exceeds the overvoltage detection level because of an increase in the regenerating current from the motor, etc., output is shut down, an alarm is issued, and the drive is tripped. However, protection against inadvertent overvoltage loading (e.g., high-voltage line) might not be provided.
	OU2	During deceleration	
	OU3	While running at constant speed	
Undervoltage	LU	<p>If the DC voltage of the main circuit falls below the undervoltage detection level because of a lowered power supply, output is shut down to protect the drive. If the restart function after momentary power failure is not activated, an alarm is issued and the drive is tripped.</p> <p>If the restart function is activated, the drive restarts automatically with no alarm.</p> <p>For further details of the protective function, refer to the descriptions of Function F14.</p>	
Overheating of heat sink	OH1	If the temperature of the heat sink used for cooling the rectifier diodes and IGBTs rises because of cooling fan failure, etc., protective function is activated to stop operation, an alarm is issued, and the drive is tripped.	
External Alarm	OH2	If the control circuit terminal THR (functional change of X1 to X3 terminals) is set to OFF, an alarm is issued and the drive is tripped.	
Motor overload	OL	If the motor current exceeds the operating level set by the electronic thermal O/L relay, output is shut down to protect the motor, an alarm is issued, and the drive is tripped.	
Drive overload	OLU	If the output current exceeds the drive rated overload current, output is shut down, an alarm is issued, and the drive is tripped.	

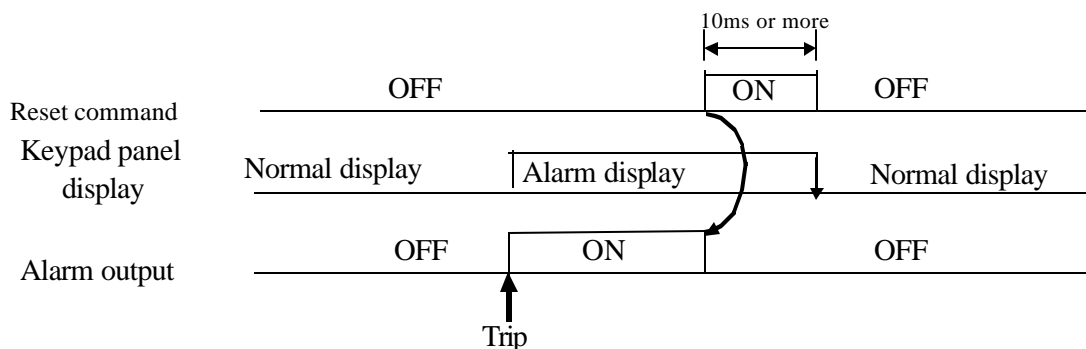
Alarm Name	Keypad panel display	Contents of operation
Memory Error	Er1	If memory error occurs, such as a missing or invalid data, output is shut down, an alarm is issued, and the drive is tripped.
CPU Error	Er3	If CPU error occurs because of noise, etc., output is shut down, an alarm is issued, and the drive is tripped.
Operating Error	Er6	Detects drive operating procedure error during drive startup. FWD or REV connected to terminal CM when Main power is applied to drive (F02 setting 3 or 4). Stop key on keypad is pressed in terminal operation (F02 setting 1 or 3).
RS485 Communication Error	Er8	If an error occurs in serial communication via the RS485, output is shut down, an alarm is issued, and the drive is tripped. For further details, refer to the instruction manual for RS485 communication cards.
Input phase failure (only for 3-phase 200V series)	Lin	If one of the input three phases is lost or the imbalance ratio between phases exceeds 2%, output is shut down, an alarm is issued, and the drive trips.

## 6-2 Alarm Reset

To release the trip status, enter the reset command by pressing the reset key or from terminal (RST) after removing the cause of the trip. Since the reset command is an edge operation, be sure to input a command string such as OFF → ON → OFF as shown in Figure 6-2-1.

When releasing the trip status, set the operation command to OFF. When the operation command is set to ON, check that operation starts after resetting.

If the cause of tripping is Er1, reset the error and initialize data. If the drive is not reset, contact GE Fuji.



**Figure. 6-2-1 How to input the reset command**

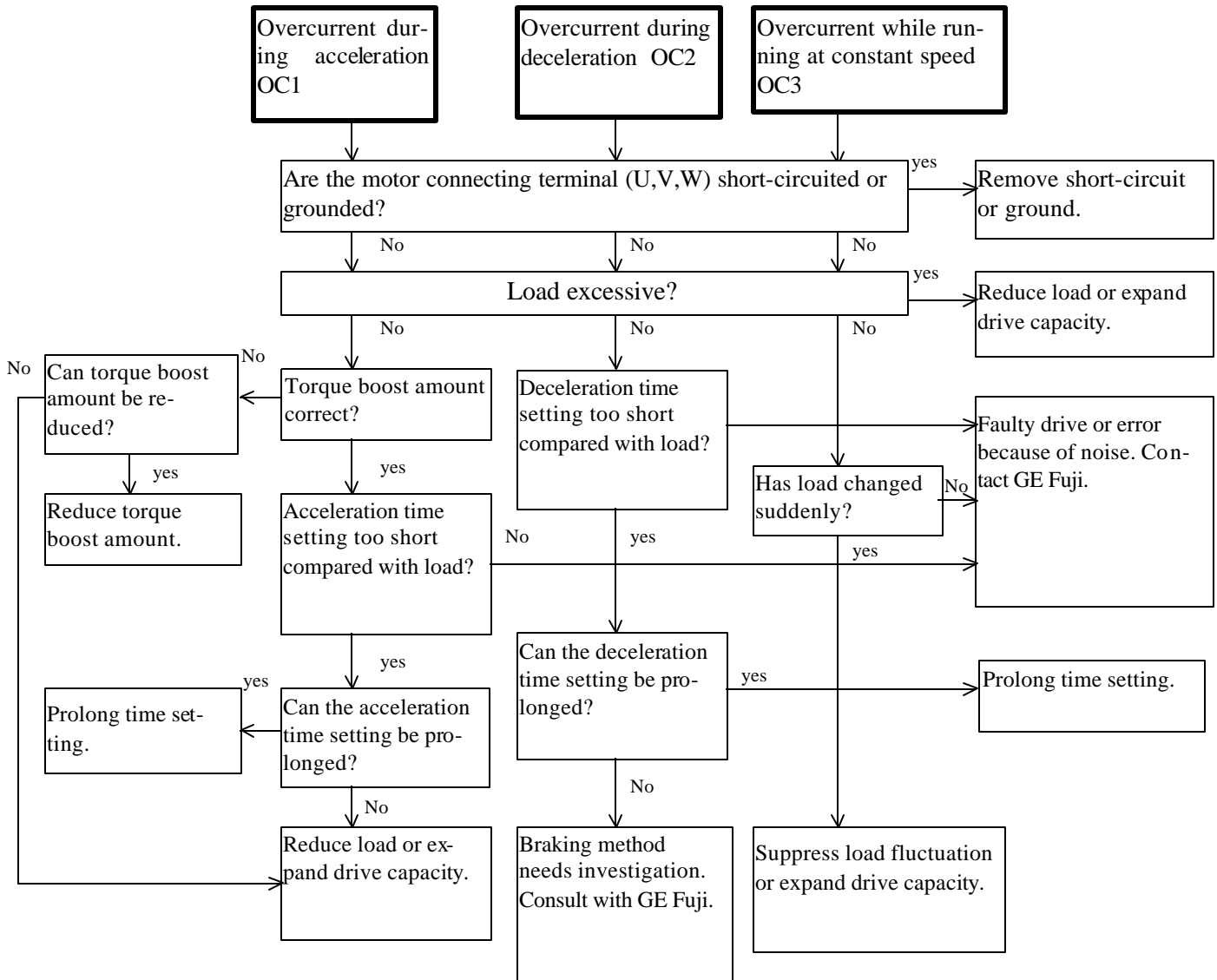
<p><b>⚠ WARNING</b></p>	<p>1. If alarm reset is activated with operation signal ON, the drive suddenly restarts which may be hazardous. Be sure to disable the operating signal when releasing the trip status, <b>otherwise fire could occur.</b></p>
-------------------------	--

# 7 Troubleshooting

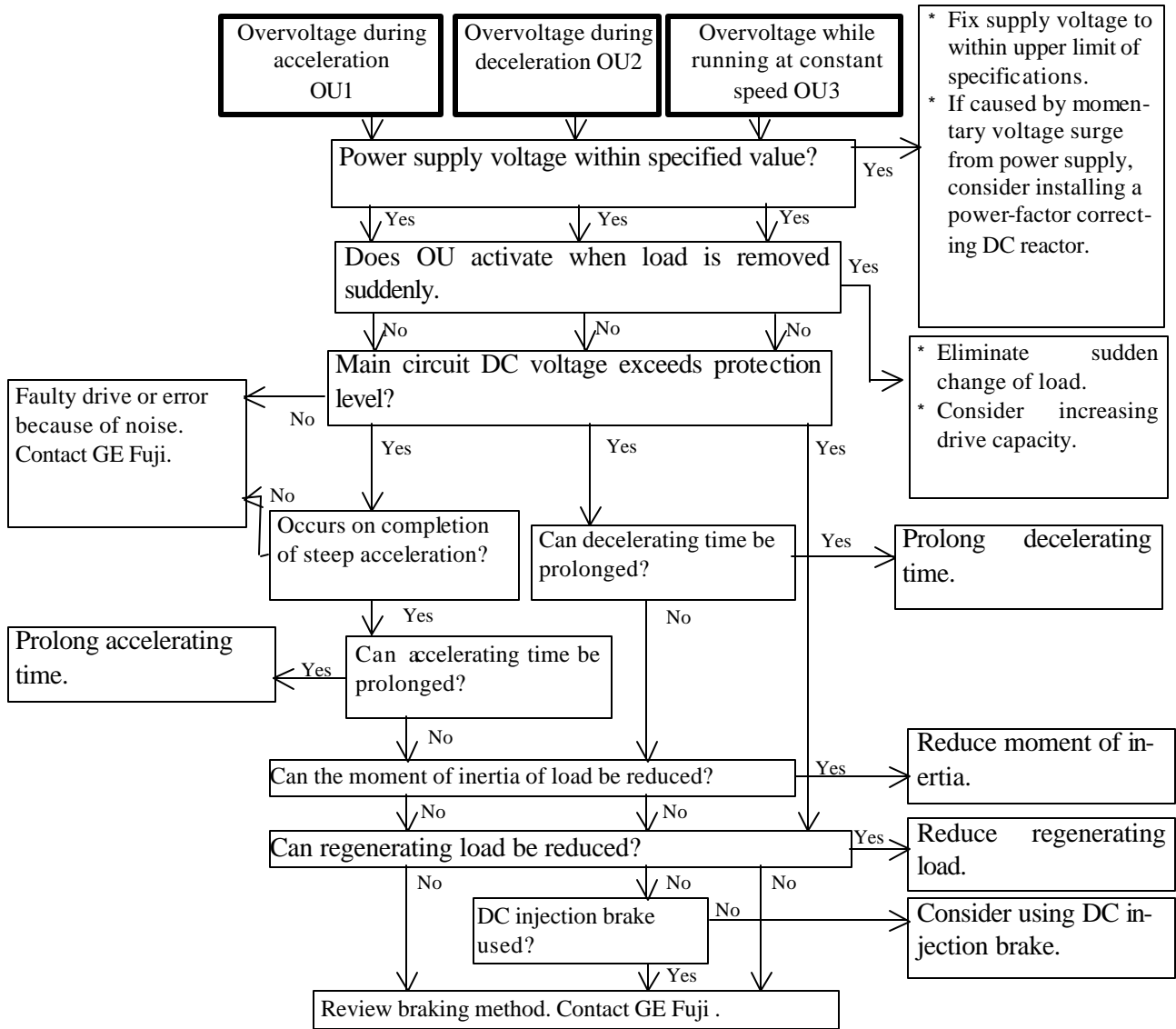
## 7-1 In case of tripping

In the event the drive tripping, diagnose by the help of the alarm display as shown below.

### (1) Overcurrent (OC)



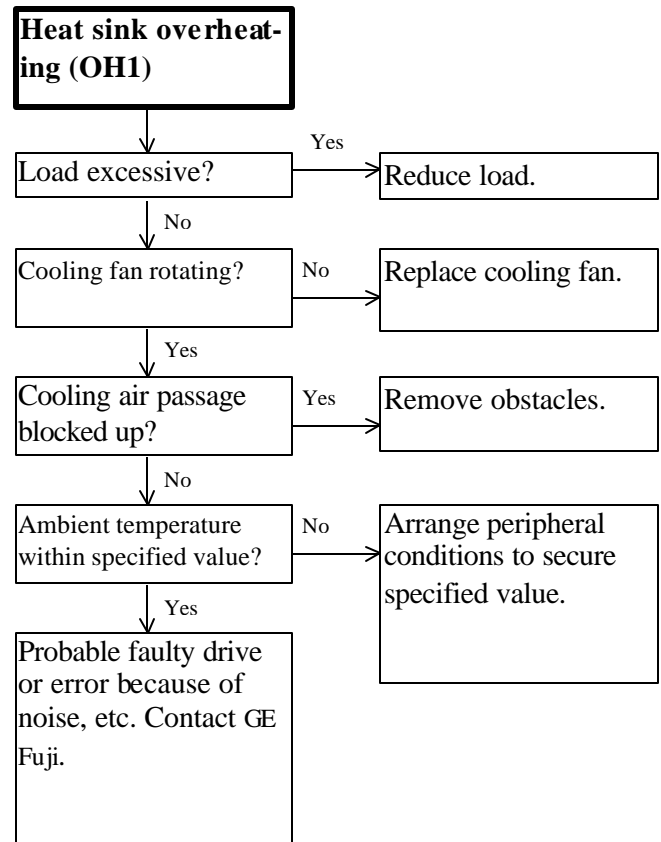
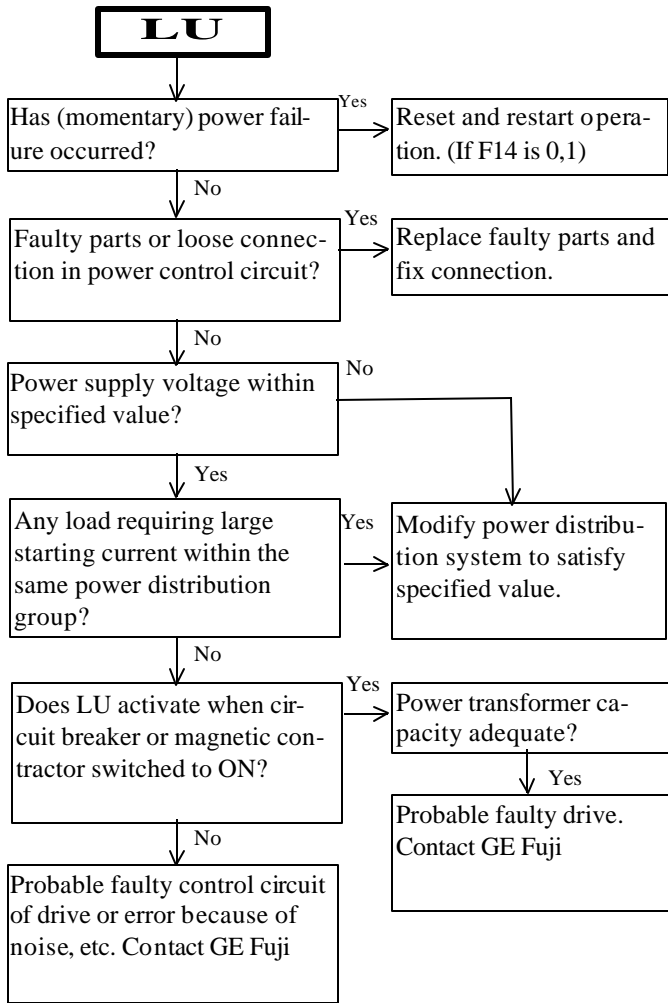
(2) Overvoltage(OU)



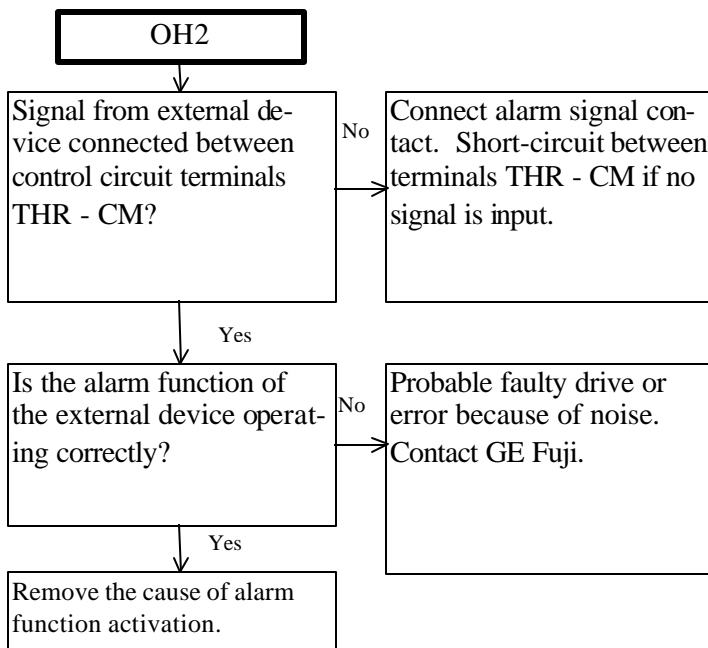


(3) Undervoltage(LU)

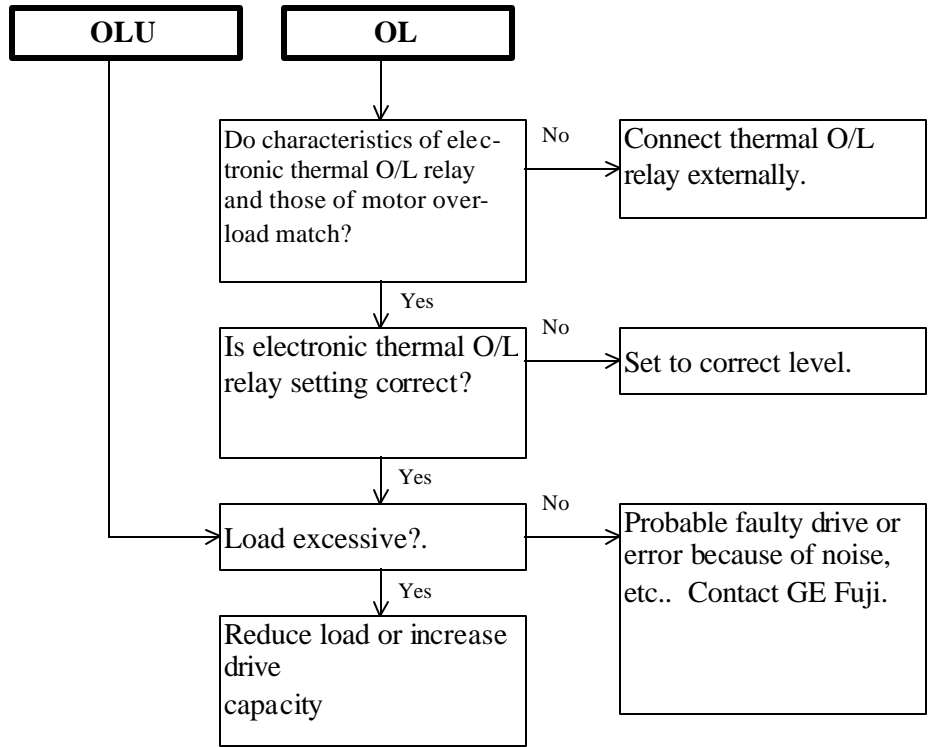
(4)Overheating of heat sink (OH1)



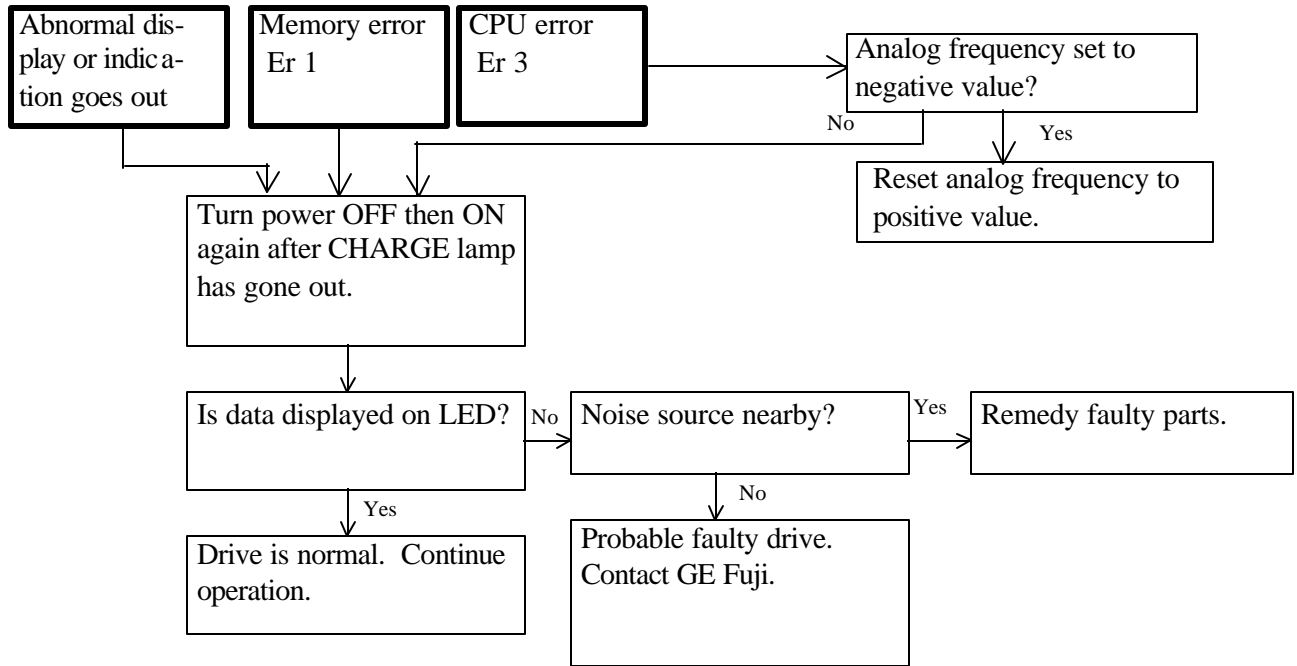
(5) External alarm input (OH2)



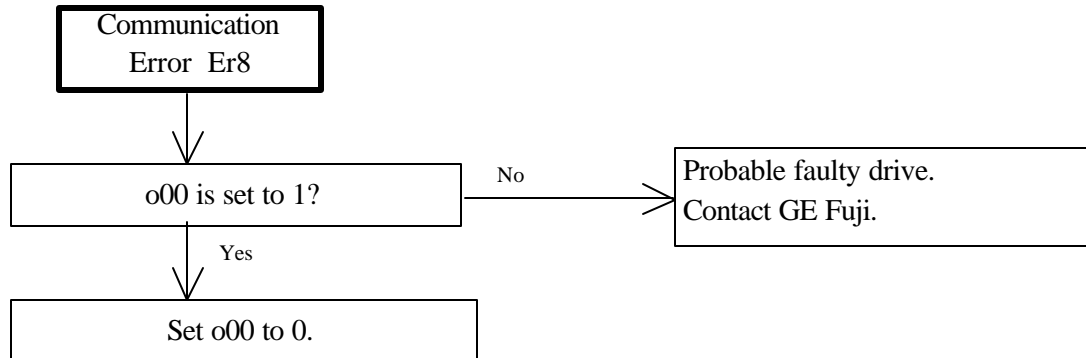
(6) Drive overload (OLU) or motor overload (OL)



(7) Memory error (Er1) CPU error (Er3)

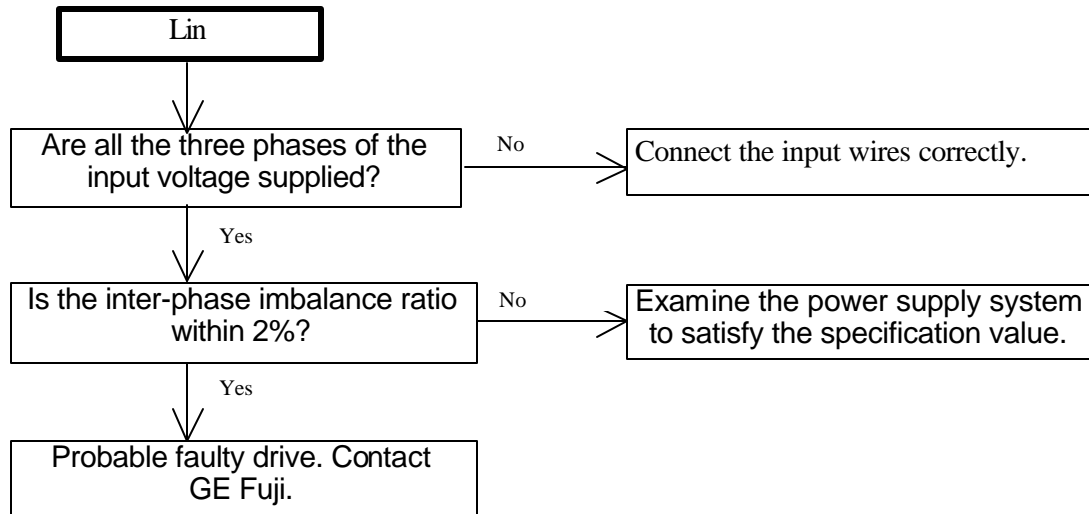


(8) RS485 Communication Error (Er8) [In case RS485 communication is not used]



\* For Er8 measures when using RS485, refer to the instruction manual for optional RS485 communication card.

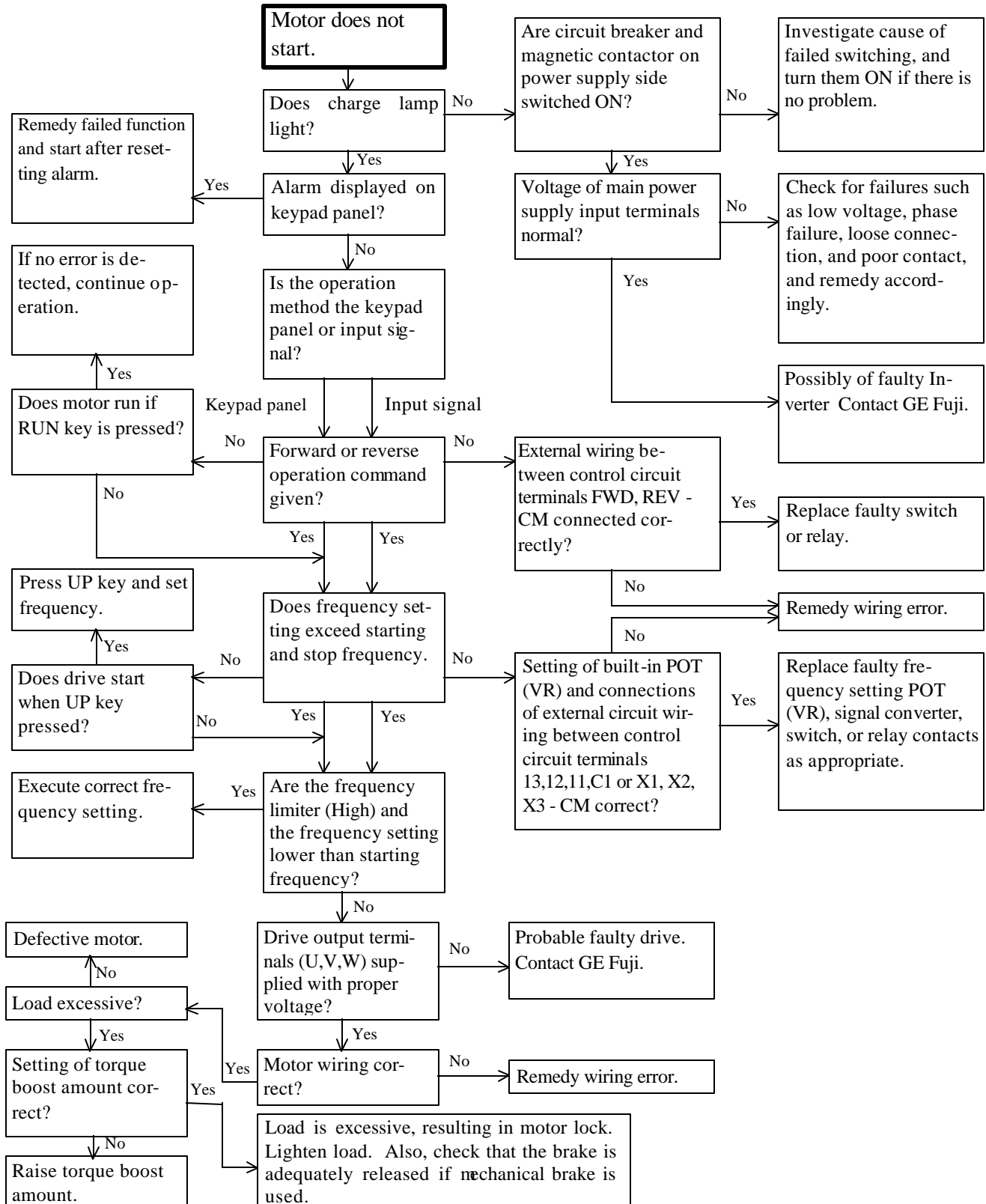
(9) Input phase failure (Lin) and imbalance



## 7-2 Other trouble

### (1) When motor does not rotate.

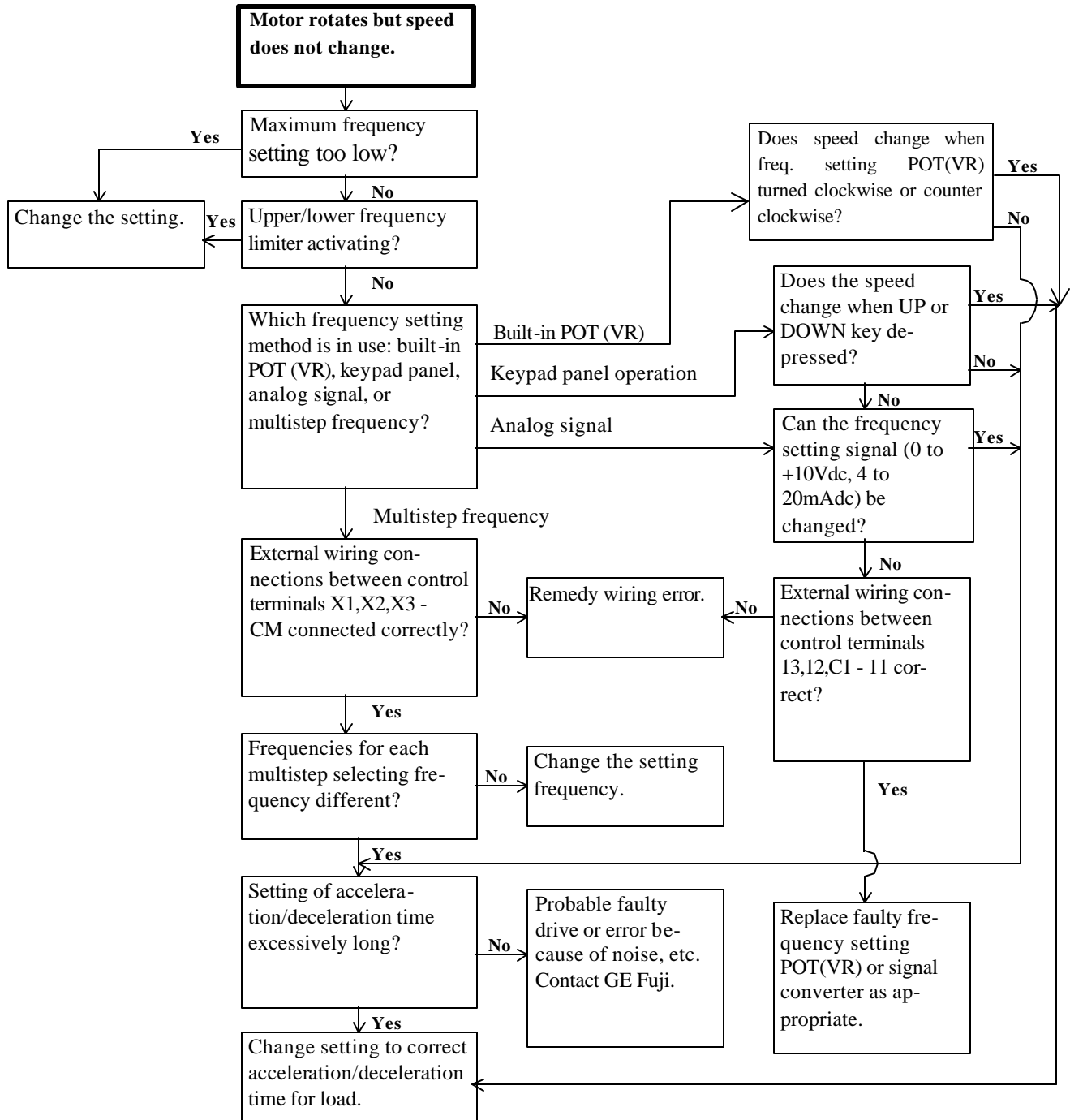
Note : Verify the function settings for the operation commands and frequency setting values on the keypad panel.



The motor does not rotate if the following commands are given.

- 1) An operation command is given while coast-to-stop command is output to the control terminals.
- 2) Both operation command FWD and REV are input.

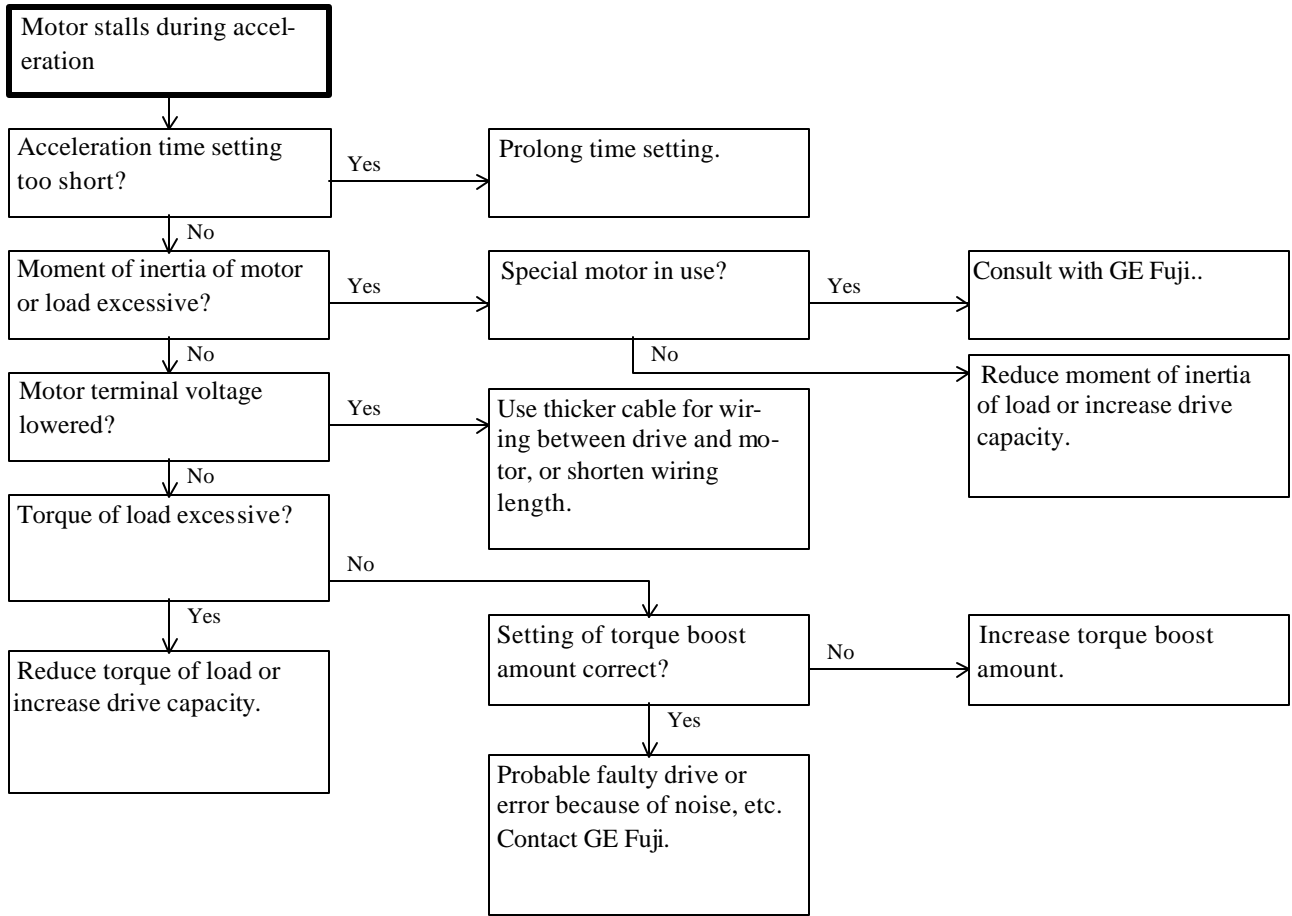
**(2) When motor rotates but the speed does not change.**



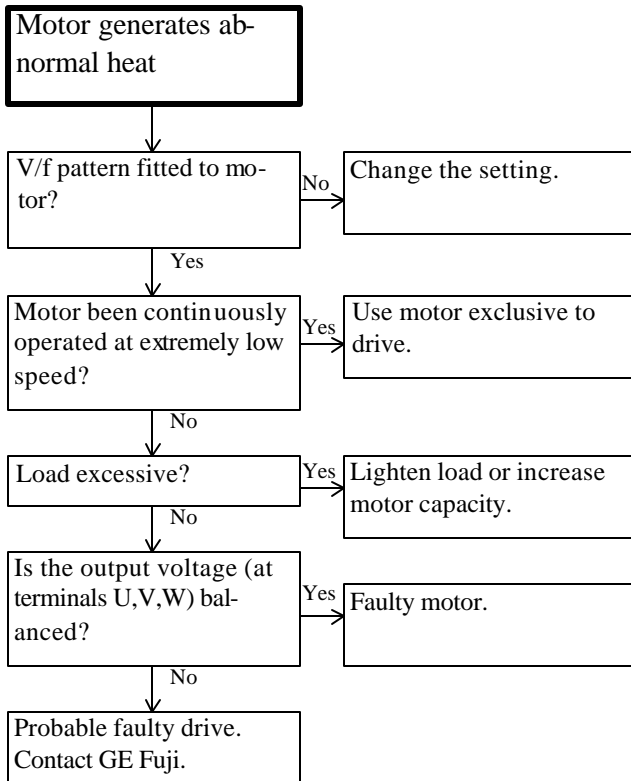
In the following cases, change of motor speed is also restricted.

- 1) Bias frequency (F18) setting value is large.
- 2) Signals are input from both control terminals 12 and C1 and there is no significant change in the added value. (When F01 is 3)
- 3) Load is excessive and stall prevention function is activated.

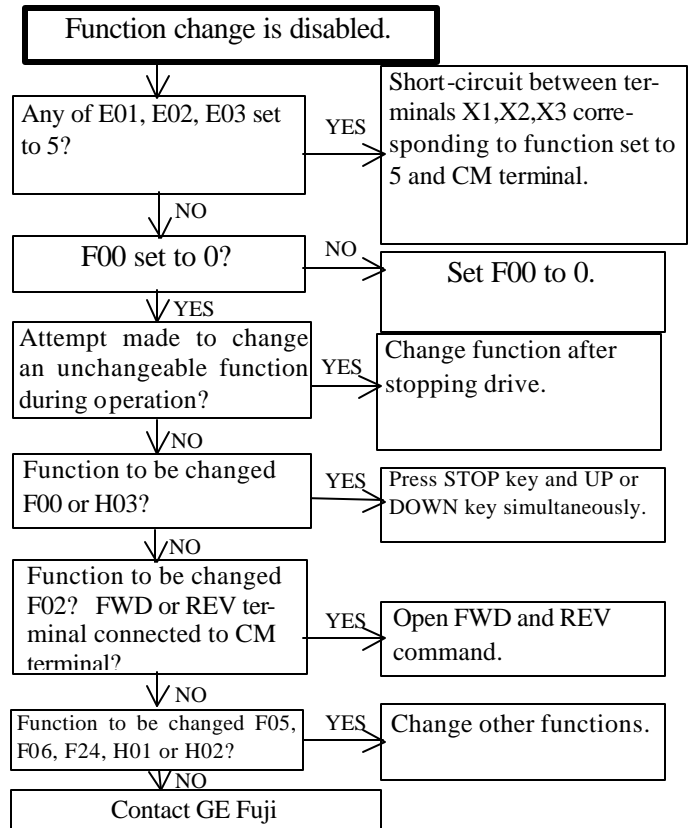
**(3) When motor stalls during acceleration**



**(4) When motor generates abnormal heat**



**(5) When function change disabled**



## 8 Maintenance and Inspection

Execute the daily inspection and periodic inspection for preventing a fault and ensuring long-term reliability.

Note the following regarding the work.

### 8-1 Daily Inspection

During the operation and conduction, the visual inspection for abnormal operation is executed from the outside without removing the covers.

Inspections are usually done to check the following:

- 1) The expected performance (satisfying the standard specification) is obtained.
- 2) The environment satisfies the standard specification.
- 3) The keypad panel display is normal.
- 4) There are no abnormal sound, vibrations or unpleasant odors.
- 5) There are no overheating marks or discoloration.

### 8-2 Periodic Inspection

The periodic inspection must be executed after stopping the operation and cutting off the power source and removing the surface cover.

After power-off, time is needed for the smoothing capacitors in the DC section in the main circuit to discharge. To prevent electric shock, make sure that the voltage falls down to the safety value (25Vdc and below) using a multimeter after the charge lamp (CRG) goes off.

#### WARNING

1. Start inspection five minutes or more after turning off the power supply. (Check that the charge lamp (CRG) goes off, and check the voltage is 25V dc or below between terminals P(+) and N(-)

**There is danger of electric shock.**

2. Only the designated person can perform the maintenance and replace components  
(Take off any metal objects such as a watch or ring.)  
(Use insulated tools.)

3. Never modify the drive.

**There is danger of electric shock or injury.**



**Table 8-2-1 Periodic inspection list**

Check part	Check item	How to inspect	Evaluation criteria	
Environment	<ol style="list-style-type: none"> <li>1) Check the ambient air temperature, humidity, vibration, atmosphere (dust, gas oil mist, waterdrops)</li> <li>2) Are foreign matter or dangerous objects such as tools not left around the equipment?</li> </ol>	<ol style="list-style-type: none"> <li>1) Measure by visual inspection and the meter.</li> <li>2) With visual inspection</li> </ol>	<ol style="list-style-type: none"> <li>1) The specified standard value must be satisfied.</li> <li>2) No foreign matter or dangerous objects left near the drive?</li> </ol>	
Voltage	Are the voltages in the main circuit and the control circuit normal?	Measure with the multimeter.	The specified standard value must be satisfied.	
Keypad panel	<ol style="list-style-type: none"> <li>1) Is the display hard to read?</li> <li>2) Are the characters complete?</li> </ol>	1), 2) Visual inspection	1),2) The display can be read and is not abnormal.	
Structure such as a frame or cover	<ol style="list-style-type: none"> <li>1) Abnormal sound or vibration?</li> <li>2) Loose bolts (part to be tightened) ?</li> <li>3 Deformation or damage?</li> <li>4) Discoloration by overheating?</li> <li>5) Stains and dust?</li> </ol>	<ol style="list-style-type: none"> <li>1) With Visual inspection and hearing</li> <li>2) Tighten more</li> <li>3), 4), 5) With visual inspection</li> </ol>	1), 2), 3), 4), 5) Not abnormal.	
Main circuit	Common	<ol style="list-style-type: none"> <li>1) Loose and missing bolts?</li> <li>2) Deformation, cracks, damage, and discoloration by overheating and deterioration in the equipment and the insulation?</li> <li>3) Stains and dust?</li> </ol>	<ol style="list-style-type: none"> <li>1) Tighten more</li> <li>2), 3) Visual inspection</li> </ol>	<ol style="list-style-type: none"> <li>1), 2), 3): Not abnormal.</li> </ol> <p>Note: A discolored short-circuiting bar does not indicate a problem.</p>
	Conductor and wire	<ol style="list-style-type: none"> <li>1) Discoloration and distortion of a conductor by overheating?</li> <li>2) Cracks, crazing, and discoloration of the wire sheath?</li> </ol>	1), 2) Visual inspection	1), 2) Not abnormal.
	Terminal block	Not damaged?	Visual inspection	Not abnormal.
	Smoothing capacitor	<ol style="list-style-type: none"> <li>1) Electrolyte leakage, discoloration, crazing, and swelling of a case?</li> <li>2) Is a safety valve not out, and are any valves protruding excessively?</li> <li>3) Measure the capacitance if necessary</li> </ol>	<ol style="list-style-type: none"> <li>1), 2) Visual inspection</li> <li>3) Measure using the capacitance measuring instrument (Note)</li> </ol>	<ol style="list-style-type: none"> <li>1), 2) Not abnormal.</li> <li>3) The capacitance is initial value x 0.85 or more.</li> </ol>

Check part		Check item	How to inspect	Evaluation criteria
Main circuit	Resistor	1)Unpleasant smell and crazing of the insulation by overheating 2)No open circuit?	1)Olfactory and visual inspection 2)Visual inspection or use a multimeter by removing a connection on one side.	1)Not abnormal. 2)Less than about $\pm 10\%$ of the indicated resistance value
	Trans-former and reactor	Abnormal buzzing or unpleasant smell?	Aural, olfactory, and visual inspection	Not abnormal.
	Magnetic contactor and relay	1)Rattling when operating? 2)Roughness of contact?	1)Aural 2)Visual inspection	1), 2) Not abnormal.
Control circuit	Control PC board and connector	1)Loose screws or connectors? 2)Unpleasant smell or discoloration? 3)Cracks, damage, deformation, or excessive rust? 4)Electrolyte leakage or a deformed mark on the capacitor?	1)Tighten more. 2)Olfactory and visual inspection 3),4)Visual inspection	1), 2), 3), 4) Not abnormal.
Cooling system	Cooling fan (2 HP or more)	1)Abnormal sound or vibration? 2)Loose of bolts? 3)Discoloration by overheating?	1)Aural and visual inspection. Turn with hand. (Make sure power is off) 2)Tighten more 3)Visual inspection	1)The fan must rotate smoothly. 2), 3)Not abnormal
	Ventilation way	Clogging-up or foreign substance on heat sink or intake/exhaust ports?	Visual inspection	Not abnormal

(Note) Use a capacitance measuring instrument available on the market which is easy to use.

(Remark) If the equipment is stained, wipe it with a cleaning cloth, which is chemically neutral.

Vacuum-clean the dust.

### 8-3 Electrical measurements in the Main Circuit

The indicated values depend on the meter types because of harmonic components included in the voltage and current of the main power supply (input) and the output (motor) side of the drive. Therefore, when measuring with a meter for the commercial power frequency, use the meters shown in Table 8-3-1.

The power-factor cannot be measured using the power-factor meter available on the market which measures the phase difference between voltage and current. When the power-factor must be measured, measure the power, voltage, and current on the input side and output side. Then, calculate the power-factor using the following formulas:

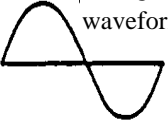
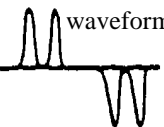
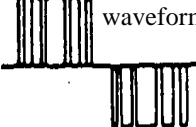
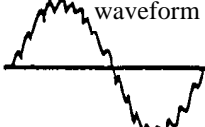





#### Three-phase

$$\text{Power factor} = \frac{\text{Electric power [W]}}{\sqrt{3} \times \text{Voltage [V]} \times \text{Current [A]}} \times 100 [\%]$$

#### Single-phase

$$\text{Power factor} = \frac{\text{Electric power [W]}}{\text{Voltage [V]} \times \text{Current [A]}} \times 100 [\%]$$

**Table 8-3-1 Meter for measuring the main circuit**

Item	Input (power supply) side			Output (motor) side			DC circuit (P(+), N(-)) (FM, 11) Terminal section
	 Voltage waveform	 Current waveform		 Voltage waveform	 Current waveform		
Meter name	Ammeter $A_{R,S,T}$	Voltmeter $V_{R,S,T}$	Wattmeter $W_{R,T}$	Ammeter $A_{U,V,W}$	Voltmeter $V_{U,V,W}$	Wattmeter $W_{U,W}$	DC voltmeter v
Meter type	Moving-iron type	Rectifier or moving-iron type	Power meter	Moving-iron type	Rectifier type (*1)	Power meter	Moving-coil type
Symbol			-			-	

(\*1) When measuring the output voltage by rectifier type meter, an error may occur. Use a digital AC power meter for good accuracy.

[In the case of 3-phase input series]

[In the case of single-phase input series]

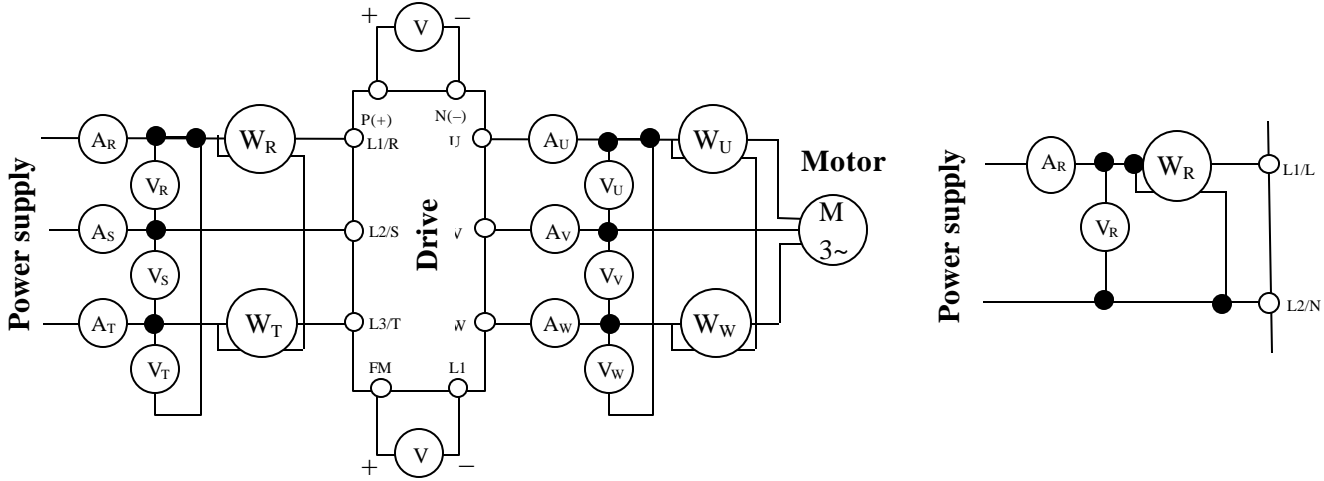


Figure 8-3-1 Diagram for connections of meters

#### 8-4 Insulation Test

As much as possible, do not test the drive with a megger because an insulation test was done at shipping from the factory. If a megger test must be done, test as described below. If the test method is incorrect, there is a possibility of damaging the product. Incorrect use of test specifications for the dielectric strength test may damage products like megger test. If the dielectric strength test must be conducted, contact your local distributor or nearest GE Fuji's sales office.

##### (1) Megger test for the main circuit

- 1) Test with a 500V dc megger.
- 2) If the test voltage is connected to the control circuit, remove all connection wires to the control circuit.
- 3) Connect the main circuit terminals using common wires as shown in Figure 8-4-1
- 4) Execute a megger test only between the common wire connected to the main circuit and the ground (terminal  $\oplus$ G).
- 5) If the megger indicates  $5M\Omega$  or more, it is normal.  
(This is the value measured with a drive only.)

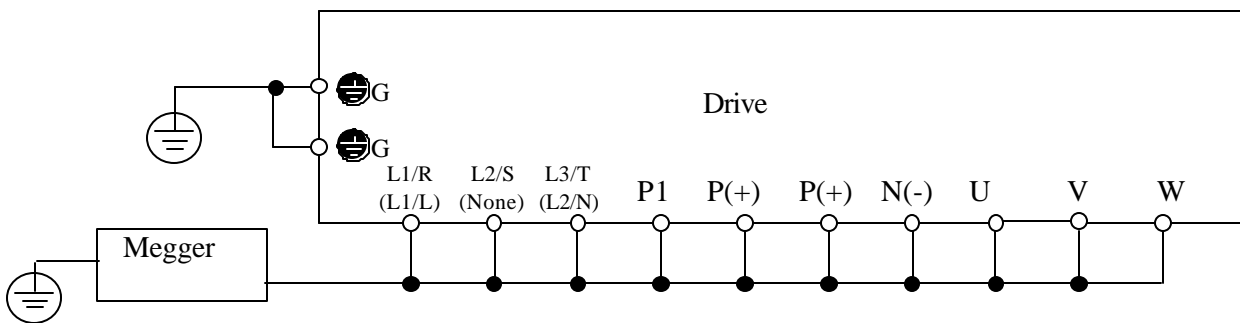


Figure 8-4-1 Megger Test

Symbols in parentheses ( ) are for the single-phase 230V series.

(2) Insulation test in the control circuit

The megger test and the dielectric strength test must not be executed in the control circuit because those parts will be damaged and cannot be repaired.

Use a high-resistance multimeter for the control circuit.

- ① Remove all external wiring from the control circuit terminals.
- ② Execute a continuity test between grounds. If the result is  $1M\Omega$  or more, it is normal.

(3) External main circuit and sequence control circuit

Remove wiring from all the terminals of the drive in order not to apply the test voltage to the drive.

## 8-5 INQUIRIES ABOUT PRODUCTS AND PRODUCT WARRANTY

### (1) Inquiries

If there is damage, a fault in the product, or questions concerning the product, contact your local distributor or GE Fuji. Be prepared to supply the following information:

- a) Drive type
- b) Serial No. (equipment serial number)
- c) Purchase date
- d) Inquiry details (e.g., damaged part, extent of damage, questions, status of fault)

### (2) Product Warranty

The warranty period is one year after purchase or 18 months from the year and month of manufacture on the nameplate, whichever expires first.

However, the guarantee will not apply in the following cases, even if the guarantee term has not expired:

1. Damage was caused by incorrect use or inappropriate repair and modification.
2. The product was used in an environment outside the standard specified range.
3. Damage was caused by dropping the product after purchase or occurred during transportation.
4. Damage was caused by an earthquake, fire, flooding, lightning, abnormal voltage or other natural calamities and secondary disasters

## 8-6 Warranty Service

The purpose of the following section is to provide specific instructions to the user of the AF-300C11 drive regarding warranty administration and how to obtain assistance on both in-warranty and out-of-warranty equipment.

If assistance is required to determine warranty status, call:

GE Fuji Drives USA, Inc.  
Salem, VA  
**1-800-533-5885**  
(24 hours)

### WARRANTY COVERAGE

Warranty period is 12 months after installation or 18 months after shipment from the Company, whichever occurs first."

However, the guarantee will not apply in the following cases, even if the guarantee term has not expired:

1. Damage was caused by incorrect use or inappropriate repair or modification.
2. The product was used in an environment outside the standard specified range.
3. Damage was caused by dropping the product after purchase or occurred during transportation.
4. Damage was caused by an earthquake, fire, flooding, lightning, abnormal voltage or other natural calamities and secondary disasters

Before calling the number at left to determine warranty status, the drive serial number will be required. This is located on the drive nameplate. If the drive is still under warranty, further information will be required per the "in Warranty Failure Checklist" shown on following page of this instruction Book.

### OUT-OF-WARRANTY PROCEDURES

When the defect has been identified, contact your local Authorized AF-300C11 Distributor to order replacement unit.

### MOTORS

Motor repairs on General Electric motors are generally handled by GE Authorized Electric Motor Servicenters or GE Apparatus Service Shops. For specific instructions on your motor, call the distributor from which it was purchased and be prepared to furnish complete nameplate data.

**IN-WARRANTY FAILURE CHECKLIST**

To assist with warranty troubleshooting, the following information is required. This data is needed to evaluate the cause in an effort to eliminate any further failures.

Model No.: \_\_\_\_\_

Serial No.: \_\_\_\_\_

Start-Up Date: \_\_\_\_\_

Failure Date: \_\_\_\_\_

Status When Failure Occurred (check one):

Power-Up \_\_\_\_\_ Running \_\_\_\_\_ Accel \_\_\_\_\_ Decel \_\_\_\_\_

Explanation of Failure \_\_\_\_\_

Application Information (check Yes or No)

Input Transformer: Yes \_\_\_\_\_ No \_\_\_\_\_

If Yes: KVA \_\_\_\_\_

L1 Volts \_\_\_\_\_ L2 Volts \_\_\_\_\_ L3 Volts \_\_\_\_\_

Power Factor Correction Capacitors: Yes \_\_\_\_\_ No \_\_\_\_\_

If Yes: Microfarrad \_\_\_\_\_

Other Equipment on Same Power Yes \_\_\_\_\_ No \_\_\_\_\_

If Yes, what?

Line Reactor on Input Yes \_\_\_\_\_ No \_\_\_\_\_

Input Starter Yes \_\_\_\_\_ No \_\_\_\_\_

Output Starter Yes \_\_\_\_\_ No \_\_\_\_\_

Motor Overloads Yes \_\_\_\_\_ No \_\_\_\_\_

Control Terminals Used (circle if used)

30A	30B	30C	FM	X1	X2	X3	FWD	REV	CM	11	12	13	C1
-----	-----	-----	----	----	----	----	-----	-----	----	----	----	----	----

Function Codes Different From Factory Settings

Function Code	Setting	Function Code	Setting

Failure Message (see Section 4)

Latest Fault \_\_\_\_\_ Previous Faults: No Message \_\_\_\_\_

Hz \_\_\_\_\_ 1. \_\_\_\_\_

A \_\_\_\_\_ 2. \_\_\_\_\_

V \_\_\_\_\_ 3. \_\_\_\_\_

After all of the Checklist information is acquired, contact the following number for assistance: (540) 387-5739

When returning failed parts, reference the C----# on the shipping documents that came with the replacement parts and ship failed parts to: GE Fuji Drives USA, Inc. · Attn: Product Service Dept. · Rm 191 · 1501 Roanoke Boulevard · Salem, VA 24153

(Marked C----#)

## 9 Specifications

### 9-1 Standard Specifications

1) Three-phase 230V input

Item		Specifications						
Drive HP		1/8	1/4	1/2	1	2	3	5
Nominal applied motor *1 (HP)		1/8	1/4	1/2	1	2	3	5
Output ratings	Rated output capacity *2 (kVA)	0.28	0.56	1.0	1.6	2.8	4.0	6.6
	Voltage(V)	3-phase, 200V/50Hz, 200, 220, 230V/60Hz (Proportional to input voltage)						
	Rated current (A)	0.7	1.4	2.5	4.0	7.0	10.0	16.5
	Overload capacity	• 150% of rated current for 1 min.						
	Rated frequency (Hz)	• 50, 60Hz						
Input power supply	Phases, Voltage, Frequency	• 3-phase 200 to 230V 50/60Hz						
	Voltage/frequency variations	• Voltage: +10% to -15% (Imbalance rate in power supply voltage: 2% or less *7) Frequency: +5% to -5%						
	Capability for voltage dip *3	• When the input voltage drops 165V or more, the drive can be operated continuously. When the input voltage drops below 165V from rated voltage, the drive can be operated for 15ms.						
	Rated input current *6 (with DCR)	0.59	0.94	1.6	3.1	5.7	8.3	14.0
	(without DCR)	1.1	1.8	3.4	6.4	11.1	16.1	25.5
Required power supply capacity *4 (kVA)	0.3	0.4	0.6	1.1	2.0	2.9	4.9	
Braking	Braking torque *5 (%)	150		100		50	30	
	DC injection braking	• Starting frequency: 3Hz(fixed), Braking current (0 to 100%), Braking current (0 to 30%)						
Protective structure (IEC60529)		• Closed type IP20						
Cooling method		• Self-cooling			• Fan cooling			
Weight (Lb)		1.3	1.3	1.5	1.8	3.3	3.3	4.9



2) Single-phase 200V input series

Item		Specifications					
Drive HP		1/8	1/4	1/2	1	2	3
Nominal applied motor *1 (HP)		1/8	1/4	1/2	1	2	3
Output ratings	Rated output capacity *2 (kVA)	0.28	0.56	1.0	1.6	2.8	4.0
	Voltage(V)	• 3-phase, 200V/50Hz, 200, 220, 230V/60Hz (Proportional to input voltage)					
	Rated current (A)	0.7	1.4	2.5	4.0	7.0	10.0
	Overload capacity	• 150% of rated current for 1 min.					
	Rated frequency (Hz)	• 50, 60Hz					
Input power supply	Phases, Voltage, Frequency	• Single-phase 200 to 240V 50/60Hz					
	Voltage/frequency variations	• Voltage: +10% to -10%, Frequency: +5% to -5%					
	Capability for voltage dip *3	• When the input voltage drops 165V or more, the drive can be operated continuously. When the input voltage drops below 165V from rated voltage, the drive can be operated for 15ms.					
	Rated input current *6 (with DCR) (without DCR)	1.2	2.0	3.5	6.5	11.8	17.7
		2.3	3.9	6.4	11.4	19.8	28.5
Required power supply capacity *4 (kVA)	0.3	0.4	0.7	1.3	2.4	3.6	
Braking	Braking torque *5 (%)	150		100		50	30
	DC injection braking	• Starting frequency: 3Hz(fixed), Braking current (0 to 100%), Braking current (0 to 30%)					
Protective structure (IEC60529)		• Closed type IP20					
Cooling method		• Self-cooling			• Fan cooling		
Weight (Lb)		1.3	1.3	1.5	2.0	3.5	4.9

Notes:

- \*1 A 4-pole standard motor is assumed as a nominal applied motor.
- \*2 Drive output capacity (kVA) at 230V.
- \*3 When a momentary power failure occurs, while rated voltage is applied 85% of load of nominal motor is given.
- \*4 When an optional power-factor correcting DC reactor is used.
- \*5 Average braking torque where an unloaded motor decelerates and stops from 60Hz operation. (Varies according to the motor efficiency)
- \*6 The specification is calculated on assumption that the drive is connected to a 500 kVA-equivalent power transformer.
- \*7 The inter-phase imbalance ratio (%) = ((Max. voltage) - (Min. voltage)) / (Average voltage among three phases) x 67

## 9-2 Common specifications

Item	Specifications	Remarks	
Output frequency Setting	Maximum output frequency	• 50 to 120Hz (in 1Hz steps)	
	Base frequency	• 25 to 120Hz (in 1Hz steps)	
	Starting frequency	• 1 to 6Hz (in 1Hz steps)	
	Carrier frequency	• 0.75 to 15kHz (Vector-distribution PWM control selectable at 7kHz or less) When operating at a carrier frequency of 9kHz or above, the frequency may automatically drop to 8kHz to protect the drive.	
Accuracy	• Analog setting: $\pm 1.0\%$ of maximum frequency (at $25 \pm 10^\circ\text{C}$ ) • Keypad panel setting: $\pm 0.01\%$ of maximum frequency (at $-10$ to $+50^\circ\text{C}$ )		
Setting resolution	• Analog setting: 1/256 of Maximum frequency • Keypad panel setting: 0.1Hz(99.9Hz or less), 1Hz(100Hz or more)		
Control	Voltage/freq. Characteristic	• Output voltage proportional to input voltage. Base frequency adjustable from 25 to 120Hz.	
	Torque boost	• Manual setting by code 0 to 31. (setting for variable torque load available)	
	Starting torque	• 150% or more (at 6Hz)	
	Control method	• Sinusoidal PWM control (with simplified current-vibration suppression)	
	Operation method	• Keypad operation: <input type="checkbox"/> RUN or <input type="checkbox"/> STOP key : Input signal: Forward/Reverse/Stop command, Coast-to-stop command, Trip command (External alarm), Alarm reset	
	Frequency setting (Multistep) (Linked operation)	• Keypad operation: ,Digital setting by <input type="checkbox"/> or <input type="checkbox"/> key • Built-in potentiometer • Analog input: 0 to +5Vdc, 0 to +10Vdc, 4 to 20mAdc • Up to 4 multistep frequencies can be set in 2-bit external signal by terminal function selection • Setting by RS485 serial communication (Option)	
	Acceleration/ deceleration time	• 0.01 to 60.0s (Independently adjustable acceleration and deceleration)	
	Frequency limiter	• High and low limits can be set for output frequency between 0 to 100% in Hz	
	Bias frequency	• The bias frequency can be set from $-100$ to $+100\%$ in Hz.	
	Gain (frequency setting signal)	• 5Vdc or 10Vdc gain can be selected.	

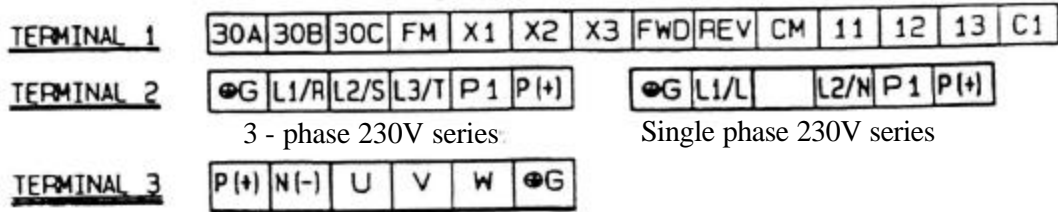
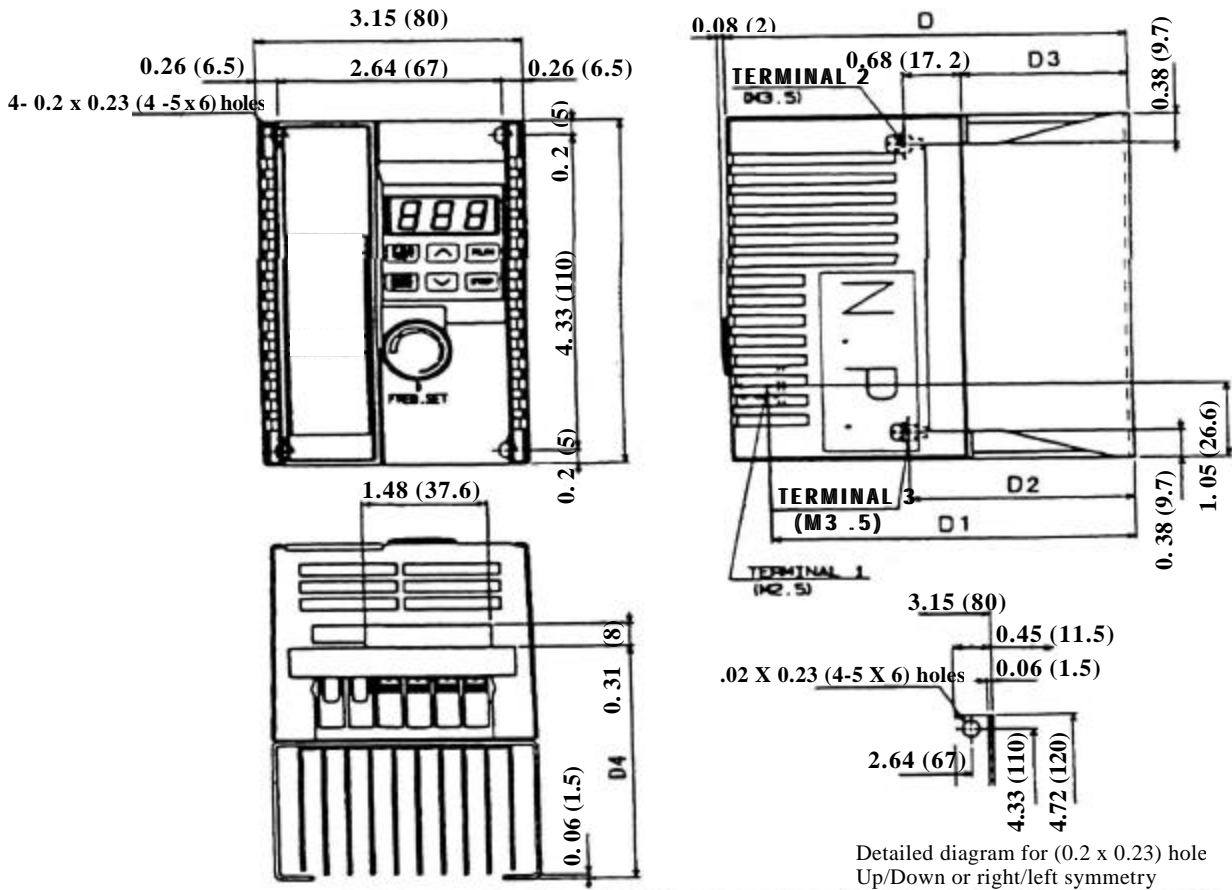
Item		Specifications	Remarks
Control	Frequency jump control	• Jump frequency (3 points) and jump hysteresis width (1 point) can be pre-set.	
	Restart after momentary power failure	• Drive restarts without causing drive-trip when power supply recovers.	
	PID control	• PID control function is provided standard.	
Enclosure (IEC 60529)		• IP20	
Cooling method		• Natural cooling for 1 HP or less, Fan cooling for 2 HP or more	
Indication	Running, stopped	• Output frequency, output current, and PID reference value/feedback value The CRG lamp is on when the capacitor is charged.	
	Program mode	• Function code and data code	
	Tripped	[Cause of trip by code] <ul style="list-style-type: none"> <li>• OC1 (Overcurrent: during acceleration)</li> <li>• OC2 (Overcurrent: during deceleration)</li> <li>• OC3 (Overcurrent: while running at constant speed)</li> <li>• OU1 (Overvoltage: during acceleration)</li> <li>• OU2 (Overvoltage: during deceleration)</li> <li>• OU3 (Overvoltage: while running at constant speed)</li> <li>• LU (Undervoltage)</li> <li>• OH1 (Overheating: Heat sink)</li> <li>• OH2 (Overheating: External alarm)</li> <li>• OL (Overload: Motor)</li> <li>• OLU (Overload: Drive)</li> <li>• Er1 (Memory error)</li> <li>• Er3 (CPU error)</li> <li>• Er6 (Operation error)</li> <li>• Er8 (RS485 communication error)</li> <li>• Lin (Input phase failure)</li> </ul>	
	Running, Tripped	• Fault history data is stored and indicated for the past four trips. Data is retained while power is off.	

Item	Specifications	Remarks	
Protection	Overload	• Internal electronic thermal overload relay protects drive overload.	
	Overvoltage	• Detect the excessive DC link circuit voltage to stop drive.	
	Overcurrent	• Detect overcurrent due to overload on drive output side to protect drive	
	Incoming surge	• Detect incoming surge voltage between AC power and the earth to protect drive.	
	Undervoltage	• Detect the DC link circuit undervoltage to stop drive	
	Overheating	• Detects the cooling fan fault or abnormal temperature rise of drive to protect drive.	
	Short-circuit	• Detect overcurrent due to short-circuit on drive output side to protect drive.	
	Ground fault	• Detects overcurrent due to ground fault on drive output side to protect drive. (Detect at starting)	
	Motor protection	• Protect general-purpose motor with electronic thermal overload.	
	Input phase failure protection (only for 3-phase 200V series)	• The drive is protected against phase failure on the input side or over-current due to inter-phase imbalance.	
	Stall prevention	<ul style="list-style-type: none"> <li>• Controls frequency to prevent OC trip in case of the output current exceeds the limit value during acceleration.</li> <li>• Lowers the frequency to hold almost constant torque in case of the output current exceeds the limit value during constant speed running.</li> <li>• Controls frequency to prevent OU trip in case of the DC link circuit voltage exceeds the limit value during deceleration.</li> </ul>	
	Retry	• “Retry” function can be set for the protective functions OC1 to OC3 and OU1 to OU3.(No. of times of retry: 5, waiting time: 0.5s fixed.	
	Dielectric strength test	• At 2000Vac for 1 min. between any main circuit terminals and ground.(10mA or less)	
Megger test	• At 500Vdc megger test between any main circuit terminals and ground (5MΩ or more)		

	Item	Specifications	Remarks
Environment	Installation location	<ul style="list-style-type: none"> <li>Indoor use only. Do not install a dusty location(Degree of pollution: 2) or expose to direct sunlight, corrosive gases, flammable gases.</li> </ul>	
	Ambient temperature	<ul style="list-style-type: none"> <li>-10 to +50°C (+14 to +122°F)</li> </ul>	
	Ambient humidity	<ul style="list-style-type: none"> <li>5 to 95%RH ( No condensation )</li> </ul>	
	Altitude	<ul style="list-style-type: none"> <li>3300 Feet (1000 m) or less</li> </ul>	
	Vibration	<ul style="list-style-type: none"> <li>3 mm: 2 to less than 9 Hz</li> <li>9.8m/s<sup>2</sup>: 9 to less than 20 Hz</li> <li>2m/s<sup>2</sup>: 20 to less than 55 Hz</li> <li>1m/s<sup>2</sup>: 55 to less than 200 Hz</li> </ul>	
	Storage temperature	<ul style="list-style-type: none"> <li>-25 to +65°C</li> </ul>	
	Storage humidity	<ul style="list-style-type: none"> <li>5 to 95% RH (No condensation)</li> </ul>	
Others	Higher harmonics current suppression	<ul style="list-style-type: none"> <li>Terminal for connecting power-factor correcting DC reactor (DCR) is provided as standard.</li> </ul>	P1, P(+) terminal
	Charging suppression resistor	<ul style="list-style-type: none"> <li>Charging suppression resistor is built-in for all drive unit.</li> </ul>	
	Cooling fan ON/OFF control	<ul style="list-style-type: none"> <li>Cooling fan can be automatically stopped when drive is stopped.</li> </ul>	

### 9-3 Dimensions

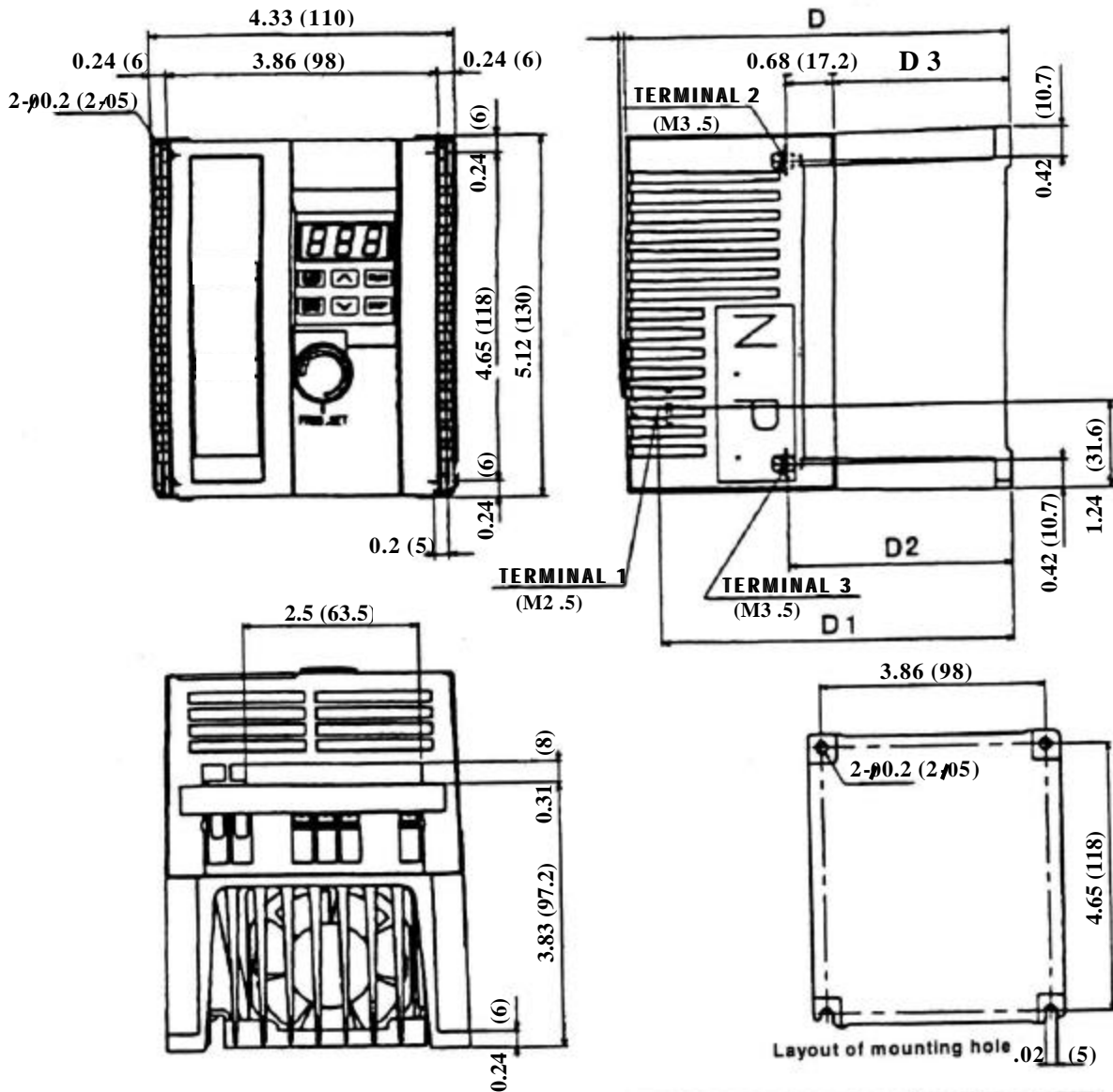
Inches (mm)



Series	Model No.	HP	Dimensions: Inches (mm)				
			D	D1	D2	D3	D4
3- phase 230V	6KC1123F12**	1/8	3.15(80)	2.70 (68.5)	1.07(27.2)	0.39(10)	1.7(43.2)
	6KC1123F25**	1/4	3.35(85)	2.89(73.5)	1.27(32.2)	0.59(15)	1.9(48.2)
	6KC1123F50**	1/2	3.74(95)	3.29(83.5)	1.66(42.2)	0.98(25)	2.29(58.2)
	6KC1123001**	1	4.72(120)	4.27(108.5)	2.65(67.2)	1.97(50)	3.28(83.2)
Single phase 200V	6KC1121F12**	1/8	3.15(80)	2.70 (68.5)	1.07(27.2)	0.39(10)	1.7(43.2)
	6KC1121F25**	1/4	3.35(85)	2.89(73.5)	1.27(32.2)	0.59(15)	1.9(48.2)
	6KC1121F50**	1/2	4.53(115)	4.07(103.5)	1.66(42.2)	0.98(25)	2.29(58.2)
	6KC1121001**	1	5.51(140)	5.06(128.5)	2.65(67.2)	1.97(50)	3.28(83.2)

\*\* Indicates product revision

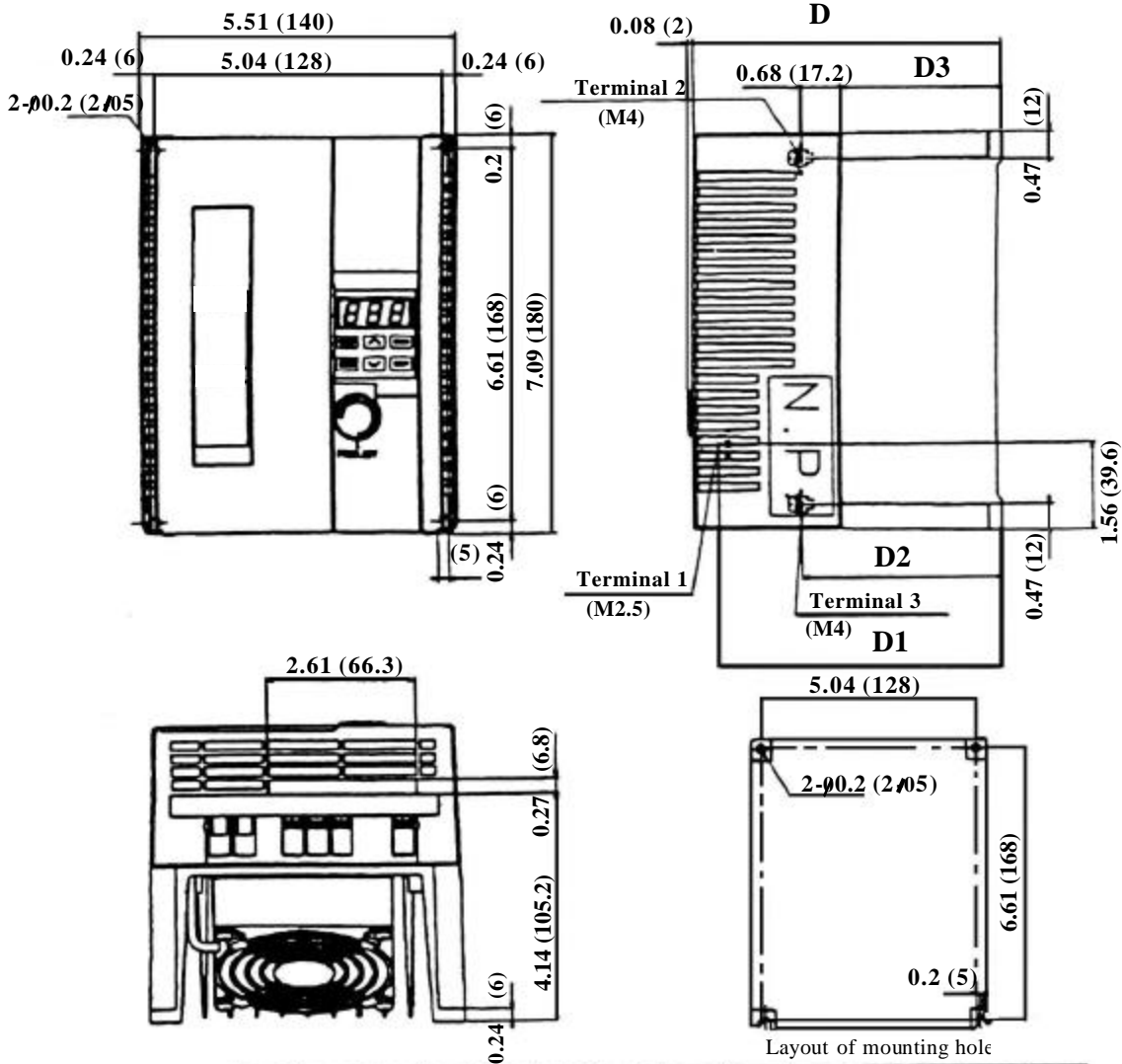
Inches (mm)



<b>TERMINAL 1</b>	30A	30B	30C	FM	X1	X2	X3	FWD	REV	CM	11	12	13	C1	
<b>TERMINAL 2</b>	⊕G	L1/R	L2/S	L3/T	P1	P(+)	⊕G		L1/L	L2/N	P1	P(+)			
	3 - phase 230V series						Single phase 230V series								
<b>TERMINAL 3</b>	P(+)	N(-)	U	V	W	⊕G									

Series	Model No.	HP	Dimensions Inches(mm)			
			D	D1	D2	D3
3- phase 230V	6KC1123002**	2	5.47 (139)	5.02 (127.5)	3.20 (81.2)	2.52 (64)
	6KC1123003**	3	5.47 (139)	5.02 (127.5)	3.20 (81.2)	2.52 (64)
Single phase 230V	6KC1121002**	2	5.87 (149)	5.41 (137.5)	3.20 (81.2)	2.52 (64)

\*\* Indicates product revision



Series	Model No.	HP	Dimensions Inches (mm)			
			D	D1	D2	D3
3- phase 230V	6KC1123005**	5	5.39(137)	4.94(125.5)	3.51(89.2)	2.83(72)
Single phase 230V	6KC1121003**	3	5.39(137)	4.94(125.5)	3.51(89.2)	2.83(72)



# 10 Options

## 10-1 Built-in Options

There is an optional built-in card for RS485 RTU serial communication. Ask at the distributor for details.

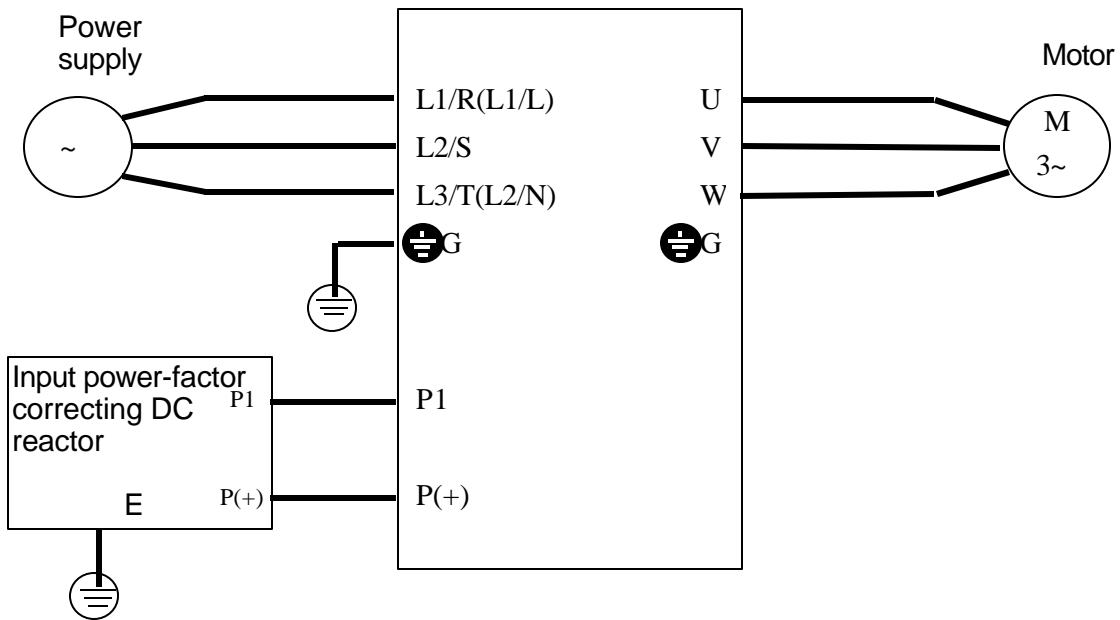
## 10-2 External Options

**Table 10-2-1 External Options**

Molded case circuit breaker	The molded case circuit breaker (MCCB) is connected for protecting the main circuit wiring to the drive and for turning power on and off. The rated current or the rated interrupting capacity varies according to the power supply specifications.
For input power-factor correcting AC reactor (ACR) DC reactor (DCR)	<p>This is connected in the following cases.</p> <p>When the power transformer capacity is more than 500 kVA.</p> <p>When the imbalance ratio between phases of source voltage exceeds 2% (The value is equivalent to our conventional allowable value.)</p> <p>Imbalance ratio between phases <math>= \frac{\text{Maximum voltage [V]} - \text{Minimum voltage [V]}}{\text{Average voltage among three phases [V]}} \times 67 [\%]</math></p> <p>To reduce input harmonic current</p> <p>The input power factor is improved to 0.75 to 0.85 (ACR).</p> <p>The input power factor is improved to 0.9 to 0.95 (DCR).</p> <p>If there is a thyristor load in the same power supply, if the capacitor for power-factor correcting is turned on or off, or if the surge voltage in the power supply is large (ACR only)</p> <p>* The AC reactor is unnecessary when the DC reactor is used.</p>
Magnetic contactor (MC)	The drive can be operated without connecting the magnetic contactor. When the drive protective function is activated, this should be connected to turn off the power for safety.
Surge absorber	This is connected to suppress the surge generated by the exciting coil when switching on or off the magnetic contactor and the control relay.
Reactor for radio noise suppression	This is used for noise suppression when the drive causes excessive noise in a radio or electronic equipment around the drive.
Frequency setting POT (VR)	This is connected when the frequency is set from the control circuit terminal using drive power.

# 11 Applicable DC reactors

## Connection method



Symbols in parentheses ( ) are for single-phase 230V series.

**Fig. 11-1-1 Connection method of Input power-factor correcting DC reactor (DCR)**

## 12 Compliance with standards

### 12-1 UL/cUL standards [Applicable to products with UL/cUL mark]

#### 12-1-1 General

The UL standards stand for Underwriters Laboratories Inc. and they are safety standards aiming at prevention of fire and other accidents in the United States, thereby providing protection for operators, service personnel and other persons.

The cUL standards are established by UL in the view of compliance with the CSA standards. The effect of products certified for the cUL standards is equal to that of products certified for the CSA standards.

#### 12-2-2 Precautions

When using the UL/cUL certified product, refer to "Compliance with UL/cUL standards" on page 1. For connection, refer to Fig. 12-1-1.

Open Type Equipment "indoor use only"

Suitable for use on a circuit capable of delivering not more than 5,000 rms symmetrical amperes, 240V maximum.

When Protected by Class J Fuses.

Use 60/75 C CU wire only.

A Class 2 circuit wired with Class 1 wire.

Field wiring connection must be made by a UL Listed and CSA Certified closed-loop terminal connector sized for the wire gauge involved. Connector must be fixed using the crimp tool specified by the connector manufacturer.

Solid state motor overload protection is provided in each model.

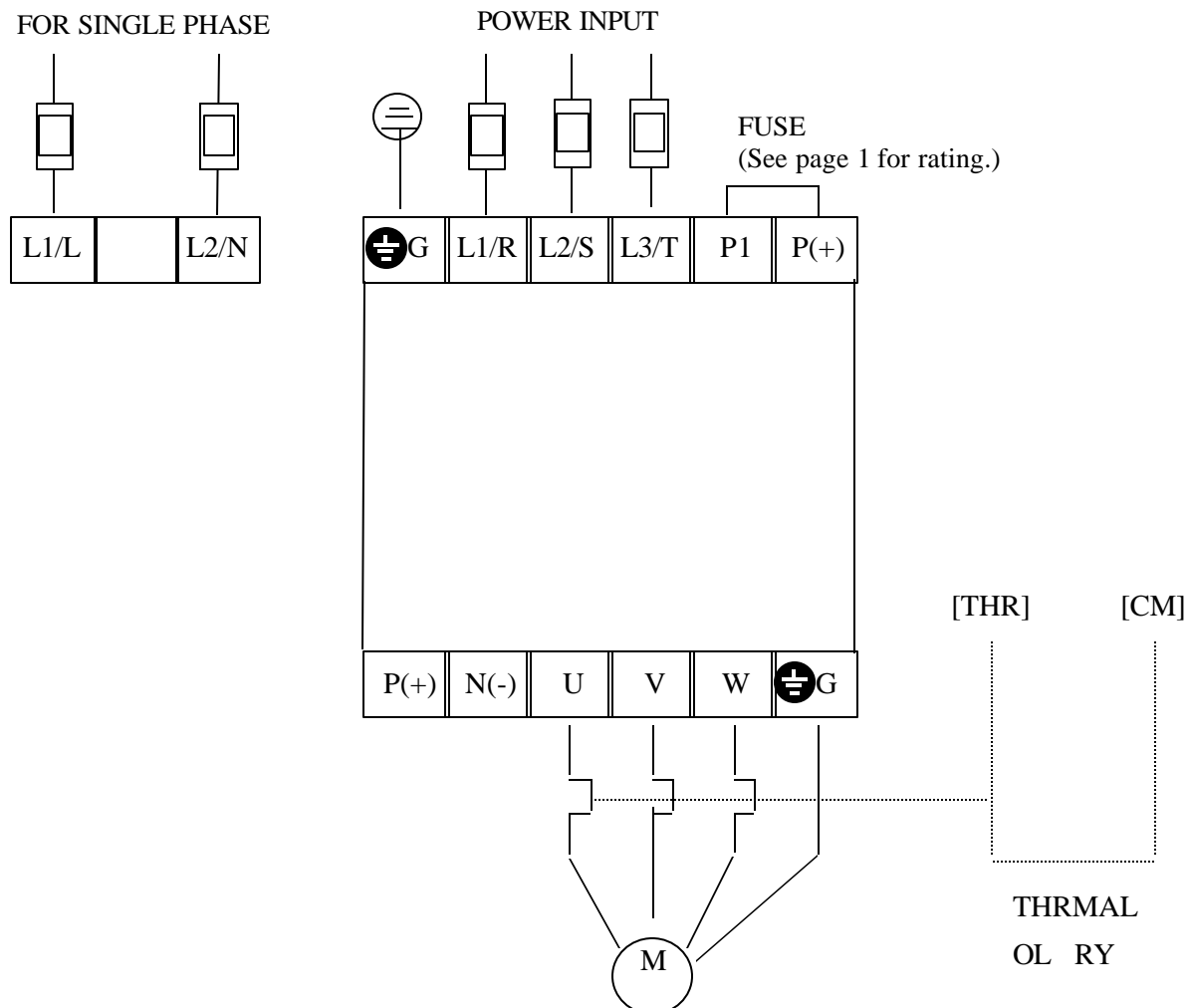


Fig. 12-1-1 Recommended wiring

## **12-2 Compliance with EMC directive in EU [Applicable to products with CE mark]**

### **12-2-1 General**

The CE mark indicated on the AF-300C11 series concerns with European minister directorate directive 89/336/EEC concerning the environmental electromagnetic compatibility EMC, and other directives are not included.

The CE mark does not prove that the entire machine or system housing our product complies with the EMC directive. Therefore indication of the CE mark to the entire machine or system will be done at the responsibility of the manufacturer or the machine. This is because:

1) The CE mark attached on our product supposes operation of the product under certain conditions. Satisfaction of the conditions is up to the manufacturer of the machine.

2) Generally speaking, various devices are used in a machine or system as well as our product. Therefore consideration for the entire machine or system must be paid by the manufacturer of the machine.

The EMC directive includes immunity to the incoming noise and emission of outgoing noise. The general purpose drive houses an internal element switching at a high speed which generates electric noise.

Applicable standards                   Immunity: EN 61800-3/1996

Emission: EN 61800-3/1996

Above-mentioned "certain conditions" include installation of a dedicated RFI filter in a metallic control panel. Refer to in exclusive Instruction Manual for RFI Filter for details.

## **12-3 Compliance with low voltage directive in EU [Applicable to products with TÜV or CE mark]**

### **12-3-1 General**

The general purpose drive is applicable for the low voltage directive in EU. Compliance of the AF-300C11 series with EN 50178/1997 has been obtained from a testing organization in EU and compliance with the low voltage directive is asserted.

### **12-3-2 Precautions**

Refer to "Compliance with low voltage directive in EU" on pages 2 and 3 when using our product as one complying with the low voltage directive in EU.

# 13 Electromagnetic Compatibility (EMC)

## 13-1 General

In accordance with the provisions described in the European Commission Guidelines Document on Council Directive 89/336/EEC, GE Fuji has chosen to classify the AF-300C11 range of Drives as "Complex Components".

Classification as a "Complex Components" allows a product to be treated as an "apparatus", and thus permits compliance with the essential requirements of the EMC Directive to be demonstrated to both an integrator of AF-300C11 Drives and to his customer or the installer and the user.

AF-300C11 Drives are supplied 'CE-marked', signifying compliance with EC Directive 89/336/EEC when fitted with specified filter units installed and grounded in accordance with this sheet.

This Specification requires the following performance criteria to be met.

EMC product standard **EN61800-3/1996**

Immunity : **Second environment** ( Industrial environment )

Emission : **First environment** ( Domestic environment )

**Finally, it is customer's responsibility to check whether the equipment conforms to EMC directive.**

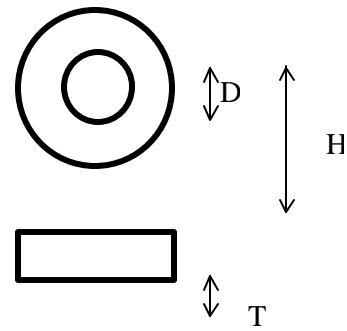
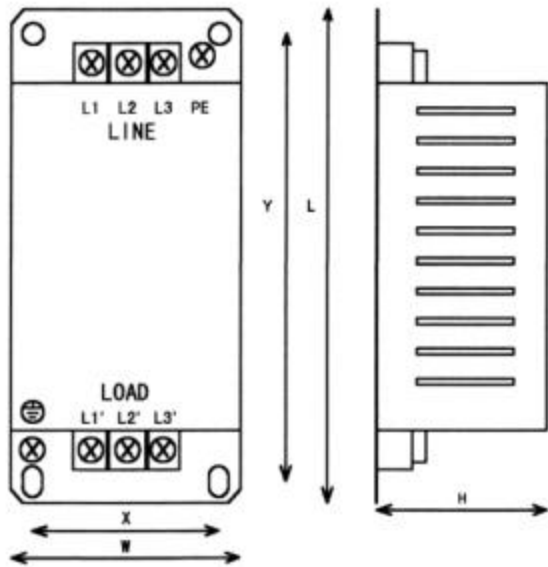
## 13-2 RFI Filters

It is strongly recommended that the appropriate AF-300C11 input filter is used, as shown in the followings, to limit RF current flowing into the main supply circuit. Without an input filter a AF-300C11 installation may not meet statutory requirement. AF-300 Drives contain high-power semi-conductor devices which are switched at high speeds to synthesize a near-sinusoidal current wave form across the frequency range of output. Rapidly-changing voltages and currents will generate some degree of electromagnetic emission. Emissions will be predominantly conducted through the motor and the mains supply cables, although some radiated emissions will be detected in close proximity to the drive system. It is essential that precautions are taken both at the design stage and at the time of installation to prevent radio frequency interference (RFI) from the drive system affecting sensitive equipment in close proximity.

The RFI filters range are designed especially for the AF-300C11 Drive and help to ensure EMC compliance of machinery an installations using the Drives. The Drives single phase series may be mounted on top of the filter using the integral fixing positions, the intention being that valuable space inside wiring cabinets may be saved. (Refer to Table 13-2-2)

**Table 13-2-1 RFI filters Dimensions**

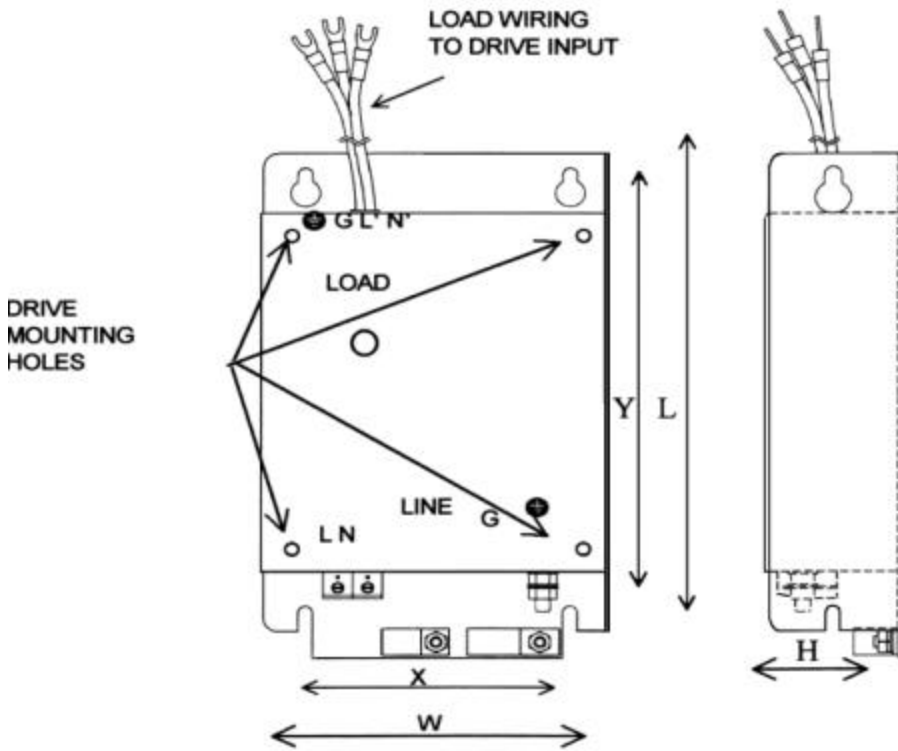
Drive HP	Filter Type	Rated Current	Max. Rated Voltage	Dimensions LxWxH (mm)	Mount Dims Y x X (mm)	Ferrite Ring	Total Weight (kg)	
Three Phase 1/8 to 1HP	EFL075SP2 (EFL-0.75SP-2)	6A	240Vac	9.57x3.35x3.66 (243x85x93)	8.98x2.32 (228x59)	OF1	3.3 (1.5)	Fig. 13-2-1
Three Phase 2 to 5HP	EFL370SP2 (EFL-3.7SP-2)	25A		9.17x4.13x5.35 (233x105x136)	8.46x3.15 (215x80)	OF2	5.5 (2.5)	
Single Phase 1/8 to 1/4HP	EFL020C117 (EFL-0.2C11-7)	4A	240Vac	7.09x3.39x1.50 (180x86x38)	--	--	1.5 (0.7)	Fig. 13-2-2
Single Phase 1/2 to 1HP	EFL075C117 (EFL-0.75C11-7)	12A		7.09x3.39x1.50 (180x86x38)	--	--	1.5 (0.7)	
Single Phase 2HP	EFL150C117 (EFL-1.5C11-7)	20A		7.48x4.61x1.81 (190x117x46)	--	--	2.6 (1.1)	
Single Phase 3HP	EFL220C117 (EFL-2.2C11-7)	29A		9.45x5.83x1.81 (240x148x46)	--	--	3.3 (1.4)	



Ferrite Ring Dimensions

Part No.	D (mm)	H (mm)	T (mm)
OF1	0.98 (25)	2.0 (51)	0.67 (17)
OF2	1.61 (41)	2.8 (71)	0.71 (18)

Fig.13-2-1



**Fig. 13-2-2**

Note : For detail, refer to the instruction manual that comes with the RFI filter.

Remark : To minimize the conducted radio disturbance in the power distribution system, the length of motor cable should be as short as possible. And it is user's responsibility to confirm that the apparatus, which the Drives installed in, conforms to EMC directive when longer motor cable is used or other installation conditions are different from those described in this manual.

### 13-3 Electromagnetic Compatibility (EMC) Recommended Installation Instructions

It is necessary that these instructions must be followed to conformed to EMC Directive.

Follow the usual safety procedures when working with electrical equipment. All electrical connections to the filter, Drive and motor must be made by a qualified electrical technician.(Refer to Fig. 13-3-1 and Fig. 13-3-2)

Use the correct filter according to Table 13-2-1.

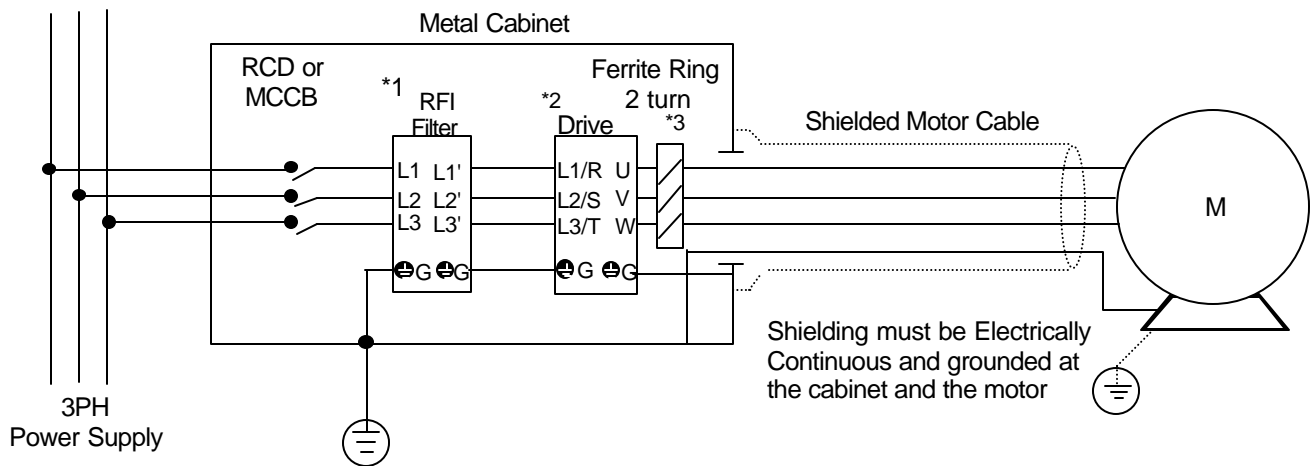
Install the Drive and filter in a electrically shielded metal cabinet.

The back panel of the wiring cabinet of board should be prepared for the mounting dimensions of the filter. Care should be taken to remove any paint etc. from the mounting holes and face area of the panel. This will ensure the best possible grounding of the filter.

Use a screened cable for the control , motor and other main wiring which are connected to the Drive. The screens should be securely grounded.

It is important that all wire lengths are kept as short as possible and that incoming mains and outgoing motor cables are kept well separated.

In case of a ferrite ring is provided with the filter, fit a ferrite ring to the motor cable with the 3 phase conductors only passing twice through the center of the ferrite.



\*1 In case of single phase power supply models, L,N,L' and N' are substituted for L1,L2,L3,L1',L2' and L3'.

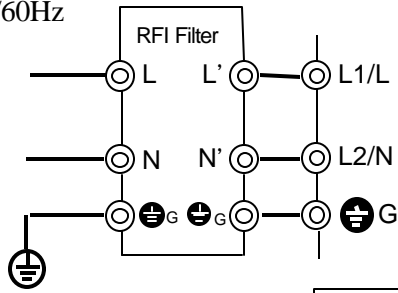
\*2 In case of single phase power supply models, L1/L and L2/N are substituted for L1/R,L2/S and L3/T.

\*3 In case of single phase power supply models, ferrite ring is unnecessary

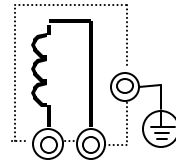
**Fig. 13-3-1 Recommended Installation**



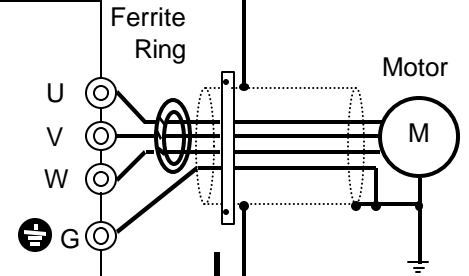
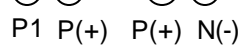
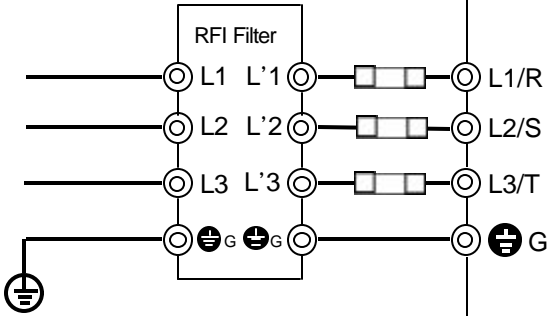
Power supply  
1-phase  
200 to 240V  
50/60Hz



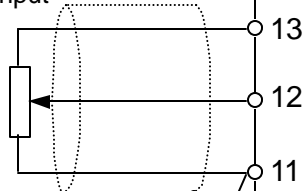
When power-factor correcting  
DC reactor is used.



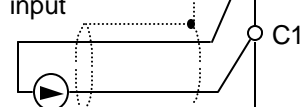
Power supply  
3-phase  
200 to 230V  
50/60Hz



Frequency setting voltage input  
(0 to +10Vdc)

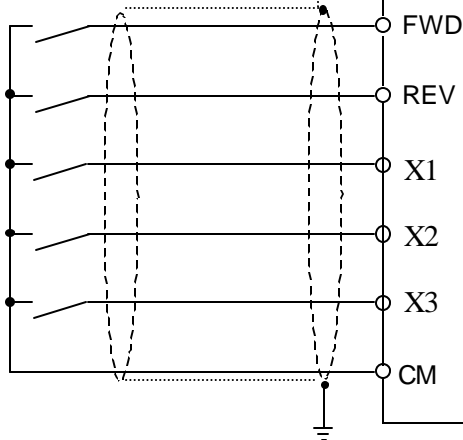


Frequency setting current input  
(4 to 20mA dc)

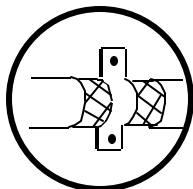
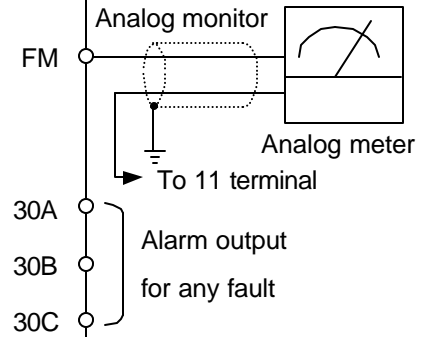


Forward operation  
command

Reverse  
operation  
command



In case of motor power cable,  
fix a part of shield by a clamp.



In case of control wires, use shielded wires  
and fix a part of shield by a clamp.

**Fig. 13-3-2 Recommended installation detail inside the enclosure**



**FUJI**  
**ELECTRIC**

*GE Fuji Drives USA, Inc.*  
*1501 Roanoke Blvd.*  
*Suite 435*  
*Salem, VA 24153*  
*1-800-543-6196*  
*[www.GEindustrial.com](http://www.GEindustrial.com)*

GEH-6640  
991213  
FERGADV  
INR-Si47-0562-E