



Read this manual first!
If you have any problems, do not attempt
to return this product to the store.
For fast help, call us first!
1-800-531-0039



Let's make things better.



PHILIPS

PHILIPS CONSUMER ELECTRONICS COMPANY

A Division of Philips Electronics
North America Corporation
Knoxville, Tennessee 37914-1810, U.S.A.

Printed in China

**CLASS 1
LASER PRODUCT**

3103 306 1888.1

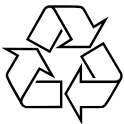

IB8369B001 – VieChr0218

IMPORTANT SAFETY INSTRUCTIONS

1. Read these instructions.
2. Keep these instructions.
3. Heed all warnings.
4. Follow all instructions.
5. Do not use this apparatus near water.
6. Clean only with dry cloth.
7. Do not block any ventilation openings. Install in accordance with the manufacturer's instructions.
8. Do not install near any heat sources such as radiators, heat registers, stoves, or other apparatus (including amplifiers) that produce heat.
9. Only use attachments/accessories specified by the manufacturer.
10.  Use only with the cart, stand, tripod, bracket, or table specified by the manufacturer or sold with the apparatus. When a cart is used, use caution when moving the cart/apparatus combination to avoid injury from tip-over.
11. Refer all servicing to qualified service personnel. Servicing is required when the apparatus has been damaged in any way, such as power-supply cord or plug is damaged, liquid has been spilled or objects have fallen into the apparatus, the apparatus has been exposed to rain or moisture, does not operate normally, or has been dropped.
12. **Battery usage CAUTION** – To prevent battery leakage which may result in bodily injury or damage to the unit:
 - Install **all** batteries correctly, + and - as marked on the unit.
 - Do not mix batteries (**old** and **new** or **carbon** and **alkaline**, etc.).
 - Remove batteries when the unit is not used for a long time.

EL 6474-E003: 01/6

Canada

English:

This digital apparatus does not exceed the Class B limits for radio noise emissions from digital apparatus as set out in the Radio Interference Regulations of the Canadian Department of Communications.

Français:

Cet appareil numérique n'émet pas de bruits radioélectriques dépassant les limites applicables aux appareils numériques de Classe B prescrites dans le Règlement sur le Brouillage Radioélectrique édicté par le Ministère des Communications du Canada.

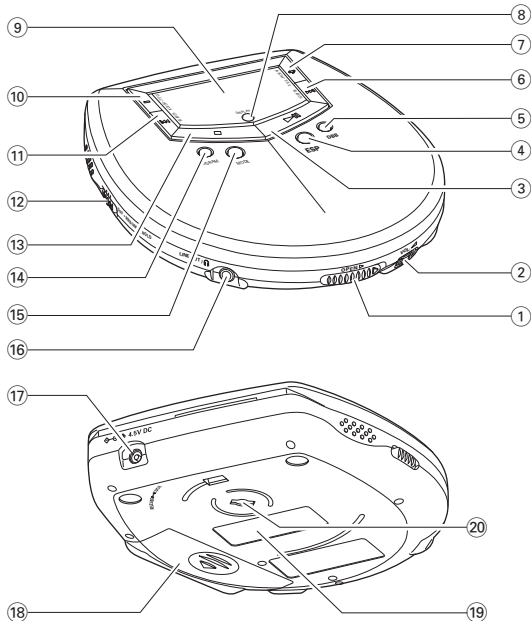

Controls

- ① **OPEN ►**
opens the CD compartment
- ② **VOL ▲**
adjusts the volume
- ③ **►||**
switches on the unit, starts playback, and pauses playback
- ④ **ESP**
Electronic **S**kipping **P**rotection prevents music interruptions caused by shocks or vibrations
- ⑤ **DBB**
Dynamical **B**ass **B**oost, selects the bass enhancement
- ⑥ **►►**
skips forward and searches forward
- ⑦ **+**
MP3-CD only: selects the next album or skips forward
- ⑧ **DISPLAY**
selects the track and album information for MP3-CDs
- ⑨ **display**
- ⑩ **-**
MP3-CD only: selects the previous album or skips backward
- ⑪ **◄◄**
skips backward and searches backward
- ⑫ **OFF · RESUME · HOLD**
OFF switches off RESUME and HOLD; RESUME stores the last position played; HOLD locks all buttons
- ⑬ **■**
stops playback, clears a program and switches off the unit

Quick start

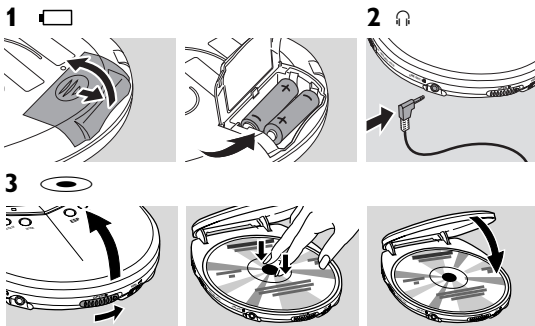

- ⑭ **PROGRAM**
programs tracks and lets you review the program
- ⑮ **MODE**
selects playback options such as **SHUFFLE** and **REPEAT**
- ⑯ **LINE OUT/◄**
3.5 mm line out jack to connect
– the headphones
– this unit to the audio input of your stereo equipment
- ⑰ **4.5V DC**
to connect the power adapter (supplied or optionally available)
- ⑱ battery compartment
- ⑲ type plate
- ⑳ belt clip hole

CAUTION

Use of controls or adjustments or performance of procedures other than herein may result in hazardous radiation exposure or other unsafe operation.

The set complies with the FCC-Rules, Part 15 and with 21 CFR 1040.10. Operation is subject to the following two conditions:

1. This device may not cause harmful interference, and
2. This device must accept any interference received, including interference that may cause undesired operation.

Maintenance

Do not touch the lens (A) of the unit.

Do not expose the unit, batteries or discs to humidity, rain, sand or excessive heat (caused by heating equipment or direct sunlight).

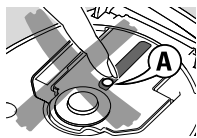

The lens may cloud over when the unit is suddenly moved from cold to warm surroundings. Playing is not possible then. Leave the unit in a warm environment until the moisture evaporates.

Active mobile phones in the vicinity of this unit may cause malfunctions.

Avoid dropping the unit; this may cause damage.

Clean the unit with a soft, slightly dampened lint-free cloth. Do not use any cleaning agents; they may have a corrosive effect.

To clean a disc, wipe it in a straight line from the center toward the edge using a soft, lint-free cloth. Cleaning agents may damage the disc.

Environmental information

All redundant packing material has been omitted. We have done our utmost to make the packaging easily separable into three mono materials: cardboard (box), polystyrene foam (buffer) and polyethylene (bags, protective foam sheet).

Your unit consists of materials which can be recycled if disassembled by a specialized company. Please observe the local regulations regarding the disposal of packing materials, exhausted batteries and old equipment.

MP3 music files

The music compression technology MP3 (MPEG 1 Audio Layer 3) reduces the digital data of an audio CD significantly while maintaining CD-like sound quality. With MP3 you can record up to 10 hours of CD-like music on a single CD-ROM.

How to get music files

Either download legal music files from the internet to your computer hard disc or create them from your own audio CDs. For this, insert an audio CD into your computer's CD-ROM drive and convert the music using an appropriate encoder software. To achieve a good sound quality, a bit rate of 128 kbps or higher is recommended for MP3 music files.

Batteries (supplied or optionally available)

Inserting batteries

- Open the battery compartment and insert 2 alkaline batteries of type **AA (LR6, UM3)**.

Do not mix old and new or different types of batteries.

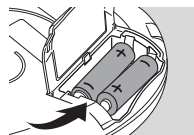

Indication of empty batteries

- Replace the batteries or connect the power adapter as soon as  blinks and **REPLACE BATTERIES** is scrolled.



Remove batteries if they are empty or if the unit will not be used for a long time.

Batteries contain chemical substances, so they should be disposed of properly.

Average playing time of 2 alkaline batteries under normal conditions:

	Audio disc	MP3-CD
ESP on	11 hours	11 hours
ESP and powersaving on	15 hours	23 hours

Headphones

- Connect the supplied headphones to **LINE OUT**/.

Note: LINE OUT/ can also be used for connecting this unit to your HiFi system. Set VOL  on this unit to position 8 and adjust volume and sound with your HiFi system.

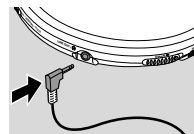

Use your head when using headphones

Hearing safety

Do not play your headset at a high volume. Hearing experts advise against continuous extended play. If you experience a ringing in your ears, reduce the volume or discontinue use.

Traffic safety

Do not use while operating a motorized vehicle. It may create a traffic hazard and it's illegal in many areas. You should use extreme caution or temporarily discontinue use in potentially hazardous situations. Even if your headset is an open-air type designed to let you hear outside sounds, don't turn up the volume so high that you can't hear what's around you.

How to organize music files

In order to easily handle the large number of music files on a CD-ROM, you can organize them in folders ("albums").

The tracks of an album will be played in alphabetical order. If you want to arrange them in a certain order, let the file names start with numbers. For example:

001-ONEWORLD.MP3

002-FIRESTARTER.MP3

003-DEEPM3

Albums will be arranged in alphabetical order, but subfolders (albums within another album) will be played immediately after the album in which they are located. Albums without MP3 files will be skipped.

If there are MP3 files which you did not put into an album, you will find them in the album *VARIOUS* with album number 0. *VARIOUS* is the first album that will be played.

When playing a disc with CD Audio tracks and MP3 files, the CD Audio tracks will be played first.

How to make a CD-ROM with MP3 files

Use your computer's CD burner to record ("burn") the music files from your hard disc on a CD-ROM. Use either ISO 9660 disc format or UDF. Some CD burner software like e. g. "DirectCD" support the UDF format.

Make sure that the file names of the MP3 files end with .mp3.

Supported formats

This unit supports:

- Disc format: ISO 9660, Joliet, Multisession, UDF, Enhanced Music CD, Mixed Mode CD
- MP3 bit rate: 32–320 kbps and variable bit rate
- Total number of music files and albums: around 350 (with a typical file name length of 20 characters)

Note: The number of music files that can be played depends on the length of the file names. With short file names more files will be supported.

All trademarks used are owned by their respective owners.

Power adapter (supplied or optionally available)

Use only the AY 3170 power adapter (4.5 V/300 mA direct current, positive pole to the center pin). Any other product may damage the unit.

- 1 Make sure the local voltage corresponds to the adapter's voltage.
- 2 Connect the power adapter to 4.5V DC on the unit and to the power outlet.

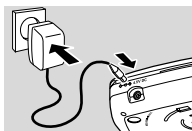

Note: Always disconnect the adapter if you are not using it.

Playing a disc

With this unit you can play

- audio discs (pre-recorded audio CDs, finalized audio CDRs and CDRWs)
- MP3-CDs (CD-ROMs with MP3 files)

- 1 Push the OPEN ► slider to open the CD compartment.
- 2 Insert a disc, printed side up, by pressing gently on the disc's center so that it fits onto the hub. Close the CD compartment by pressing it down.
- 3 Press ► to start playback.
→ **REPEAT** [] is displayed. Playback starts.
Audio disc: The current track number and the elapsed playing time are displayed.
MP3-CD: The filename is scrolled once.
- 4 To interrupt playback, press ►. → The elapsed playing time blinks.
- 5 To resume playback, press ► again.

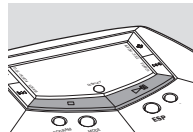
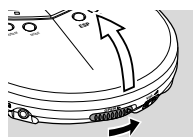

- 6 To stop playback, press ■.
→ **Audio disc:** The number of tracks and the total playing time of the disc are displayed.
MP3-CD: The number of albums and the number of tracks are displayed.
- 7 To remove the disc, hold it by its edge and press the hub gently while lifting the disc.

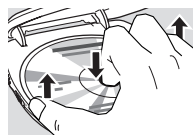

Notes:

After pressing ► it may take some time until the first MP3 track is played.

The display switches off 20 seconds after pressing ■. After 90 seconds the unit switches off automatically.

Volume adjustment

- Adjust the volume by using VOL ▲.

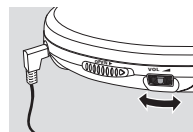

Sound adjustment

- 1 Press **DBB** for a moderate bass enhancement.
→ **DBB** appears and **DBB 1** is displayed.
- 2 Press **DBB** again for a strong bass enhancement.
→ **DBB** appears and **DBB 2** is displayed.
- 3 Press **DBB** again to switch off the bass enhancement.
→ **DBB** disappears and **DBB OFF** is displayed.

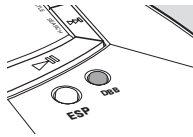

Beep

A beep confirms that you have pressed a button or that the batteries are empty.

- Keep **DBB** pressed for 2 seconds to switch beep either on or off:
→ **BEEP** is displayed: Beep is switched on.
→ **NO BEEP** is displayed: Beep is switched off.



Selecting and searching on all discs

Selecting a track during playback

- Briefly press **◀** or **▶** once or several times to skip to the beginning of the current, previous or subsequent track.
→ Playback continues with the selected track.

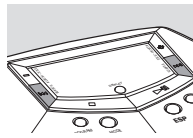

Searching for a passage during playback

- 1 Keep **◀** or **▶** pressed to find a particular passage in backward or forward direction.
→ Searching starts and playback continues at a low volume.
- 2 Release the button at the desired passage.
→ Normal playback continues.

*Note: During **SHUFFLE ALBUM**, **SHUFFLE ALL**, **REPEAT SHUFFLE ALBUM**, **REPEAT SHUFFLE ALL**, **REPEAT**, **REPEAT ALBUM** or while playing a program, searching is only possible within the current track.*

Track and album information (for MP3 tracks only)

- Press **DISPLAY** repeatedly during playback to select the following track information:
 - the track number and the elapsed playing time,
 - **ALBUM**: the album's folder name,
 - **ARTIST**: the artist's name (if this ID3 tag information is available),
 - **TITLE**: the track's title (if this ID3 tag information is available),
 - **FILENAME**: the track's file name.

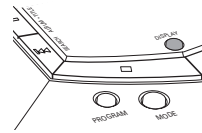

Note: The ID3 tag is part of an MP3 file and contains various track information such as the track's title or the artist's name. Complete the ID3 tag information with your MP3 encoder software before burning the MP3-CD.

Playing tracks repeatedly or in random order

- 1 Press **MODE** repeatedly during playback to select either:
 - **SHUFFLE ALBUM** (with MP3-CDs only): All tracks of the current album are played in random order once.
 - **SHUFFLE ALL**: All tracks of the disc are played in random order once.
 - **REPEAT SHUFFLE ALBUM** (with MP3-CDs only): All tracks of the current album are played repeatedly in random order.
 - **REPEAT SHUFFLE ALL**: All tracks of the disc are played repeatedly in random order.
 - **REPEAT**: The current track is played repeatedly.
 - **REPEAT ALBUM** (with MP3-CDs only): All tracks of the current album are played repeatedly.
 - **REPEAT ALL**: The entire disc is played repeatedly.
 → Playback starts in the selected mode after 2 seconds.
- 2 To return to normal playback, press **MODE** repeatedly until **REPEAT** and **SHUFFLE** disappear.

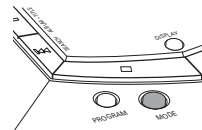

*Note: While playing a program, you can select either **SHUFFLE PROGRAM**, **SHUFFLE REPEAT PROGRAM** or **REPEAT PROGRAM**.*

Selecting albums and tracks on MP3-CDs

Selecting an album during playback

- Briefly press **-** or **+** once or several times to skip to the first track of the current, previous or subsequent album.

→ The first track of the selected album is played.

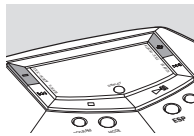

Selecting a track during playback

- 1 Keep **-** or **+** pressed to skip quickly to previous or subsequent MP3 tracks.
→ Skipping starts and speeds up after 5 seconds.
- 2 Release the button at the desired track.
→ Playback continues with the selected track.

Note: To skip from track to track at low speed, use **◀◀** or **▶▶**.

Programming track numbers

You can select up to 50 tracks and store them in the memory in a desired sequence. You can store any track more than once.

- 1 Select a track with **◀◀**, **▶▶**, **-** or **+**.
- 2 Press **PROGRAM** to store the track.
→ **PROGRAM** appears and **P** with the number of stored tracks is displayed.

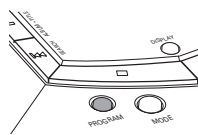

- 3 Select and store all desired tracks in this way.
- 4 If necessary press **■** to stop normal playback. Press **▶▶** to start playback of the program.



- To add additional tracks to the program, stop playback of the program by pressing **■** and continue with step 1.
- To review the program, keep **PROGRAM** pressed for more than 3 seconds.
→ All stored tracks are displayed in sequence.

Storing the last position played – RESUME

You can store the last position played. When restarting, playback will continue from where you have stopped.

- 1 Switch the slider to **RESUME** during playback to activate **RESUME**.
→ **RESUME** appears.

- 2 Press **■** whenever you want to stop playback.

- 3 Press **▶▶** to resume playback.
→ Playback continues from where you have stopped.

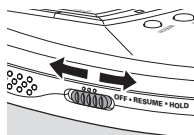

- To deactivate **RESUME**, switch the slider to **OFF**.
→ **RESUME** disappears.

Locking all buttons – HOLD

You can lock all buttons of the unit. When you press any button, no action will take place.

- Switch the slider to **HOLD** to activate **HOLD**.
→ **RESUME** appears and **HOLD** is displayed. All buttons are locked. When pressing any button, **HOLD** is displayed.

- To deactivate **HOLD**, switch the slider to **OFF**.
→ **RESUME** disappears.

Clearing the program

- 1 If necessary press **■** to stop playback.

- 2 Press **■** to clear the program.
→ **PROGRAM CLEARED** is scrolled, **PROGRAM** disappears and the program is cleared.



Notes:

The program will also be cleared if you interrupt the power supply or open the CD compartment or if the unit switches off automatically.

After storing 50 tracks, **PROGRAM FULL** is scrolled.

Belt clip

- 1 Align the belt clip as indicated in the illustration and press on the clip to insert its shaped pin into the hole in the unit.

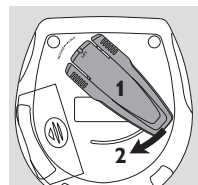

- 2 Turn the clip clockwise as indicated to lock the belt clip to the unit.

- To detach, gently lift the belt clip where **LIFT** is indicated and turn it counter-clockwise.

In-car connections (supplied or optionally available)

Use only the AY 3545 or AY 3548 car voltage converter (4.5V DC, positive pole to the center pin) and the AY 3501 car adapter cassette. Any other product may damage the unit.

- Put the unit on a horizontal, vibration-free and stable surface. Make sure it is in a safe place, where the unit is neither a danger nor an obstacle to the driver and the passengers.
- Plug the voltage converter into the cigarette lighter jack (only for a 12V car battery, negative grounding), then connect the wired end to the 4.5V DC input jack on the unit.
- If necessary, clean the cigarette lighter jack to obtain a good electrical contact.
- Turn down the volume and connect the adapter cassette plug to LINE OUT/⌚ on the unit.
- Carefully insert the adapter cassette into the car radio's cassette compartment.
- Make sure the cord does not hinder your driving.
- Set VOL  on the unit to position 8. Start playback on the unit and adjust the sound with the car radio controls.

Always remove the voltage converter from the cigarette lighter jack when the unit is not in use.

Note: If your car radio has a LINE IN jack, it is better to connect the unit to this jack instead of using the adapter cassette. Connect LINE OUT/⌚ of the unit with the LINE IN jack of your car radio with an appropriate cable.

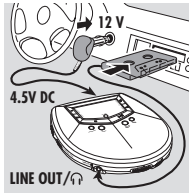

WARNING

Under no circumstances should you try to repair the unit yourself as this will invalidate the guarantee. If a fault occurs, first check the points listed, before taking the unit for repair. If you are unable to solve a problem by following these hints, consult your dealer or service center.

Problem	Solution
No power, playback does not start	<ul style="list-style-type: none"> – Insert the batteries correctly. – Replace the batteries. – Connect the power adapter securely.

ESP and powersaving

With a conventional portable disc player the music may skip or stop if the player is shaken or jarred. The **Electronic Skip Protection** protects this unit against loss of sound caused by light vibrations or shocks. Continuous playback is ensured.

ESP does not protect the unit against damage caused by dropping! Powersaving increases the battery playing time.

- Press ESP repeatedly during playback to switch ESP and powersaving on or off:
 - **ESP ON:** **ESP** appears. ESP is switched on.
 - **ESP OFF:** **ESP** disappears. ESP is switched off to achieve the highest sound quality for CD Audio tracks.
 - **POWERSAVING:** **ESP+LP** appears. ESP and powersaving are switched on. The battery playing time is increased and the skip protection time slightly decreased.

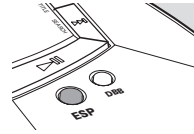

Return your Warranty Registration card today to ensure you receive all the benefits you're entitled to.

- Once your Philips purchase is registered, you're eligible to receive all the privileges of owning a Philips product.
- So complete and return the Warranty Registration Card enclosed with your purchase at once, and take advantage of these important benefits.

Warranty Verification

Registering your product within 10 days confirms your right to maximum protection under the terms and conditions of your Philips warranty.

Owner Confirmation

Your completed Warranty Registration Card serves as verification of ownership in the event of product theft or loss.

Model Registration

Returning your Warranty Registration Card right away guarantees you'll receive all the information and special offers which you qualify for as the owner of your model.

Know these *safety* symbols



 This "bolt of lightning" indicates uninsulated material within your unit may cause an electrical shock. For the safety of everyone in your household, please do not remove product covering.

 The "exclamation point" calls attention to features for which you should read the enclosed literature closely to prevent operating and maintenance problems.

For Customer Use

Enter below the Serial No. which is located on the rear of the cabinet. Retain this information for future reference.

Model No. _____
Serial No. _____

WARNING: TO PREVENT FIRE OR SHOCK HAZARD, DO NOT EXPOSE THIS EQUIPMENT TO RAIN OR MOISTURE.

CAUTION: To prevent electric shock, match wide blade of plug to wide slot, and fully insert.

Problem	Solution
No sound or bad sound quality	<ul style="list-style-type: none"> – Press ▶II to resume playback. – Adjust the volume. – Check and clean the connections. – Keep this unit away from active mobile phones or strong magnetic fields.
The disc skips tracks	<ul style="list-style-type: none"> – Clean or replace the disc. – Make sure REPEAT, SHUFFLE or PROGRAM are not selected.
HOLD indication and/or no reaction to controls	<ul style="list-style-type: none"> – Deactivate HOLD. – Disconnect the unit from the power supply or take out the batteries for a few seconds.
INSERT CD or NO AUDIO FILE indication	<ul style="list-style-type: none"> – Insert a disc, label upwards. – Clean or replace the disc. – Wait until the steamed up lens clears. – Make sure you have inserted an audio disc or an MP3-CD.
UNFINALIZED CD indication	<ul style="list-style-type: none"> – Make sure the inserted CDR or CDRW is finalized.
OOFS indication	<ul style="list-style-type: none"> – Switch on ESP.

Problem	Solution
Music file is not played	<ul style="list-style-type: none"> – Make sure the file names of the MP3 files end with .mp3
Missing directories on MP3-CD	<ul style="list-style-type: none"> – Make sure the total number of files and albums on your MP3-CD does not exceed 350. – Only albums with MP3 files are shown.
Music skips or popping sound when playing an MP3 file	<ul style="list-style-type: none"> – Play the music file on your computer. If the problem persists, encode the audio track again and make a new CD-ROM.
In-car use: No power, playback does not start	<ul style="list-style-type: none"> – Clean the cigarette lighter socket. – Switch on the ignition of your car.
In-car use: No sound or bad sound	<ul style="list-style-type: none"> – Insert the adapter cassette correctly. – Change the autoreverse direction of your car cassette player. – Let the set adjust to the temperature in the car.

LIMITED WARRANTY

PORTABLE COMPACT DISC

One Year Free Exchange
This product must be carried in for an exchange.

WHO IS COVERED?

You must have proof of purchase to exchange the product. A sales receipt or other document showing that you purchased the product is considered proof of purchase. Attach it to this owner's manual and keep both nearby.

WHAT IS COVERED?

Warranty coverage begins the day you buy your product. For one year thereafter, a defective or inoperative product will be replaced with a new, renewed or comparable product at no charge to you. A replacement product is covered only for the original warranty period. When the warranty on the original product expires, the warranty on the replacement product also expires.

WHAT IS EXCLUDED?

Your warranty does not cover:

- labor charges for installation or setup of the product, adjustment of customer controls on the product, and installation or repair of antenna systems outside of the product.
- product repair and/or part replacement because of misuse, accident, unauthorized repair or other cause not within the control of Philips Consumer Electronics Company.
- reception problems caused by signal conditions or cable or antenna systems outside the unit.
- a product that requires modification or adaptation to enable it to operate in any country other than the country for which it was designed, manufactured, approved and/or authorized, or repair of products damaged by these modifications.
- incidental or consequential damages resulting from the product. (Some states do not allow the exclusion of incidental or consequential damages, so the above exclusion may not apply to you. This includes, but is not limited to, prerecorded material, whether copyrighted or not copyrighted.)
- a product that is used for commercial or institutional purposes.

WHERE IS EXCHANGE AVAILABLE?

You may exchange the product in all countries where the product is officially distributed by Philips Consumer Electronics Company. In countries where Philips Consumer Electronics Company does not distribute the product, the local Philips service organization will attempt to provide a replacement product (although there may be a delay if the appropriate product is not readily available).

Philips, P.O. Box 520890, Miami,
FL 33152, USA, (402) 536-4171

BEFORE REQUESTING EXCHANGE...

Please check your owner's manual before requesting an exchange. Adjustments of the controls discussed there may save you a trip.

EXCHANGING A PRODUCT IN U.S.A., PUERTO RICO OR U.S. VIRGIN ISLANDS...

Contact 1-800-531-0039 to arrange an exchange. Or, ship the product, insured and freight prepaid, and with proof of purchase enclosed, to the address listed below.

Philips Exchange Program
Suite A
406 North Irish Street
Greenville TN 37745

(In U.S.A., Puerto Rico and U.S. Virgin Islands, all implied warranties, including implied warranties of merchantability and fitness for a particular purpose, are limited in duration to the duration of this express warranty. But, because some states do not allow limitations on how long an implied warranty may last, this limitation may not apply to you.)

EXCHANGING A PRODUCT IN CANADA...

Please contact Philips at:

1-800-661-6162 (French Speaking)
1-800-531-0039 (English Speaking)

(In Canada, this warranty is given in lieu of all other warranties. No other warranties are expressed or implied, including any implied warranties of merchantability or fitness for a particular purpose. Philips is not liable under any circumstances for any direct, indirect, special, incidental or consequential damages, howsoever incurred, even if notified of the possibility of such damages.)

REMEMBER...

Please record the model and serial numbers found on the product below. Also, please fill out and mail your warranty registration card promptly. It will be easier for us to notify you if necessary.

MODEL # _____

SERIAL # _____

This warranty gives you specific legal rights. You may have other rights which vary from state/province to state/province.