

WARRANTY

Crosley Radio Products are warranted against defects in material and workmanship for a period of 90 days beginning from the date of sale to the original purchaser.

Should the unit fail under normal usage during the 90 day warranty period, a request for RETURN AUTHORIZATION (R.A.) must be made by the original customer before returning the unit. Call Crosley Radio customer service for Return Authorization at (502) 583-4246 from 9 AM to 5 PM (EST) Monday to Friday.

Upon receiving the RETURN AUTHORIZATION number from the Customer Service Department, properly pack your unit in its original packaging. Include any adapters, parts, & accessories which were originally provided with the product, along with a check or money order for \$19.95 made out to Crosley Radio to cover the handling and return postage. Display the R.A. # on the outside of the carton and ship PREPAID via standard UPS or its equivalent.

CROSLEY
RADIO

ATTN: RETURNS DEP'T
2001 PRODUCTION DRIVE
BAY 2 & 3
LOUISVILLE, KY 40299

CROSLEY RADIO assumes no responsibility for units sent without prior Return Authorization.

The purchaser's bill of sale is the only proof of warranty entitlement and must accompany the unit.

The warranty does not cover damage due to acts of nature, accident, misuse, abuse, negligence, commercial use or modification of, or to any part of the product. This warranty does not cover damage due to improper operation or maintenance, connection to improper voltage supply, or attempted repair by anyone other than a facility authorized by Crosley Radio to service the product. This warranty does not cover products sold AS IS or consumables (such as fuses or batteries). This warranty is valid only in the United States.

This warranty gives the purchaser specified legal rights in addition to any rights which may vary from state to state.

In accordance with the "Moss-Magnuson Warranty Act" of July 10, 1975, this is termed a "limited warranty" which in no way compromises Crosley Radio, high standards of Quality and Workmanship.

CROSLEY
RADIO

CR245

Director CD Recorder

Instruction Manual

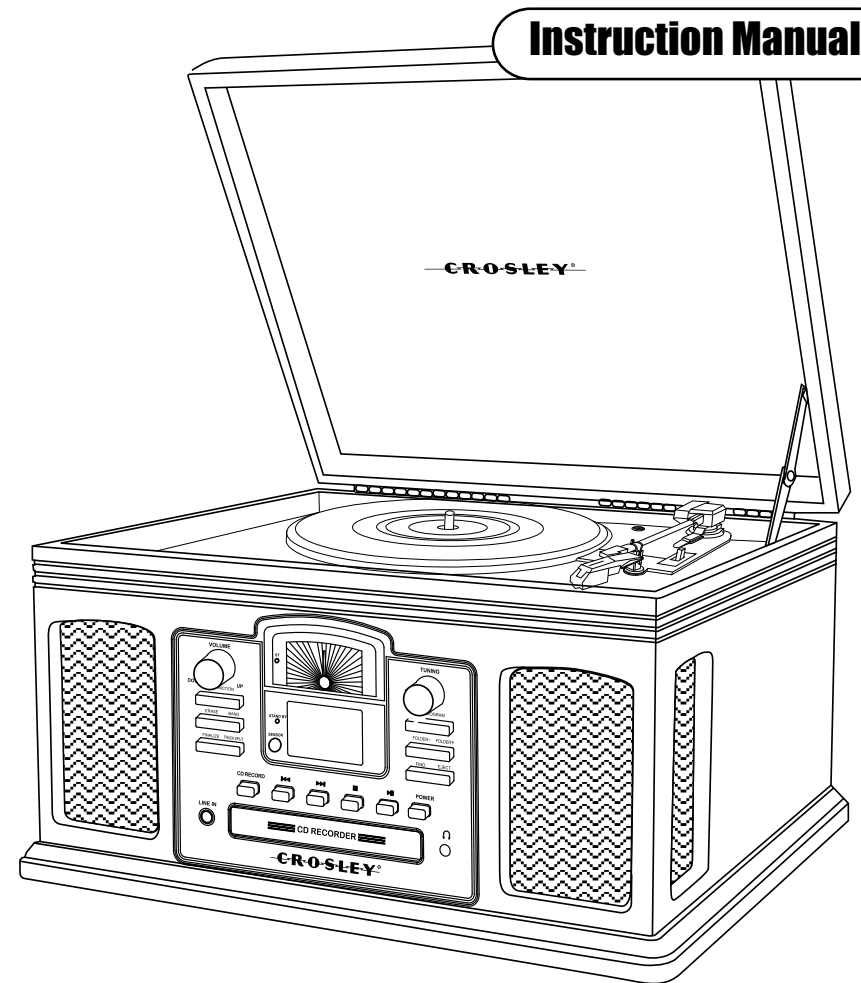

Audio / Connections

Audio Connections

Aux Input

Using the Aux Input allows you to hook up additional external audio components and listen to them through your unit. Any component with an audio output such as a Tuner, can be connected by using the correct cables (not included). This unit uses standard RCA cables. Simply plug the red and white connectors on one end of the cable to the red and white Aux In jacks on the back of your unit. The other end of the cable will plug into the Audio Output jack on the external component. For more information on hooking up the external component, see the owner's manual for that component.

Audio Output

Using the Audio Output will allow you to run the audio from your unit into a home stereo, television or other stereo source. To make this connection, you will need standard RCA cables. Plug the red and white connectors on one end of the cable into the red and white Audio Output jacks on the back of the unit. The other end of the cable will plug into the Aux Input jacks of your selected component. For more information on hooking up to the external component, see the owner's manual for that component.

NOTE: You can still listen to your unit when using the Audio Output feature

Line In Jack

The Line In Jack is located on the front of your unit. This jack uses a 3.5 mm mini pin cable for connection. This connection is especially useful in hooking up smaller audio components like MP3 players. To make this connection, you will need a 3.5mm audio cable (not included). Hook one end of the cable into the Line In Jack on the front of your unit. The other end will plug into the Audio Output or headphone jack on the selected component. For more information on hooking up the external component, see the owners manual for that component.

Audio Output

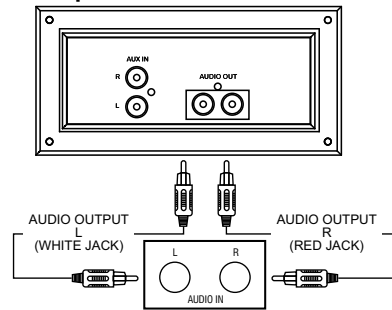

Aux Input

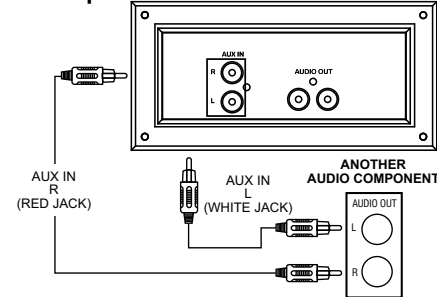

WARNING:

TO PREVENT FIRE OR SHOCK HAZARD, DO NOT EXPOSE THIS APPLIANCE TO RAIN OR MOISTURE. DO NOT REMOVE COVER. PILOT LAMPS SOLDERED IN PLACE. NO USER SERVICEABLE PARTS INSIDE. REFER SERVICING TO QUALIFIED SERVICE PERSONNEL.

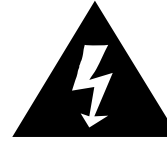

The lightning flash with arrowhead symbol, within an equilateral triangle, is intended to alert user to the presence of uninsulated "dangerous voltage" within the product's enclosure that may be of sufficient magnitude to constitute risk of electric shock to persons.

CAUTION

**RISK OF ELECTRIC SHOCK
DO NOT OPEN**

CAUTION: TO REDUCE THE RISK OF ELECTRIC SHOCK, DO NOT REMOVE COVER (OR BACK). NO USER - SERVICEABLE PARTS INSIDE. REFER SERVICING TO QUALIFIED SERVICE PERSONNEL.



The exclamation point within an equilateral triangle is intended to alert user to the presence of important operating and maintenance (servicing) instruction in the literature accompanying the appliance.

Specification

Frequency Range	: AM 530 - 1700 KHz
	: FM 88 - 108 MHz
Power Supply	: AC 120V ~ 60Hz
Power Consumption	: 65W
Speed	: 33 1/3, 45, 78 RPM
Speaker	: 3"x 5" 4ohm 5W x 2
Replacement Needle	: NP4

* DESIGN AND SPECIFICATIONS SUBJECT TO CHANGE WITHOUT NOTICE.

CD Operation

CD Recording Operation

Preparation

This unit is designed to record CD-R and CD-RW discs bearing the identification logo "Compact Disc Recordable" or "CD-Rewritable". If CD's do not conform to this standard, they may not record properly.

Recording Records to CD

- 1 Load a compatible blank CD-R or CD-RW into the unit.
- 2 Press the FUNCTION button (2/63) to set the unit to Phono mode.
- 3 Set the SPEED CONTROL SWITCH (32) to the correct speed (33 1/3, 45 or 78 rpm) for the selected record.
- 4 Use the CUE LEVER (30) to raise the tone arm off its rest. Move the tone arm over the record and use the cue lever to lower it to the point you want the recording to start.
- 5 Press the CD RECORD button (7/50). "Record" will show on the LCD. The CD will begin recording.
- 6 Once the first side of the record is finished, press the STOP (12/48) button. The display will read "CLOSE TK" for two seconds and then change to "PHONO".
- 7 Turn the record over and repeat steps 4-6 to record the other side.
- 8 After recording is completed, press the STOP (12/48) button. The display will read "CLOSE TK" for two second and then change to "PHONO".
- 9 Once you have finished the recording, press the FINALIZE (5/54) button. The display will read "Finalize".
- 10 Once the CD has been finalized, the unit will return to Phono mode and the display will show "PHONO". The CD is now ready for use.

NOTE: If the CD is not finalized, it will not play in any other CD player. Not all CD players are compatible with CD-R and CD-RW's. Check the owner's manual for other CD players for compatibility.

Unpacking

- 1 Remove packing materials from unit.
NOTE: Save all packing materials.
- 2 Remove plastic bag covering radio.
- 3 Remove plastic safety cover from A/C plug.
- 4 Remove tie from A/C cord and untie antenna wire on back of radio.
- 5 Open lid and remove styrofoam shipping material from turntable.
- 6 Remove black tie-wrap from under the tone arm.
- 7 Remove tape and white protective needle cover by gently pulling down off the tone arm.

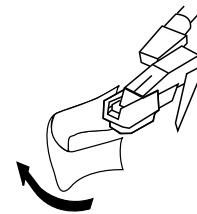

- 8 Turn the TURNTABLE SUSPENSION SCREW (28) clockwise until it is all the way down. Do not force or over tighten it. This allows the turntable to float on its shock absorbers.



- 9 Release tone arm hold down clip by gently pushing to the right. This will unlock tone arm from its arm rest. Re-lock the hold down clip when moving the unit to another location.

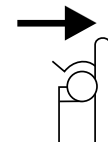

Getting Started

Power Source

- 1 Unwind the AC POWER CORD (37) at the back of the unit and connect it to a power outlet.
- 2 Plug A/C cord into appropriate outlet.

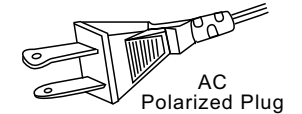

- 3 This product is equipped with a polarized alternating current line plug (a plug having one blade wider than the other). This plug will fit into the power outlet only one way. This is a safety feature. If you are unable to insert the plug fully into the outlet, try reversing the plug. If the plug should still fail to fit, contact your electrician to replace your obsolete outlet. Do not defeat the purpose of the polarized plug.

Headphones Jack Operation

- 1 Connect headphones to the Headphone Jack (13)
- 2 Adjust volume to the desired listening level.

NOTE: When using headphones, the sound to the unit speakers will be cut off.

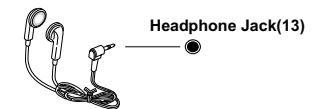

The sound from all speakers is cut off.

NOTE: Headphones not included with unit.

CD Operation

Playing a CD

- 1 Press the FUNCTION button (2/63) to set the unit to CD mode.
- 2 Press the EJECT button (17/41) to open the CD drawer. Insert a CD into the tray with the label side facing up.
- 3 Press the EJECT button (17/41) again to close the CD drawer. The display will show "CD Load" for a few seconds and playback will automatically begin.
- 4 To skip forwards or backwards through the tracks on a CD, press the ►► (11/59) or ◄◄ (8/47) buttons.
- 5 To fast forward or rewind through a track, press and hold the ►► (11) or ◄◄ (8) buttons on the control panel. Release the buttons once you reach the desired position on the track. To use the remote to fast forward or rewind, press the ►► (57) or ◄◄ (45) button one time. Once the desired position is reached, press the button again to resume play.

Repeat Playback

- 1 To repeat a single track, select the desired track number and press the REPEAT button (44) once. Press the PLAY button. "Repeat one" will show on the display and the selected track will repeat once it is finished.
- 2 To repeat a whole CD, press the REPEAT button (44) twice. The display will show "Repeat All". Once the disc is finished, it will start over again from the beginning.
- 3 To turn off the repeat feature, press the REPEAT button (44) again. The repeat display will disappear from the LCD.

Random Play

- 1 While playing a CD, press the RANDOM button (43) on the remote control. "Rand" will show on the LCD display. The unit will randomly select songs from the CD.
- 2 To cancel Random playback, press the RANDOM button (43) again.

Programmed Playback

- 1 Make sure the CD is stopped.
- 2 Press the PROGRAM button (20/42). "01" will show on the display.
- 3 Press the ►► (11/59) or ◄◄ (8/47) buttons to select a desired track.
- 4 Press the PROGRAM button (20/42) twice to store the selected track number.
- 5 Repeat above steps 3 and 4 to program additional tracks into memory.

NOTE: Maximum of 99 tracks can be programmed into memory.

Control Locators

Unit Controls

- 35 Aux In Jack
- 36 Audio Output Jack
- 37 AC Power Cord
- 38 External antenna
- 39 Adapter For 45 rpm Records

Remote Controls

- 40 Power Button
- 41 Eject Button
- 42 Program Button
- 43 Random Button
- 44 Repeat Button
- 45 CD Rewind ◄◄
- 46 FIND Button
- 47 Backward Skip ◄◄
- 48 Stop Button ■
- 49 Folder + Button
- 50 Record Button
- 51 Track Split Button
- 52 Erase Button
- 53 Band Button(AM/FM)
- 54 Finalize Button
- 55 0-9, 10+ Button
- 56 Mute Button
- 57 CD Fast Forward ►►
- 58 Play/CD Pause Button ►||
- 59 Forward Skip ►►
- 60 Folder - Button
- 61 Mono/Stereo Button
- 62 EQ Button
- 63 Function Button
- 64 Volume Down
- 65 Volume Up

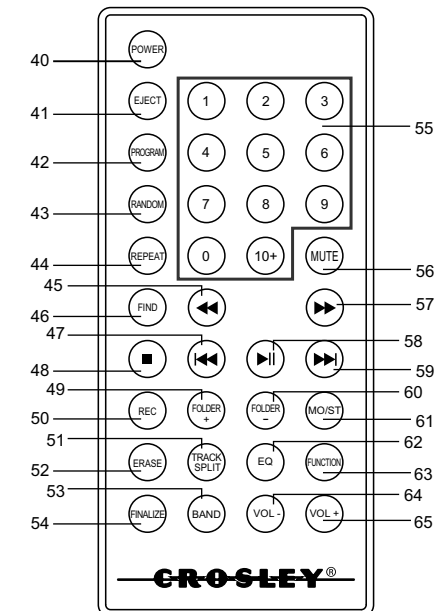
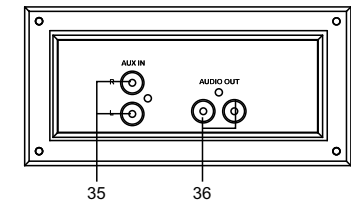
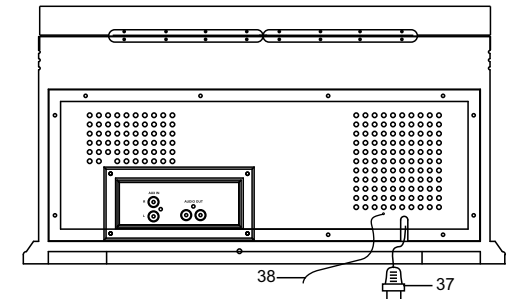

IMPORTANT SAFETY INSTRUCTION

PLEASE READ CAREFULLY ALL THE FOLLOWING IMPORTANT SAFEGUARDS THAT ARE APPLICABLE TO YOUR EQUIPMENT

1. Read Instructions - All the safety and operating instructions should be read before the product is operated.
2. Retain instructions - The safety and operating instructions should be retained for future reference.
3. Heed Warnings - All warnings on the product and in the operating Instructions should be adhered to.
4. Follow Instructions - All operating and use instructions should be followed.
5. Cleaning - Unplug this product from the wall outlet before cleaning. Do not use liquid cleaners or aerosol cleaners. Use a damp cloth for cleaning.
6. Attachments - Do not use attachments not recommended by the product manufacturer as they may cause hazards.
7. Water and Moisture - Do not use this product near water - for example, near a bath tub, wash bowl, kitchen sink, or laundry tub; in a wet basement; or near a swimming pool; and the like.
8. A product and cart combination should be moved with care. Quick stops, excessive force, and uneven surfaces may cause the product and cart combination to overturn.
9. Ventilation - Slots and openings in the cabinet are provided for ventilation and to ensure reliable operation of the product and to protect it from overheating, and these openings must not be blocked or covered. The openings should never be blocked by placing the product on a bed, sofa, rug, or other similar surface. This product should not be placed in a built-in installation such as a bookcase or rack unless proper ventilation is provided or the manufacturer's instructions have been adhered to.
10. Power Sources - This product should be operated only from the type of power source indicated on the marking label, if you are not sure of the type of power supply to your home. Consult your product dealer or local power company. For products intended to operate from battery power, or other sources, refer to the operating instructions.
11. Grounding or Polarization - This product may be equipped with a polarized alternating-current line plug (a plug having one blade wider than the other). This plug will fit into the power outlet only one way. This is a safety feature. If you are unable to insert the plug fully into the outlet try reversing the plug. If the plug should still fail to fit, contact your electrician to replace your obsolete outlet. Do not defeat the safety purpose of the polarized plug.
12. Power - Cord Protection - Power - supply cords should be routed so that they are not likely to be walked on or pinched by items placed upon or against them, paying particular attention to cords at plugs, convenience receptacles, and the point where they exit from the product.
13. Lightning - For added protection for this product during a lightning storm, or when it is left unattended and unused for long periods of time, unplug it from the wall outlet and disconnect the antenna or cable system. This will prevent damage to the product due to lightning and power - line surges.
14. Power Lines - An outside antenna system should not be located in the vicinity of overhead power lines or other electric light or power circuits, or where it can fall into such power lines or circuits. When installing an outside antenna system, extreme care should be taken to keep from touching such power lines or circuits as contact with them might be fatal.
15. Overloading - Do not overload wall outlets, extension cords, or integral convenience receptacles as this can result in a risk of fire or electric shock.
16. Object and Liquid Entry - Never push objects of any kind into this product through openings as they may touch dangerous voltage points or short - out parts that could result in a fire or electric shock. Never spill liquid of any kind on the product.
17. Servicing - Do not attempt to service this product yourself as opening or removing covers may expose you to dangerous voltage or other hazards. Refer all servicing to qualified service personnel.
18. Damage Requiring Service - Unplug this product from the wall outlet and refer servicing to qualified service personnel under the following conditions:
 - a. When the power-supply cord or plug is damaged.
 - b. If liquid has been spilled, or objects have fallen into the product.
 - c. If the product has been exposed to rain or water.
 - d. If the product does not operate normally by following the operating instructions. Adjust only those controls that are covered by the operating instructions as an improper adjustment of other controls may result in damage and will often require extensive work by a qualified technician to restore the product to its normal operation.
 - e. If the product has been dropped or damaged in any way.
 - f. When the product exhibits a distinct change in performance - this indicates a need for service.
19. Replacement Parts - When replacement parts are required, be sure the service technician has used replacement parts specified by the manufacturer or have the same characteristics as the original part. Unauthorized substitutions may result in fire, electric shock, or other hazards.
20. Safety Check - Upon completion of any service or repairs to this product, ask the service technician to perform safety checks to determine that the product is in proper operating condition.
21. Wall or ceiling Mounting - The product should be mounted to a wall or ceiling only as recommended by the manufacturer.
22. Heat - The product should be situated away from heat sources such as radiators. Heat registers, stoves, or other products (including amplifiers) that produce heat.

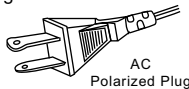

WARNING: Changes or modifications to this unit not expressly approved by the party responsible for compliance could void the user's authority to operate the equipment.

NOTE: This equipment has been tested and found to comply with the limits for a Class B digital device, pursuant to Part 15 of the FCC Rules. These limits are designed to provide reasonable protection against harmful interference in a residential installation. This equipment generates, uses, and can radiate radio frequency energy and, if not installed and used in accordance with the instructions, may cause harmful interference to radio communications. However, there is no guarantee that interference will not occur in a particular installation. If this equipment does cause harmful interference to radio or television reception, which can be determined by turning the equipment off and on, the user is encouraged to try to correct the interference by one or more of the following measures:

- Reorient or relocate the receiving antenna.
- Increase the separation between the equipment and receiver.
- Connect the equipment into an circuit different from that to which the receiver is connected.
- Consult the dealer or an experienced radio TV technician for help.

Troubleshooting

There is no Power

- 1 Make sure the radio is plugged in correctly.
- 2 Check to see that the power button is pushed in.

There is no Sound

- 1 Check the volume level by turning the volume knob.

Turntable will not work

- 1 Make sure the unit is set to Phono mode by pressing the Function button.
- 2 Make sure the protective needle cover is removed.
- 3 Make sure the chrome Turntable Suspension Screw is screwed all the way down.

CD does not play

- 1 Check to make sure CD is inserted correctly (label side facing up).
- 2 Check that the surface of the CD is clean
- 3 Make sure function switch is set to CD.
- 4 Make sure the CD is not blank.

Welcome

Thank you for purchasing the Crosley Director CD Recorder (CR245). Before operating this unit, please read this manual thoroughly and retain it for future reference.

About This Manual

Instructions in this manual describe the control functions of the CR245.

Included in the package:

- Director CD Recorder
- Remote Control
- 45 RPM adaptor

Table of Contents

Getting Started

Unpacking.....	4
Power Source.....	4
Control Locators.....	5-6

Basic Operation

General.....	7
Radio Operation.....	7
Turntable Operation.....	8

CD Operation

Playing a CD.....	9
Programmed Playback.....	9
Playing MP3 CD's.....	10
Recording records to CD.....	11
Erasing CD-RW CD's.....	12

Audio / Connections

Audio.....	13
------------	----

General

Troubleshooting Guide.....	14
Warranty.....	15

CD Operation

Manual Track Division

You can divide your recording into separate tracks if you wish. By doing this, each song will have its own sequential track number. To do this, you must use the Split Track button (6/51).

While Recording your record, listen for the end of each song. There will usually be a brief silence between songs. Once you are at the end of the song, press the Split Track button. The recording will then go to the next track number by increments of one. Once the recording is finished, you can press the ►► (11/59) or the ◀◀ (8/47) buttons to go to the beginning of each song.

Erasing a CD-RW

If using a CD-RW, you can erase the whole CD and rerecord it. Erase procedures are only possible with CD-RW discs. It is not possible to erase or rerecord a CD-R CD. To erase a CD-RW, follow the steps below.

- 1 Press the FUNCTION button (2/63) to set the unit to CD mode.
- 2 Load a recorded CD-RW into the unit.
- 3 Press the STOP button (12/48) to stop playback.
- 4 Press the ERASE button (3/52). ERASE / Y will appear on the display, Press PLAY Button(14/58) to confirm and the erasing process will begin, if cancel please press the STOP Button(12/48). When finished, the display will first read "F Done" and then "BLANK CD".
- 5 The CD is now ready to record.

NOTE: Once a CD is erased, the contents that were on the CD cannot be retrieved.

Control Locators

Unit Controls

- 1 Speakers
- 2 Function Button (CD/PHONO/RADIO/AUX)
- 3 Erase Button
- 4 Band Button(AM/FM)
- 5 Finalize Button
- 6 Track Split Button
- 7 Record Button
- 8 Backward Skip ◀◀
- 9 Line In Jack
- 10 CD Drawer
- 11 Forward Skip ▶▶
- 12 Stop Button ■
- 13 Headphone Jack
- 14 Play/Pause ▶||
- 15 Power Button
- 16 FIND Button
- 17 Eject Button
- 18 Folder - Button
- 19 Folder + Button
- 20 Program Button
- 21 Tuning Knob
- 22 Dial Scale
- 23 LCD Display
- 24 Stand By Indicator
- 25 Stereo Indicator
- 26 Sensor
- 27 Volume Knob
- 28 Turntable Suspension Screw
- 29 Hold Down Clip
- 30 Cue Lever
- 31 Tone Arm Rest
- 32 Speed Control Switch
- 33 Tone Arm
- 34 Turntable

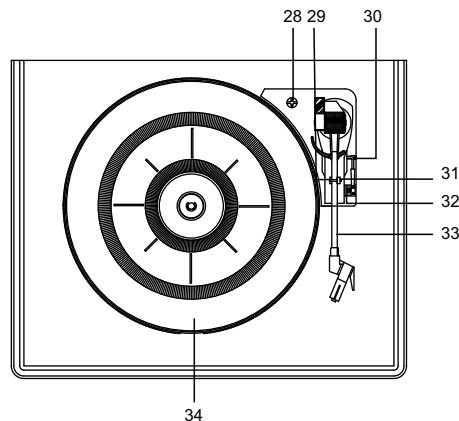
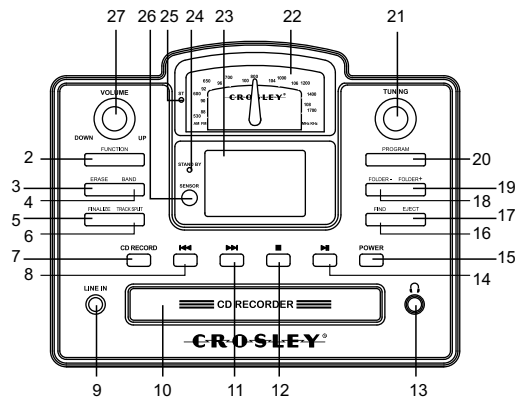
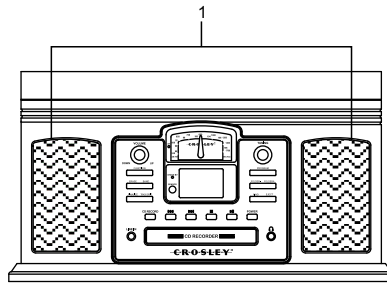

CD Operation

Playing MP3 CD's

This unit will play CD's recorded in MP3 format. All the controls and functions work the same as a regular CD. Listed below are features and instructions that are unique to playing a MP3 CD.

Folder/Album Playback

If your MP3 CD is separated into folders, follow the steps below to access the folders.

- 1 While the CD is stopped, press the FOLDER+ (19/49) or the FOLDER- (18/60) buttons to advance forward or backwards through the folders on your disc.
- 2 Once the desired folder is reached, use the FORWARD SKIP(11/59) or the BACKWARD SKIP(8/47) buttons to select the desired track.
- 3 Press the PLAY (14/58) to begin playback of the selected track.

CD Information

If the MP3 CD has track information stored on it, such as artist and title, the LCD will display that information during playback of the CD.

- 1 While the MP3 disc is playing, press the BAND (4/53) button.
- 2 The CD information will start to scroll across the LCD.
- 3 Press the BAND (4/53) button again to cancel the information.

NOTE: If the CD was recorded without any track information, UNKNOWN will be displayed when the BAND button is pressed.

Search Play

MP3 CD's normally contain many files. By using the search features described below, you can easily and quickly locate albums or songs. Follow the steps below to use the search feature.
Search by File Name

Search by File Name

- 1 In stop or play mode, press the FIND (16/46) to start the alphabetic and numerical search.
- 2 Press the FOLDER+(19/49) or the FOLDER-(18/60) buttons to select the corresponding letter or number of the track you are searching for.
- 3 When the desired track is found, press the PLAY (14/58) button to start playing the selected track.
- 4 To exit search mode press the FIND button until the "P" disappears from the LCD display.

Search by Folder / Album Title

- 1 While the CD is stopped, press the FIND (16/46) button twice to start to browse the album. The search icon, ALBUM 001 and its name will be shown on the display.
- 2 Press the FOLDER+ (19/49) or FOLDER- (18/60) button repeatedly to select the desired album.
- 3 Press the FORWARD SKIP(11/59) or the BACKWARD SKIP(8/47) buttons to select the desired folder/album.

NOTE: The search feature will only work if the MP3 CD has information such as Folder, Artist and Song titles already stored on the CD. This information is added at the time the CD is created and cannot be added afterwards.

NOTE: You cannot record MP3 CD's with this unit. They must be created with a computer or other device.

Basic Operation

General

- 1 Make sure the unit is plugged in correctly to an AC outlet.
- 2 Press the POWER button (15/40) to turn on the unit .
- 3 Once the power is turned on, press the FUNCTION button (2/63) to switch between CD/Tuner/Phono/Aux. When switching between functions, wait one second after pressing the function button before pressing it again. This gives the unit time to load the correct information for the selected function.

Radio Operation

- 1 Press the FUNCTION button (2/63) to set the unit to Tuner mode
- 2 Press the BAND button (4/53) to select the desired tuning band (AM/FM).
- 3 Select the desired radio station by rotating TUNING KNOB (21).
- 4 Adjust the volume to the desired listening level.

Antenna

Antenna: for FM reception, the unit is provided with a FM WIRE ANTENNA (38) , move the wire until the reception is clear and with no interferences. For AM reception, the unit is provided with a directional build-in ferrite antenna. Rotate the set to find the position in which the best reception is obtained. Do not connect the EXTERNAL FM ANTENNA (38) to any outside antenna.

Basic Operation

Turntable Operation

- 1 Press the FUNCTION button (2/63) to set the unit to Phono mode.
- 2 Set the SPEED CONTROL SWITCH (32) to the correct speed (33 1/3, 45 or 78 rpm) for the selected record.
- 3 Use the CUE LEVER (30) to raise the tone arm off its rest. Move the tone arm over the record and use the cue lever to lower it to the point you want the record to start.
- 4 At the end of the record, the tone arm will return to its rest.

Accessory: ADAPTER FOR 45 RPM

To play the 45rpm record, place the ADAPTER (39) on the spindle.

