

Panasonic[®]

Operating Instructions

Multi-format Live Switcher

Model No. **AV-HS450N**

Mainframe
[AV-HS450U1N]

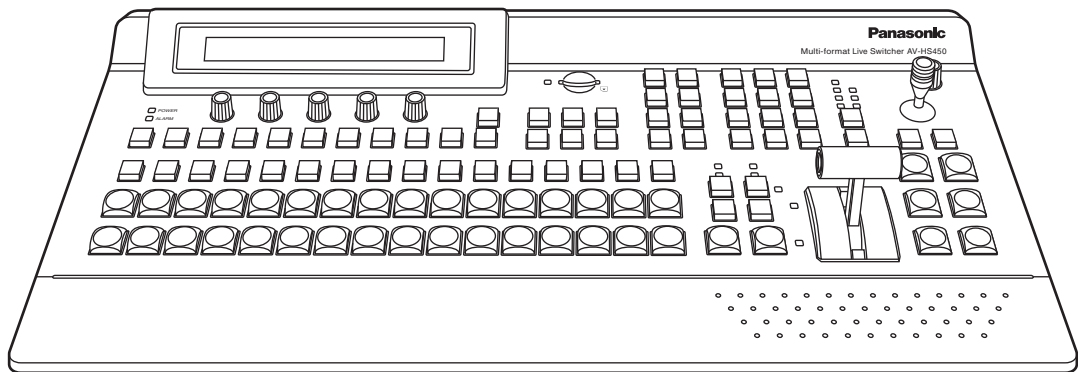
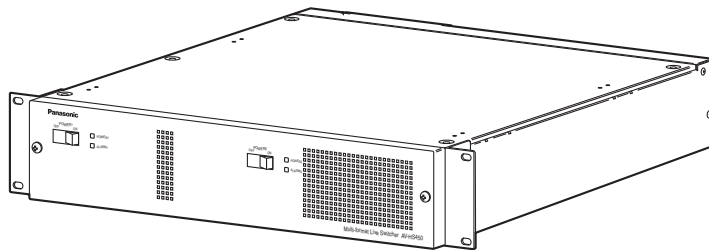



Control panel [AV-HS450C1N]



Before operating this product, please read the instructions carefully and save this manual for future use.

Safety precautions

	CAUTION RISK OF ELECTRIC SHOCK DO NOT OPEN	
CAUTION: TO REDUCE THE RISK OF ELECTRIC SHOCK, DO NOT REMOVE COVER (OR BACK). NO USER SERVICEABLE PARTS INSIDE. REFER TO SERVICING TO QUALIFIED SERVICE PERSONNEL.		



The lightning flash with arrowhead symbol, within an equilateral triangle, is intended to alert the user to the presence of uninsulated "dangerous voltage" within the product's enclosure that may be of sufficient magnitude to constitute a risk of electric shock to persons.



The exclamation point within an equilateral triangle is intended to alert the user to the presence of important operating and maintenance (service) instructions in the literature accompanying the appliance.

WARNING:

■ THIS APPARATUS MUST BE EARTHED

To ensure safe operation, the three-pin plug must be inserted only into a standard three-pin power point which is effectively earthed through the normal household wiring.

Extension cords used with the apparatus must have three cores and be correctly wired to provide connection to the earth. Wrongly wired extension cords are a major cause of fatalities.

The fact that the apparatus operates satisfactorily does not imply that the power point is earthed or that the installation is completely safe. For your safety, if you are in any doubt about the effective earthing of the power point, please consult a qualified electrician.

For CANADA

This class A digital apparatus complies with Canadian ICES-003.

Cet appareil numérique de la classe A est conforme à la norme NMB-003 du Canada.

WARNING:

- TO REDUCE THE RISK OF FIRE OR ELECTRIC SHOCK, DO NOT EXPOSE THIS APPARATUS TO RAIN OR MOISTURE.
- THE APPARATUS SHALL NOT BE EXPOSED TO DRIPPING OR SPLASHING AND THAT NO OBJECTS FILLED WITH LIQUIDS, SUCH AS VASES, SHALL BE PLACED ON THE APPARATUS.

CAUTION:
TO REDUCE THE RISK OF FIRE OR SHOCK HAZARD AND ANNOYING INTERFERENCE, USE THE RECOMMENDED ACCESSORIES ONLY.

FCC Note:
This equipment has been tested and found to comply with the limits for a class A digital device, pursuant to Part 15 of the FCC Rules. These limits are designed to provide reasonable protection against harmful interference when the equipment is operated in a commercial environment. This equipment generates, uses, and can radiate radio frequency energy, and if not installed and used in accordance with the instruction manual, may cause harmful interference to radio communications. Operation of this equipment in a residential area is likely to cause harmful interference in which case the user will be required to correct the interference at his own expense.

Warning:
To assure continued FCC emission limit compliance, the user must use only shielded interface cables when connecting to external units. Also, any unauthorized changes or modifications to this equipment could void the user's authority to operate it.

CAUTION:
In order to maintain adequate ventilation, do not install or place this unit in a bookcase, built-in cabinet or any other confined space. To prevent risk of electric shock or fire hazard due to overheating, ensure that curtains and any other materials do not obstruct the ventilation.

The socket outlet shall be installed near the equipment and easily accessible or the mains plug or a power switch shall remain readily operable.

A warning that an apparatus with CLASS I construction shall be connected to a MAINS socket outlet with a protective earthing connection.

 indicates safety information.

Safety precautions

IMPORTANT SAFETY INSTRUCTIONS

Read these operating instructions carefully before using the unit. Follow the safety instructions on the unit and the applicable safety instructions listed below. Keep these operating instructions handy for future reference.

- 1) Read these instructions.
- 2) Keep these instructions.
- 3) Heed all warnings.
- 4) Follow all instructions.
- 5) Do not use this apparatus near water.
- 6) Clean only with dry cloth.
- 7) Do not block any ventilation openings. Install in accordance with the manufacturer's instructions.
- 8) Do not install near any heat sources such as radiators, heat registers, stoves, or other apparatus (including amplifiers) that produce heat.
- 9) Do not defeat the safety purpose of the polarized or grounding-type plug. A polarized plug has two blades with one wider than the other. A grounding-type plug has two blades and a third grounding prong. The wide blade or the third prong are provided for your safety. If the provided plug does not fit into your outlet, consult an electrician for replacement of the obsolete outlet.
- 10) Protect the power cord from being walked on or pinched particularly at plugs, convenience receptacles, and the point where they exit from the apparatus.
- 11) Only use attachments/accessories specified by the manufacturer.
- 12) Use only with the cart, stand, tripod, bracket, or table specified by the manufacturer, or sold with the apparatus. When a cart is used, use caution when moving the cart/apparatus combination to avoid injury from tip-over. 
- 13) Unplug this apparatus during lightning storms or when unused for long periods of time.
- 14) Refer all servicing to qualified service personnel. Servicing is required when the apparatus has been damaged in any way, such as power-supply cord or plug is damaged, liquid has been spilled or objects have fallen into the apparatus, the apparatus has been exposed to rain or moisture, does not operate normally, or has been dropped.

 indicates safety information.

<For USA-California Only>

This product contains a CR Coin Cell Lithium Battery which contains Perchlorate Material – special handling may apply.

See www.dtsc.ca.gov/hazardouswaste.perchlorate.

Contents

Description.....	7	3. Basic operations.....	33
Features.....	7	3-1. Background transition.....	33
Configuration	9	3-1-1. Selecting the bus	33
Accessories	9	3-1-2. Selecting the bus using the SHIFT function	33
Precautions for use	10	3-1-3. Selecting the bus mode	36
Trademarks and Registered Trademarks	11	3-1-4. Selecting the transition mode	37
Disclaimer of Warranty	11	3-1-5. Manual transition (using the fader lever)...	37
1. Installation.....	12	3-1-6. Auto transition.....	37
1-1. Installing the control panel.....	12	3-1-7. Cut transition.....	37
1-2. Installing the mainframe	13	3-2. IMAGE.....	38
1-3. How to install the option boards	14	3-2-1. Setting the IMAGE effects.....	38
1-4. Connections	16	3-2-2. Executing the IMAGE effect.....	39
1-4-1. Block diagram	16	3-3. Wipe	40
1-4-2. Connections when implementing gen-lock (frame synchronizer OFF)	17	3-3-1. Selecting the wipe pattern	40
1-4-3. Connections when not implementing gen- lock (frame synchronizer ON)	18	3-3-2. Selecting the background for the 3D2 pattern page	42
2. Functions in each area.....	19	3-3-3. Selecting the wipe direction.....	42
2-1. Control panel.....	19	3-3-4. Wipe decorations (border, soft effect)	43
2-1-1. Crosspoint area	20	3-3-5. Setting the wipe start position.....	44
2-1-2. Wipe pattern/memory area	21	3-3-6. Modifying wipe	45
2-1-3. User button area	22	3-4. Key	47
2-1-4. Transition area	22	3-4-1. Selecting the key type.....	48
2-1-5. LCD menu area	25	3-4-2. Selecting the key material.....	49
2-1-6. Positioner area.....	27	3-4-3. Key transitions	50
2-1-7. SD memory card area	28	3-4-4. Key preview.....	51
2-1-8. Rear panel connections area.....	29	3-4-5. Adjusting the luminance key and linear key	52
2-2. Mainframe	30	3-4-6. Adjusting the chroma key	53
2-2-1. Front panel.....	30	3-4-7. Key decorations	61
2-2-2. Rear panel connections area.....	31	3-4-8. Masking the key signals.....	62
		3-4-9. Flying key.....	63
		3-5. PinP (picture in picture).....	64
		3-5-1. Selecting the PinP channel and material	64
		3-5-2. Selecting Shape.....	65
		3-5-3. PinP preview	65
		3-5-4. PinP transitions.....	66
		3-5-5. PinP adjustments.....	66
		3-5-6. Linking PinP1 and PinP2	68
		3-5-7. PinP decorations.....	69
		3-5-8. Trimming settings.....	70

Contents

3-6. DSK (downstream key).....	71	4. Input/output signal settings.....	96
3-6-1. Selecting the DSK type.....	71	4-1. Input signal settings.....	96
3-6-2. Selecting the DSK channel and DSK fill material.....	73	4-1-1. Setting the frame synchronizer	97
3-6-3. DSK transitions	74	4-1-2. Setting the input mode.....	98
3-6-4. DSK preview	74	4-1-3. Freezing the input signals.....	99
3-6-5. DSK adjustments.....	75	4-1-4. Color corrector.....	100
3-6-6. DSK decorations.....	76	4-1-5. Setting the up-converter	104
3-6-7. Masking the DSK signals.....	77	4-1-6. Setting the analog input gain (option)	105
3-7. FTB (fade to black).....	78	4-1-7. Setting the analog composite input signals (option).....	106
3-8. Internal color signals	79	4-2. Setting the DVI input signals (option)	107
3-8-1. Setting the color background.....	79	4-2-1. Setting the DVI input signals.....	107
3-9. Switching the AUX output.....	80	4-2-2. Adjusting the DVI input signals	111
3-9-1. Selecting the AUX output materials	80	4-3. Setting the output signals.....	112
3-9-2. AUX1 transitions	81	4-3-1. Assigning the output signals.....	113
3-9-3. Setting enable/disable for the AUX1 transition.....	82	4-4. Setting the DVI output signals (OUT5 and OUT6 standard outputs and options).....	115
3-10. Memory	83	4-5. Setting the down-converter (option)	117
3-10-1. Memory registration and recall items.....	84	4-6. Setting the sync signals.....	118
3-10-2. Storing the settings in the memory (Store)	85	4-7. Adjusting the output signal phase	119
3-10-3. Recalling the operations stored in the memory (Recall).....	86	4-8. Setting the multi view display	123
3-10-4. Deleting the operations stored in the memory (Delete)	87	4-8-1. Setting the screen layout	123
3-10-5. Effect dissolve.....	88	4-8-2. Setting the split frame and characters	125
3-11. Frame memories	89	4-8-3. Setting the tally displays	126
3-11-1. Transferring images from the AUX bus ...	89	4-8-4. Changing the material names.....	127
3-11-2. Saving Images in Flash Memory	90	4-8-5. High-resolution multi view mode.....	128
3-12. SD memory cards	91	4-9. Setting the on-screen display (OSD).....	129
3-12-1. Initializing the SD memory cards	92	4-10. Setting the ancillary data.....	130
3-12-2. Saving data on SD memory cards.....	93		
3-12-3. Loading data from SD memory cards.....	94		
3-12-4. Deleting files on SD memory cards	95		
3-12-5. Displaying the SD memory card information.....	95		

Contents

5. System settings	131	6. External interfaces	154
5-1. Selecting the video format.....	131	6-1. Connecting the control panel and mainframe.....	154
5-2. Setting the crosspoints.....	132	6-2. Mainframe	154
5-2-1. Assigning signals to the crosspoints.....	132	6-2-1. LAN.....	154
5-2-2. Setting the crosspoint switching	134	6-2-2. EDITOR	155
5-3. Button assignments.....	135	6-2-3. COM	155
5-3-1. Setting the user buttons.....	135	6-2-4. TALLY/GPI.....	156
5-4. Setting the date and time	137	6-3. Control panel.....	157
5-5. Network settings.....	138	6-3-1. TALLY/GPI.....	157
5-6. Other settings.....	139	7. Image transmission functions.....	158
5-7. External device control.....	140	8. Setting menu table.....	163
5-7-1. Enable/Disable Setting for Control of External Devices	140	9. Appearance	181
5-7-2. Editor control.....	141	10. Specifications	182
5-7-3. Setting the GPI	142	Appendix (glossary).....	187
5-7-4. Camera control	144		
5-8. Status displays	151		
5-8-1. Alarm status displays.....	151		
5-8-2. Alarm message.....	151		
5-8-3. Displaying the version information and option information.....	152		
5-9. Initialization.....	153		
5-9-1. Initializing Setting Data	153		
5-9-2. Initializing Fader.....	153		

Description

This is a 1 ME digital video switcher which supports a multiple number of HD and SD formats.

It consists of a mainframe and control panel.

Despite its compact dimensions of 2RU, the mainframe comes with 16 inputs and four outputs for SDI under the standard specifications.

It also supports two DVI outputs, and its video effects of one key line, two DSK lines, two PinP lines, two DVE (BKGD) lines, one DVE (key) line and two multi view lines enable video productions in a wide variety of forms.

Incorporated in the switcher's inputs are a frame synchronizer, up-converter and color corrector.

When the option boards are installed, a wider variety of input/output formats including analog composite, analog component and DVI can be accommodated so that systems can be constructed flexibly.

Features

Compact design, wide variety of input/output signals

- The mainframe, despite its compact dimensions of 2RU, comes with a wide variety of input/output facilities in the standard configuration.

As input facilities, a total of 16 HD/SD-SDI signal lines are supported under the standard specifications, and a frame synchronizer is incorporated for all the inputs. Also incorporated are four up-converter signal lines and eight color corrector signal lines.

The output facilities include four HD/SD-SDI signal lines and two DVI-D signal lines under the standard specifications.

- Two option slots each for input/output applications are provided.

When two option boards for input applications are installed, the maximum number of input signal lines can be expanded to 20; similarly, when two option boards for output applications are installed, the maximum number of output signal lines can be increased to 10.

Multiple formats supported

- The signal formats supported include HD formats (1080/59.94i, 1080/50i, 1080/24PsF #1, 1080/23.98PsF #1, 720/59.94p and 720/50p), SD formats (480/59.94i and 576/50i) and DVI #2.

*1: The following option boards are not supported:

AV-HS04M1, AV-HS04M2, AV-HS04M3, AV-HS04M4, AV-HS04M5, AV-HS04M6, AV-HS04M7

*2: The standard DVI output is the DVI-D signal output.

The AV-HS04M3 option board supports DVI-I signal input, the AV-HS04M8 option board supports DVI-D signal input, and the AV-HS04M5 supports DVI-I signal output.

Multi view display function

- Two multi view display function lines are provided under the standard specifications.

It is possible to divide up to 20 lines of video including program video (PGM), preview video (PVW) and input video signals between two screens and display them at the same time on two monitors.

Frame synchronizer system and external synchronization system supported

- A high-performance 10-bit frame synchronizer is incorporated for all the inputs so that asynchronous video signals can be input. By using the black burst (BB) output, it is possible to construct a system referenced to the synchronization of the switcher.
- A genlock function is provided so that external synchronization systems using external sync signals (BB or TRI signals) as a reference are also supported.

Features

Many different effect functions incorporated

- Along with the standard wipe, mix and cut functions, the switcher can provide size reduction, slide and other DVE transitions.
- DVE transitions using the 2-screen push-out effect and other 2-channel functions are possible.
- The unit comes with luminance keys and chroma keys provided as keyers as well as specialized hardware in the form of two DSK lines and two PinP lines as a standard option.
- AUX1 is equipped with a mix transition function.
This enables MIX transitions with the material selected next, allowing for a flexible system construction.

High-quality chroma keys using Primatte® algorithms

The Primatte® algorithm, which has proven to be very popular in many non-linear editors as a plug-in software, has been put to practical use in a linear editing system for the chroma keys. High chroma key image quality can be achieved through some simple operations.

- Primatte® is a registered trademark of IMAGICA DIGIX Inc.
- The copyrights of Primatte® belong to IMAGICA DIGIX Inc.
- The patents for Primatte® belong to IMAGICA DIGIX Inc.

SDHC memory cards supported

- Still image data (BMP, JPEG) can be imported from SDHC memory cards into the unit's frame memories for use as background images or key materials.

In addition, the images and setting data in the unit's frame memories can be stored on the SDHC memory cards.

- SDHC Logo is a trademark.

Pan-tilt head system (pan-tilt head and convertible camera) control supported

- Using the COM connector, a Panasonic pan-tilt head system (with pan, tilt, zoom, focus and preset functions) can be controlled.

When a controller is used, up to five pan-tilt head systems can be controlled.

Camera menu operations can also be performed.

Controllers supported	AW-RP555N, AW-RP655N
Pan-tilt heads supported	AW-PH400P, AW-PH405N, AW-PH360N
Camera supported	AW-HE100N

Redundant power supply

- Under the standard specifications, a redundant power supply is provided so that live operations can be undertaken with complete peace of mind.

Simple operability

- Live transmissions can be delivered speedily thanks to the 16 crosspoint buttons and pattern selection buttons and other controls on the panel with its simple layout that enables various functions to be operated directly. Preset-like operations are performed using menus appearing on the unit's LCD display or on the on-screen displays.

Configuration

Mainframe [AV-HS450U1N]	1
Control panel [AV-HS450C1N]	1

Accessories

Operating instructions	1
CD-ROM (Operating instructions/Image transmission software)	1
AC adapters (for control panel)	2
Power cords (for mainframe and AC adapter)	4
CAT5E cable (STP, straight cable, 10 m long)	1

■ Optional boards (sold separately)

Board	Model number	Function
SDI Input Board	AV-HS04M1	SDI input ×2 lines
Analog Input Board	AV-HS04M2	Analog component input ×2 lines
DVI Input Board	AV-HS04M3	DVI-I input ×2 lines
Analog Output Board	AV-HS04M4	Analog component output ×2 lines
DVI/Analog Output Board	AV-HS04M5	DVI-I output ×1 line Analog component output ×1 line
Analog Composite Input Board	AV-HS04M6	Analog composite input ×2 lines
SDI Output Board	AV-HS04M7	SDI output ×2 lines
Full-HD DVI Input Board	AV-HS04M8	DVI-D input ×2 line

- Option boards are installed in the two input/output option slots (slot A, slot B).

Precautions for use

● Handle carefully.

Do not drop the product, or subject it to strong shock or vibration.

Do not carry or move the product by the fader lever. This is important to prevent trouble.

● Use the product in an ambient temperature of 32 °F to 104 °F (0 °C to 40 °C).

Avoid using the product at a cold place below 32 °F (0 °C) or at a hot place above 104 °F (40 °C) because extremely low or high temperature will adversely affect the parts inside.

● Power off before connecting or disconnecting cables.

Before plugging or unplugging the cables, be sure to switch power off.

● Avoid humidity and dust.

Avoid using the product at a humid, dusty place because much humidity and dust will cause damage to the parts inside.

● Maintenance

Wipe the product using a dry cloth. To remove stubborn dirt, dip a cloth into a diluted solution of kitchen detergent (neutral), wring it out well, and wipe the product gently. Then, after wiping the product with a moist cloth, wipe it again with a dry cloth.

Caution

- Avoid using benzene, paint thinners and other volatile fluids.
- If a chemical cleaning cloth is to be used, carefully read through the precautions for its use.

● Precaution to be observed during production

This product's image switching and image effect functions can be used to produce images which flicker rapidly or images which change rapidly.

However, bear in mind when using these functions in production that the kinds of images produced may have an adverse effect on the viewer's physical well-being.

● Handling the optional boards

Be absolutely sure to turn off the power of the product before installing or removing any of the optional boards. Furthermore, when installing or removing the optional boards, take care not to hurt yourself on the edges and metal parts of the boards.

● When the product is to be discarded

When the product is to be discarded at the end of its service life, ask a specialized contractor to dispose of it properly in order to protect the environment.

● Concerning the consumable parts

Cooling fan:

This is a consumable part. As a general rule, replace it every 5 years or so (when the unit has been operated for 15 hours a day).

Power supply unit:

This is a consumable part. As a general rule, replace it every 5 years or so (when the unit has been operated for 15 hours a day).

The period when the consumable parts need to be replaced will differ depending on the operating conditions.

When the time comes to replace one of these parts, be absolutely sure to ask your dealer to do the job.

Precautions for use

Trademarks and Registered Trademarks

- Microsoft and Windows are either registered trademarks or trademarks of Microsoft Corporation in the United States and other countries.
- Adobe and Reader are either registered trademarks or trademarks of Adobe Systems Incorporated in the United States and/or other countries.
- SDHC logo is a trademark.
- Other names of companies and products contained in these operating instructions may be trademarks or registered trademarks of their respective owners.

Disclaimer of Warranty

IN NO EVENT SHALL Panasonic Corporation BE LIABLE TO ANY PARTY OR ANY PERSON, EXCEPT FOR REPLACEMENT OR REASONABLE MAINTENANCE OF THE PRODUCT, FOR THE CASES, INCLUDING BUT NOT LIMITED TO BELOW:

- ① ANY DAMAGE AND LOSS, INCLUDING WITHOUT LIMITATION, DIRECT OR INDIRECT, SPECIAL, CONSEQUENTIAL OR EXEMPLARY, ARISING OUT OF OR RELATING TO THE PRODUCT;
- ② PERSONAL INJURY OR ANY DAMAGE CAUSED BY INAPPROPRIATE USE OR NEGLIGENT OPERATION OF THE USER;
- ③ UNAUTHORIZED DISASSEMBLE, REPAIR OR MODIFICATION OF THE PRODUCT BY THE USER;
- ④ INCONVENIENCE OR ANY LOSS ARISING WHEN IMAGES ARE NOT DISPLAYED, DUE TO ANY REASON OR CAUSE INCLUDING ANY FAILURE OR PROBLEM OF THE PRODUCT;
- ⑤ ANY PROBLEM, CONSEQUENTIAL INCONVENIENCE, OR LOSS OR DAMAGE, ARISING OUT OF THE SYSTEM COMBINED BY THE DEVICES OF THIRD PARTY;
- ⑥ INCONVENIENCE, DAMAGE, OR LOSS RESULTING FROM ACCIDENTS CAUSED BY AN INADEQUATE INSTALLATION METHOD OR ANYTHING OTHER THAN A DEFECT IN THE PRODUCT;
- ⑦ LOSS OF REGISTERED DATA CAUSED BY ANY FAILURE.
- ⑧ ANY DAMAGE OR CLAIMS DUE TO LOSS OR LEAKAGE OF IMAGE DATA OR SETTING DATA SAVED ON THIS UNIT OR ON AN SD CARD OR PC.

1. Installation

1-1. Installing the control panel

Follow the instructions set forth in “Safety precautions” and also observe the cautionary items below.

Be absolutely sure to ask your dealer to do the jobs of installing and connecting the panel.

Connecting the power supply

- Be absolutely sure to use only the power cord and AC adapter supplied with the panel.
- Be absolutely sure to connect the grounding terminal of the power cord to ground.
Also connect the ground terminal (SIGNAL GND) at the rear of the panel to the system ground.
- If only one AC adapter is to be connected, place the dust-proof cap over the DC power input socket that is not going to be used.
- To prevent the DC plug from being disconnected, secure the cable of the AC adapter to the cable clamp.
- When the control panel is not going to be used for a prolonged period of time, set its power switch to the “off” position to conserve power, and disconnect the power plug.

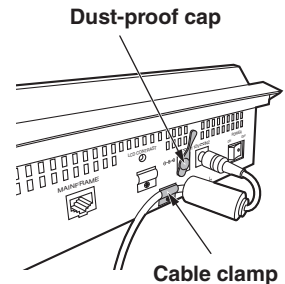

Handle the control panel carefully!

- Dropping the control panel or subjecting it to strong impact or vibration may cause trouble and/or malfunctioning.

Do not allow any foreign objects to enter inside the control panel!

- Allowing water, metal items, scraps of food or other foreign objects inside the control panel may cause a fire and/or electric shocks.

Choosing the best installation location

- This unit is designed for indoor use only.
- Install the unit on a sufficiently strong, stable and level surface for use.
- Ensure a space of at least 100 mm around the rear vents to avoid obstructing ventilation.
In particular, ensure sufficient space between ventilation and wiring when using mounted in a panel or table.
- Do not install the panel in a cold place where the temperatures will drop below 32 °F (0 °C) or in a hot place where the temperatures will rise above 104 °F (40 °C).
- Avoid installing the panel where it will be exposed to direct sunlight or to the hot air that is blown out from other products.
- Installing the panel in a very humid, dusty or vibration-prone location may give rise to trouble.

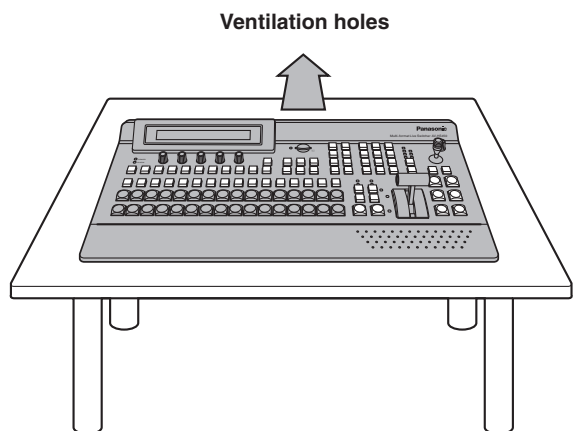

1. Installation

1-2. Installing the mainframe

Comply with the instructions set forth in “Safety precautions” and also observe the cautionary items below.

Be absolutely sure to ask your dealer to do the jobs of installing and connecting the mainframe.

Connecting the power supply

- Be absolutely sure to use the power cord supplied with the mainframe.
- Be absolutely sure to connect the grounding terminal of the power cord to ground.

Handle the mainframe carefully!

- Dropping the mainframe or subjecting it to strong impact or vibration may cause trouble and/or malfunctioning.

Do not allow any foreign objects to enter inside the mainframe!

- Allowing water, metal items, scraps of food or other foreign objects inside the control panel may cause a fire and/or electric shocks.

Choosing the best installation location

- This unit is designed for indoor use only.
- Mount the mainframe securely in a standard 19-inch rack (with a depth dimension of at least 600 mm) that meets the EIA standard or its equivalent for use.
- Install the mainframe securely using screws that are compatible with the rack.
- Be absolutely sure to attach the support guides used to support the back part of the mainframe. (Provide support guides that are compatible with the rack.)
- Provide sufficient clearances from the area around the ventilation holes at the front and the cooling fan at the back.
- Do not install the mainframe in a cold place where the temperatures will drop below 32 °F (0 °C) or in a hot place where the temperatures will rise above 104 °F (40 °C).
- Avoid installing the mainframe where it will be exposed to direct sunlight or to the hot air that is blown out from other products.
- Installing the mainframe in a very humid, dusty or vibration-prone location may give rise to trouble.

Support guides

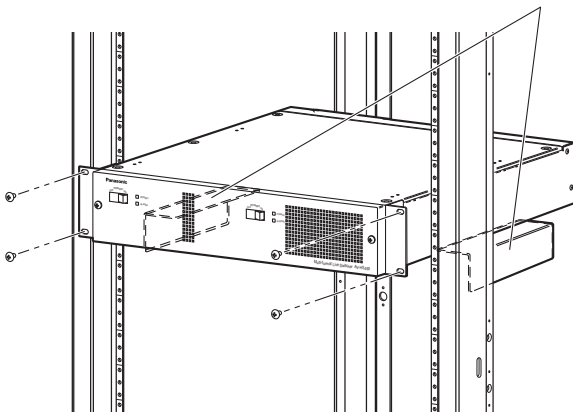

Installation in a rack

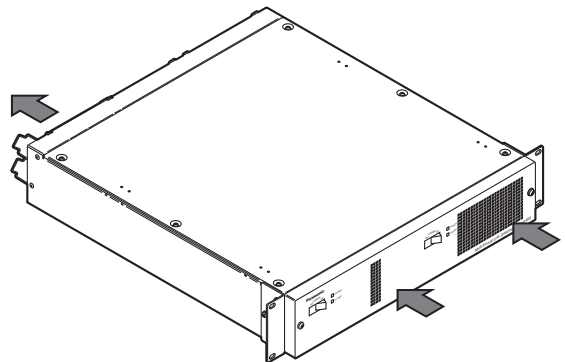

Flow of air through the ventilation holes

1. Installation

1-3. How to install the option boards

The option boards are installed in the mainframe.

For details, refer to the operating instructions of the option board concerned.

Notes

- Be absolutely sure to ask your dealer to do the job of installing or removing the option boards.
- Before installing or removing an option board, turn off the power, and disconnect the power plug.
- Before coming into physical contact with the option board, touch your hand to metal that has been grounded to discharge the static electricity in your body.

A safe way to proceed is to wear an anti-static wrist strap.

The option board may be damaged if you touch the board with static still in your body.

- Avoid damage to the option board by not dropping it or subjecting it to strong shocks or vibrations.
- After removing an option board, be absolutely sure to attach the blank panel.
- When installing or removing an option board, take care not to hurt yourself on the edges or metal parts of the board.

① Turn off the power of the mainframe, and disconnect the power cord.

② Loosen the two screws of SLOT A or SLOT B at the back of the mainframe, and remove the blank panel.

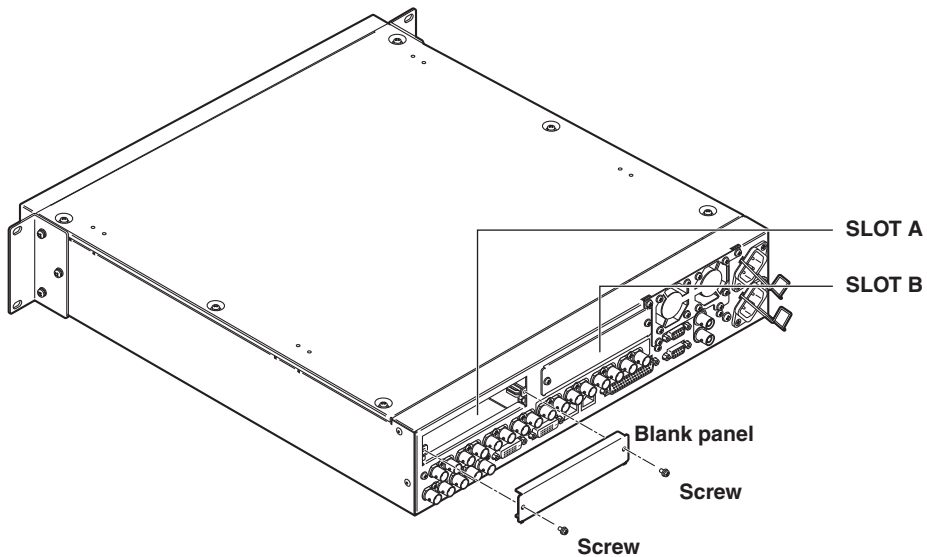

1. Installation

- ③ Align the option board with the guide rails, and insert it slowly.
Insert it until it will go no further. Take care not to exert excessive force while doing this since that may damage the connector inside.
- ④ Mount the option board in place using the two screws.
Clamping torque: 0.7 N•m

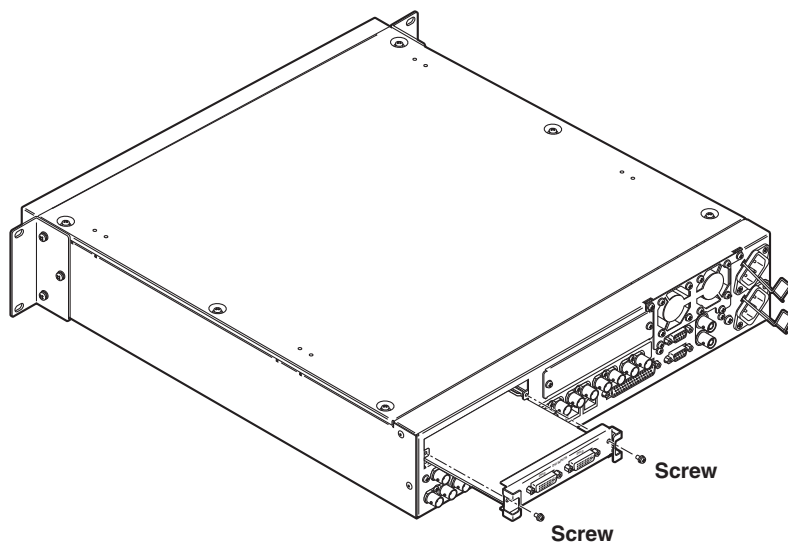

- ⑤ After connecting the necessary cables, plug the power cord into the power outlet, and turn on the power.

1. Installation

1-4. Connections

1-4-1. Block diagram

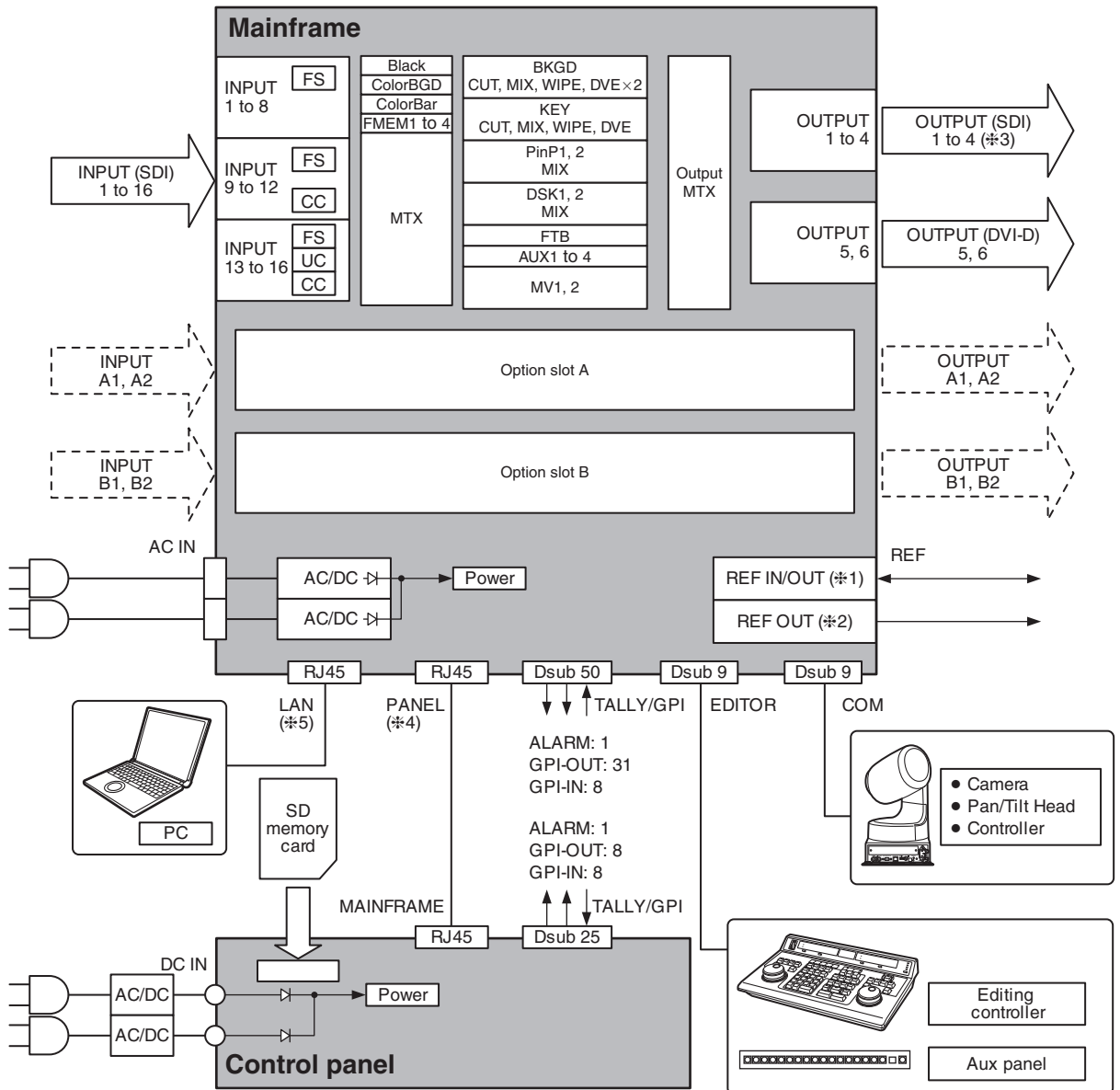

*1: When external synchronization is selected as the reference signal setting, the reference signal is input. When internal synchronization is selected, the reference signal is output.

*2: When external synchronization is selected as the reference signal setting, the signals are looped through and output. When internal synchronization is selected, the reference signal is output.

*3: Two sets of the same output signals are distributed from OUTPUT (SDI) 1.

*4: Connect the PANEL connector directly to the MAINFRAME connector using the supplied CAT5E cable.

*5: Do not connect to a public line when connecting a PC.

1. Installation

1-4-2. Connections when implementing gen-lock (frame synchronizer OFF)

Sync Generator

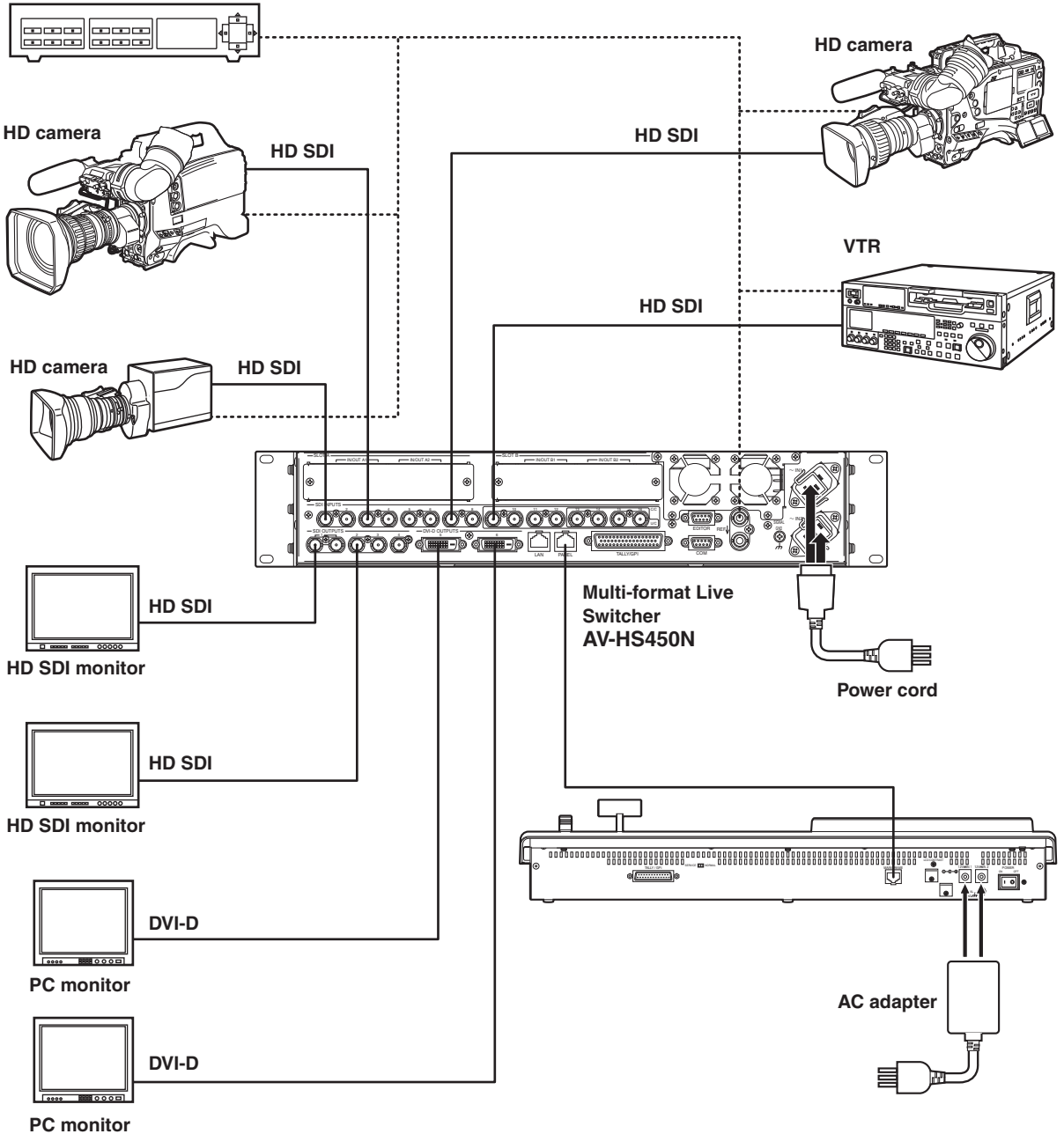

- When the unit is to be installed and when the connections are to be performed, be absolutely sure to ask your dealer to be responsible for carrying out the work that needs to be done.
- Use a 3-point power outlet as the power source in order to earth the unit securely.

1. Installation

1-4-3. Connections when not implementing gen-lock (frame synchronizer ON)

Example where the optional board is used

SLOT A: Analog Input Board (AV-HS04M2)
SLOT B: Full-HD DVI Input Board (AV-HS04M8)

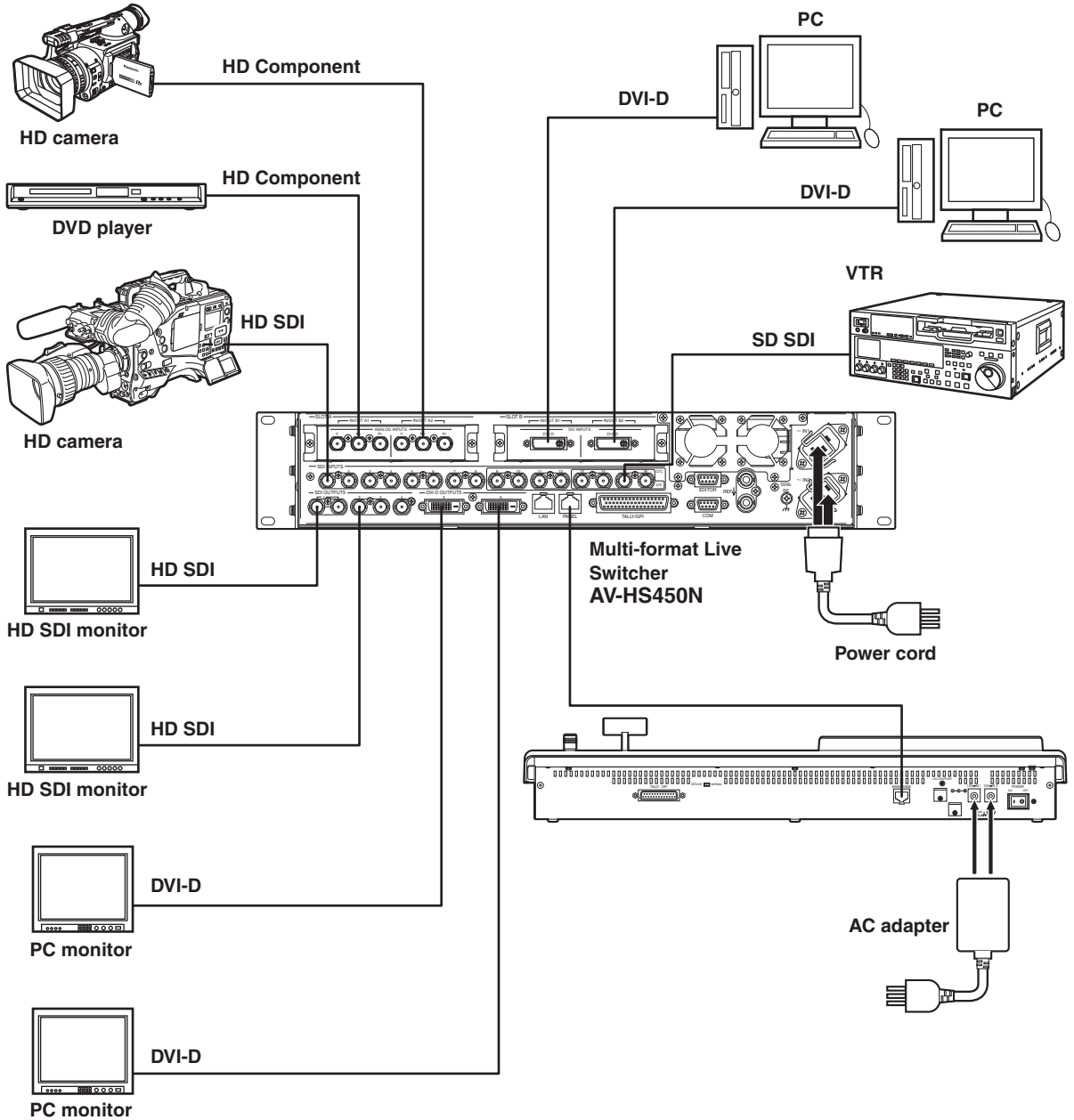

2. Functions in each area

2-1. Control panel

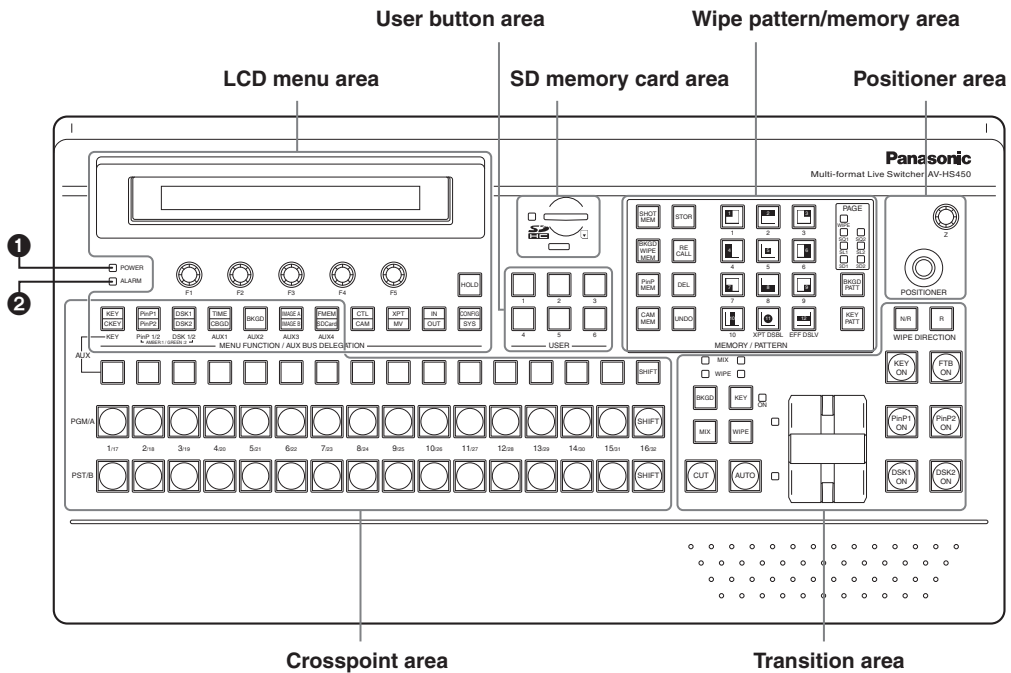

1 Power indicator [POWER]

This indicator lights when the power switch (39) on the rear panel is set to ON while power is supplied to the DC power input socket.

It goes off when the power switch (39) is set to OFF.

2 Alarm indicator [ALARM]

This indicator lights when the mainframe's cooling fan has stopped running or when there is a problem (voltage drop) with the power supply of the mainframe or the control panel.

When this occurs, an alarm message is displayed on the LCD and on the OSD screen of the external monitor.

During the occurrence of an alarm, details of the trouble can be checked using the SYSTEM/Alarm menu.

Alarm information can be output to an external device from the control panel's TALLY/GPI connector (35).

☞ For details, refer to "5-8-2. Alarm message".

If the alarm goes off, stop using the unit immediately and be sure to contact your dealer.

Continuing to use the unit even after the alarm goes off could damage it.

2. Functions in each area

2-1-1. Crosspoint area

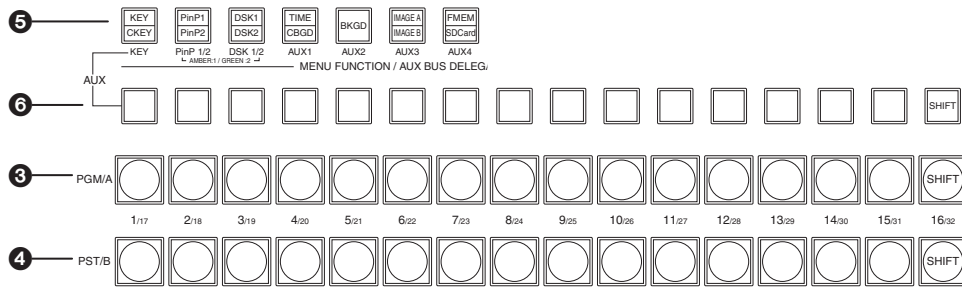

③ PGM/A bus crosspoint buttons [PGM/A 1 to 32]

These are used to select the PGM/A bus video signals.

Buttons 1 to 32 can be selected using the [SHIFT] button.

☞ Refer to “3-1-2. Selecting the bus using the SHIFT function”.

In the case of the flip-flop system, the main line video (PGM) signals are always selected.

When one of the crosspoint buttons (③, ④, ⑥) is held down, the name of the input material and the number of the crosspoint button are displayed.

④ PST/B bus crosspoint buttons [PST/B 1 to 32]

These are used to select the PST/B bus video signals.

Buttons 1 to 32 can be selected using the [SHIFT] button.

☞ Refer to “3-1-2. Selecting the bus using the SHIFT function”.

In the case of the flip-flop system, the images inserted next (PST) are always selected.

⑤ AUX bus selector buttons [KEY, PinP 1/2, DSK 1/2, AUX1 to AUX4]

Select the bus to be operated using the AUX bus crosspoint buttons (⑥).

The selected button lights.

[KEY]:

This button is used to change the AUX bus crosspoint buttons (⑥) into the selector buttons for the sources of the key fill buses.

The source for the key source bus can be set using the menu displayed when the AUX bus crosspoint buttons (⑥) are held down. The set source will be the same for DSK1 and DSK2.

The source can also be set from the CONFIG menu.

[PinP 1/2]:

This button is used to change the AUX bus crosspoint buttons (⑥) into the selector buttons for the sources of the PinP buses.

Each time it is pressed, its target is switched between PinP1 and PinP2.

When PinP1 is selected, the button lights in amber; when PinP2 is selected, it lights in green.

[DSK 1/2]:

This button is used to change the AUX bus crosspoint buttons (⑥) into the selector buttons for the sources of the DSK fill buses.

Each time it is pressed, its target is switched between DSK1 and DSK2.

When DSK1 is selected, the button lights in amber; when DSK2 is selected, it lights in green.

[AUX1] - [AUX4]:

These buttons are used to change the AUX bus crosspoint buttons (⑥) into the selector buttons for the sources of the AUX buses.

The AUX bus selector buttons are also used as the menu function buttons (Ⓑ).

2. Functions in each area

6 AUX bus crosspoint buttons

These buttons are used to select the source of the bus which was selected by the AUX bus selector button (5). Buttons 1 to 32 can be selected using the [SHIFT] button.

Refer to “3-1-2. Selecting the bus using the SHIFT function”.

2-1-2. Wipe pattern/memory area

7 Wipe pattern and memory selector buttons

Wipe patterns 1 to 12 can be selected while the BKGD and KEY pattern selector buttons (8) are lighted.

Data can be stored in the memories of buttons 1 to 10 or recalled from these memories while one of the memory operation buttons (10) — [SHOT MEM], [BKGD WIPE MEM], [PinP MEM] or [CAM MEM] — is lighted.

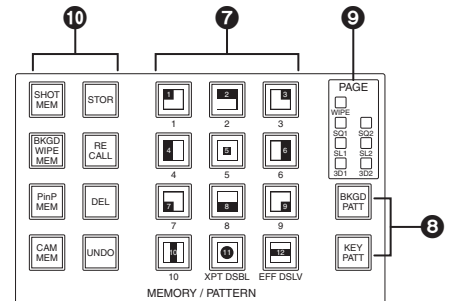

8 BKGD, KEY pattern selector buttons [BKGD PATT] [KEY PATT]

Press the [BKGD PATT] button, and while it is lighted, select the wipe pattern for the background transition.

Similarly, press the [KEY PATT] button, and while it is lighted, select the wipe pattern for the key transition.

Each time the [BKGD PATT] button and [KEY PATT] button are pressed, the pattern page changes in the following sequence: WIPE, SQ1 (squeeze 1), SL1 (slide 1), 3D1 (3 dimensions 1), SQ2 (squeeze 2), SL2 (slide 2) and 3D2 (3 dimensions 2). Which pattern page has been selected can be checked by observing which pattern page indicator LED (9) is lighted.

SQ2, SL2, and 3D2 may not be selected as the wipe pattern for the key transition.

9 Pattern page indicator LEDs [PAGE]

By observing which pattern page indicator LED is lighted, it is possible to check which pattern page has been selected by the BKGD PATT or KEY PATT selector button (8).

10 Memory operation buttons [SHOT MEM] [BKGD WIPE MEM] [PinP MEM] [CAM MEM] [STOR] [RECALL] [DEL] [UNDO]

Press the [SHOT MEM], [BKGD WIPE MEM], [PinP MEM] or [CAM MEM] button to perform the memory operations for the number keys (1 to 10).

[STOR]:

Press this to register data in the memory.

[RECALL]:

Press this to recall data from the memory.

[DEL]:

Press this to delete data in the memory.

[UNDO]:

Press this to undo the operation of the [RECALL] or [DEL] button.

The number of operations that can be undone is one only.

This operation cannot be performed using memory operations when the [CAM MEM] button has been pressed.

2. Functions in each area

2-1-3. User button area

① User buttons [USER1 to USER6]

These are used to assign some functions of the menu settings to the [USER1] to [USER6] buttons on the CONFIG menu.

☞ See “5-3-1. Setting the user buttons”.

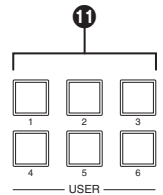

2-1-4. Transition area

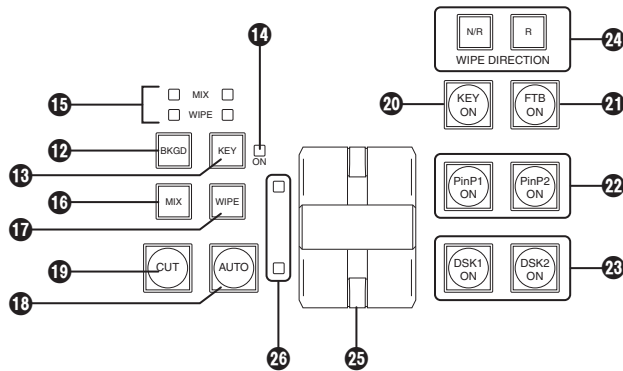

⑫ [BKGD] button

This executes the background transition when the [AUTO] button (⑬) or fader lever (⑳) has been operated. When the [BKGD] button is pressed and it is selected, its indicator lights in amber. If the [KEY] button (⑬) is now pressed, the indicator goes off, and the de-selected status is established. When the [BKGD] button and [KEY] button (⑬) are pressed at the same time, both buttons are set to the selected status.

⑬ [KEY] button

This executes the key transition when the [AUTO] button (⑬) or fader lever (⑳) has been operated. When the [KEY] button is pressed and it is selected, its indicator lights in amber. If the [BKGD] button (⑫) is now pressed, the indicator goes off, and the de-selected status is established. When the [BKGD] button (⑫) and [KEY] button are pressed at the same time, both buttons are set to the selected status.

⑭ KEY ON tally LED

This lights in red when the key ON status is established.

⑮ MIX, WIPE selection status tally LEDs

These light up to indicate whether MIX or WIPE has been selected when background transitions or key transitions are executed.

2. Functions in each area

16 [MIX] button

This is used to switch the A and B bus images while making them overlap.

During the transition, the A and B bus output total is kept at 100 %.

When the [MIX] button is pressed and it is selected, its indicator lights in amber.

If the [WIPE] button (17) is now pressed, it goes off, and the de-selected status is established.

17 [WIPE] button

This is used to execute the transition using the pattern selected by the wipe pattern selector button (7).

When the [WIPE] button is pressed and it is selected, its indicator lights in amber.

If the [MIX] button (16) is now pressed, it goes off, and the de-selected status is established.

18 [AUTO] button

This is used to automatically execute transitions (auto transition) using the transition time which has been set on the TIME menu.

During auto transition its indicator lights in amber. When the button is pressed again during auto transition, the auto transition operation is suspended, and the indicator lights in green. When it is pressed again while auto transition is suspended, the remaining transition is executed.

The indicator goes off when auto transition is completed.

When the [AUTO] button is pressed while the fader lever (25) is at an interim setting, the transition is executed in the time remaining from the interim setting.

19 [CUT] button

This button is used to execute transitions instantly.

Its indicator lights in amber during a transition, and it goes off when the transition is completed.

20 [KEY ON] button

This button is used to execute the key transition for the transition time which has been set on the TIME menu.

21 [FTB ON] button

This button is used to execute fade-out to a black screen or fade-in from a black screen for the transition time which has been set on the TIME menu.

22 PinP button [PinP1 ON] [PinP2 ON]

This button is used to execute fade-in or fade-out of the picture in picture for the transition time which has been set on the TIME menu.

23 DSK button [DSK1 ON] [DSK2 ON]

This button is used to execute fade-in or fade-out of downstream key for the transition time which has been set on the TIME menu.

2. Functions in each area

24 Wipe direction selection buttons [WIPE DIRECTION N/R, R]

These buttons are used to select the direction in which to wipe for executing background transitions.

When the [R] indicator is off:

Wiping proceeds in the normal direction.

When the [R] indicator is lighted:

Wiping proceeds in the reverse direction.

When the [N/R] indicator is lighted:

The normal direction is replaced with the reverse direction (or vice versa) when the transition is completed. (The lighted and extinguished statuses of the [R] button are also switched in line with the direction of the wiping.)

25 Fader lever

This is used to execute background or key transitions. When it is moved as far as it will go, the transition is completed. When it has been operated during auto transition, auto transition will be switched to manual operation as soon as the fader position overtakes the amount of the transition being executed.

26 Bus tally LEDs

These indicate the output statuses of the A bus and B bus. The LED corresponding to the bus whose program signals (PGM) are being output lights.

2. Functions in each area

2-1-5. LCD menu area

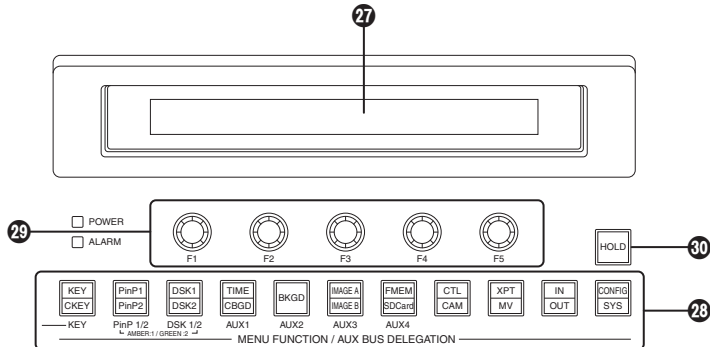

27 LCD

The setting menu is displayed when one of the menu function buttons (28) is pressed.

When the buttons listed below are double-clicked, the specified menu is selected. (The menu delegation function)

The operation corresponding to the button pressed is also executed.

<List of menu delegation functions>

	Button	Menu
Transition area	BKGD	TIME menu/BKGD sub menu
	KEY	TIME menu/KEY sub menu
	WIPE	BKGD menu/Border sub menu
Wipe pattern area	WIPE #5 (BKGD)	BKGD menu/WIPEPos sub menu
	WIPE #5 (KEY)	KEY menu/WIPEPos sub menu
	WIPE #11 (BKGD)	BKGD menu/WIPEPos sub menu
	WIPE #11 (KEY)	KEY menu/WIPEPos sub menu
	SQ #5 (BKGD)	BKGD menu/SQPos sub menu
	SQ #5 (KEY)	KEY menu/SQPos sub menu
	SL #5 (KEY)	KEY menu/FlyKEY sub menu

2. Functions in each area

28 Menu function buttons [MENU FUNCTION/AUX BUS DELEGATION]

These are used to select the menus organized by function.

Each time one of these buttons is pressed, the menu for its function is switched between the one displayed above and the one displayed below. Each time the [PinP1/PinP2] button or [DSK1/DSK2] button is pressed, the color used for their lighting is switched between amber and green. The other buttons light in amber.

29 Rotary encoders [F1] to [F5]

These are used to set the parameters displayed on the menus (LCD screen or on-screen display).

For details on the operations, refer to the sections in “3. Basic operations”.

[F1]: Rotate this rotary encoder to switch the sub menu.
On the INPUT menu or OUTPUT menu, the signal to be set is switched.

[F2]: Turn this rotary encoder to set the parameters.
On the INPUT menu or OUTPUT menu, the third menu is switched.

[F3] to [F5]: Rotate these rotary encoders to set the parameters.
When the down arrow (↓) is shown at a menu item, its parameter is set by pressing the corresponding rotary encoder.

When the parameter is one which is set using a numerical value, its default will be restored when the rotary encoder is held down.

(However, the network settings and the date and time settings will not be returned to the defaults.)

Basic menu operations

For detailed operations, refer to the sections in “3. Basic operations”.

For the menu configurations, refer to “8. Setting menu table”.

- ① Select the menus organized by function using the menu function buttons (28).
- ② Using the rotary encoders (29), display the sub menu that will be used to establish the detailed settings, and set the parameters.

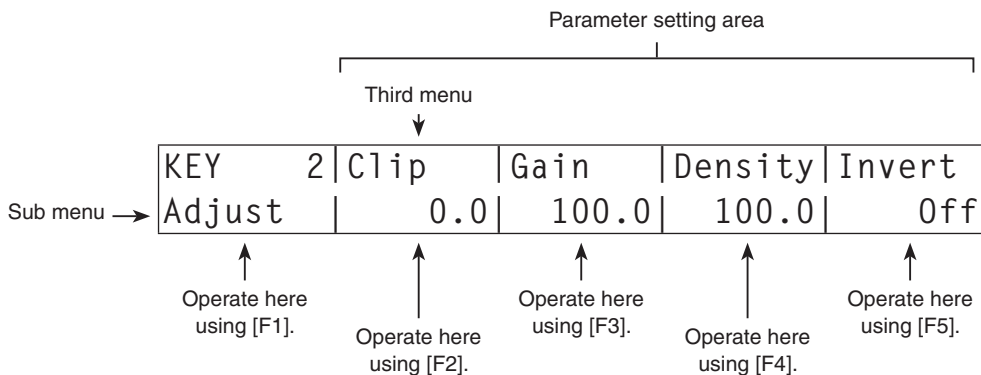

- The INPUT menu and OUTPUT menu differ depending on whether an option board has been installed.

30 [HOLD] button

If the [HOLD] button is pressed while a menu is displayed, no other menu will be selected even when a menu function button (28) is pressed.

In addition, even if the AUX bus selection button (5) is pressed it will not switch to another bus.

While the [HOLD] button is held down, it lights in amber.

2. Functions in each area

2-1-6. Positioner area

31 Positioner [X/Y]

These are used when performing the settings below.

- PinP1, PinP2 position settings
- Wipe start position setting (WIPE #5, WIPE #11, SQ #5)
- Camera control
- Flying key position setting
- Chroma key marker position setting

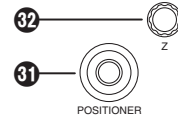

In each case, the settings take effect only when the following menu items have been selected.

Note

The center values of the positioner are set during the time it takes for the unit to start up after its power is turned on. Do not operate the positioner until after the switcher has started up.

32 Rotary encoder [Z]

This is used to set the PinP size, flying key size or to select the chroma key area.

In each case, the settings take effect only when the following menu items have been selected.

	Positioner	Rotary encoder		Valid menu
	X/Y	Z	Switch	
PinP1, PinP2	Position adjustments	Size adjustments (size increased by rotating the encoder clockwise and reduced by rotating it counterclockwise)	Hold switch down to restore initial values (X/Y, Z).	All PinP1 and PinP2 menus (except for PinP1, PinP2/Rotation)
	Rotation angle adjustments (X-direction and Y-direction rotation)	Rotation angle adjustments (Z-direction rotation)	Hold switch down to restore initial values (X/Y, Z).	PinP1, PinP2/Rotation
WIPE (BKGD)	Start position adjustments	—	Hold switch down to restore initial values (X/Y).	BKGD/WIPEPos BKGD/SQPos
WIPE (KEY)	Start position adjustments	—	Hold switch down to restore initial values (X/Y).	KEY/WIPEPos KEY/SQPos
Chroma key	Selection position adjustments	Selected area size adjustments (size increased by rotating the encoder clockwise and reduced by rotating it counterclockwise)	Execute sampling	CHR KEY/Sample1 CHR KEY/Sample2
Flying key	Position adjustments	Size adjustments (size increased by rotating the encoder clockwise and reduced by rotating it counterclockwise)	Hold switch down to restore initial values (X/Y, Z).	KEY/FlyKEY
Camera control	X: Pan control or focus control Y: Tilt control or zoom control	—	Switching between pan/tilt control and zoom/focus control	All menus other than those listed above

2. Functions in each area

2-1-7. SD memory card area

③③ SD memory card slot

Insert an SD memory card (purchased separately) or an SDHC memory card (purchased separately) into this slot.

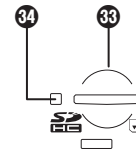

③④ SD memory card access LED

This LED lights while the data on the SD memory card is being accessed.

Do not turn off the unit's power or eject the SD memory card while the access LED is lighted. Doing so can damage the data on the SD memory card.

Concerning the recommended SD memory cards and SDHC memory cards

Use of the following SD memory cards and SDHC memory cards made by Panasonic is recommended:

SDHC memory cards	RP-SDM04G, RP-SDM06G, RP-SDM08G, RP-SDM12G, RP-SDM12G
	RP-SDV04G, RP-SDV08G, RP-SDV16G, RP-SDV32G
SD memory cards	RP-SD128B, RP-SD256B
	RP-SDR512
	RP-SDM01G, RP-SDM02G
	RP-SDV512, RP-SDV01G, RP-SDV02G

2. Functions in each area

2-1-8. Rear panel connections area

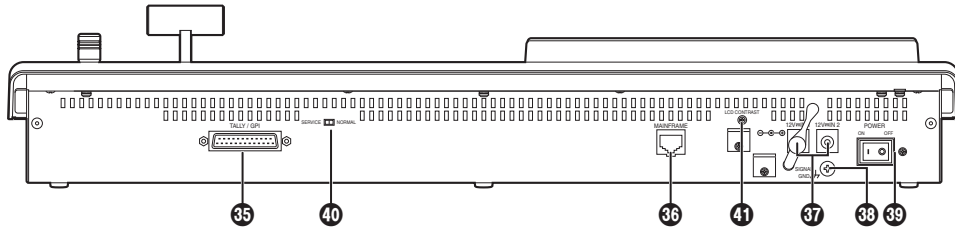

35 TALLY/GPI input/output connector [TALLY/GPI] (D-sub 25-pin, female, inch screw)

For details on how to connect this connector, refer to “6. External interfaces”.

36 MAIN FRAME connector [MAIN FRAME] (RJ-45) (100 Base-TX)

Connect this to the mainframe using the supplied CAT5E cable (STP, straight, 10 m).

37 DC power input sockets [12V IN1], [12V IN2] (DC 12 V, 0.8 A)

Connect the supplied AC adapters (for the control panel) to these sockets.

38 Ground connector [SIGNAL GND]

Connect to the system's earth ground.

39 Power switch [POWER]

This is used to turn the power on and off.

40 SERVICE switch [NORMAL/SERVICE]

This switch is used for maintenance purposes.
For normal operations, select the “NORMAL” position.

41 LCD CONTRAST adjustment screw

This is used to adjust the contrast of the LCD display.

2. Functions in each area

2-2. Mainframe

2-2-1. Front panel

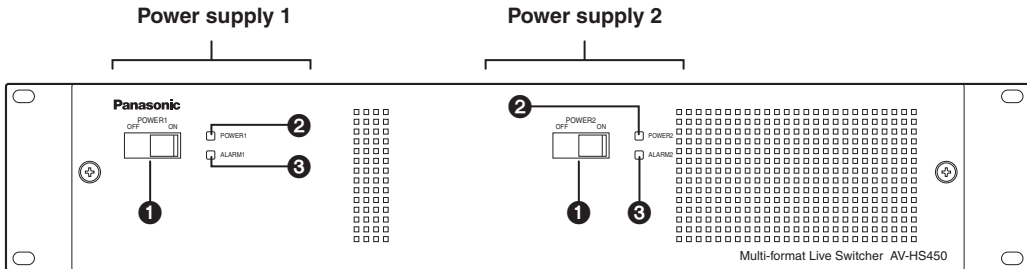

❶ Power switch [POWER1, POWER2]

These are used to turn the power on and off.

As a standard feature, this mainframe has a redundant power supply system.

To turn off the power, set the power switches of both system 1 (POWER1) and system 2 (POWER2) to OFF.

❷ Power indicator [POWER1, POWER2]

This indicator lights when the power switch (❶) is set to ON while power is supplied to the AC power input socket.

It goes off when the power switch (❶) is set to OFF.

❸ Alarm indicator [ALARM1, ALARM2]

These light when the mainframe's cooling fan has stopped running or when there is a problem (voltage drop) in the power supply. When this occurs, an alarm message is displayed on the control panel's LCD and on the OSD screen of the external monitor.

During the occurrence of an alarm, details of the trouble can be checked using the SYSTEM/Alarm menu.

The alarm information can be output to an external device from the TALLY/GPI connector (❶❹) of the mainframe.

☞ For details, refer to "5-8-2. Alarm message".

If the alarm goes off, stop using the unit immediately and be sure to contact your dealer.

Continuing to use the unit even after the alarm goes off could damage it.

2. Functions in each area

2-2-2. Rear panel connections area

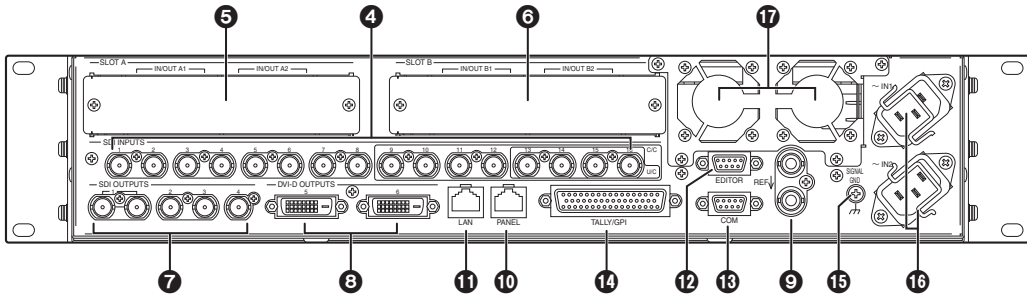

4 SDI signal input connectors [SDI INPUTS 1 to 16]

9 to 16: The color collector function can be used.

13 to 16: The up-converter function can be used.

5 Option slot [SLOTA] (IN/OUT A1, IN/OUT A2)

6 Option slot [SLOTB] (IN/OUT B1, IN/OUT B2)

Each of these is an input/output option slot.

A DVI input board, analog output board or other option board can be installed in these slots.

For details, refer to "1-3. How to install the option boards" and the operating instructions of the board concerned.

7 SDI signal output connectors [SDI OUTPUTS 1 to 4]

1 to 4: These can be allocated by the menus.

- Two sets of the same output signals are distributed from the OUTPUT1 connector.

8 DVI-D output connectors [DVI-D OUTPUTS 5, 6]

These can be allocated by the menus.

- The DVI-I connector cable cannot be used.

9 Reference input connector/BB output connector [REF]

Loop-through output in the external sync mode.

If the loop-through output is not going to be used, provide a 75-ohm termination.

BB signals output from both connectors in the internal sync mode.

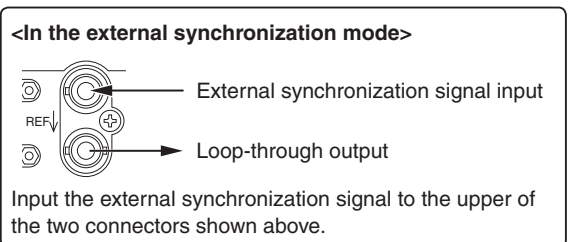

10 PANEL connector [PANEL] (RJ-45) (100 Base-TX)

Connect this to the control panel using the supplied CAT5E cable (STP, straight, 10 m).

2. Functions in each area

11 LAN connector [LAN] (RJ-45) (10/100 Base-TX)

☞ For details on how to connect this connector, refer to “6. External interfaces”.

12 EDITOR connector [EDITOR] (RS-422, D-sub 9-pin, female, inch screw)

13 COM connector [COM] (RS-422, D-sub 9-pin, female, inch screw)

☞ For details on how to connect this connector, refer to “6. External interfaces”.

14 TALLY/GPI input/output connector [TALLY/GPI] (D-sub 50-pin, female, inch screw)

☞ For details on how to connect this connector, refer to “6. External interfaces”.

15 Ground connector [SIGNAL GND]

Connect to the system's earth ground.

16 AC power input socket [~ IN1] [~ IN2] (AC 100 V to 120 V, 50/60 Hz)

Connect one end of the supplied power cable to this socket and the other end to the AC outlet.

The supplied power cable comes with a 3-pin power plug. Be absolutely sure to plug it into a 3-point power outlet as the power source in order to earth the unit securely.

If a 3-point power outlet is not available for this connection, be absolutely sure to consult your dealer.

17 Cooling fan

3. Basic operations

3-1. Background transition

3-1-1. Selecting the bus

Press one of the crosspoint buttons to select the material to be used for the background transition. Depending on the operating status, the button pressed will light in one of two colors.

Lighting in red: When the selected input signals are output to PGM.
(However, the indicator lights in amber during FTB operations.)

Lighting in green: When the selected input signals are not output to PGM.

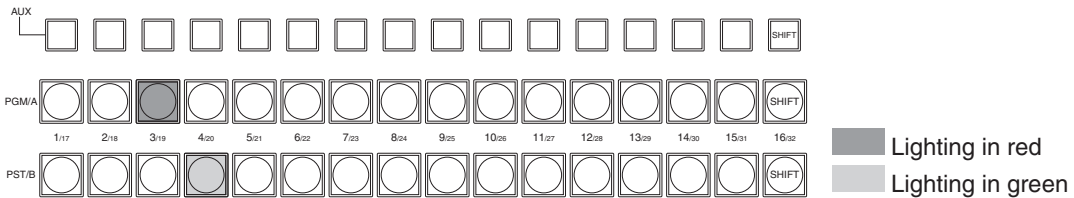

Furthermore, when one of the crosspoint buttons is held down, the name of the input material and number of the button corresponding to the pressed button are displayed on the LCD.

3-1-2. Selecting the bus using the SHIFT function

The SHIFT function enables two materials to be allocated — the front material and the rear material — to one button, and the materials to be selected using the [SHIFT] button.

A total of 32 materials — front materials (1 to 16) and rear materials (17 to 32) — can be allocated to the three groups of 16 crosspoint buttons whether these buttons are the PGM/A bus crosspoint buttons, PST/B bus crosspoint buttons or AUX bus crosspoint buttons.

There are actually two SHIFT functions: “All SHIFT” for switching all the front materials to the rear materials or vice versa, and “Single SHIFT” for switching the front material of one crosspoint button with its rear material or vice versa.

“All SHIFT” works once the SHIFT function has been allocated to one of the USER buttons.

“Single SHIFT” works once the SHIFT function has been allocated to the No.16 or No.1 crosspoint button of the crosspoint button group concerned by a menu operation.

3. Basic operations

All SHIFT

All SHIFT is used to switch all the materials of the PGM/A bus crosspoint buttons, PST/B bus crosspoint buttons or AUX bus crosspoint buttons from front materials to rear materials or vice versa. The USER button to which the SHIFT function has been allocated is used to switch between the front materials and rear materials.

- ① Allocate the SHIFT function to one of the USER buttons.
For the method used to allocate this function to the USER button, refer to “5-3-1. Setting the user buttons”.
- ② Each time the [SHIFT] (USER) button is pressed, the front materials are switched to the rear materials or vice versa.
 - When the rear materials (17 to 32) have been selected, the [SHIFT] (USER) button lights in amber.
 - When the button is pressed again, it goes off, and the front materials (1 to 16) are now selected.

Single SHIFT

Single SHIFT is used to switch the material of a PGM/A bus crosspoint button, PST/B bus crosspoint button or AUX bus crosspoint button from a front material to a rear material or vice versa. Switching between the front material and rear material is done using the crosspoint button (No.16 or No.1) in which the SHIFT function is allocated.

■ Allocating the SHIFT function

- ① Press the [XPT] button to light its indicator, and display the XPT menu.
☞ Refer to “2-1-5. LCD menu area”.
- ② Turn [F1] to display the XPTAsing sub menu.

<Menu display>

XPT	5	XPT	Signal	Shift	Sf-Lock
XPTAsing		-	-	Right	Off

1~32	IN1~16	Left	0n
	IN-A1	Off	
	IN-A2		
	IN-B1		
	IN-B2		
	Black		
	CBGD		
	CBAR		
	FMEM1~4		
	PGM		
	PVW		
	CLN		
	MV1		
	MV2		
	None		

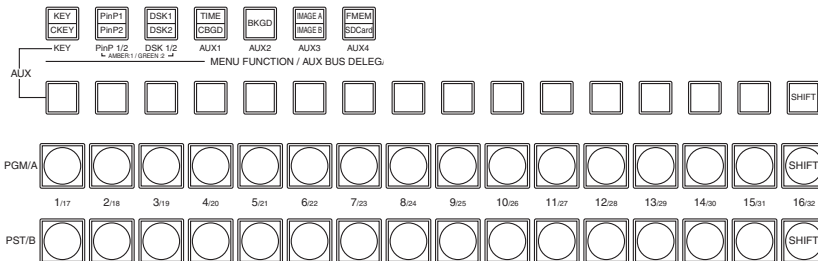

3. Basic operations

③ Turn [F4] to select the button to which the SHIFT function is to be allocated using the Shift item.

Right: Button No.16

Left: Button No.1

Off: Function is not allocated.

④ Turn [F5] to select the operation to be performed when the [SHIFT] button is pressed using the Sf-Lock item.

Off: The rear material is selected only while the [SHIFT] button is pressed.

On: The front material and rear material are switched each time the [SHIFT] button is pressed.

- To use the materials that have been set in the button to which the SHIFT function is allocated, either set the SHIFT function off or allocate the SHIFT function to another button.
- If a rear material has been selected regardless of whether the Sf-Lock item is On or Off, both the button concerned and the [SHIFT] button will light in amber.
When PGM/PST is selected as the bus mode setting or when the bus has been switched by a transition, the SHIFT status will also be switched.
- If the [SHIFT] button for “Single SHIFT” is pressed when the rear materials (17 to 32) have been selected using “All SHIFT”, the bus crosspoint buttons concerned will be switched to the front materials.
- When a crosspoint button is held down, the input material allocated to the pressed button is displayed on the LCD.
When the [SHIFT] button is held down, “Shift” is displayed on the LCD.

3. Basic operations

3-1-3. Selecting the bus mode

Select the A/B bus system or flip-flop system (PGM/PST system) from the setting menu.

- ① Press the [CONFIG] button to light its indicator, and display the CONFIG menu.
☞ Refer to “2-1-5. LCD menu area”.
- ② Turn [F1] to display the Operate sub menu.
- ③ Turn [F2], and select the A/B or PGM/PST (flip-flop system) using the BusMode item.

<Menu display>

CONFIG 1	BusMode	LCD-BL	MENU DLG	
Operate	PGM/PST	0n	0n	
	A/B	0ff	0ff	
		60		
		120		
		180		

With the flip-flop system (PGM/PST), the PGM/A bus selected signals are always output as PGM images, and the PST/B bus selected signals are always output as PVW (PST) images.

System	Video output	Before transition	During transition	After transition completion
A/B	PGM	PGM/A	PGM/A, PST/B	PST/B
	PVW (PST)	PST/B	PST/B	PGM/A

- With an A → B transition

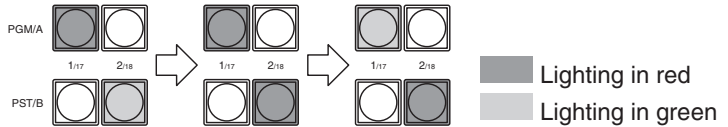

System	Video output	Before transition	During transition	After transition completion
Flip-flop PGM/PST	PGM	PGM/A	PGM/A, PST/B	PGM/A
	PVW (PST)	PST/B	PST/B	PST/B

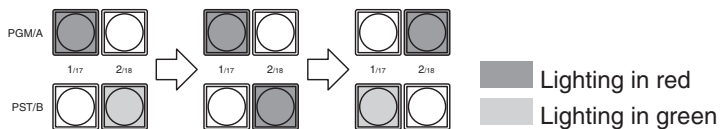

3. Basic operations

3-1-4. Selecting the transition mode

Press the [BKGD] button in the transition area so that its indicator lights in amber.
When the [BKGD] button and [KEY] button are pressed at the same time, both buttons are selected.

Use the [MIX] and [WIPE] buttons in the transition area to select the background transition mode.
The indicator of the selected button lights in amber.

3-1-5. Manual transition (using the fader lever)

Operate the fader lever to execute transitions manually.
If the fader lever has been operated during auto transition, auto transition will be switched to manual operation as soon as the fader position overtakes the amount of the transition being executed.
The bus tally LEDs on the left of the fader lever indicate the program bus output status.

- Top LED only lights:** PGM/A bus output
- Top and bottom LEDs light:** during the transition
- Bottom LED only lights:** PST/B output

3-1-6. Auto transition

- When the [AUTO] button is pressed, the transition is executed automatically using the transition time which has been set.
- When the [AUTO] button is pressed while the fader lever is at an interim setting, the transition is executed in the time remaining from the interim setting.
- The auto transition time is set using the TIME menu.

① Press the [TIME] button to light its indicator, and display the TIME menu.

☞ Refer to “2-1-5. LCD menu area”.

② Turn [F1] to display the BKGD sub menu.

③ Turn [F4] to select the display unit using the Unit item.

④ When frames (Frame) have been selected as the unit, turn [F3] to set the transition time.

⑤ When seconds (Sec) have been selected as the unit, turn [F2] to set the second units or [F3] to set the frame units.

<Menu display>

TIME	1	TransTime	Unit	
BKGD		16s	39f	Sec

TIME	1	TransTime	Unit	
BKGD			999f	Frame

- Any time from 0 to 999f can be set. The time which can be set when seconds are used as the display unit differs depending on the video format.

59.94i: max. 33s09f, **59.94p:** max. 16s39f, **50i:** max. 39s24f, **50p:** max. 19s49f,

24psf: max 41s15f, **23.98psf:** max 41s15f

3-1-7. Cut transition

When the [CUT] button is pressed, the transition is executed instantly.

3. Basic operations

3-2. IMAGE

3-2-1. Setting the IMAGE effects

Three effects — paint, mono-color, mosaic and defocus — can be set for the PGM/A bus materials and PST/B bus materials.

- ① Press the [IMAGE A] button (or the [IMAGE B] button) to light its indicator, and display the IMAGE A (or IMAGE B) menu.
 ☞ Refer to “2-1-5. LCD menu area”.
- ② Turn [F2], and set the IMAGE effect to On or Off.
 To add the IMAGE effect, set to On.

<Menu display>

IMAG A 1	On/Off			
IMAG A	Off			

On

- ③ Turn [F1] to display the menu (Paint, Mono, Mosa/Def sub menu) of the effect that is to be set.

<Menu display>

IMAG A 2	On/Off	Y-Level	C-Level
Paint	Off	0	0

On 0~7 0~7

IMAG A 3	On/Off	Hue	Sat
Mono	Off	0.0	0.0

On 0.0 0.0
 | |
 359.9 100.0

IMAG A 4	On/Off	Mode	Effect
Mosa/Def	Off	Mosaic	20.0

On Defocus 0.0
 |
 100.0

- ④ Turn [F2], and set On or Off using the sub menu concerned.
 - ⑤ Turn [F3] and [F4], and change the effect setting.
- Executing the transition when the PGM/PST (flip-flop system) is selected in the BusMode item of the Operate submenu of the CONFIG menu replaces the PGM/A bus with the PST/B bus, and the menu title “IMAG A” is also replaced with “IMAG B”.

3. Basic operations

3-2-2. Executing the IMAGE effect

While the IMAGE effect is set to On, the crosspoint button with the bus material to which the IMAGE effect has been added now blinks.

The IMAGE effects are created as DVEs (digital video effects) so their output is delayed by one frame from the normal output.

Even when the IMAGE effect has been set to On only for the PGM/A bus or PST/B bus, the effects of both buses will be output with a 1-frame delay.

3. Basic operations

3-3. Wipe

3-3-1. Selecting the wipe pattern

Based on the wipe patterns allocated to 12 buttons, this unit has 7 pages of background transition patterns and 4 pages of key transition patterns. (Refer to "Table of wipe patterns".)
The images and number of the basic wipe patterns are displayed on the wipe pattern selector buttons.

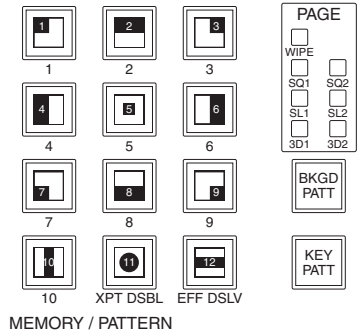

<How to select the wipe patterns>

- Press the [BKGD PATT] button or [KEY PATT] button to select the pattern page. Each time the button is pressed, the page is switched, and the selected PAGE LED lights.

Type of transition	Pattern page selection	PAGE LED lighting
Background	[BKGD PATT] button	WIPE → SQ1 → SL1 → 3D1 → SQ2 → SL2 → 3D2
Key	[KEY PATT] button	WIPE → SQ1 → SL1 → 3D1

- Select the button from among the 12 wipe pattern selector buttons for which the number of the pattern concerned is indicated. The selected pattern lights, and a wipe pattern image appears on the external monitor (OSD).

The pattern page indicator LEDs light only when the [BKGD PATT] button or [KEY PATT] button has been selected.

■ Table of wipe patterns

● Key transition pattern pages

WIPE			SQ1 (squeeze 1)			SL1 (slide 1)			3D1 (3 dimensions 1)		
1	2	3	1	2	3	1	2	3	1	2	3
4	5	6	4	5	6	4	5	6	4	5	6
7	8	9	7	8	9	7	8	9	7	8	9
10	11	12	10	11	12	10	11	12	10	11	12

3. Basic operations

• Background transition pattern pages

WIPE			SQ2 (squeeze 2)			SL2 (slide 2)			3D2 (3 dimensions 2)		
1	2	3	1	2	3	1	2	3	1	2	3
4	5	6	4	5	6	4	5 No pattern	6	4	5	6
7	8	9	7	8	9	7	8	9	7	8	9
10	11	12	10	11 No pattern	12	10 No pattern	11 No pattern	12 No pattern	10	11	12

SQ2 (squeeze 2)			SL2 (slide 2)			3D2 (3 dimensions 2)		
1 No pattern	2	3 No pattern	1 No pattern	2	3 No pattern	1 No pattern	2	3 No pattern
4	5 No pattern	6	4	5 No pattern	6	4	5 No pattern	6
7 No pattern	8	9 No pattern	7 No pattern	8	9 No pattern	7 No pattern	8	9 No pattern
10 No pattern	11 No pattern	12 No pattern	10 No pattern	11 No pattern	12 No pattern	10 No pattern	11 No pattern	12 No pattern

3. Basic operations

3-3-2. Selecting the background for the 3D2 pattern page

On the 3D2 (3 dimensions 2) pattern page, a still image in one of the frame memories (FMEM1-4), color background (CBGG) or Black can be selected for the background.

- ① Press the [BKGD] button to light its indicator, and display the BKGD menu.
 - ☞ Refer to “2-1-5. LCD menu area”.
- ② Turn [F1] to display the Base sub menu.

<Menu display>

BKGD	6	Type			
Base		Black			

FMEM1
FMEM4
CBGD

- ③ Turn [F2] to set the image to be used for the background using the Type item.
- The background that has been set takes effect when “3D2” is selected on the pattern page of the background transitions.

3-3-3. Selecting the wipe direction

Operate the wipe direction selector buttons to select the wipe direction for the background transition. (The key transitions are set by the menu. The direction which is set here will not be reflected. ☞ See “3-4-3. Key transitions”.)

When the [R] indicator is off:

Wiping proceeds in the normal direction.

When the [R] indicator is lighted:

Wiping proceeds in the reverse direction.

When the [N/R] indicator is lighted:

The normal direction is replaced with the reverse direction (or vice versa) when the transition is completed.

(The lighted and extinguished statuses of the [R] button are also switched in line with the direction of the wiping.)

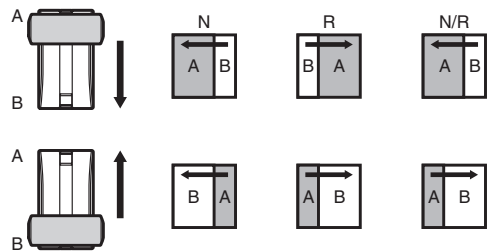

3. Basic operations

3-3-4. Wipe decorations (border, soft effect)

A border effect or soft effect can be added to the wiping of background transitions.

Setting the border and soft effect

- ① Press the [BKGD] button to light its indicator, and display the BKGD menu.
 ☞ Refer to “2-1-5. LCD menu area”.

<Menu display>

BKGD	1	Border	Width	Soft
Border		Off	5.0	0.0
		On	0.1	0.0
			100.0	100.0

- ② Turn [F1] to display the Border sub menu.
- ③ Turn [F2] to set On (or Off) for the border using the Border item.
- ④ Turn [F3] to set the width of the border using the Width item.
- ⑤ Turn [F4] to set the amount of soft effect using the Soft item.
 When “On” has been selected as the Border item setting, the ratio of the soft effect to the border width is indicated as the amount of soft effect.
 When only the soft effect is to be added to wipe, select “Off” as the Border item setting.

Setting the border color

- ① On the BKGD menu, turn [F1] to display the BodrCol sub menu.

<Menu display>

BKGD	2	Hue	Sat	Lum	Load↓
BodrCol		0.0	0.0	100.0	White
		0.0	0.0	0.0	Yellow
					Cyan
		359.9	100.0	108.0	Green
					Magenta
					Red
					Blue
					Black

- ② Turn [F2], [F3] and [F4] to adjust the Hue, Sat and Lum of the border color.

■ To call the preset color

Turn [F5] to select the preset color using the Load item, and press the [F5] switch.

The Hue, Sat and Lum values are changed to the preset color values.

- To save the values that were set before calling the preset color, refer to “3-10. Preset memory”.

3. Basic operations

3-3-5. Setting the wipe start position

Any start position can be set for WIPE patterns No.5 and No.11 and for SQ pattern No.5 among the wipe patterns. For WIPE patterns No.5 and No.11, the position is set using the WIPEPos sub menu of the BKGD menu. For SQ pattern No.5, it is set using the SQPos sub menu of the BKGD menu.

- ① Press the [BKGD] button to light its indicator, and display the BKGD menu.
 ☞ Refer to “2-1-5. LCD menu area”.
- ② Turn [F1] to display the WIPEPos sub menu or the SQPos sub menu.

<Menu display>

BKGD	3	X-Pos	Y-Pos		CopyTo↓
WIPEPos		0.00	0.00		
		-100.0	-100.0		
		100.0	100.0		

BKGD	4	X-Pos	Y-Pos		CopyTo↓
SQPos		0.00	0.00		
		-100.0	-100.0		
		100.0	100.0		

- ③ Either operate the positioners or turn [F2] and [F3] to set the wipe start position using the X-Pos item and Y-Pos item.
 These settings can be established only when WIPE or SQ #5 has been selected as the background pattern or key pattern.
- ④ Either operate the fader lever or press the [AUTO] button to check the wipe operation.
 (When, for instance, -50 has been set for X-Pos and -50 for Y-Pos, the following screen (or key) appears from the bottom left and wipe is performed while the screen (or key) moves to the screen center.)

<X-Pos, Y-Pos setting range>

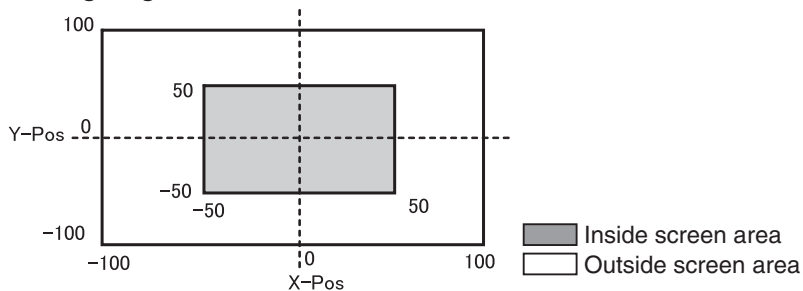

- ⑤ To copy the start position settings, press [F5].
 The copy destination appears under the CopyTo item. (It will not change even if [F5] is turned.)

3. Basic operations

3-3-6. Modifying wipe

Setting the lighting effect

Lighting effects can be added when the following wipe patterns have been selected:

3D1 page: #1, #3, #7, #9

These effects can be set for background transitions and key transitions.

■ For background transitions

① Press the [BKGD] button to light its indicator, and display the BKGD menu.

☞ Refer to “2-1-5. LCD menu area”.

② Turn [F1] to display the Modify sub menu.

<Menu display>

BKGD	5	Light	Trim	4:3Auto
Modify		Off	Off	Off
	On	16:9		On
		4:3		
		4:3Smth		

③ Turn [F2] to select whether the lighting effect at the time a background transition is executed is to be added using the Light item.

On: The lighting effect is added.

Off: The lighting effect is not added.

■ For key transitions

① Press the [KEY] button to light its indicator, and display the KEY menu.

② Turn [F1] to display the Modify sub menu.

<Menu display>

KEY	9	Light		
Modify		Off		
	On			

③ Turn [F2] to select whether the lighting effect at the time a key transition is executed is to be added using the Light item.

On: The lighting effect is added.

Off: The lighting effect is not added.

3. Basic operations

Setting the trimming

When SQ1, SQ2, SL1, SL2, 3D1 or 3D2 has been selected as the wipe pattern, the trimming at the time a background transition is executed can be set.
The “4:3” and “4:3Smth” settings for the Trim item take effect when the HD format has been selected as the system format setting.

- ① On the BKGD menu, turn [F1] to display the Modify sub menu.

<Menu display>

BKGD	5	Light	Trim	4:3Auto
Modify		Off	Off	Off
		On	16:9	On
			4:3	
			4:3Smth	

- ② Turn [F3] to set the trimming operation and transition operation using the Trim item.

16:9 (On): For trimming the edges around the material.

This setting is used when a black border, for instance, can be seen around the material.

When HD has been selected as the system format setting, “16:9” is displayed on the menu, but when SD has been selected as the system format setting, “On” is displayed on the menu.

4:3: For trimming using the 4:3 aspect ratio and releasing the trimming when the transition is completed.

4:3Smth: For trimming using the 4:3 aspect ratio and executing the transition to 16:9 images smoothly.

Off: No trimming

- ③ Turn [F4] to select the setting for automatic trimming (4:3 or 4:3Smth) in accordance with the material using the 4:3Auto item.

Off: All input materials are targeted for automatic trimming.

On: Using the up-converter setting, the input materials for which EC (edge crop) is selected are targeted for automatic trimming.

3. Basic operations

3-4. Key

This operation combines the background image with another image. The key definition can be adjusted, and an edge can be added to the combined image.

Also available as materials besides KEY for combining with the background image are PinP (picture in picture) and DSK (downstream key). The figure below shows their priorities.

<Key, PinP and DSK priorities>

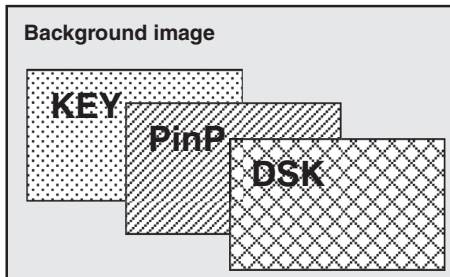

How key combinations work is shown in the figure below.

<How key composition works>

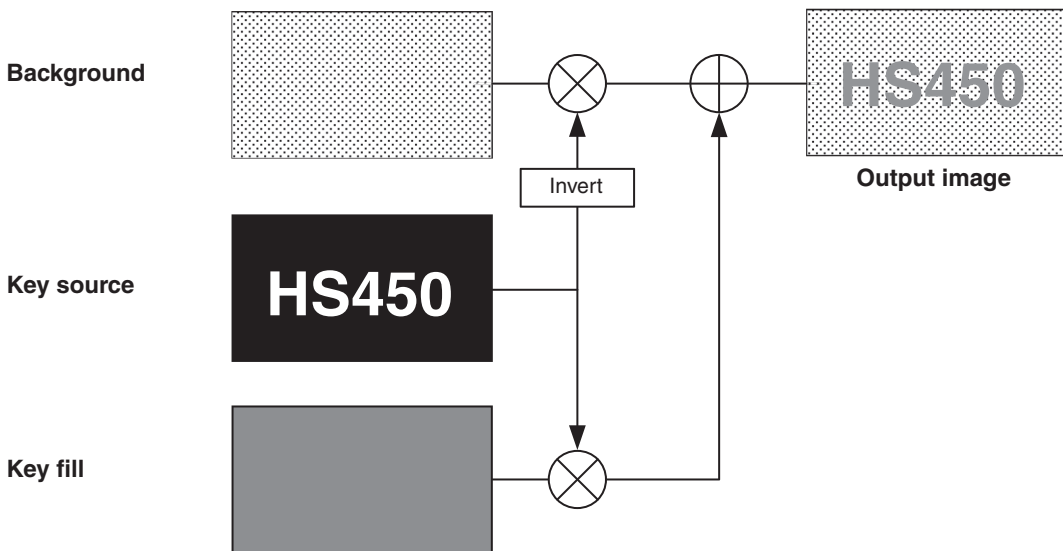

3. Basic operations

3-4-1. Selecting the key type

- ① Press the [KEY] button to light its indicator, and display the KEY menu.
☞ Refer to “2-1-5. LCD menu area”.
- ② Turn [F1] to display the KEY sub menu.
- ③ Turn [F2] to select the Type item.

<Menu display>

KEY	1	Type	LumKey	Fill	PVW
KEY		Linear	ChrmOff	Bus	Auto
		Lum	ChrmOn	Matte	Off
		Chroma			On
		Full			

Lum (luminance key/self key):

This is for creating the key signals from the luminance component or luminance and chroma component of the key fill signal.

Linear (linear key/EXT key):

This is for creating the key signals from the luminance component of the key source signal. It is used when the key source signal and key fill signal are different.

Chroma (chroma key/self key):

This is for creating the key signals using a specific hue of the key fill signal as the reference.

Full (full key/self key):

This is for creating the key signals using the images on the full screen as the key source signals. PinP combinations are possible in conjunction with the flying key. ☞ See “3-4-9. Flying key”.

Since the luminance and chroma keys are operated as self keys, the key fill signals are used as the key source signals. For the full key, the images on the full screen are used as the key source signals. When the luminance key, chroma key or full key has been selected as the key type, the key signals will remain unchanged even when the key source signals are switched.

When using the linear key, use material with a black background and white characters or shape to be combined by the key as the key source signal. Material which is not black and white may not be combined clearly.

Material with a white background and black characters, etc. can be reversed using the key invert function for use.

- ④ When the luminance key has been selected, the chroma component can be included in the generation of the key signals in view of the self key application. (This does not apply to the linear key.)
Turn [F3], and select the setting using the LumKey item.

ChrmOn: In addition to the luminance component, the chroma component is also taken into account in the generation of the key signals.

This is the setting for using a color with a low luminance component for the key signals (such as when defining blue characters).

ChrmOff: The key signals are generated from only the luminance component.

- ⑤ Turn [F4] to select the fill type using the Fill item.

Bus: The bus signal is used for the key fill signal.

Matte: The internal fill matte is used for the key fill signal.

3. Basic operations

3-4-2. Selecting the key material

Selecting the key fill signal

Press the [KEY] button among the AUX bus selector buttons to light its indicator, and press one of the AUX bus crosspoint buttons 1 to 32 to select the key fill signal.

Selecting the key source signal

On the CONFIG menu, set the key source for key fill. This setting is the same for KEY and DSK.

■ Setting with AUX bus crosspoint buttons

- ① Press the [KEY] button (or [DSK 1/2] buttons) of the AUX bus selector buttons to light its indicator, and hold down the AUX bus crosspoint button for the selected key fill signal.

<Menu display>

XPTStats	FILL: INPUT1	SRC↓ INPUT1
	XPT : 1	

- ② Turn the [F5] and select a key source signal (SRC) for the key fill signal (FILL), and press the [F5] switch.

■ Setting in the CONFIG menu

- ① Press the [CONFIG] button to light its indicator, and display the CONFIG menu.
☞ Refer to “2-1-5. LCD menu area”.
- ② Turn [F1] to display the KSAsign sub menu.

<Menu display>

CONFIG11	Fill	Source↓		
KSAsign	-	-		
	IN1~16	IN1~16		
	IN-A1	IN-A1		
	IN-A2	IN-A2		
	IN-B1	IN-B1		
	IN-B2	IN-B2		
	CBGD	CBGD		
	CBAR	CBAR		
	FMEM1~4	FMEM1~4		
	NoAssign			

- ③ Turn [F2] to select the key fill material using the Fill item.
- ④ Turn [F3] to select the key source material using the Source item, and press the [F3] switch.

The luminance and chroma keys are used as self keys so the key fill signal can be used as the key source signal regardless of the menu setting.

3. Basic operations

3-4-3. Key transitions

① Select the transition mode.

Press the [KEY] button in the transition area to light its indicator.
To execute a background transition and key transition at the same time, press the [BKGD] button and [KEY] button together to turn on both indicators.

② Select the transition type.

Use the [MIX] button or [WIPE] button in the transition area to select the key transition mode.
The selected button lights in amber, and the MIX or WIPE status indicator LED depending on the selected mode lights.
If WIPE has been selected, press the [KEY PATT] button in the wipe pattern/memory area to light its indicator, and select the wipe pattern.

③ Set the time of the transition.

On the TIME menu, turn [F1] to display the KEY sub menu.
As with a background transition, set the transition time.

④ Set the wipe direction.

On the KEY menu, turn [F1] to display the Trans sub menu.
Turn [F1] to set Nor (normal) or Rev (reverse) using the OutPatt item.

Nor (normal): The key out pattern moves in the same direction as the key in pattern.

Rev (reverse): The key out pattern moves in the opposite direction from the key in pattern.

<Pattern examples>

	Pattern example 1	Pattern example 2	Pattern example 3 (WIPE5, 10, 11, 12)	Pattern example 4 (SQ5, 10, 12) (3D 1 to 5, 10, 11, 12)
Key in				
Key out (Normal)				
Key out (Reverse)				

: This indicates the areas where keys are combined.

- The operations shown in pattern example 3 are performed for WIPE 5, 10, 11 and 12.
- The operations shown in pattern example 4 are performed for SQ 5, 10 and 12 and for 3D1 5, 10, 11 and 12, and the same operations are performed for normal and reverse.

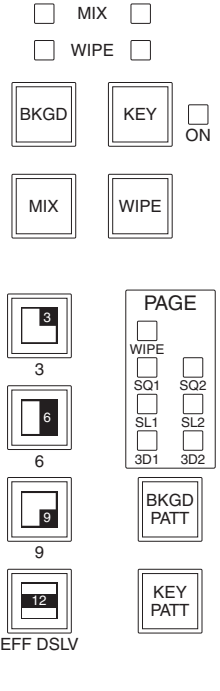

3. Basic operations

⑤ Execute the transition.

Press the [AUTO] button in the transition area to automatically execute the transition at the transition time that has been set.

Alternatively, execute the transition manually by operating the fader lever.

Key auto transition

When the [KEY ON] button in the transition area is pressed, the transition is automatically executed at the transition time that has been set.

During key in, the indicator of the [KEY ON] button blinks in red, and it lights in red when the transition is completed.

If the [KEY ON] button is pressed with the picture completely keyed in, the Key image transition (key out) is executed.

During key out, the indicator of the [KEY ON] button lights in red, and it goes off when the transition is completed.

If the [KEY ON] button is pressed during the transition, the transition direction is reversed.

3-4-4. Key preview

Key preview images can be output to the preview output, and the keys can be adjusted and checked.

① On the KEY menu, turn [F1] to display the KEY sub menu.

② Turn [F5] to set the preview mode using the PVW item.

On: An image with key effects added is output to the preview output.

Off: An image with no key effects added is output to the preview output.

Auto: The preview image of the next transition is output to the preview output.

3. Basic operations

3-4-5. Adjusting the luminance key and linear key

These steps are taken to adjust the luminance key and linear key definition.

- ① Press the [KEY/CKEY] button to light its indicator, and display the KEY menu.
☞ Refer to “2-1-5. LCD menu area”.
- ② Turn [F1] to display the Adjust sub menu.

<Menu display>

KEY	2	Clip	Gain	Density	Invert
Adjust		0.0	100.0	100.0	Off

- ③ Turn [F2], [F3] and [F4] to adjust the key definition.
- ④ Turn [F5] to set key invert.
When On is selected, the key signals to be generated internally are inverted.

Operation	Parameter	Description of setting	Setting range
F2	Clip	Reference level for generating key signals	0.0 to 108.0
F3	Gain	Key amplitude	0.0 to 200.0
F4	Density	Key density	0.0 to 100.0
F5	Invert	Key signal inversion	On, Off

3. Basic operations

3-4-6. Adjusting the chroma key

Sampling is executed for the selected key materials to adjust those aspects of the key that are to be compensated.

Step 1

■ To execute the sampling automatically

<Menu display>

- ① Press the [KEY/CKEY] button to light its indicator, and display the CHR KEY menu.
 ☞ Refer to “2-1-5. LCD menu area”.
- ② Turn [F1] to display the AutoCmp sub menu.
- ③ Press [F2] to execute the sampling automatically.
 To undo what has been sampled, press [F5].

CHRKEY 1	AutCmp↓			RESET↓
AutoCmp				

■ To execute the sampling manually

<Menu display>

- ① Press the [KEY/CKEY] button to light its indicator, and display the CHR KEY menu.
 ☞ Refer to “2-1-5. LCD menu area”.
- ② Turn [F1] to display the Sample1 sub menu.
- ③ Turn [F2] to select “Cmpsit” using the View item.

CHRKEY 2	View	Mode		UNDO↓
Sample1	Cmpsit	SelBG		
	Matte	Cln.BG		
	Proc.FG	Cln.FG		
	FG	Spl.Spg		

- ④ Turn [F3] to select “SelBG” using the Mode item.
 - Cmpsit:** Composite image that combines the background image and key
 - Matte:** Matte image
 - Proc.FG:** Process foreground image
 - FG:** Foreground image
- ④ Turn [F3] to select “SelBG” using the Mode item.
 - SelBG:** A color for the background of the foreground image is specified.
Normally, either a blue or green background is specified.
 - Cln.BG:** The noise in the background image is removed.
 - Cln.FG:** The noise in the foreground image is removed.
 - Spl.Spg:** The noise remaining in the detailed areas is removed.
- ⑤ Use the positioner to move the position of the sample marker.
 To change the size of the sample marker, turn the rotary encoder [Z].
- ⑥ If the sample area that has been set is acceptable, press the rotary encoder [Z].
 The area that has been set is now sampled.
- ⑦ To return to the pre-sampling status after sampling has been executed, press [F5].
 The number of operations that can be undone is one only.

3. Basic operations

Step 2

The objective of this step is to remove the noise in the background image. The noise is removed by carrying out this step several times.

- ① On the CHR KEY menu, turn [F1] to display the Sample1 sub menu.

<Menu display>

CHRKEY 2	View	Mode		UNDO↓
Sample1	Matte	Cln.BG		

- ② Turn [F2] to select “Matte” using the View item.
- ③ Turn [F3] to select “Cln.BG” using the Mode item.
- ④ Using the positioner, move the position of the sample marker to the position of the noise (white dots) in the background image.
To change the size of the sample marker, turn the rotary encoder [Z].
- ⑤ If the sample area that has been set is acceptable, press the rotary encoder [Z].
The noise in the area that has been set is now removed.
- ⑥ To return to the pre-sampling status after sampling has been executed, press [F5].
The number of operations that can be undone is one only.



Before the noise is removed



After the noise is removed

3. Basic operations

Step 3

The objective of this step is to remove the noise in the foreground image. The noise is removed by carrying out this step several times.

- ① Turn [F2] to select “Matte” using the View item.

<Menu display>

CHRKEY 2	View	Mode		UNDO↓
Sample1	Matte	Cln.FG		

- ② Turn [F3] to select “Cln.FG” using the Mode item.
- ③ Using the positioner, move the position of the sample marker to the position of the noise (white dots) in the foreground image.
To change the size of the sample marker, turn the rotary encoder [Z].
- ④ If the sample area that has been set is acceptable, press the rotary encoder [Z].
The noise in the area that has been set is now removed.
- ⑤ To return to the pre-sampling status after sampling has been executed, press [F5].
The number of operations that can be undone is one only.

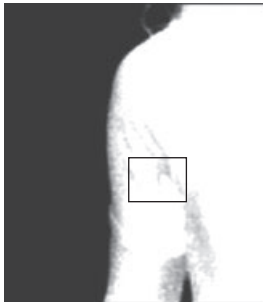

Before the noise is removed



After the noise is removed

3. Basic operations

Step 4

After steps 1 to 3 have been carried out, noise will still remain in the detail areas such as the subject's hair as shown in the image on the right.

If there are many areas with noise, the noise is removed by carrying out this step several times.

If there are few areas with noise, adjust the noise using the Spill(+) item and Spill(-) item of the Sample2 sub menu.



- ① Turn [F2] to select "Cmpsit" using the View item.
- ② Turn [F3] to select "Spl.Spg" using the Mode item.

<Menu display>

CHRKEY 2	View	Mode		UNDO↓
Sample1	Cmpsit	Spl.Spg		

- ③ Using the positioner, move the position of the sample marker to the position of the remaining noise.
To change the size of the sample marker, turn the rotary encoder [Z].
 - ④ If the sample area that has been set is acceptable, press the rotary encoder [Z].
The noise in the area that has been set is now removed, and the colors become more natural.
 - ⑤ To return to the pre-sampling status after sampling has been executed, press [F5].
The number of operations that can be undone is one only.
- Execute sampling in both the light and dark areas as the sample area.
 - If the noise in the foreground image is not completely removed by carrying out the steps above, proceed with the FineTun sub menu operation.

3. Basic operations

Step 5

The objective of this step is to finely adjust the image by adjusting the noise and transparency, for example.

- ① On the CHR KEY menu, turn [F1] to display the Sample2 sub menu.

<Menu display>

CHRKEY 3	View	Mode		UNDO↓
Sample2	Cmpsit	Spill-		
	Matte	Spill+		
	Proc.FG	Matte-		
	FG	Matte+		
		Detail-		
		Detail+		
		MatSpng		
		MkFGTrn		
		RstrDt1		

- ② Turn [F2] to select the image to be adjusted using the View item.
 - Cmpsit:** Composite image that combines the background image and key
 - Matte:** Matte image
 - Proc.FG:** Process foreground image
 - FG:** Foreground image
- ③ Turn [F3] to select the adjustment function using the Mode item.
For details on the items, refer to the following pages.
- ④ Using the positioner, move the position of the sample marker to the position to be sampled.
To change the size of the sample marker, turn the rotary encoder [Z].
- ⑤ If the sample area that has been set is acceptable, press the rotary encoder [Z].
The area that has been set is now sampled.
- ⑥ To return to the pre-sampling status after sampling has been executed, press [F5].
The number of operations that can be undone is one only.

3. Basic operations

[Spill-] [Spill+]

In these modes, the noise in the foreground image can be removed or restored step by step through repeated sampling.



[+]

← Spill →

[-]

[Matte-] [Matte+]

In these modes, the matte information is adjusted.

If, for instance, the area of shadow in the foreground image is to be made lighter, use [Matte-] to adjust.

Conversely, to make it darker, use [Matte+].

Transparent images such as images of smoke or water can be made to stand out more.



[-]

← Matte →

[+]

3. Basic operations

[Detail-] [Detail+]

In these modes, the noise in the background image can be removed step by step.

This is a useful way of adjusting images lost by other sampling operations to adjust the texture or transparency of images.



[-]



[+]

← Detail →

[MatSpng]

In this mode, the semi-transparent parts of the subject in a foreground image are selected and made matte (non-transparent). Unlike [Cln.FG] on the Sample1 sub menu, the color information is not changed in the process.

With [Cln.FG], the colors of the selected parts are restored to their original colors but, with [MatSpng], only the semi-transparent keys are made matte (non-transparent) while the colors remain unchanged and the original colors are not restored.

[MkFGTrn]

In this mode, the transparency of areas with a low transparency in the foreground image is increased.

This is useful when, for instance, areas covered with dark smoke or clouds in a foreground image are to be made semi-transparent.

[RstrDtl]

In this mode, the transparency of areas with a high transparency in the background image is reduced.

This is useful when, for instance, restoring the details of an image (such as an image with a subject who has loose hair or an image with smoke), which have been lost as a result of a [ClnBG] or other such operation on the Sample1 sub menu, to what they were in the original image.

3. Basic operations

[FineTun]

In this mode, detailed images can be adjusted.

- ① On the CHR KEY menu, turn [F1] to display the FineTun sub menu.

<Menu display>

CHRKEY 4	View	Spill	Trans	Detail
FineTun	Cmpsit	0	0	0

- ② Turn [F2] to select [Cmpsit] using the View item.
- ③ Turn [F3] to remove or restore the noise using the Spill item.
When it is turned clockwise, a large amount of noise is removed from the foreground image, and the image colors increasingly approach the complementary color (opposite color) of the blue screen.
When it is turned counterclockwise, the image colors approach the colors of the original foreground image.
- ④ By turning [F4] clockwise, the matte of the colors closely resembling the colors of the foreground image can be adjusted using the Trans item.
This is useful when, for instance, making the parts covered by dark smoke, clouds or other such objects in the foreground image semi-transparent.
- ⑤ By turning [F5] clockwise, the matte information for the colors closely resembling the colors of the background image can be adjusted using the Detail item.
This is useful when, for instance, restoring the details of an image (such as an image with a subject who has loose hair or an image with smoke), which have been lost in the foreground image as a result of sampling, to what they were in the original image.

3. Basic operations

3-4-7. Key decorations

A border, shadow or other edge can be added to the key.

Setting the key edge

① Press the [KEY] button to light its indicator and display the KEY menu.

☞ Refer to “2-1-5. LCD menu area”.

② Turn [F1] to display the Edge sub menu.

③ Turn [F2] to select the edge type.

- Off:** An edge is not added.
- Border:** A border is added around the entire edge.
- Drop:** A diagonal border is added.
- Shadow:** A shadow is added.
- Outline:** An outline (only a border with no fill) is added.



④ Turn [F3] to set the edge width.

⑤ Turn [F4] to set the direction (in 45-degree increments) in which “Drop” and “Shadow” will be added.

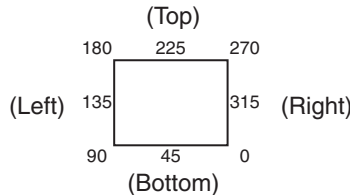

<Menu display>

KEY	4	Type	Width	Dir ec
Edge		Off	2	0
		Border	0~4	45
		Drop		90
		Shadow		135
		Outline		180
				225
				270
				315

Setting the edge color

① On the KEY menu, turn [F1] to display the EdgeCol sub menu.

② Turn [F2], [F3] and [F4] to adjust the Hue, Sat and Lum of the edge color.

■ To call the preset color

Turn [F5] to select the preset color using the Load item, and press the [F5] switch.

The Hue, Sat and Lum values are changed to the preset color values.

- To save the values that were set before calling the preset color, refer to “3-10. Memory”.

<Menu display>

KEY	5	Hue	Sat	Lum	Load↓
EdgeCol		0.0	0.0	100.0	Black
		0.0	0.0	0.0	White
					Yellow
		359.9	100.0	108.0	Cyan
					Green
					Magenta
					Red
					Blue

3. Basic operations

3-4-8. Masking the key signals

These steps are taken to mask the key signals using the mask signal of the box pattern.

- ① Press the [KEY] button to light its indicator and display the KEY menu.
☞ Refer to “2-1-5. LCD menu area”.
- ② Turn [F1] to display the Mask sub menu.

<Menu display>

KEY	10	Mask	Invert		
Mask		Off	Off		
		Manual	On		
		4:3			

- ③ Turn [F2], and select the masking method using the Mask item.
 - Off:** The key signals are not masked.
 - Manual:** The area that is set using the MaskAdj sub menu is masked.
 - 4:3:** The signals are masked to the 4:3 aspect ratio.
- ④ Turn [F3] to set whether to invert the mask signal using the Invert item.
 - On:** The mask signal is inverted.
 - Off:** The mask signal is not inverted.
- ⑤ Turn [F1] to display the MaskAdj sub menu.

<Menu display>

KEY	11	Left	Top	Bottom	Right
MaskAdj		-25.00	25.00	-25.00	25.00

- ⑥ Turn [F2] to [F5] to set the area to be masked.

Operation	Parameter	Description of setting	Setting range	Initial value
F2	Left	Key left position	-50.00 to 50.00	-25.00
F3	Top	Key top position	-50.00 to 50.00	25.00
F4	Bottom	Key bottom position	-50.00 to 50.00	-25.00
F5	Right	Key right position	-50.00 to 50.00	25.00

The Left setting cannot exceed the Right setting (and vice versa) and, similarly, the Top setting cannot exceed the Bottom setting (and vice versa).

<Key mask setting> (figure shows the default values)

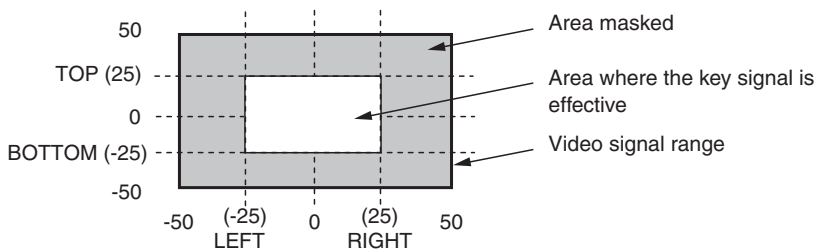

3. Basic operations

3-4-9. Flying key

Using DVE effects, this key enables the key signals that have been input to be moved, expanded or contracted. In order for the flying key to take effect, select SL #5 as the key transition.

When the key transition is executed, the keys are combined by the key signals set using the flying key menu. (The transition effect is fixed at MIX.)

Since the flying key uses DVE effects, the image is delayed by one frame.

- ① Press the [KEY] button to light its indicator and display the KEY menu.
☞ Refer to “2-1-5. LCD menu area”.
- ② Turn [F1] to display the FlyKEY sub menu.
(It is also possible to display the FlyKEY sub menu directly without displaying the KEY menu in step ① by double-clicking the SL No.5 button.)

<Menu display>

KEY	8	X-Pos	Y-Pos	Size	
FlyKEY		0.00	0.00	100.0	
		-100.00	-100.00	0.0	
		100.00	100.00	400.0	

- ③ Turn [F2] to set the X coordinate of the key signal using the X-Pos item.
- ④ Turn [F3] to set the Y coordinate of the key signal using the Y-Pos item.
- ⑤ Turn [F4] to set the key signal change size (max. 400: 400 %) using the Size item.

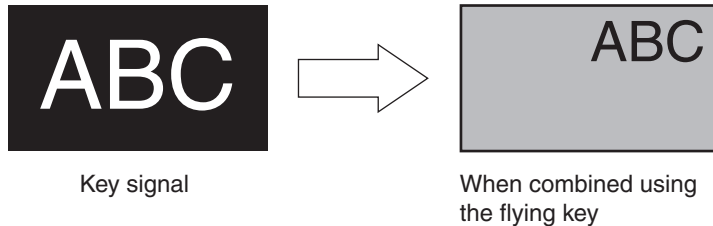

In order to add the edge of the key before the DVE effect, the thickness of the edge is also changed when the size is changed.

PinP combinations using the flying key

When “Full” is selected using the Type item in “3-4-1. Selecting the key type”, PinP combinations can be performed using the flying key. (At this point in time, the Clip item and Gain item cannot be set on the Adjust sub menu.)

With the full key, the image on the full screen serves as the key source signal so an edge will not be added unless a further step is taken.

To add an edge, mask the key signals so that the key source signals are made smaller than the entire screen. For details on masking, refer to “3-4-8. Masking the key signals”.

3. Basic operations

3-5. PinP (picture in picture)

Another image can be combined with the background image.
 This unit supports two PinP channels.

3-5-1. Selecting the PinP channel and material

Press the [PinP 1/2] button among the AUX bus selector buttons.
 When the button is lighted in amber, the PinP1 sub menu is displayed on the LCD, and the state in which the PinP1 materials are selected is now established for the AUX bus crosspoint buttons.
 When the button is lighted in green, the PinP2 sub menu is displayed on the LCD, and the state in which the PinP2 materials are selected is now established for the AUX bus crosspoint buttons.

The selected AUX bus crosspoint button lights in amber. (It will light in red if the selected signal is a PGM output signal.)

<Menu display>

PinP1	1	Shape	CrclAsp	Density	PVW
PinP1		Square	0.0	100.0	Off
		Circle	0.0	0.0	On
			100.0	100.0	

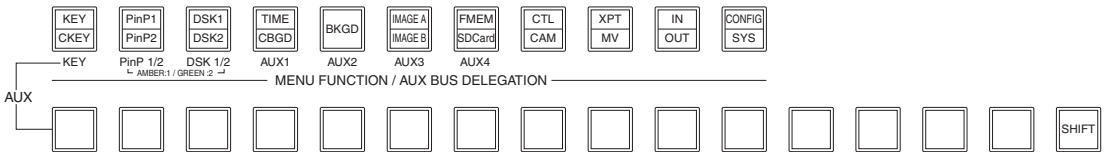

3. Basic operations

3-5-2. Selecting Shape

Square or Circle can be selected as the shape used for combining PinP1 images.
PinP2 images are fixed as Square.

- Press the [PinP1/PinP2] button to light its indicator and display the PinP1 menu.
Refer to “2-1-5. LCD menu area”.

<Menu display>

PinP1	1	Shape	CrclAsp	Density	PVW
PinP1		Square	0.0	100.0	Off
		Circle	0.0	0.0	On
			100.0	100.0	

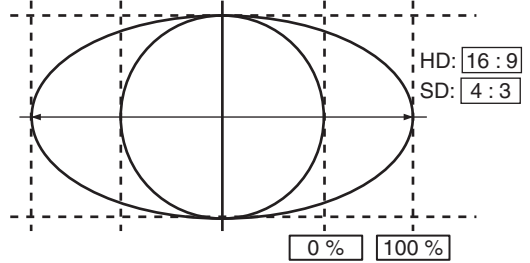

- Turn [F2] and, using the Shape item, select the shape used for combining images.
When Circle has been selected using the Shape item, turn [F3] to change the aspect ratio of the circle using the CrclAsp item.
When Square has been selected using the Shape item, “—” is displayed for the CrclAsp item.
- Turn [F4] to adjust the transmissivity (darkness) applying when the images are combined using the Density item.

3-5-3. PinP preview

Select whether to output the PinP1 and PinP2 preview images to the preview output.
On the PinP1 menu (or PinP2 menu), turn [F5] to set the PVW item.
Settings for the PVW item are the same for both PinP1 and PinP2.

<Menu display>

PinP1	1	Shape	CrclAsp	Density	PVW
PinP1		Square	0.0	100.0	Off
		Circle	0.0	0.0	On
			100.0	100.0	

- On:** An image with the PinP1 and PinP2 effect added is output to the preview output.
- Off:** An image without the PinP1 and PinP2 effect added is output to the preview output.

The PVW On and Off settings can be allocated to the user buttons.
Refer to “5-3-1. Setting the user buttons”.

3. Basic operations

3-5-4. PinP transitions

- ① Set the transition time.
On the TIME menu, turn [F1] to display the PinP1 sub menu (or PinP2 sub menu).
As with background transitions, set the transition time.
☞ Refer to “3-1-6. Auto transition”.
- ② When the [PinP1 ON] button (or [PinP2 ON] button) in the transition area is pressed, the PinP1 image (or PinP2 image) transitions (fades in) for the length of the transition time that has been set.
During fade-in, the [PinP1 ON] button (or [PinP2 ON] button) blinks in red, and when the transition is completed, it lights in red.
When the [PinP1 ON] button (or [PinP2 ON] button) is pressed after fade-in is completed, the PinP1 image (or PinP2 image) transitions (fades out).
During fade-out, the [PinP1 ON] button (or [PinP2 ON] button) lights in red, and when the transition is completed, it goes off.
If the [PinP1 ON] button (or [PinP2 ON] button) is pressed at any point during a transition, the direction of the transition is reversed.

3-5-5. PinP adjustments

Adjusting the PinP position and size

While the PinP menu is selected, adjust the X and Y coordinates using the positioner in the positioner area, and adjust the size using the rotary encoder [Z]. Alternatively, the settings can be performed on the menus.

- ① Press the [PinP1] button (or [PinP2] button) to light its indicator and display the PinP1 menu (or PinP2 menu).
☞ Refer to “2-1-5. LCD menu area”.
- ② Turn [F1] to display the Position sub menu.
- ③ Either operate the positioner and the rotary encoder [Z] or turn [F2], [F3] and [F4] to set the X and Y coordinates and the size using the X-Pos, Y-Pos and Size items.

<Menu display>

PinP1 4	X-Pos	Y-Pos	Size	
Position	0.00	0.00	25.00	
	-50.00	-50.00	0.00	
	50.00	50.00	100.00	

3. Basic operations

Adjusting the rotation angle

- ① On the PinP1 menu (or PinP2 menu), turn [F1] to display the Rotation sub menu.
- ② Either operate the positioner and rotary encoder [Z] or turn [F2], [F3] and [F4] to set the X rotation, Y rotation and Z rotation.

<Menu display>

PinP1 5	X	Y	Z	
Rotation	0	0	0	
	-360	-360	-360	
	+360	+360	+360	

Select the dot by dot mode

When the system is set to the HD mode and an SD format image is to be used for the PinP material, the images can be combined in the dot by dot mode (actual-size images). In this mode, the SD format image will not be up-converted so image deterioration can be prevented. Furthermore, since the images are handled in their actual size, the PinP size is fixed.

- ① Press the [INPUT] button to light its indicator and display the INPUT menu.
☞ Refer to “2-1-5. LCD menu area”.
- ② Turn [F1] to display the INPUT XX sub menu.
 (X: IN1 to IN16, A1, A2, B1, B2)
 Select the PinP material input for X.
- ③ Turn [F2] to display the third menu of FS.

<Menu display>

INPUT XX	FS	FS	Mode↓	CC
	1/13	On	*Normal	Off
		Off	DbyD	On
			UC	
			Auto	

- ④ Turn [F4] to select DbyD using the Mode item, and press the [F4] switch to enter the selection.

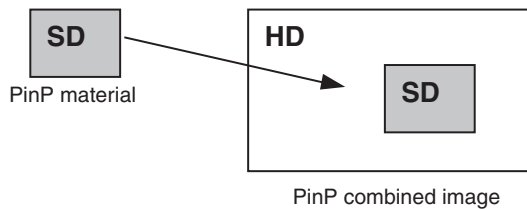

3. Basic operations

3-5-6. Linking PinP1 and PinP2

The PinP1 and PinP2 images perform a symmetrical operation for the axis whose coordinates and rotation angle have been set.

The image serving as the reference is the PinP image of the menu being operated.

- ① On the PinP1 menu (or PinP2 menu), turn [F1] to display the Sync sub menu.

<Menu display>

PinP1	8	Prior	Sym		
Sync		lover2	Off		
		2over1	X		
			Y		
			Center		

Setting the priority

- ② Turn [F2] to select, using the Prior item, to set the positional relationship when the PinP1 and PinP2 images overlap.

1over2: The PinP1 image is placed over the PinP2 image

2over1: The PinP2 image is placed over the PinP1 image

Linking PinP1 and PinP2

- ③ Turn [F3] to set the position that will serve as the reference. The image serving as the reference is the PinP image of the menu being operated.

When "X" has been selected as the Synm setting

The coordinates and rotation angle are made symmetrical to the X axis.

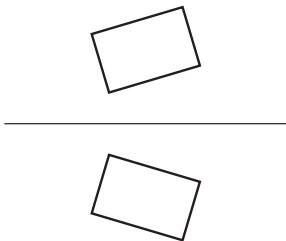

When "Y" has been selected as the Synm setting

The coordinates and rotation angle are made symmetrical to the Y axis.

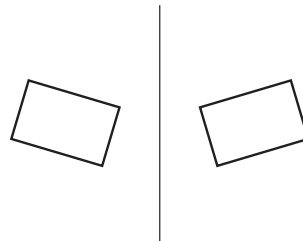

When "Center" has been selected as the Synm setting

The coordinates and rotation angle are made symmetrical to the center.

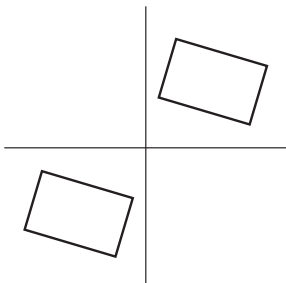

3. Basic operations

3-5-7. PinP decorations

A border or soft effect can be added to PinP.

- Press the [PinP1] button (or [PinP2] button) to light its indicator and display the PinP1 menu (or PinP2 menu).
 Refer to “2-1-5. LCD menu area”.

- Turn [F1] to display the Border sub menu.

<Menu display>

PinP1	2	Border	Width	Soft	Mode
Border		Off	5.0	0.0	Fix
		On	0.1	0.0	Var
			100.0	100.0	

- Turn [F2] to set On (or Off) for the border using the Border item.
- Turn [F3] to set the width of the border using the Width item.
- Turn [F4] to set the amount of soft effect using the Soft item. The soft effect is OFF if 0.0 is set.
 When “On” has been selected as the Border item setting, the ratio of the soft effect to the border width is indicated as the amount of soft effect.
 When only the soft effect is to be added to PinP, select “Off” as the Border item setting.
- Turn [F5] to set the change in the border width using the Mode Item.

Fix: The border width is kept constant.

Var (Variable): The border width changes to suit the PinP size.

Setting the border color

- On the PinP1 menu (or PinP2 menu), turn [F1] to display the BodrCol sub menu.

<Menu display>

PinP1	3	Hue	Sat	Lum	Load↓
BodrCol		0.0	0.0	100.0	White
		0.0	0.0	0.0	Yellow
					Cyan
		359.9	100.0	108.0	Green
					Magenta
					Red
					Blue
					Black

- Turn [F2], [F3] and [F4] to adjust the Hue, Sat and Lum of the border color.

■ To call the preset color

Turn [F5] to select the preset color using the Load item, and press the [F5] switch.

The Hue, Sat and Lum values are changed to the preset color values.

- To save the values that were set before calling the preset color, refer to “3-10. Memory”.

3. Basic operations

3-5-8. Trimming settings

① Press the [PinP1] button (or [PinP2] button) to light its indicator and display the PinP1 menu (or PinP2 menu).

☞ Refer to “2-1-5. LCD menu area”.

② Turn [F1] to display the Trim sub menu.

<Menu display>

PinP1 6	Trim	Manual		
Trim	Off	Free		

Manual	Pair
4:3	

③ Turn [F2] to select the trimming type using the Trim item.

Off: No trimming

4:3: Automatic trimming so that the aspect ratio is 4:3

Manual: Trimming using the value set on the TrimAdj sub menu

④ Turn [F3] to select the operation to be performed during the manual setting using the Manual item.

Free: The Left, Right, Top and Bottom parameters change independently.

However, the Left setting cannot exceed the Right setting (and vice versa) and, similarly, the Top setting cannot exceed the Bottom setting (and vice versa).

Pair: The settings are changed in such a way that the Left and Right trimming amounts and the Top and Bottom trimming amount are the same. (This makes for a top-bottom and left-right symmetry.)

⑤ Turn [F1] to display the TrimAdj sub menu, and turn [F2], [F3], [F4] and [F5] to set the trimming values.

Operation	Parameter	Description of setting	Setting range	Initial value
F2	Left	Trimming value at left	-50.00 to 50.00	-40.00
F3	Top	Trimming value at top	-50.00 to 50.00	40.00
F4	Bottom	Trimming value at bottom	-50.00 to 50.00	-40.00
F5	Right	Trimming value at right	-50.00 to 50.00	40.00

<Trimming settings> (figure shows the default values)

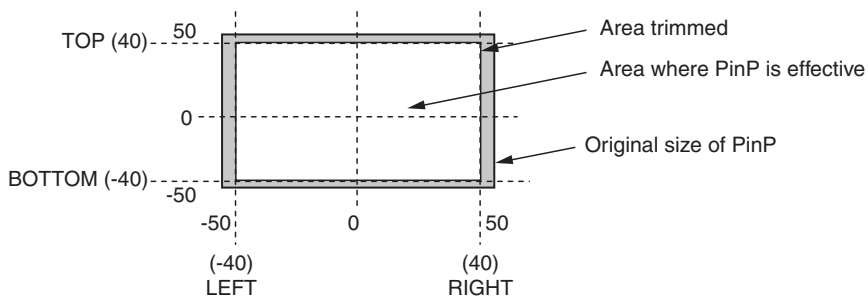

3. Basic operations

3-6. DSK (downstream key)

Characters or other images can be combined with the background image.
This unit supports two DSK channels.

3-6-1. Selecting the DSK type

- ① Press the [DSK1] button (or [DSK2] button) to light its indicator and display the DSK1 menu (or DSK2 menu).

☞ Refer to “2-1-5. LCD menu area”.

- ② Turn [F1] to display the DSK1 sub menu (or DSK2 sub menu).

<Menu display>

DSK1	1	Type	LumKey	Fill	PVW
DSK1		Linear	ChrmOff	Bus	Off
		Lum	ChrmOn	Matte	On

- ③ Turn [F2] to select the Type item.

Lum (luminance key/self key):

This is for creating the key signals from the luminance component of the key fill signal.

Linear (linear key/EXT key):

This is for creating the key signals from the luminance component of the key source signal.

It is used when the key source signal and key fill signal are different.

Since the luminance key is operated as a self key, the key fill signals are used as the key source signals. When the luminance key has been selected as the downstream key type, the key signals will remain unchanged even when the key source signals are switched.

When using the linear key, use material with a black background and white characters or shape to be combined by the key as the key source signal.

Material which is not black and white may not be combined clearly.

Material with a white background and black characters, etc. can be reversed using the key invert function for use.

- ④ When the luminance key has been selected, the chroma components can be contained in the key signals generated in view of the fact that it is used as a self key. (This is not applied to the linear key.) Turn [F3] to select the setting using the LumKey item.

ChrmOn: In addition to the luminance components, the chroma components are also factored in when generating the key signals.

Use this setting if colors with low luminance components are used for the key signals (when, for instance, blue characters are to be removed).

ChrmOff: The key signals are generated only from the luminance components.

- ⑤ Turn [F4] to select the fill type using the Fill item.

Bus: The bus signal is used for the key fill signal.

Matte: The internal fill matte is used for the key fill signal.

3. Basic operations

Setting the fill matte color

- ① On the DSK1 menu (or DSK2 menu), turn [F1] to display the FillMatt sub menu.

<Menu display>

DSK1	3	Hue	Sat	Lum	Load↓
FillMatt		0.0	0.0	100.0	White
		0.0	0.0	0.0	Yellow
					Cyan
		359.9	100.0	108.0	Green
					Magenta
					Red
					Blue
					Black

- ② Turn [F2], [F3] and [F4] to adjust the Hue, Sat and Lum of the fill matte.

■ To call the preset color

Turn [F5] to select the preset color using the Load item, and press the [F5] switch. The Hue, Sat and Lum values are changed to the preset color values.

- To save the values that were set before calling the preset color, refer to “3-10. Memory”.

3. Basic operations

3-6-2. Selecting the DSK channel and DSK fill material

When the [DSK 1/2] button among the AUX bus selector buttons is pressed and it has lighted in amber, DSK1 is displayed as the menu.

The state in which the DSK1 fill material is selected is now established for the AUX bus crosspoint buttons. If the button has lighted in green, DSK2 is displayed as the menu, and the state in which the DSK2 fill material is selected is now established for the AUX bus crosspoint buttons.

The selected AUX bus crosspoint button lights in amber. (It will light in red if the selected signal is a PGM output signal.)

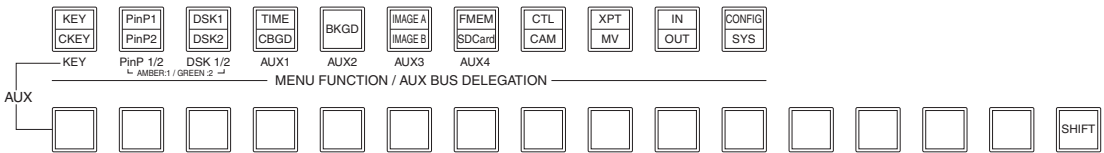

Selecting the DSK source signal

As with the selection of the KEY source signal, set the DSK source for the DSK fill. This setting is the same for KEY and DSK.

■ Setting with AUX bus crosspoint buttons

- Press the [DSK 1/2] button (or [KEY] buttons) of the AUX bus selector buttons to light its indicator, and hold down the AUX bus crosspoint button for the selected key fill signal.

<Menu display>

XPTStats	FILL: INPUT1	SRC↓ INPUT1
	XPT : 1	

- Turn the [F5] and select a DSK source signal (SRC) for the DSK fill signal (FILL), and press the [F5] switch.

■ Setting in the CONFIG menu

- Press the [CONFIG] button to light its indicator, and display the CONFIG menu.
Refer to “2-1-5. LCD menu area”.
- Turn [F1] to display the KSAsign sub menu.
- Turn [F2] to select the DSK fill material using the Fill item.
- Turn [F3] to select the DSK source material using the Source item, and press the [F3] switch.

The luminance and chroma keys are used as self keys so the DSK fill signal can be used as the DSK source signal regardless of the menu setting.

<Menu display>

CONFIG11	Fill	Source↓		
KSAsign	-	-		
	IN1~16	IN1~16		
	IN-A1	IN-A1		
	IN-A2	IN-A2		
	IN-B1	IN-B1		
	IN-B2	IN-B2		
	CBGD	CBGD		
	CBAR	CBAR		
	FMEM1~4	FMEM1~4		
	NoAsign			

3. Basic operations

3-6-3. DSK transitions

- ① Set the transition time.
On the TIME menu, turn [F1] to display the DSK1 sub menu (or DSK2 sub menu).
As with background transitions, set the transition time.
☞ Refer to “3-1-6. Auto transition”.
- ② When the [DSK1 ON] button (or [DSK2 ON] button) in the transition area is pressed, the DSK1 image (or DSK2 image) is combined (fades in) for the length of the transition time that has been set.

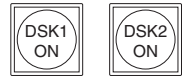

During fade-in, the [DSK1 ON] button (or [DSK2 ON] button) blinks in red, and when the transition is completed, it lights in red.
When the [DSK1 ON] button (or [DSK2 ON] button) is pressed after fade-in is completed, the DSK1 image (or DSK2 image) transitions (fades out).
During fade-out, the [DSK1 ON] button (or [DSK2 ON] button) lights in red, and when the transition (fade-out) is completed, it goes off.
If the [DSK1 ON] button (or [DSK2 ON] button) is pressed at any point during a transition, the direction of the transition is reversed.

3-6-4. DSK preview

Select whether to output the DSK1 (or DSK2) preview image to the preview output.

- ① Press the [DSK1] button (or [DSK2] button) to light its indicator and display the DSK1 menu (or DSK2 menu).
☞ Refer to “2-1-5. LCD menu area”.

<Menu display>

DSK1	1	Type	LumKey	Fill	PVW
DSK1		Linear	ChrmOff	Bus	Off
		Lum	ChrmOn	Matte	On

- ② Turn [F5] to set the PVW item.
On: An image with the DSK1 (or DSK2) effect added is output to the preview output.
Off: An image without the DSK1 (or DSK2) effect added is output to the preview output.

PVW On and Off can be allocated to the user buttons. ☞ See “5-3-1. Setting the user buttons”.

3. Basic operations

3-6-5. DSK adjustments

The DSK definition can be adjusted.

- ① Press the [DSK1] button (or [DSK2] button) to light its indicator and display the DSK1 menu (or DSK2 menu).

☞ Refer to “2-1-5. LCD menu area”.

- ② Turn [F1] to display the Adjust sub menu.

<Menu display>

DSK1	2	Clip	Gain	Density	Invert
Adjust		0.0	100.0	100.0	Off

- ③ Turn [F2], [F3] and [F4] to adjust the DSK (downstream key) definition.
- ④ Turn [F5] to set key invert.

If On is set, the key signals generated internally are inverted.

Operation	Parameter	Description of setting	Setting range
F2	Clip	Reference level for generating key signals	0.0 to 108.0
F3	Gain	Key amplitude	0.0 to 200.0
F4	Density	Key density	0.0 to 100.0
F5	Invert	Key signal inversion	On, Off

3. Basic operations

3-6-6. DSK decorations

A border, shadow or other type of edge can be added to DSK.

Setting the edge

- Press the [DSK1] button (or [DSK2] button) to light its indicator and display the DSK1 menu (or DSK2 menu).

☞ Refer to “2-1-5. LCD menu area”.

- Turn [F1] to display the Edge sub menu.
- Turn [F2] to select the edge type.

- Off:** An edge is not added.
- Border:** A border is added around the entire edge.
- Drop:** A diagonal border is added.
- Shadow:** A shadow is added.
- Outline:** An outline (only a border with no fill) is added.

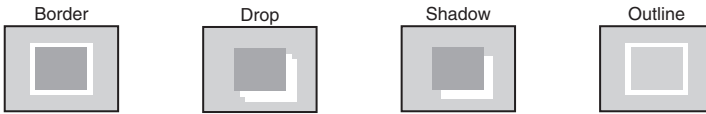

- Turn [F3] to set the edge width.
- Turn [F4] to set the direction (in 45-degree increments) in which “Drop” and “Shadow” will be added.

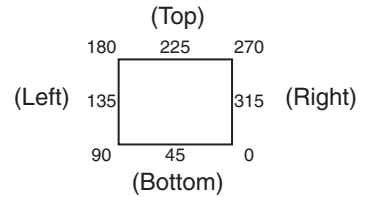

<Menu display>

DSK1	4	Type	Width	Dirac	
Edge		Off	2	0	
Border		0~4		45	
Drop				90	
Shadow				135	
Outline				180	
				225	
				270	
				315	

Setting the edge color

- On the DSK1 menu (or DSK2 menu), turn [F1] to display the EdgeCol sub menu.
- Turn [F2], [F3] and [F4] to adjust the Hue, Sat and Lum of the edge color.

■ To call the preset color

Turn [F5] to select the preset color using the Load item, and press the [F5] switch. The Hue, Sat and Lum values are changed to the preset color values.

- To save the values that were set before calling the preset color, refer to “3-10. Memory”.

<Menu display>

DSK1	5	Hue	Sat	Lum	Load↓
EdgeCo1		0.0	0.0	0.0	Black
		0.0	0.0	0.0	White
					Yellow
		359.9	100.0	108.0	Cyan
					Green
					Magenta
					Red
					Blue

3. Basic operations

3-6-7. Masking the DSK signals

These steps are taken to mask the DSK signals using the mask signal of the box pattern.

- Press the [DSK1] button (or [DSK2] button) to light its indicator and display the DSK1 menu (or DSK2 menu).
☞ Refer to “2-1-5. LCD menu area”.

- Turn [F1] to display the Mask sub menu.

<Menu display>

DSK1	6	Mask	Invert		
Mask		Off	Off		
		Manual	On		
		4:3			

- Turn [F2], and select the masking method using the Mask item.

Off: The DSK signals are not masked.

Manual: The area that is set using the MaskAdj sub menu is masked.

4:3: The signals are masked to the 4:3 aspect ratio.

- Turn [F3] to set whether to invert the mask signal using the Invert item.

On: The mask signal is inverted.

Off: The mask signal is not inverted.

- Turn [F1] to display the MaskAdj sub menu.

<Menu display>

DSK1	7	Left	Top	Bottom	Right
MaskAdj		-25.00	25.00	-25.00	25.00

- Turn [F2] to [F5] to set the area to be masked.

Operation	Parameter	Description of setting	Setting range	Initial value
F2	Left	DSK left position	-50.00 to 50.00	-25.00
F3	Top	DSK top position	-50.00 to 50.00	25.00
F4	Bottom	DSK bottom position	-50.00 to 50.00	-25.00
F5	Right	DSK right position	-50.00 to 50.00	25.00

The Left setting cannot exceed the Right setting (and vice versa) and, similarly, the Top setting cannot exceed the Bottom setting (and vice versa).

<DSK mask setting> (figure shows the default values)

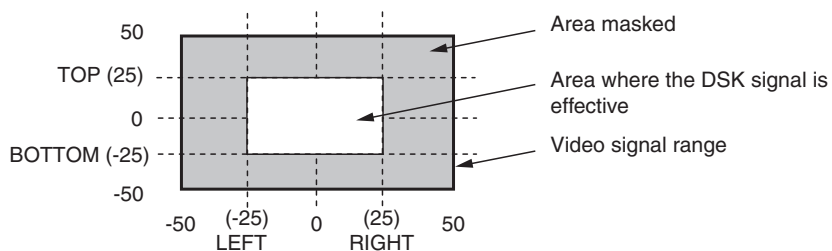

3. Basic operations

3-7. FTB (fade to black)

The user can fade out from a program image to the black screen or fade in to a program image from a black screen.

- ① Set the duration of the transition.
On the TIME menu, turn [F1] to display the FTB sub menu.
As with a background transition, set the transition time.
☞ See “3-1-6. Auto transition”.

- ② When the [FTB ON] button in the transition area is pressed, fade-out to the black screen is initiated.



During fade-out, the indicator of the [FTB ON] button blinks in red, and it lights in red when the transition (fade-out) is completed, and the black screen is displayed.*1

When the [FTB ON] button is pressed with the black screen displayed, fade-in to the program image is initiated.

During fade-in, the indicator of the [FTB ON] button lights in red, and it goes off when the transition (fade-in) is completed.

If the [FTB ON] button is pressed during the transition, the transition direction is reversed.

*1: In the FTB status, the crosspoint button which is normally lighted in red lights in amber.

3. Basic operations

3-8. Internal color signals

3-8-1. Setting the color background

The color background to be used by the bus can be set.

Two methods are available: under one method the Hue (hue), Sat (color saturation) and Lum (luminance) are set, and under the other the 8 preset colors (white, yellow, cyan, green, magenta, red, blue and black) are called.

The Hue, Sat and Lum of the called colors can also be adjusted.

Adjusting the colors

① Press the [CBGD] button and display the CBGD menu.

☞ Refer to “2-1-5. LCD menu area”.

<Menu display>

CBGD	1	Hue	Sat	Lum	Load↓
CBGD		0.0	0.0	100.0	White
		0.0	0.0	0.0	Yellow
					Cyan
		359.9	100.0	108.0	Green
					Magenta
					Red
					Blue
					Black

② Turn [F2], [F3] and [F4] to perform the color adjustments (Hue, Sat and Lum).

Calling the preset colors

Turn [F5] to select the preset color using the Load item, and press the [F5] switch.

The Hue, Sat and Lum values are changed to the preset color values.

- To save the values that were set before calling the preset color, refer to “3-10. Memory”.

3. Basic operations

3-9. Switching the AUX output

3-9-1. Selecting the AUX output materials

The AUX1 to AUX4 output signals can be selected.

- ① Press one of the [AUX1] to [AUX4] buttons among the AUX bus selector buttons.
The selected button lights in amber.
- ② Press one of the AUX bus crosspoint buttons.
The selected signal is output to the pressed [AUX1] to [AUX4] button.

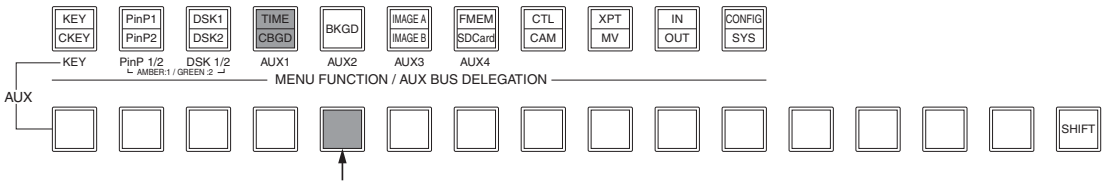

The button with the signals selected by AUX1 lights in amber.

<Signals that can be selected by the AUX bus>

Name of signal	Description of signal
INPUT1 to 20	Input signal 1 to 20
PGM	Program video signal
PVW	Preview video signal
CLN	Clean signal
MV1, MV2	Multi view display output signal 1, 2
KeyOut	Key output signal
FMEM1 to FMEM4	Frame memories 1 to 4
CBGD	Color background
CBAR	Color bar

- When the AUX bus is selected on the sub screen of the multi view display, the image is looped as if two mirrors have been placed opposite each other.

3. Basic operations

3-9-2. AUX1 transitions

The MIX transition is executed when the output signal set for AUX1 is switched.

- ① Press the [AUX1] button of the AUX bus selector buttons.
The selected button and its corresponding AUX bus crosspoint button light in amber.

- ② Press the AUX bus crosspoint button for the output signal to be switched to.
The MIX transition is now initiated for the length of the transition time that was set using the TIME menu.
While the transition is underway, the transition source AUX button lights in green, and the transition destination AUX button blinks in amber.
As soon as the transition is completed, the transition source AUX button goes off, and the transition destination AUX button lights in amber.
Furthermore, when another signal is selected at a midway point through a transition, the transition processing continues from that midway point.

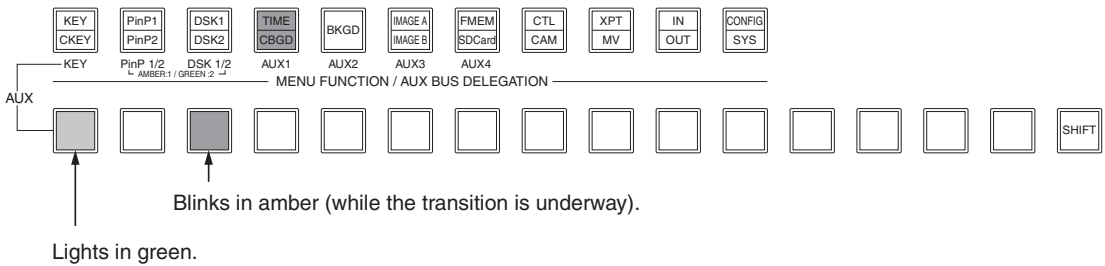

3. Basic operations

3-9-3. Setting enable/disable for the AUX1 transition

The AUX1 transition time and transition enable/disable can be set.

- ① Press the [TIME] button to light its indicator and display the TIME menu.
☞ Refer to “2-1-5. LCD menu area”.
- ② Turn [F1] to display the AUX1 sub menu.
- ③ Turn [F4] to select the display unit using the Unit item.
- ④ If frame has been selected as the unit, turn [F2] or [F3] to set the length of the transition time.
- ⑤ If second (sec) has been selected as the unit, turn [F2] to set the second unit or turn [F3] to set the frame unit.

<Menu display>

TIME	7	TransTime	Unit	ENBL
AUX1		16s 39f	Sec	Enable

TIME	7	TransTime	Unit	ENBL
AUX1		999f	Frame	Enable

Disable

Any time in the range from 0 to 999f can be set. Depending on the video format, the time that can be set with a display in seconds will differ.

59.94i: max. 33s09f, **59.94p:** max. 16s39f, **50i:** max. 39s24f, **50p:** max. 19s49f,
24psf: max 41s15f, **23.98psf:** max 41s15f

- ⑥ Turn [F5] to set enable or disable for the transition using the ENBL item.

Enable: Enable

Disable: Disable

When disable has been set for the transition, the output signals are switched with no transition when the output signals set in AUX1 is switched.

3. Basic operations

3-10. Memory

Background transition patterns, PinP sizes, border widths and other video statuses can be stored in and recalled from the memory.

Depending on what statuses are to be stored in the memory, the SHOT memory, BKGD/WIPE memory, PinP memory and CAM memory are available. Furthermore, by setting effect dissolve, the switching from the current image to an image or operation stored in the SHOT memory can be changed smoothly.

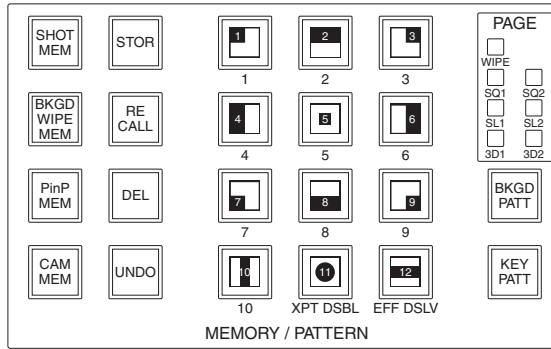

It is also possible to select the switcher (AV) system or camera (AW) system for the colors in which the function buttons are to light when memory operations (store, recall, delete) have been performed.

- Press the [CONFIG] button to light its indicator and display the CONFIG menu.

☞ Refer to “2-1-5. LCD menu area”.

- Turn [F1] to display the SHOT MEM sub menu.

<Menu display>

CONFIG 2	LEDMode		
SHOT MEM	AV		

AW

- Turn [F2] to select the lighting method for the function buttons using the LEDMode item.

AV: Switcher system (the buttons light in green).

AW: Camera system (the buttons light in amber).

3. Basic operations

3-10-1. Memory registration and recall items

	Material selected	Transition	Pattern	Menu
SHOT memory [SHOT MEM]	<ul style="list-style-type: none"> ● PGM/A bus ● PST/B bus ● PinP1 bus ● PinP2 bus ● KEY Fill bus ● DSK1 Fill bus ● DSK2 Fill bus 	<ul style="list-style-type: none"> ● Fader amount (BKGD, KEY) ● Wipe direction ● PinP1 ON/OFF ● PinP2 ON/OFF ● DSK1 ON/OFF ● DSK2 ON/OFF 	<ul style="list-style-type: none"> ● BKGD patterns (MIX, WIPE) ● KEY patterns (MIX, WIPE) 	<ul style="list-style-type: none"> ● KEY ● CHR KEY ● PinP1 ● PinP2 ● DSK1 ● DSK2 ● TIME (BKGD) ● TIME (KEY) ● TIME (PinP1, 2) ● TIME (DSK1, 2) ● TIME (EFF DSLV) ● TIME (FTB) ● TIME (AUX) ● IMAG A ● IMAG B ● CBGD ● BKGD
BKGD/WIPE memory [BKGD/WIPE MEM]	<ul style="list-style-type: none"> ● PGM/A bus ● PST/B bus 	<ul style="list-style-type: none"> ● Fader amount ● Wipe direction 	<ul style="list-style-type: none"> ● BKGD patterns (MIX, WIPE) 	<ul style="list-style-type: none"> ● TIME (BKGD) ● BKGD
PinP memory [PinP MEM]	<ul style="list-style-type: none"> ● PinP1 bus ● PinP2 bus 	<ul style="list-style-type: none"> ● PinP1 ON/OFF ● PinP2 ON/OFF 		<ul style="list-style-type: none"> ● PinP1 ● PinP2 ● TIME (PinP1, 2)
CAM memory [CAM MEM]	<ul style="list-style-type: none"> ● The preset numbers, which have been stored in the pan-tilt head selected, can be stored, recalled or deleted. 			

3. Basic operations

3-10-2. Storing the settings in the memory (Store)

The settings for the images and operations to be kept in the memory can be stored in the number keys (1 to 10).

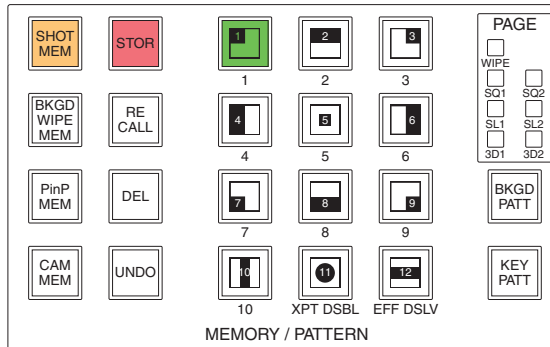

- ① Using the unit, set the images or operations to be kept in the memory.
- ② Press one of the buttons — [SHOT MEM], [BKGD WIPE MEM], [PinP MEM] or [CAM MEM] — to select the corresponding memory whose settings are to be stored.
The selected button lights in amber.
Depending on the operation that was performed last, the [STOR] button, [RECALL] button or [DEL] button lights.
- ③ Press the [STOR] button.
The [STOR] button lights in red.
- ④ Hold down (for about 2 seconds) the number key (1 to 10) in which the settings are to be stored. When the storing on the settings in the held-down button is completed, the pressed number key lights in green (or in amber with the AW system).
- ⑤ Repeat the above steps to register other types of settings in other number keys.
 - All the items of the selected type of the memory unit (SHOT memory, BKGD WIPE memory, PinP memory and CAM memory) are stored in one number key.
☞ Refer to “3-10-1. Memory registration and recall items”.
 - The preset numbers stored in the pan-tilt heads are used for the [CAM MEM] button. The numbers stored by the number keys in the memory area serve as the preset numbers of the pan-tilt heads.
 - No settings can be stored in the number key that is lighted in green (or in amber with the AW system) when the [STOR] button is pressed. First delete the memory settings in the number key, and then repeat the storage procedure.
 - Be careful when registering settings using the [CAM MEM] button, as preset numbers stored in the pan-tilt heads are forcibly registered.

3. Basic operations

3-10-3. Recalling the operations stored in the memory (Recall)

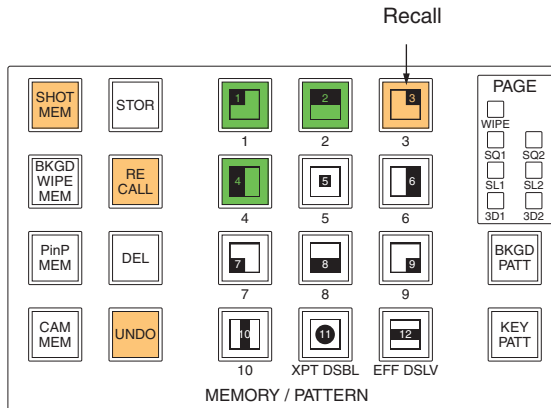

- ① Press one of the buttons — [SHOT MEM], [BKGD WIPE MEM], [PinP MEM] or [CAM MEM] — to select the corresponding memory whose operations are to be recalled.
The selected button lights in amber.
Depending on the operation that was performed last, the [STOR] button, [RECALL] button or [DEL] button lights.
- ② Press the [RECALL] button. The [RECALL] button lights in amber.
The button of the number key containing the stored operations lights in green (or in amber with the AW system).
 - However, it will not light if [CAM MEM] has been selected.
- ③ Press the number key (1 to 10) whose stored operations are to be recalled.
 - The items of the selected memory unit are targeted as the stored operations that will be recalled.
☞ Refer to “3-10-1. Memory registration and recall items”.
When another number button is pressed, the memory items stored in the pressed button will be recalled.
- ④ As soon as the stored operation that has been recalled is played, the [UNDO] button becomes operable, and it lights in amber.
If the [UNDO] button is pressed while it is lighted, the status before the stored operation is played will be restored.
 - When the [CAM MEM] button is selected, the [UNDO] button will have no effect so it will not light.
 - The [CAM MEM] button uses the preset numbers stored in the pan-tilt heads.
Bear in mind that if the preset details have been changed at the pan-tilt head after a preset number was stored using the [CAM MEM] button, it will be the changed details that will be recalled.
- ⑤ To exit memory recall, press the [STOR] button or [SHOT MEM] button.

XPT DSBL

When number key No.11 [XPR DSBL] is pressed while a stored operation is playing, it will light in amber. When the [RECALL] button is now pressed, the selected materials of the PGM/A bus, PST/B bus, KEY bus, PinP1/2 bus and DSK1/2 bus will be excluded from the target for stored operations.

- The number key No. 11 [XPT DSBL] will not light when the [CAM MEM] button is selected, as the operations of the key are disabled.

3. Basic operations

3-10-4. Deleting the operations stored in the memory (Delete)

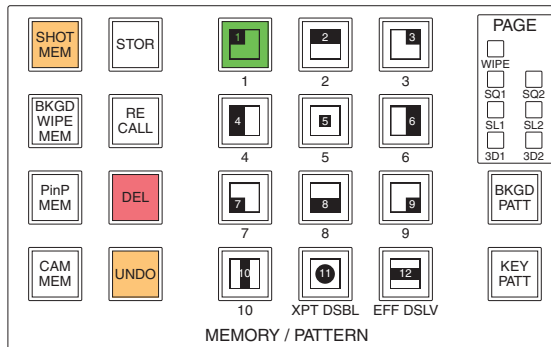

- ① Press one of the buttons — [SHOT MEM], [BKGD WIPE MEM], [PinP MEM] or [CAM MEM] — to select the corresponding memory whose operations are to be deleted.
The selected button lights in amber.
Depending on the operation that was performed last, the [STOR] button, [RECALL] button or [DEL] button lights.
- ② Press the [DEL] button.
The [DEL] button lights in red.
The button of the number key containing the stored operations lights in green (or in amber with the AW system).
 - However, it will not light when [CAM MEM] is selected.
- ③ Hold down (for about 2 seconds) the number key (1 to 10) used to delete the stored operations.
The button of the pressed number key goes off.
- ④ As soon as the stored operations are deleted, the [UNDO] button becomes operable and lights in amber. If the [UNDO] button is pressed while it is lighted, the status before the stored operation was deleted will be restored.
The [CAM MEM] button deletes specified preset numbers registered in the pan-tilt heads.
 - When the [CAM MEM] button is selected, the [UNDO] button will have no effect so it will not light.
- ⑤ To exit memory delete, press the [DEL] button or [SHOT MEM] button.

3. Basic operations

3-10-5. Effect dissolve

Switching from the current image to the image or operation stored in the SHOT memory can be performed smoothly.

For the items targeted by effect dissolve, refer to the SHOT memory items in “3-10-1. Memory registration and recall items”.

- ① Press the [SHOT MEM] button, and then press the [RECALL] button.
- ② Press number key No.12 [EFF DSLV] to enable effect dissolve.
When the function is enabled, the number key No.12 [EFF DSLV] lights in amber.
- ③ Press the number key (1 to 10) containing the stored operation.
The switching from the current image to the stored operation recalled by pressing the number key is performed smoothly. The time taken for the change is set on the EFF DSLV sub menu of the TIME menu.
☞ Refer to “2-1-5. LCD menu area”.

<Menu display>

TIME	8	TransTime	Unit	
EFF DSLV		1s	0f	Sec
	0~13S	0~999f	Frame	

Pressed number keys blink in green (or in amber with the AW system) while the operation switching is under way.

When the operation switching has been completed, the pressed number key lights in amber (or in green with the AW system).

- When number key No.12 [EFF DSLV] is pressed at any point during the operation switching, the switching is canceled, and switching is initiated to the operation of the number key that was selected at that instant.
- During the operation switching, the operation of the fader lever is canceled.
- During the operation switching, other stored operations cannot be recalled.
- When initiating PinP1/2 and DSK1/2 transitions, the switching process is not stored in the memory.
- The number key No.12 [EFF DSLV] will not light when the [CAM MEM] button is selected, as the operations of the key are disabled.

3. Basic operations

3-11. Frame memories

Still images can be stored in the unit's four internal frame memories for use. The still images are transferred to the frame memories through the AUX bus and an SD memory card. Conversely, the images in the frame memories can be transferred to an SD memory card. Images in the frame memories can be used as bus images by assigning FMEM1 to FMEM4 using the crosspoint assignment function. Data for images stored in the frame memory can be retained even when the power is turned off, by saving them in the flash memory area built into the mainframe.

3-11-1. Transferring images from the AUX bus

- ① Press the [FMEM] button to light its indicator and display the FMEM menu.
☞ Refer to "2-1-5. LCD menu area".
- ② Turn [F1] to display the AUX sub menu.

<Menu display>

FMEM	1	FMEM	Select	Review	Exec↓
AUX		FMEM1	AUX1	Off	
		FMEM1~4	AUX1~4	On	

- ③ Turn [F2] to select the frame memory in which to store the image using the FMEM item.
- ④ Turn [F3] to select the AUX bus from which to transfer the images using the Select item.
- ⑤ Turn [F4] to select on or off for the review display setting using the Review item.
 - On:** After the image has been imported, the images in the frame memory (FMEM1 to FMEM4) selected for the AUX bus are displayed (for 2 seconds).
 Even during review display, the next image can be imported.
 - Off:** No review display.
- ⑥ Press the [F5] switch (Exec) to import the still images to the frame memory.
 The still images can also be imported using the user buttons.
 "StrFM1" to "StrFM4" have been allocated to the user buttons (☞ See "5-3-1. Setting the user buttons".), and when one of these buttons is pressed, it will light for an instant, and the still image is then imported.

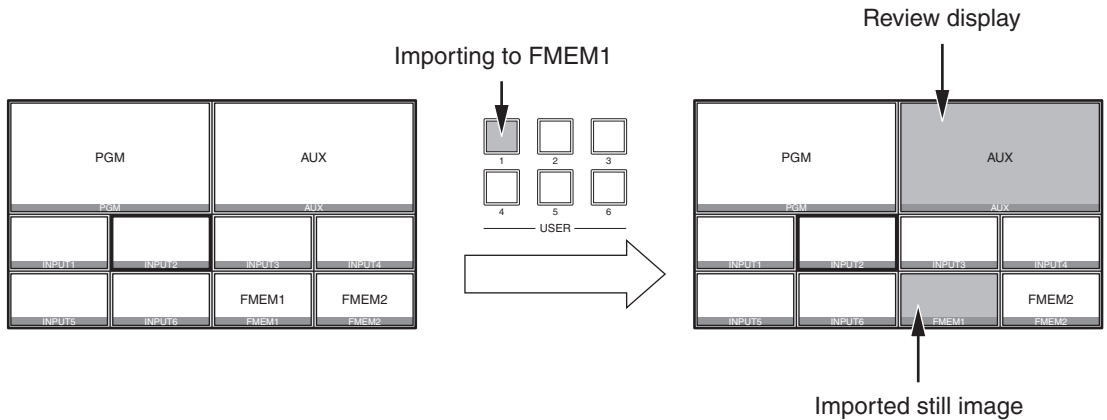

3. Basic operations

3-11-2. Saving Images in Flash Memory

Data for images stored in the frame memory can be retained even when the power is turned off, by saving them in the flash memory area built into the mainframe.

Whether to automatically save the image data stored in the frame memory when the data is transferred from the AUX bus or to manually save them must be set.

Care must be taken when selecting manual saving, as image data stored in the frame memory will be lost if the power to the mainframe is turned off before the saving operation is completed.

- ① Light the [FMEM] button by pressing it, and display the FMEM menu.

☞ Refer to “2-1-5. LCD menu area”.

- ② Turn [F1] to display the Memory sub menu.

<Menu display>

FMEM 2	Mode	Select		Exec↓
Memory	AUTO	ALL		

Manual	FMEM1~4
--------	---------

- ③ Turn [F2] to select the saving method in the Mode item.

AUTO: Automatic saving

Manual: Manual saving

- ④ Turn [F3] to select the frame memory for saving data in the flash memory area in the Select item.

Selecting [ALL] will save data in all frame memory areas, from FMEM1 to FMEM4.

- ⑤ Press the [F5] switch (Exec) to save data in the flash memory area.

- The [F5] switch becomes enabled when “Manual” is selected in the Mode item.

3. Basic operations

3-12. SD memory cards

The unit's frame memory data and system data can be stored on SD memory cards. Conversely, this data can be loaded from the SD memory cards to the unit.

Frame memory data (still image data):

The unit supports 24-bit (uncompressed) BMP (bitmap) and JPEG (baseline) is the only file formats.

JPEG format files can be loaded, but they become BMP format files when they are stored from the unit to the SD memory card.

This unit cannot resize the images so resize them appropriately using another device such as a personal computer before saving them on the SD memory card.

<Applicable sizes>

HD/1080i: 1920×1080, HD/1080psf: 1920×1080, HD/720p: 1280×720,
SD/NTSC: 720×487, SD/PAL: 720×576

BMP files:

If the sizes are different, the center of the images will be lined up.

If the image is large, it will be cropped.

If the image is small, the area around it will be filled in with a black border.

JPEG files:

Images in the sizes listed in "Applicable sizes" above can be loaded.

The pixels of images in SD format are not square, so the aspect ratio will be different when the images are displayed on the computer and when they are imported into frame memory (with NTSC format, they will be vertically long).

To keep the images true to their actual proportions, make sure the original size is 720×540 pixels. If the images are in NTSC format, use images shrunk to 720×487 pixels. If the images are in PAL format, use images enlarged to 720×576 pixels.

System data:

The "system data" refers to all the data stored in the unit with the exception of the date, time and network settings and of the still image data. The extension used for the system data files is "h45".

SD memory card handling precautions

- Do NOT eject the SD memory card while the SD memory card access LED is lighted.
When an SD memory card is ejected while the SD memory card access LED is lighted, the transition of the operation from data access to card ejection may be temporarily suspended.
In addition, the data stored on the SD memory card may be lost.
- The data stored on SD memory cards may be lost as a result of misplacing the cards or performing erroneous operations, for instance. It is recommended that valuable data be stored on a personal computer or other device.

3. Basic operations

3-12-1. Initializing the SD memory cards

In order for an SD memory card to be used in the unit, **it must first be initialized by the unit**. Initializing the SD memory card formats it (in compliance with the SD standard) and creates the dedicated directory. (All files saved on the SD memory card will be erased.)

- ① Insert the SD memory card into the unit's SD memory card slot.
- ② Press the [SDCard] button to light its indicator and display the SDCard menu.
☞ Refer to "2-1-5. LCD menu area".
- ③ Turn [F1] to display the File sub menu.

<Menu display>

SDCard 1	Mode↓	Select		Init↓
File	*Init	-		No



SDCard 1	Mode↓	Select		Init↓
File	*Init	-		Yes

- ④ Turn [F2] to select "Init" using the Mode item, and then press the [F2] switch.
The "Init?" message now appears.
If the SD memory card has not been inserted, "No Card" will appear at the Mode item.
When the mode is selected, an asterisk (*) appears on the left of the selected mode (Init, Save, Load or Delete).
If an asterisk does not appear, press the [F2] switch to select a mode.
- ⑤ Turn [F5] to select "Yes," and press the [F5] switch to initialize the card.

If "Load", "Save" or "Delete" is selected and then the [F2] switch is pressed after a SD memory card not formatted in compliance with the SD standard has been inserted, a message indicating that "This card is not usable Please initialize it" is displayed.

☞ See "3-12-2. Saving data on SD memory cards" to "3-12-4. Deleting files on SD memory cards".

Before using a SD memory card in this unit, initialize it.

This unit also supports SDHC memory cards.

Memory cards can be initialized no matter whether they are SD or SDHC memory cards.

3. Basic operations

3-12-2. Saving data on SD memory cards

- ① Insert the SD memory card which has been initialized by the unit, into the SD memory card slot.
- ② Press the [SDCard] button to light its indicator and display the SDCard menu.
☞ Refer to “2-1-5. LCD menu area”.
- ③ Turn [F1] to display the File sub menu.
- ④ Turn [F2] to select “Save” using the Mode item, and then press the [F2] switch.

<Menu display>

SDCard 1	Mode↓	Select	SaveFile	Exec↓
File	*Save	-		
		FMEM1~4		
		SetUp		

- ⑤ Turn [F3] to select the data which is to be stored on the SD memory card using the Select item.
FMEM1 to 4: Still image data in frame memories 1 to 4
SetUp: Setup data
- ⑥ If the [F5] switch is now pressed, the file is stored on the SD memory card.
Filenames are provided automatically using the running number as shown below.

HS001.bmp to HS999.bmp

<Configuration of folder at storage destination>

System data:	“HS400\SETUP” folder
Still image data:	“HS400\IMAGE” folder

While the file is being stored, the following message and filename are displayed.

SDCard 1	···Saving File···	
File		HS001

3. Basic operations

3-12-3. Loading data from SD memory cards

- ① Insert the SD memory card on which the data is stored into the SD memory card slot.
Load the file after its data has been stored in the each folder.
Data stored in other folders will not be recognized by the unit.

System data: "HS400\SETUP" folder
Still image data: "HS400\IMAGE" folder

- ② On the SDCard menu, turn [F1] to display the File sub menu.
③ Turn [F2] to select "Load" using the Mode item, and then press the [F2] switch.

<Menu display>

SDCard 1	Mode↓	Select	LoadFile	Exec↓
File	*Load	-		HS001

FMEM1~4
SetUp

- ④ Turn [F3] to select the transfer destination using the Select item.
⑤ Using the LoadFile item, turn [F4] to select the name of the file to be loaded.
If the name of the file to be loaded consists of more than 8 characters, a shortened version of the filename will be displayed.
⑥ If the [F5] switch is now pressed, the file is loaded from the SD memory card and stored in the unit's internal memory.
While the file is being loaded, the following message and filename are displayed.

SDCard 1	···Loading File···
File	HS001

- Up to 999 files can be loaded.
- The following alphanumeric and symbols can be used as the characters for filenames (see below).
Files using other characters will not be displayed by the unit.

<Characters which can be used for filenames>

A to Z, a to z, 0 to 9, Space, ! # \$ % & ' () - . @ ^ _ ` { }

3. Basic operations

3-12-4. Deleting files on SD memory cards

- ① Insert the SD memory card on which the data is stored into the SD memory card slot.
- ② On the SDCard menu, turn [F1] to display the File sub menu.
- ③ Turn [F2] to select “Delete” using the Mode item, and then press the [F2] switch.

<Menu display>

SDCard 1	Mode↓	Select	De1File?	No
File	*Delete	-	HS001	
		FMEM		Yes↓
		SetUp		

- ④ Turn [F3] to select FMEM (still image data) or SetUp using the Select item.
If the name of the file to be loaded consists of more than 8 characters, a shortened version of the filename will be displayed.
- ⑤ Using the De1File? item, turn [F4] to select the name of the file to be deleted.
- ⑥ Turn [F5] to select “Yes”, then press the [F5] switch, and the file is now deleted.

3-12-5. Displaying the SD memory card information

- ① Insert the SD memory card on which the data is stored into the SD memory card slot.
- ② On the SDCard menu, turn [F1] to display the CardInfo menu.

<Menu display>

SDCard 2	Images	FreeSpace	GetInf↓
CardInfo	1	496MB/500MB	

- Images:** The number of still image files stored on the SD memory card is displayed.
The number of files that can be loaded using the unit is 999.
“Over999” is displayed when an attempt is made to store 1000 or more files.
- FreeSpace:** The SD memory card’s total memory and remaining free space are displayed in megabyte units (MB).
(Free space/card’s total memory)

- ③ Press the [F5] switch, and the display of information of Images item and FreeSpace item is updated.

4. Input/output signal settings

4-1. Input signal settings

IN1 to IN6 are SDI signal inputs.

IN A1, IN A2, IN B1 and IN B2 can be set only when one of the following option boards has been connected.

- AV-HS04M1 (SDI Input Board)
- AV-HS04M2 (Analog Input Board)
- AV-HS04M3 (DVI Input Board)
- AV-HS04M6 (Analog Composite Input Board)
- AV-HS04M8 (Full-HD DVI Input Board)

<List of settings by input signal>

Input connector		Setting menu and numbers of sections in this manual				
		FS	Mode	Freeze	ColCor	UpConv
		4-1-1	4-1-2	4-1-3	4-1-4	4-1-5
IN1 to IN8	Standard SDI input × 16 lines	✓	Only DbyD selectable	✓	—	—
IN9 to IN16		✓		✓	—	
IN13 to IN16		✓	✓	✓	✓	✓
Option slot IN A1, IN A2, IN B1, IN B2	AV-HS04M1 SDI input × 2 lines	✓	✓	✓	—	✓
	AV-HS04M2 Analog component input × 2 lines	✓	✓	✓	—	✓
	AV-HS04M3 DVI-I input × 2 lines	—	—	✓	—	—
	AV-HS04M6 Analog composite input × 2 lines	✓	✓	✓	—	✓
	AV-HS04M8 DVI-D input × 2 line	—	—	✓	—	—

Input connector		Setting menu and numbers of sections in this manual			
		AnaGain	Setting	DVIIn (Dig)	DVIIn (Ana)
		4-1-6	4-1-7	4-2	4-2
IN1 to IN8	Standard SDI input × 16 lines	—	—	—	—
IN9 to IN16		—	—	—	—
IN13 to IN16		—	—	—	—
Option slot IN A1, IN A2, IN B1, IN B2	AV-HS04M1 SDI input × 2 lines	—	—	—	—
	AV-HS04M2 Analog component input × 2 lines	✓	—	—	—
	AV-HS04M3 DVI-I input × 2 lines	—	—	✓	✓
	AV-HS04M6 Analog composite input × 2 lines	✓	✓	—	—
	AV-HS04M8 DVI-D input × 2 line	—	—	✓	—

✓: Can be set.
—: Cannot be set.

4. Input/output signal settings

4-1-1. Setting the frame synchronizer

The frame synchronizer can be set to On or Off for each input.

The DVI input (option) frame synchronizer is permanently On. It cannot be set from On to Off or vice versa.

- ① Press the [INPUT] button to light its indicator and display the INPUT menu.
☞ Refer to “2-1-5. LCD menu area”.
- ② Turn [F1] to display the INPUT XX sub menu.
(X: IN1 to IN16, A1, A2, B1 or B2)
The input used to set the frame synchronizer function is selected for X.
- ③ Turn [F2] to display the third menu of FS.

<Menu display>

INPUT XX	FS	FS	Mode↓	CC
	1/13	On	*Normal	Off
		Off	DbyD	On
			UC	
			Auto	

- ④ Turn [F3] to set On or Off for the frame synchronizer using the FS item.
 - If the output signal phase is set to 0H, Off cannot be selected as the FS item setting.

AVDL function is active while the frame synchronizer function is set to Off.

The AVDL function automatically adjusts the input image signal phase to the horizontal synchronization reference signal phase.

For details, refer to “4-7. Adjusting the output signal phase”.

4. Input/output signal settings

4-1-2. Setting the input mode

The mode can be set for each input only when HD has been selected as the system format. When SD is selected as the system format, the input mode is always the same as Normal.

Normal: Input signals in conformity with the system format take effect.

D by D: When SD signals with the same frame rate as the system format have been input, they are input on a dot by dot (1× magnification) basis with no up-conversion. (This setting is only possible when the system format is 1080i.) In this mode, there is minimal deterioration in the image quality and, as such, the mode is used to combine SD format material using the PinP function.

UC: When SD signals with the same frame rate as the system format have been input, they are up-converted.

Auto: Input signals in conformity with the system format take effect. Furthermore, if SD signals with the same frame rate as the system format are input when HD is selected as the system format, they are up-converted.

- In the Auto mode, the images may be disturbed when the input signals are switched.

- ① On the INPUT XX sub menu, turn [F4] to set the input mode using the Mode item, and press the [F4] switch to enter the setting.
An asterisk (*) appears at the left of the input mode currently selected.

<List of input modes supported>

System	Mode	Input							
		480 /59.94i	576 /50i	1080 /59.94i	1080 /50i	1080 /24psf	1080 /23.98psf	720 /59.94p	720 /50p
SD	480/59.94i	✓	■	■	■	■	■	■	■
	576/50i	■	✓	■	■	■	■	■	■
HD	1080/59.94i	Normal	■	■	✓	■	■	■	■
		DbyD	✓	■	■	■	■	■	■
		UC	✓	■	■	■	■	■	■
		Auto	✓ (UC)	■	✓	■	■	■	■
	1080/50i	Normal	■	■	■	✓	■	■	■
		DbyD	■	✓	■	■	■	■	■
		UC	■	✓	■	■	■	■	■
		Auto	■	✓ (UC)	■	✓	■	■	■
	1080/24psf	Normal	■	■	■	■	✓	■	■
		DbyD	■	■	■	■	■	■	■
		UC	■	■	■	■	■	■	■
		Auto	■	■	■	■	■	■	■
	1080/23.98psf	Normal	■	■	■	■	■	✓	■
		DbyD	■	■	■	■	■	■	■
		UC	■	■	■	■	■	■	■
		Auto	■	■	■	■	■	■	■
720/59.94p	Normal	■	■	■	■	■	■	✓	
	UC	✓	■	■	■	■	■	■	
	Auto	✓ (UC)	■	■	■	■	■	✓	
720/50p	Normal	■	■	■	■	■	■	✓	
	UC	■	✓	■	■	■	■	■	
	Auto	■	✓ (UC)	■	■	■	■	✓	

- ■ denotes a black screen.
- The UC mode or Auto mode cannot be selected for inputs 1 to 4.
- If D by D, UC or Auto mode is selected, the frame synchronizer will be turned on.
- The input mode cannot be changed when freeze is set to on.

4. Input/output signal settings

4-1-3. Freezing the input signals

The input signals can be frozen and used.

While signals are frozen, the tally signals of the corresponding input will not be output.

Setting freeze

- ① Press the [INPUT] button to light its indicator and display the INPUT menu.

☞ Refer to “2-1-5. LCD menu area”.

- ② Turn [F1] to display the INPUT XX sub menu.

(X: IN1 to IN16, A1, A2, B1 or B2)

The input used to set the freeze function is selected for X.

- ③ Turn [F2] to display the third menu of Freeze.

<Menu display>

INPUT XX	Freeze	Select	Freeze↓	
	2/13	Frame	Off	
		Field	On	

- ④ Turn [F3] to select the freeze method using the Select item.

Frame: The images are frozen frame by frame.

Field: The images are frozen field by field.

This is used to freeze moving images.

With interlace signals, however, diagonal lines and moving parts appear jagged.

Frame or Field can also be selected while an image is frozen.

- ⑤ Press the [F4] switch to freeze the input image or cancel the freeze.

If the [F4] switch is pressed while the display is “Off”, the video signal is frozen, and the display is set to “On”.

If the [F4] switch is pressed while the display is “On”, the video signal freezing is canceled, and the display is set to “Off”.

The “F” mark appears in front of the name of the material when the signals set for output of multi view displays are frozen.

- When the unit is used with the frame synchronizer function OFF, the output images may be disturbed when freezing is executed, but the frozen images will not be adversely affected.
- If, when the switcher is used with the frame synchronizer function at OFF, “On” is set as the freeze setting, the frame synchronizer function will be automatically switched to ON.

4. Input/output signal settings

4-1-4. Color corrector

When the color corrector is enabled, the colors of the input video signals can be corrected. This function can be set for the signals that are input to IN9 to IN16.

Enabling the color corrector

- ① Press the [INPUT] button to light its indicator and display the INPUT menu.
☞ Refer to “2-1-5. LCD menu area”.
- ② Turn [F1] to display the INPUT XX sub menu.
(X: IN9 to IN16)
The input used to enable the color corrector function is selected for X.
- ③ Turn [F2] to display the third menu of FS.

<Menu display>

INPUT XX	FS	FS	Mode↓	CC
	1/13	On	*Normal	Off
		Off	DbyD	On
			UC	
			Auto	

- ④ Turn [F5] to select On using the CC item.

On: The color corrector function is enabled.

Off: The color corrector function is disabled.

- When the color corrector function is enabled (CC item is set to On), the ClorCnv item on the third CC menu is automatically set to On as well.
When the ClorCnv item on the third CC menu is set to Off, the CC item on the third FS menu is automatically set to Off as well.

<Menu display>

INPUT XX	CC	MTX	Limiter	CLEAR↓
	6/13	On	100	ALL
		Off		

4. Input/output signal settings

Process control

■ Adjusting the Y signal gain and setting its slice level

- ① On the INPUT XX sub menu, turn [F2] to display the third menu of CC Prc1.

<Menu display>

INPUT XX	CC Prc1	Y-Gain	Slice
	7/13	100.0	0.0
		0.0	-7.0
		200.0	108.0

- ② Turn [F3] to set the gain value of the Y signal using the Y-Gain item.
③ Turn [F4] to set the slice level using the Slice item.

■ Adjusting the gain and hue of the C signal

- ① On the INPUT XX sub menu, turn [F2] to display the third menu of CC Prc2.

<Menu display>

INPUT XX	CC Prc2	C-Gain	Hue
	8/13	100.0	0.0
		0.0	0.0
		200.0	359.9

- ② Turn [F3] to set the gain value of the C signal using the C-Gain item.
③ Turn [F4] to set the hue value using the Hue item.

4. Input/output signal settings

Tone curve

The gray scale of the input images can be compensated. Set the tone curve, and adjust the image brightness, contrast and other characteristics. Furthermore, by adjusting each of the R, G and B colors separately, the white balance and color tone can be adjusted.

- On the INPUT XX sub menu, turn [F2] to display the third menu of CC Trn1.

<Menu display>

INPUT XX	CC Trn1	RGB	Manual	GrayPos
	9/13	R	ALL	0.50
		G	Free	0.25
		B		0.75

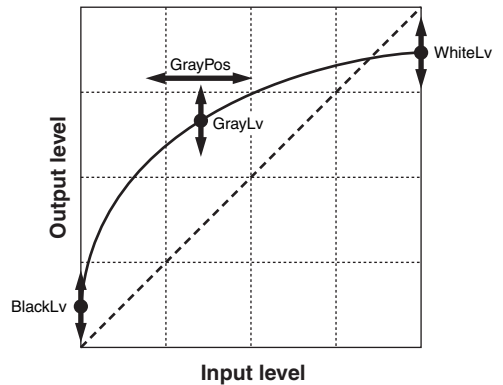

- Turn [F3] to select the color to be compensated using the RGB item.
R: red, **G:** green, **B:** blue
- Turn [F4] to set the compensation mode using the Manual item.
ALL: The R, G and B colors are all set to the same value.
When the mode has been set to ALL, the colors set using the RGB item are canceled.
Free: Each of the R, G and B colors is set separately.
- Turn [F5] to set the gray level position using the GrayPos item.
- Turn [F2] to display the third menu of CC Trn2.

<Menu display>

INPUT XX	CC Trn2	BlackLv	GrayLv	WhiteLv
	10/13	0.00	0.50	1.00
		0.00	0.25	0.50
		0.50	0.75	1.00

- Turn [F3] to set the black level using the BlackLv item.
- Turn [F4] to set the gray level using the GrayLv item.
- Turn [F5] to set the white level using the WhiteLv item.

4. Input/output signal settings

Adjusting the color matrix item gain

- ① On the INPUT XX sub menu, turn [F2] to display the third menu of CC MTX1.

<Menu display>

INPUT XX	CC MTX1	R-G	R-B	
	11/13	0.00	0.00	
		-1.00	-1.00	
		1.00	1.00	

- ② Turn [F3] to set the matrix item R-G gain value using the R-G item.
- ③ Turn [F4] to set the matrix item R-B gain value using the R-B item.
- ④ In the same way, set the matrix item G-R and G-B gain values using the third menu of CC MTX2, and set the matrix item B-R and B-G gain values using the third menu of CC MTX3.

4. Input/output signal settings

4-1-5. Setting the up-converter

Select the settings for INPUT13 to 16, as well as for the up-converter that is built into the optional boards listed below:

- AV-HS04M1 (SDI Input Board)
- AV-HS04M2 (Analog Input Board)
- AV-HS04M6 (Analog Composite Input Board)

① Press the [INPUT] button to light its indicator and display the INPUT menu.

☞ Refer to “2-1-5. LCD menu area”.

<Menu display>

INPUT XX	UpConv1	Scale	MovDet↓	Sharp↓
	4/13	*SQ	*3	*3
		EC	1~5	1~5
		LB		

② Turn [F1] to display the INPUT XX sub menu.

(X: IN1 to IN16, A1, A2, B1 or B2)

The input used to set the up-converter is selected for X.

③ Turn [F2] to display the third menu of UpConv1.

④ Turn [F3] to select the scaling system using the Scale item, and press the [F3] switch to enter the selection.

SQ (squeeze): The image is enlarged both horizontally and vertically to fill the entire screen.

EC (edge crop): The aspect ratio of the image is maintained, the image size is increased in accordance with the vertical resolution, and black bands are added at the left and right.

LB (letter box): The aspect ratio of the image is maintained, the image size is increased in accordance with the horizontal resolution, and the image is cropped at the top and bottom.

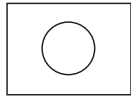
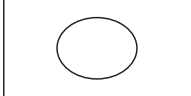
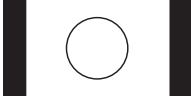
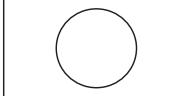
Input image	SQ	EC	LB
			

⑤ Turn [F4] to set the image movement detection sensitivity using the MovDet item, and press the [F4] switch to enter the selection.

1: Toward still images ↔ 3: standard ↔ 5: toward moving images

⑥ Turn [F5] to set the extent of the edge sharpness for the images using the Sharp item, and press the [F5] switch to enter the selection.

1: Not sharp edges ↔ 3: standard ↔ 5: very sharp edges

4. Input/output signal settings

Fine-tuning of image positions

Fine-tuning of image positions is performed when EC (edge crop) is selected for the scaling method.

- ① On the INPUT XX sub menu, turn [F2] to display the third menu of UpConv2.

<Menu display>

INPUT XX	UpConv2	EC-Pos		
	5/13	Center		
		Right		
		Left		

- ② Turn [F3] to select the image position using the EC-Pos item.

Center: The image is positioned at the center, and black images are added at the left and right.

Right: The image is positioned at the right, and a black image is added at the left.

Left: The image is positioned at the left, and a black image is added at the right.

4-1-6. Setting the analog input gain (option)

When the analog input board (option) has been connected, the gain of the input signals can be set.

Alternatively, when the analog composite input board (option) has been connected, the gain of the Y signals can be set.

The setting range is ± 30 steps, and the gain changes by approximately ± 2 dB. The amount of change in the gain when it is changed by one step is not fixed.

- ① Press the [INPUT] button to light its indicator and display the INPUT menu.

☞ Refer to "2-1-5. LCD menu area".

- ② Turn [F1] to display the INPUT XX sub menu.

(X: A1, A2, B1 or B2)

The input used to set the gain is selected for X.

- ③ Turn [F2] to display the third menu of FS.

<Menu display>

INPUT XX	FS	FS	Mode↓	AnaGain
	1/6	On	*Normal	0
				-30
				+30

- ④ Turn [F5] to set the gain of the input signal (Y signal gain) using the AnaGain item.

4. Input/output signal settings

4-1-7. Setting the analog composite input signals (option)

When the analog composite input board (option) has been connected, the analog composite input signals can be set.

- ① Press the [INPUT] button to light its indicator and display the INPUT menu.
☞ Refer to “2-1-5. LCD menu area”.
- ② Turn [F1] to display the INPUT XX sub menu.
(X: A1, A2, B1 or B2)
The input used to set the analog composite signal is selected for X.
- ③ Turn [F2] to display the third menu of Setting.

<Menu display>

INPUT XX	Setting	Chroma	Ped	Hue
	3/5	0	0	0
		-8~+7	-100 +100	-30~+30

- ④ Turn [F3] to adjust the chroma level using the Chroma item.
(Maximum amount of variation: approx. ± 3 dB)
The Auto Color Control function is activated, and the chroma level is kept at the value that has been set.
- ⑤ Turn [F4] to adjust the pedestal level using the Ped item.
(Maximum amount of variation: approx. ± 100 mV)
- ⑥ Turn [F5] to adjust the hue using the Hue item.
(Maximum amount of variation: approx. $\pm 20^\circ$)
Adjustment of Hue is possible when the system format is 1080/59.94i, 720/59.94p and 480/59.94i.

For details on the other settings, refer to the operating instructions of the optional board.

4. Input/output signal settings

4-2. Setting the DVI input signals (option)

4-2-1. Setting the DVI input signals

Set the DVI input signals when the DVI input board (option) or full HD DVI input board (option) has been connected.

Signals with the following resolutions can be input.

If signals with any other resolution or frequency are input, the picture will turn black.

DVI Input Board (Digital/Analog)	
● XGA	(1024×768), 60 Hz
● WXGA	(1280×768), 60 Hz
● SXGA	(1284×1024), 60 Hz

Full-HD DVI Input Board (Digital)	
● XGA	(1024×768), 60 Hz
● WXGA	(1280×768), 60 Hz
● SXGA	(1284×1024), 60 Hz
● WSXGA+	(1680×1050), 60 Hz
● UXGA	(1600×1200), 60 Hz
● WUXGA	(1920×1200), 60 Hz
● 1080/59.94P	(1920×1080), 59.94 Hz
● 1080/50P	(1920×1080), 50 Hz

① Press the [INPUT] button to light its indicator and display the INPUT menu.
☞ Refer to “2-1-5. LCD menu area”.

② Turn [F1] to display the INPUT XX sub menu.
(X: A1, A2, B1 or B2)
The input used to set the DVI signals is selected for X.

③ Turn [F2] to display the third menu of DVIIn.

<Menu display>

INPUT XX	DVIIn	Mode	Scale	Auto↓
	3/4	Dig	Fit-V	Black
		Ana	Fit-H	White
			Full	Init

④ Turn [F3] to select the signal system using the Mode item.
● Set this when the DVI input board (AV-HS04M3) has been connected.
Dig: Digital input signals of the DVI connector are effective.
Ana: Analog input signals of the DVI connector are effective.

4. Input/output signal settings

⑤ Turn [F4] to select the scaling method.

Fit-V: The aspect ratio of the input images is maintained, and the size of the images is increased or reduced in accordance with the vertical resolution.

Fit-H: The aspect ratio of the input images is maintained, and the size of the images is increased or reduced in accordance with the horizontal resolution.

Full: The size of the input images is increased or reduced in accordance with the system resolution. (The aspect ratio of the input images is not kept the same. The rate at which the image size is increased or reduced in the vertical direction and in the horizontal direction differs.)

For details on the sizes that correspond to the formats, refer to “DVI input scaling size table” on the next page.

⑥ The black level (offset) and white level (gain) of the analog input signals are adjusted automatically.

- Set this when the DVI input board (AV-HS04M3) has been connected.

Depending on the personal computer used, there may be some deviation from the correct levels of the black level or white level.

To proceed with automatic adjustment to correct this deviation, display the black-and-white signals (BW.bmp) on the supplied CD-ROM or the full-screen black signals and full-screen white signals on the personal computer connected to the DVI input connector, and input these signals as the DVI input signals.

When using the black-and-white signals, position them so that the boundary between black and white comes to the center of the monitor screen.

When using the full-screen black signals or full-screen white signals, display the black or white in an area that covers at least 80 % of the screen from the screen center.

Before making any adjustments, follow the instructions given in the “Automatic adjustment of the black level” section.

Automatic adjustment of the black level

Input the black-and-white signals (BW.bmp) or full-screen black signals.

Turn [F5] to select “Black” in the Auto item, and press [F5] to adjust the black level automatically.

“... During Auto Setting ...” is displayed on the LCD while adjustments are being made.

Automatic adjustment of the white level

Input the black-and-white signals (BW.bmp) or full-screen white signals.

Turn [F5] to select “White” in the Auto item, and press [F5] to adjust the white level automatically.

“... During Auto Setting ...” is displayed on the LCD while adjustments are being made.





Initializing the adjusted values

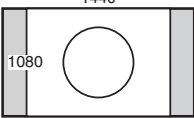
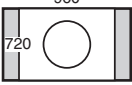
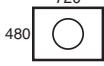
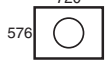
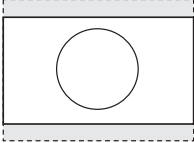
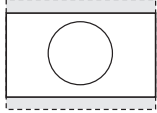
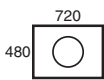
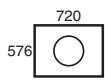
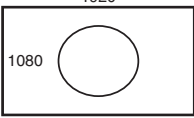
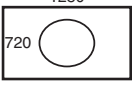
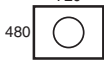
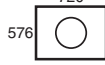
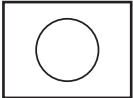
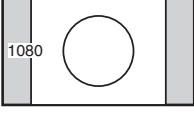
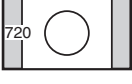

Turn [F5] to select “Init” in the Auto item, and press [F5] to return the adjusted values to their factory settings.

“... During Auto Setting ...” is displayed on the LCD while adjustments are being made.

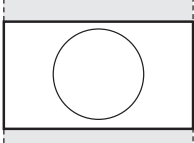
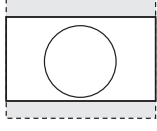
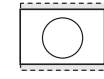
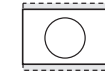
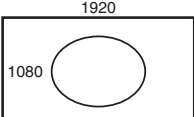
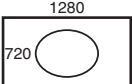
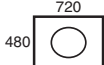
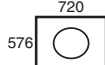
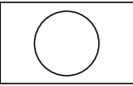
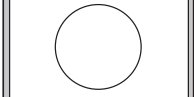
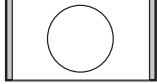

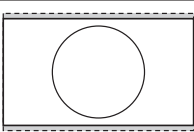
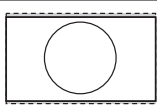
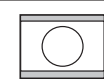
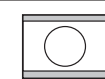
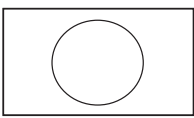
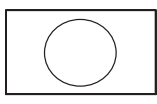
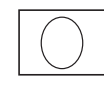
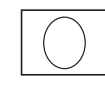





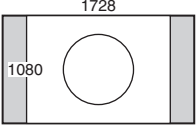
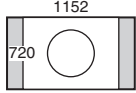
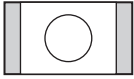
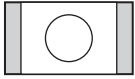
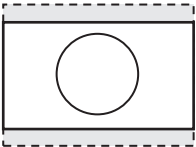
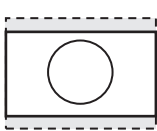

4. Input/output signal settings

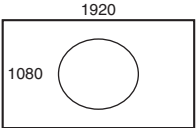
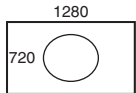
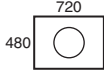
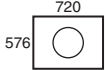
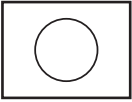
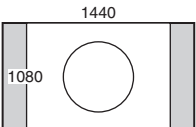
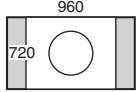
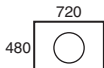
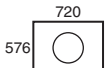
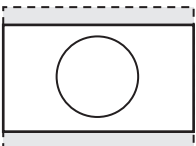
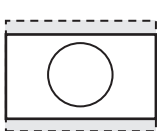
■ DVI input scaling size table

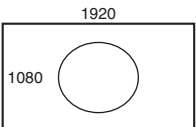
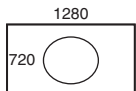
DVI format	Mode	HD/1080i	HD/720P	SD/NTSC	SD/PAL
		1920 × 1080	1280 × 720	720 × 480	720 × 576
XGA 1024×768 	Fit-V				
	Fit-H				
	Full				
SXGA 1280×1024 	Fit-V				
	Fit-H				
	Full				
WXGA 1280×768 	Fit-V				
	Fit-H				
	Full				

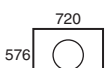
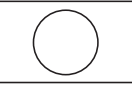
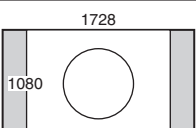
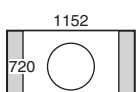
 : Black images are inserted here.
 : The parts of the images protruding in these areas are cropped.

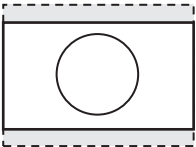
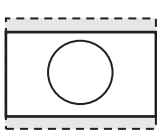
4. Input/output signal settings

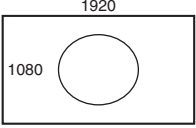
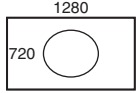
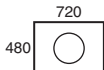
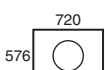
DVI format	Mode	HD/1080i	HD/720P	SD/NTSC	SD/PAL
		1920 × 1080	1280 × 720	720 × 480	720 × 576
WSXGA+ 1680 × 1050 	Fit-V				
	Fit-H				
	Full				
UXGA 1600 × 1200 	Fit-V				
	Fit-H				
	Full				
WUXGA 1920 × 1200 	Fit-V				
	Fit-H				
	Full				

: Black images are inserted here.

: The parts of the images protruding in these areas are cropped.

4. Input/output signal settings

4-2-2. Adjusting the DVI input signals

Adjust the clock/phase and position of the DVI-I input signals.

- ① Press the [INPUT] button to light its indicator and display the INPUT menu.
☞ Refer to “2-1-5. LCD menu area”.
- ② Turn [F1] to display the INPUT XX sub menu.
(X: A1, A2, B1 or B2)
The input used to set the clock phase and position is selected for X.
- ③ Turn [F2] to display the third menu of DVIPhs.

<Menu display>

INPUT XX	DVIPhs	ClkPhs	H-Pos	V-Pos
	4/4	0	0	0
		-16	-100	-100
		15	100	100

- ④ Turn [F3] to adjust the clock phase of the analog input signals using the ClkPhs item.
While viewing the image quality, set the value at which the noise level is minimized.
- ⑤ Turn [F4] to adjust the horizontal position using the H-Pos item.
- ⑥ Turn [F5] to adjust the vertical position using the V-Pos item.

4. Input/output signal settings

4-3. Setting the output signals

OUT1 to OUT4 are SDI signal outputs.

OUT5 and OUT6 are DVI-D signal outputs.

OUT A1, OUT A2, OUT B1 and OUT B2 can be set only when one of the following option boards has been connected.

- AV-HS04M4 (Analog Output Board)
- AV-HS04M5 (DVI/Analog Output Board)
- AV-HS04M7 (SDI Output Board)

<List of settings by output signal>

Output connector		Setting menu and numbers of sections in this manual			
		Assign	DVIOut (Dig)	DVIOut (Ana)	DownCnv
		4-3-1	4-4	4-4	4-5
OUT1 to OUT4	Standard SDI output ×4 lines	✓	—	—	—
OUT5, OUT6	Standard DVI-D output ×2 lines	✓	✓	—	—
Option slot OUT A1, OUT A2, OUT B1, OUT B2	AV-HS04M4 Analog component output ×2 lines	✓	—	—	—
	AV-HS04M5 DVI-I output ×1 line Analog component output ×1 line	✓	✓	✓	—
	AV-HS04M7 SDI output ×2 lines	✓	—	—	✓

✓: Can be set.
—: Cannot be set.

4. Input/output signal settings

4-3-1. Assigning the output signals

Assign the output signals to OUTPUT1 to OUTPUT10.

- ① Press the [OUTPUT] button to light its indicator and display the OUTPUT menu.
☞ Refer to “2-1-5. LCD menu area”.
- ② Turn [F1] to display the OUTPUTYY sub menu.
(Y: OUT1 to OUT6, A1, A2, B1 or B2)
The output used to assign the output signal is selected for Y.
- ③ Turn [F2] to display the Assign sub menu.

<Menu display>

OUTPUTYY	Assign	Source	Mode↓	
	1/2	PGM	*Normal	
		PVW	DC	
		CLN		
		AUX1~4		
		MV1, MV2		
		KeyOut		

- ④ Turn [F3] to set the type of output signal using the Source item.
 - PGM:** An image provided with the wipe, mix, key, downstream key or other effect is output at the switcher's main line output.
 - PVW:** This is the preview output that enables the next operation to be checked before it is executed.
 - AUX 1 to 4:** The signals selected by the AUX bus in lines 1 to 4 are output.
 - CLN:** The clean signal (the image resulting when the key, downstream key or other effect has been removed from the PGM signal) is output.
☞ Refer to “Assigning the CLN signal”.
 - MV 1, MV 2:** The multi view display signals in two lines are output.
Multiple input signals and output signals are reduced in size and output to one screen.
 - KeyOut:** The key signal is output.

4. Input/output signal settings

- ⑤ When the SDI output board (option) has been connected, turn [F4] to set the output mode using the Mode item, and press the [F4] switch to enter the setting.

An asterisk (*) appears on the left of the currently selected output mode.

Normal: The same signals as the system format signals are output.

DC (down-converter):

When the system format is 1080/59.94i or 720/59.94p, the signals are output in the 480/59.94i format.

When the system format is 1080/50i or 720/50p, the signals are output in the 576/50i format.

When the system format is SD (480/59.94i or 576/50i), this setting cannot be selected.

Assigning the CLN signal

Set KEYCLN, DSK1CLN or DSK2CLN as the CLN output.

- ① Press the [CONFIG] button to light its indicator and display the CONFIG menu.

☞ Refer to “2-1-5. LCD menu area”.

- ② Turn [F1] to display the CLNAssign sub menu.

<Menu display>

CONFIG12	CLN			
CLNAssign	KEY			
	DSK1			
	DSK2			

- ③ Turn [F2] to select the type of output signal using the CLN item.

4. Input/output signal settings

4-4. Setting the DVI output signals (OUT5 and OUT6 standard outputs and options)

Set the DVI output signals of the OUT5 and OUT6 standard outputs and the DVI output signals if the DVI/analog output board (option) has been connected.

- ① Press the [OUTPUT] button to light its indicator and display the OUTPUT menu.
 ☞ Refer to “2-1-5. LCD menu area”.
- ② Turn [F1] to display the OUTPUTYY sub menu.
 (Y: OUT5, OUT6, A1, A2, B1 or B2)
 The output that supports the DVI signal is selected for Y.
- ③ Turn [F2] to display the third menu of DVIOut.

<Menu display>

OUTPUTYY	DVIOut	Mode	Size↓	Scale↓
	2/2	*Dig	*Auto	*Fit-V
		Ana	XGA WXGA SXGA WSXGA+ UXGA WUXGA	Fit-H Full

- ④ Turn [F3] to select the signal system using the Mode item, and press the [F3] switch to enter the selection.
 - Set this when the DVI/analog input board (AV-HS04M5) has been connected.
 - Dig:** DVI digital signals are output from the DVI connector.
 - Ana:** DVI analog signals (RGB) are output from the DVI connector.
 When “Ana” has been selected, the display position of the image may be off depending on the monitor which is connected. If it is off, adjust the position at the monitor.
 For details on the adjustment method, refer to the operating instructions of the monitor.
- ⑤ Turn [F4] to select the resolution of the images to be output, and press the [F4] switch to enter the selection.
 - Auto:** The equipment information of the output destination is captured by the DVI signals, and the images are output at the optimum resolution. (The vertical frequency is 60 Hz, and the maximum resolution is SXGA for analog output signals and WUXGA for digital output signals.)
 If the equipment information cannot be captured or if the resolution and frequency which can be output by the product are not contained in the equipment information, the images will be output at the XGA setting.
 - XGA:** The images are output at the 1024×768 resolution and 60 Hz frequency.
 - WXGA:** The images are output at the 1280×768 resolution and 60 Hz frequency.
 - SXGA:** The images are output at the 1280×1024 resolution and 60 Hz frequency.
 - WSXGA+:** The images are output at the 1680×1050 resolution and 60 Hz frequency.
 (This can be selected only when digital signals are output.)
 - UXGA+:** The images are output at the 1600×1200 resolution and 60 Hz frequency.
 (This can be selected only when digital signals are output.)
 - WUXGA:** The images are output at the 1920×1200 resolution and 60 Hz frequency.
 (This can be selected only when digital signals are output.)
 - 1080/59.94P:** The images are output at the 1920×1080 resolution and 59.94 Hz frequency.
 (Only OUT5 and OUT6 can be selected.)
 - 1080/50P:** The images are output at the 1920×1080 resolution and 50 Hz frequency.
 (Only OUT5 and OUT6 can be selected.)

4. Input/output signal settings

⑥ Turn [F5] to select the scaling method, and press the [F5] switch to enter the selection.

- Fit-V:** The aspect ratio of the output images is maintained, and the size of the images is increased or reduced in accordance with the vertical resolution.
(Black bands are inserted into the areas where there are no images. The protruding parts of the images are cropped.)
- Fit-H:** The aspect ratio of the output images is maintained, and the size of the images is increased or reduced in accordance with the horizontal resolution.
(Black bands are inserted into the areas where there are no images. The protruding parts of the images are cropped.)
- Full:** The size of the output images is increased or reduced in accordance with the system resolution.
(The aspect ratio of the output images is not maintained. The rate at which the image size is increased or reduced in the vertical direction differs from that in the horizontal direction.)

■ Select the settings below in cases where DVI-D signals (OUT5 and OUT6) are output.

⑦ Turn [F2] to display the Assign sub menu.

<Menu display>

OUTPUTYY	Assign	Source	MovDet↓
	1/2	PGM	*3
		PVW	1~5
		CLN	
		AUX1~4	
		MV1, MV2	
		KeyOut	

⑧ Turn [F4] to set the video movement detection sensitivity using the MovDet item, and press the [F4] switch to enter the setting.

1: Sensitivity closer to still image — **3:** standard — **5:** sensitivity closer to moving images

4. Input/output signal settings

4-5. Setting the down-converter (option)

Select the settings for the down-converter that is built into the SDI output board (option).

- ① Press the [OUTPUT] button to light its indicator and display the OUTPUT menu.

☞ Refer to “2-1-5. LCD menu area”.

- ② Turn [F1] to display the OUTPUTYY sub menu.
(Y: Out1 to Out4, A1, A2, B1 or B2)

The output signal to be converted is selected for Y.

- ③ Turn [F2] to display the third menu of DownConv.

- ④ Turn [F3] to select the scaling system using the Scale item, and press the [F3] switch to enter the setting.

<Menu display>

OUTPUTYY	DownCnv	Scale↓	Delay↓	Sharp↓
	2/2	*SQ	*90H	*3

EC	1F	1~5
LB		

SQ (squeeze):

The top, bottom, left and right are reduced so that the aspect ratio is set to 4:3.

EC (edge crop):

The aspect ratio is maintained, the image is reduced in size in line with the vertical resolution, and it is cropped at the left and right.

LB (letter box):

The aspect ratio is maintained, the image is reduced in size in line with the horizontal resolution, and a black image is added at the top and bottom.

System image (HD)	Output image (SD)		
	SQ	EC	LB

- ⑤ Turn [F4] to set the delay time of the output using the Delay item, and press the [F4] switch to enter the setting.

90H (75H): When the system format is 1080/59.94i, the image is delayed from the system image (HD) by 90H, and output.

When the system format is 720/59.94p, the image is delayed from the system image (HD) by 90H+1F (frame), and output.

When the system format is 1080/50i, the image is delayed from the system image (HD) by 75H, and output.

When the system format is 720/50p, the image is delayed from the system image (HD) by 75H+1F (frame), and output.

When the system format is 1080/50i or 720/50p, “75H” is displayed on the menu.

1F: The image is output in-phase with a delay of 1 frame from the system image (HD).

For details on the phase and delay amounts, refer to “4-7. Adjusting the output signal phase”.

- ⑥ Turn [F5] to set the degree of sharpness of the edges for the image using the Sharp item, and press the [F5] switch to enter the setting.

1: Standard up to **5:** sharper edges

For details on the other settings, refer to the operating instructions of the optional board.

4. Input/output signal settings

4-6. Setting the sync signals

The sync signals to be used by the system can be selected.

External sync: For synchronization with an external sync signal (gen-lock).

The reference input signal is looped through and output.

BBST: Black burst signal (vertical phase of 0H)

BBAD: Black burst signal

Vertical phase of 90H when the 59.94i or 59.94p format is selected;
vertical phase of 75H when the 50i or 50p format is selected

TRI: Tri-level sync signal (vertical phase of 0H)

This can be selected when HD format signals are supplied.

Internal sync: For synchronization with an internal reference signal (INT).

The REFOUT signal (black burst signal) is output from the two reference connectors.

① Press the [SYSTEM] button to light its indicator and display the SYSTEM menu.

 Refer to “2-1-5. LCD menu area”.

② Turn [F1] to display the Ref sub menu.

<Menu display>

SYS	3	Sync↓	BBSetup	GenLock	
Ref		*BBST	7.5IRE	-	
		BBAD	0IRE	Locked	
		TRI		UnLock	
		INT			

③ Turn [F2], select the sync signal using the Sync item, and press the [F2] switch to enter the selection.

An asterisk (*) appears at the left of the reference signal currently selected.

④ Turn [F3] to select the setup level of the black burst signal in the internal synchronization mode using the BBSetup item.

This setting takes effect when the video system is 59.94i or 59.94p.

The setup level is fixed at 0 IRE when the system is 50i or 50p.

⑤ The genlock status is displayed in the GenLock item.

Locked: Synchronized with the external sync signal or internal reference signal.

UnLock: Not synchronized with the external sync signal or internal reference signal.

- When 1080/23.98PsF or 24PsF is selected as the format, INT (internal synchronization) cannot be selected in the SYNC item of the REF sub menu.
- This unit supports synchronization signals for field frequencies that are same as those of the system format. When the unit is set to the 1080/23.98PsF format, however, the unit also supports black burst signals with 10F-1D (compliant with the SMPTE318M standard).

4. Input/output signal settings

4-7. Adjusting the output signal phase

The phase of the output video signals can be adjusted.

- ① Press the [SYSTEM] button to light its indicator and display the SYSTEM menu.
☞ Refer to “2-1-5. LCD menu area”.

- ② Turn [F1] to display the OutPhs sub menu.

<Menu display>

SYS	2	System	H-Phase	V-Phase
OutPhs		1H	0	0
		0H	-1320	-100
			+1319	+100

- ③ Turn [F2], and select 0H or 1H using the System item.

0H: The output video signals are output to the system REF signal with using in-phase.
The frame synchronizer function is ON for all input signals.

1H: The output video signals are output to the system REF signal with 1H delay.

When the frame synchronizer function is ON, the output video signals are output with 1 frame + 1H delay.

- ④ Turn [F3] to adjust H phase using the H-Phase item.

H-Phase can be adjusted within a range of $-0.5H$ to $+0.5H$.

- The setting displayed on the menu differs depending on the video format.

- ⑤ Turn [F4] to adjust V phase using the V-Phase item.

V-Phase can be adjusted within a range of $-100H$ to $+100H$.

4. Input/output signal settings

<Phase adjustment setup>

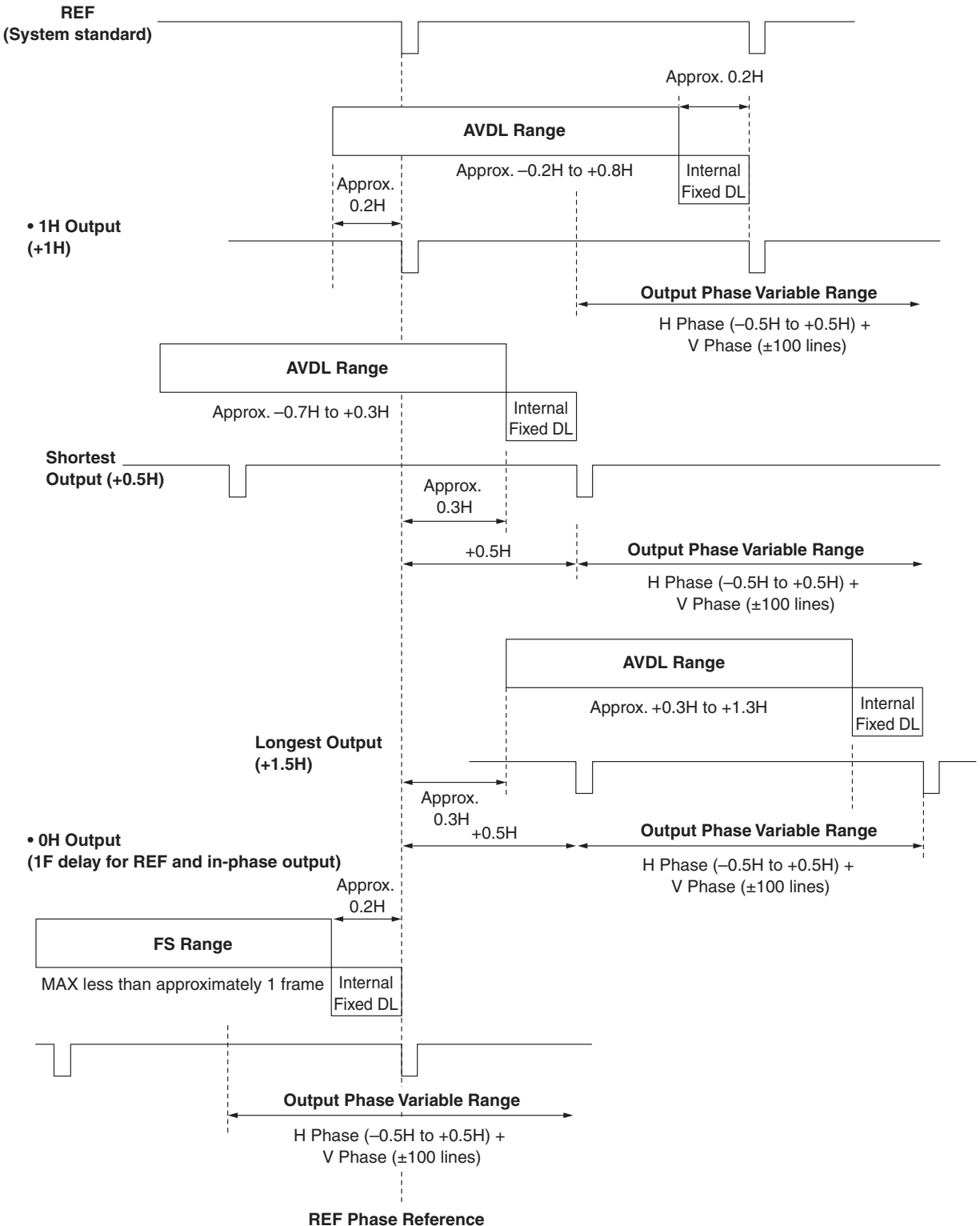

AVDL Range: Range for automatic phase adjustment.

4. Input/output signal settings

<Phases and delay amounts of input/output signals during HD format use>

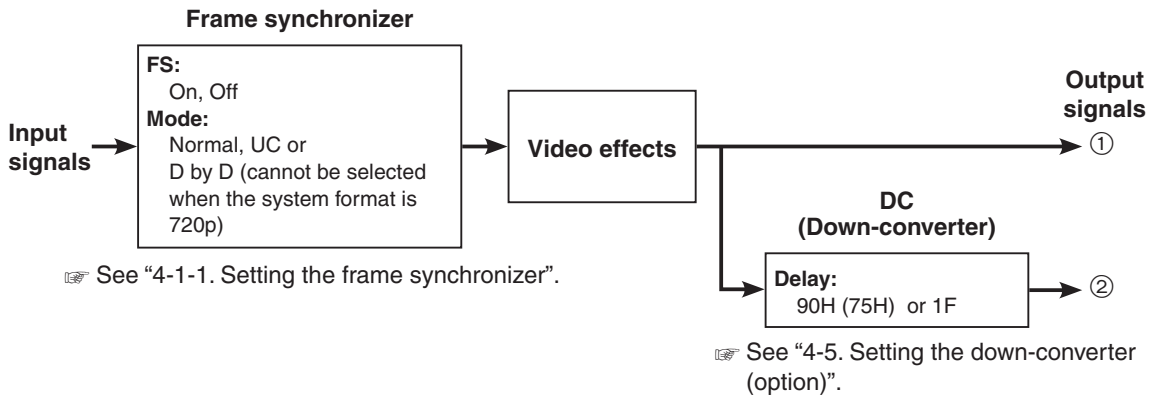

OutPhs	Input		Non-synchronized input	Output signal ① Normal		Output signal ② DC (90H)		Output signal ② DC (1F)	
	System	Mode		FS	Phase	Delay amount	Phase	Delay amount	Phase
Sync signal (Ref): Black burst signal (BBST), tri-level sync signal (TRI), internal reference signal (INT)									
1H	Normal	Off	Not possible	Ref+1H	1H	①+90H	1H+90H	In-phase with ①	1H+1F
	Normal	On	Possible	Ref+1H	Max. 1F+1H	①+90H	Max. 1F+1H+90H	In-phase with ①	Max. 2F+1H
	UC/D by D	On (Forced)	Possible						
0H (Example 1)	Normal/UC/D by D	On (Forced)	Possible	In-phase with Ref	Max. 1F	①+90H	Max. 1F+90H	In-phase with ①	Max. 2F
Sync signal (Ref): Black burst signal (BBAD)									
1H	Normal	Off	Not possible	Ref-90H+1H	1H	①+90H	1H+90H	In-phase with ①	1F+1H
	Normal	On	Possible	Ref-90H+1H	Max. 1F-90H+1H	①+90H	Max. 1F+1H	In-phase with ①	Max. 2F-90H+1H
	UC/D by D	On (Forced)	Possible						
0H (Example 2)	Normal/UC/D by D	On (Forced)	Possible	Ref-90H	Max. 1F-90H	①+90H (In-phase with Ref)	Max. 1F	In-phase with ①	Max. 2F-90H

- For 1080/50i and 720/50p, the 90H indicated above becomes 75H.
- Conversion based on the HD format applies for 1H.
- When DVE effect, IMAGE effect and PinP effect have been used as the video effects, the output signal is delayed by +1F.
- The phase and delay amount for the DVI input signals are the same as when UC/D by D is selected since the frame synchronizer is set to the On mode.
- The DVI output signals are delayed by +1F.
- When images are output to a multi view display, they are delayed by +1F.
- When DVI output signals are output images for a multi view display, the output images are delayed by +2F.

4. Input/output signal settings

<Phase relationship between input signals and output signals> (for 1080/59.94i format)

(Example 1)

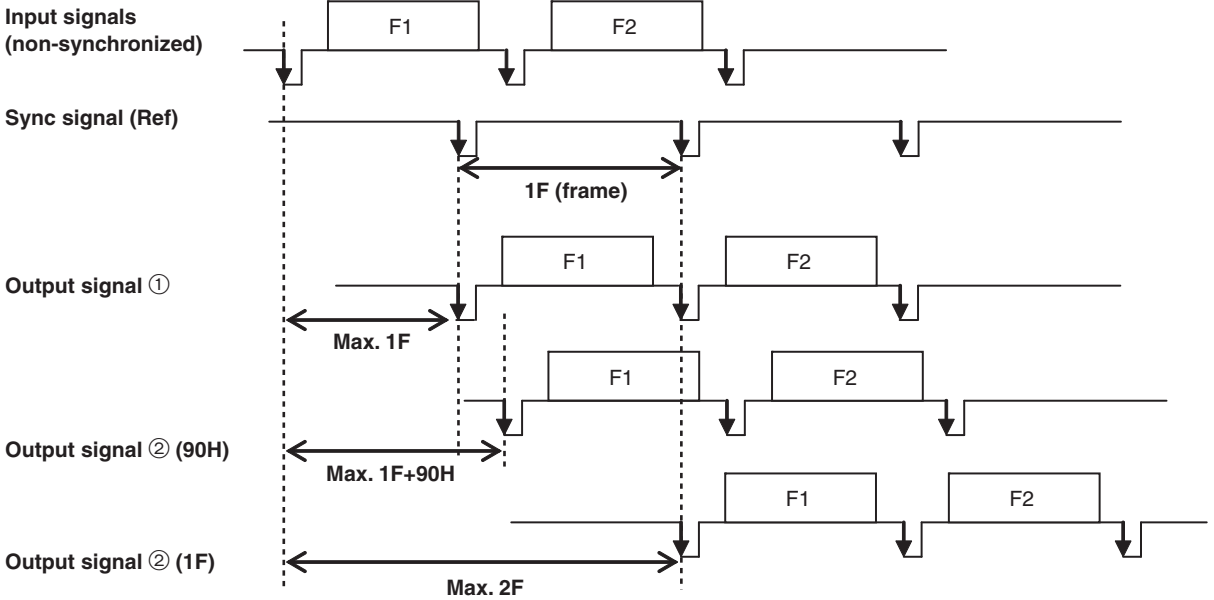

(Example 2)

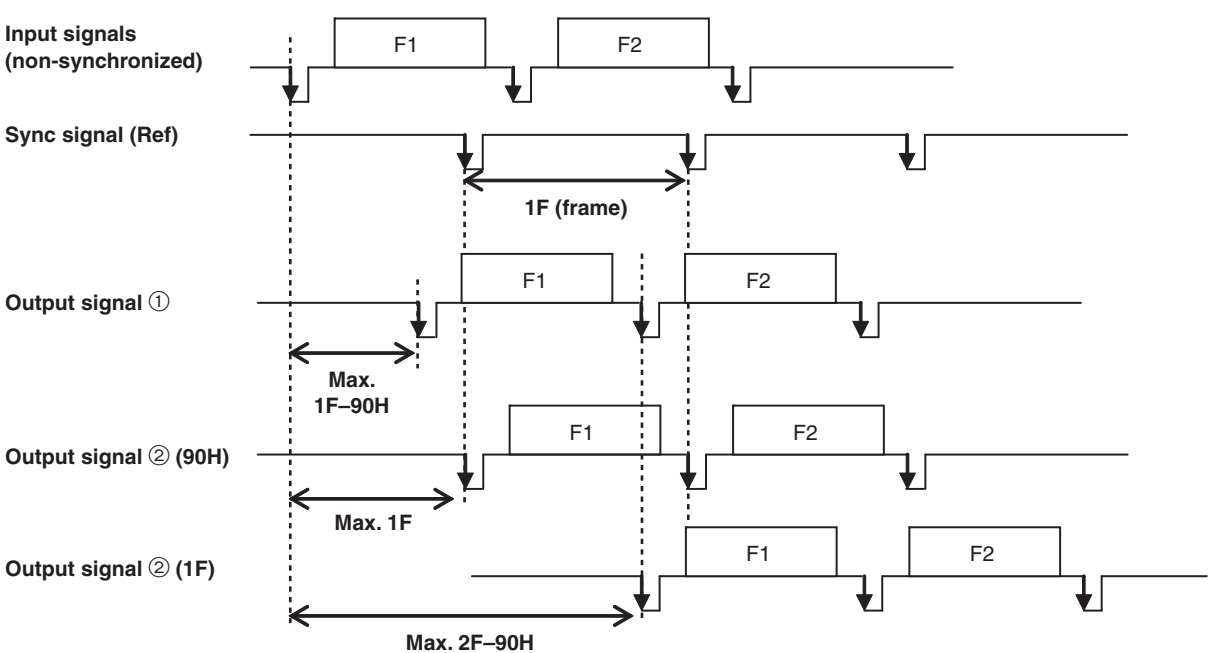

4. Input/output signal settings

4-8. Setting the multi view display

The input images, program images, preview images, etc. can be arranged on the screen of an external monitor and output to two lines (MV1 and MV2).

4-8-1. Setting the screen layout

There are four multi view split-screen display modes: 16 split (the main screen is split into 16 subscreens), 10 split, 9 split and 4 split.

Inputs 1 to 20, CBGD, CBAR, FMEM1 to 4, PGM, PVW, AUX1-4 and KeyOut can be assigned to subscreens ① to ⑩.

A total of up to 20 subscreens for display as split screens can be set for MV1 and MV2.

(If MV1 is set to 16 split, MV2 will be set to the 4 split mode, and it is not possible to set the mode to 9 split or above.)

<Display modes>

16-division mode (16Split):

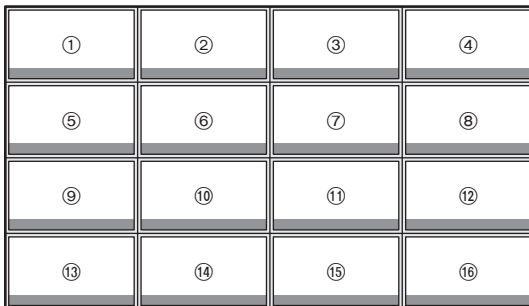

10-division mode (10Split):

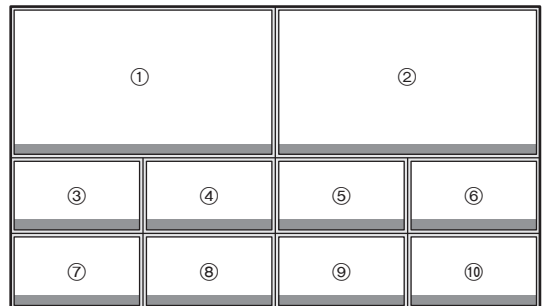

9-division mode (9Split):

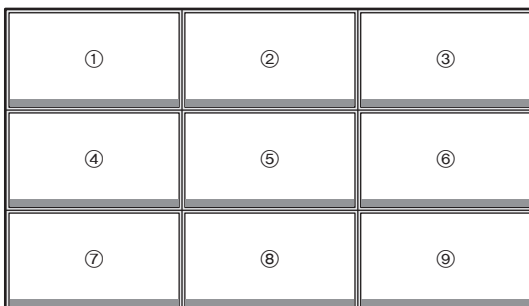

4-division mode (4Split):

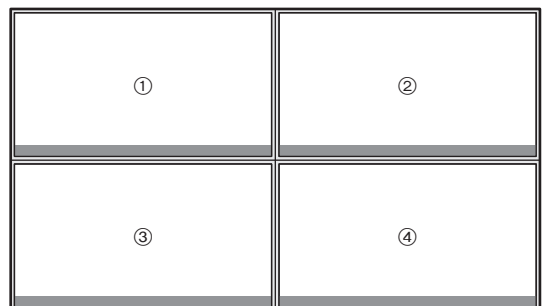

4. Input/output signal settings

- ① Press the [MV] button to light its indicator and display the MV menu.
 ☞ Refer to “2-1-5. LCD menu area”.

- ② Turn [F1] to select the MV1 PATT or MV2 PATT sub menu depending on the multi view output signals to be set.

<Menu display>

MV	1	Split	Pos	Signal
MV1 PATT	10	Split	1	PGM
		16Split	1~10	IN1~16
		9Split		IN-A1
		4Split		IN-A2
				IN-B1
				IN-B2
				CBGD
				FMEM1~4
				PVW
				KeyOut
				AUX1~4

- ③ Turn [F2] to set the split-screen display mode using the Split item.

- ④ Turn [F4] to set the subscreens (① to ⑩) using the Pos item.

- ⑤ Turn [F4] to set the names of the signals to be displayed on the subscreens using the Signal item.

- When AUX1 to AUX4 have been selected, the signal names listed below will be displayed on the LCD for the signals selected as the AUX output signals.

☞ Refer to “3-9-1. Selecting the AUX output materials”.

Name of signal	Display on LCD	Name of signal	Display on LCD
IN1 to 20	[IN1] to [IN20]	KeyOut	[KeyOut]
PGM	[PGM]	FMEM1 to 4	[FM1] to [FM4]
PVW	[PVW]	CBGD	[CBG]
CLN	[CLN]	CBAR	[BAR]
MV1, MV2	[MV1], [MV2]		

- If, when AUX2 to AUX4 have been selected, the multi view display output (MV1 or MV2) is selected for the AUX bus (AUX2, AUX3, AUX4) output signal, the images of the AUX bus displayed on the subscreens of the multi view display will be black images.

4. Input/output signal settings

4-8-2. Setting the split frame and characters

Set the frame, character brightness and background of the split screens to be displayed on the multi view display.

- Press the [MV] button to light its indicator and display the MV menu.
 ☞ Refer to “2-1-5. LCD menu area”.

- Turn [F1] to select the MV1 Frame or MV2 Frame sub menu depending on the multi view output signals to be set.

<Menu display>

MV	2	Frame	Char	Label	Tally
MV1Frame	LUM75%	LUM75%		On	Red+GRN
	LUM 0%	LUM 0%	Off		Red
	LUM25%	LUM25%			Off
	LUM50%	LUM50%			
	LUM100%	LUM100%			
	Off	Off			

MV	4	Frame	Char	Label	Tally
MV2Frame	LUM75%	LUM75%		On	Red+GRN
	LUM 0%	LUM 0%	Off		Red
	LUM25%	LUM25%			Off
	LUM50%	LUM50%			
	LUM100%	LUM100%			
	Off	Off			

- Turn [F2] to set the split frame brightness and split frame display using the Frame item.

LUM (0%, 25%, 50%, 75%, 100%):

Select one of these settings for the brightness of the split frame (gray scale).

Off: The split frame is not displayed.

- Turn [F3] to set the character brightness and character display using the Char item.

LUM (0%, 25%, 50%, 75%, 100%):

Select one of these character (gray scale) brightness settings.

- The “!” mark appears in front of the name of the material when no signals are input or signals with a different format are input.
- When signals amenable to camera control have been input, the “c” mark is displayed in front of the name of the material.
- When the input signal is frozen, the “F” mark is displayed in front of the name of the material.
- When the “!” mark is displayed, the “c” mark will not be displayed.
- When the “F” mark is displayed, the “!” mark and the “c” mark are not displayed.

Off: The characters are not displayed. Neither is the character background shown.

- Turn [F4] to set whether the character background (half-tone) is to be displayed using the Label item.

On: The character background is displayed.

Off: The character background is not displayed.

4. Input/output signal settings

4-8-3. Setting the tally displays

Set the tally displays to be superimposed onto the split frame of the multi view display.

The red tally indicates material consisting of program outputs.

The green tally indicates material selected by the preset bus.

On the MV1 Frame or MV2 Frame sub menu, turn [F5] to set the tally displays using the Tally item.

<Menu display>

MV	2	Frame	Char	Label	Tally
MV1Frame	LUM75%	LUM75%	On	Red+GRN	

LUM 0%	LUM 0%	Off	Red
LUM25%	LUM25%		Off
LUM50%	LUM50%		
LUM100%	LUM100%		
Off	Off		

MV	4	Frame	Char	Label	Tally
MV2Frame	LUM75%	LUM75%	On	Red+GRN	

LUM 0%	LUM 0%	Off	Red
LUM25%	LUM25%		Off
LUM50%	LUM50%		
LUM100%	LUM100%		
Off	Off		

Red+GRN: Both the red tally and green tally are displayed.

Red: Only the red tally is displayed.

Off: No tally displays are shown.

- The red tally is not displayed during FTB operation while the program images have been completely faded out to a black screen. At this time, the green tally is displayed for images consisting of program images.
- The red tally and green tally signals are output from the tally output connector on the rear panel.

☞ Refer to "5-7-3. Setting the GPI".

4. Input/output signal settings

4-8-4. Changing the material names

Change the names of the INPUT1 to 20 materials that are to be set on the multi view display.

The default settings, preset settings or user settings can be selected for these names.

When the preset settings and user settings are established, the material name (CAM1, etc.) display format is used.

- Press the [INPUT] button to light its indicator and display the INPUT menu.

☞ Refer to “2-1-5. LCD menu area”.

- Turn [F1] to display the INPUT XX sub menu.
(X: IN1 to IN16, A1, A2, B1 or B2)

The signal with the material whose name is to be changed is selected for X.

- Turn [F2] to display the Name sub menu.

- Turn [F3] to select the type of material name using the Type item, and press the [F3] switch to enter the type. An asterisk (*) appears at the left of the type of material name currently selected.

Default: The default settings for INPUT1 to INPUT16, INPUTA1, INPUTA2, INPUTB1 and INPUTB2 are selected.

Preset: The material names and number provided ahead of time are selected.

User: The material names are set using 7 characters.

If the Type item setting is changed when “Preset” or “User” is selected, the previously provided material names will be lost.

<Menu display>

INPUT XX	Name	Type↓		
	3/13	*Default		

Preset
User

Preset type setting procedure

- On the Name sub menu, turn [F3] to select “Preset” using the Type item.
- Turn [F4] to select the material name using the Name item.
- Turn [F5] to select the material number using the NO. item, and press the [F5] switch to enter the number.

<Menu display>

INPUT XX	Name	Type↓	Name	NO. (*)↓
	3/13	*Preset	CAM*	1

C*	1~9
CG*	
CGV*	
CGK*	
PC*	
V*	
VTR*	
VCR*	

User type setting procedure

- On the Name sub menu, turn [F3] to select “User” using the Type item.
- Turn [F4] to move the “■” cursor to the position of the character to be changed using the Name item.
- Turn [F5] to select the character, and press the [F5] switch to enter it.
- Set all the characters in the material name by repeating steps ② and ③.

<Menu display>

INPUT XX	Name	Type↓	Name	(■)↓
	3/13	*User	■AM8	C

4. Input/output signal settings

4-8-5. High-resolution multi view mode

When the system mode is set to SD, the DVI-D output can be output in high resolution.

If this is the case, MV1 is set for OUT5, and MV2 for OUT6.

MV1 and MV2 cannot be set for any other outputs.

● These settings can be established when SD serves as the system mode.

① Press the [SYSTEM] button to light its indicator and display the SYSTEM menu.

☞ Refer to “2-1-5. LCD menu area”.

② Turn [F1] to display the Format sub menu.

<Menu display>

SYS	1	Mode↓	HiRes↓	16:9SQ
Format		*1080/59.94i	* Off	Off
		1080/50i	On	On
		1080/24psf		
		1080/23.98psf		
		720/59.94p		
		720/50p		
		480/59.94i		
		576/50i		

③ Turn [F4] to set On or Off using the HiRes item, and press the [F4] switch.

4. Input/output signal settings

4-9. Setting the on-screen display (OSD)

The menu screen can be superimposed onto the preview output or multi view display 1 or 2 output for display.

- ① Press the [CONFIG] button to light its indicator and display the CONFIG menu.
- ② Turn [F1] to display the OSD sub menu.
- ③ Turn [F2] to set whether to display the OSD using the OSD item.

<Menu display>

CONFIG10	OSD	Select		
OSD	On	PVW		
	Off	MV1		
		MV2		
		MV1+MV2		

On: OSD is displayed.

Off: OSD is not displayed.

This function can be assigned to a user button. ☞ See “5-3-1. Setting the user buttons”.

- ④ Turn [F3] to set the output destination using the Select item.

PVW: The menu screen is superimposed onto the preview output, and output.

MV1: The menu screen is superimposed onto multi view display output 1, and output.

MV2: The menu screen is superimposed onto multi view display output 2, and output.

MV1+2: The menu screen is superimposed onto both multi view display outputs 1 and 2, and output.

- When On is selected as the OSD item setting, the multi view display split frame are not displayed on the monitor.

■ Examples of OSD displays

“>” appears to the left of the selected menu.

This indicates the wipe pattern for the background transition.

This indicates the wipe pattern for the key transition.

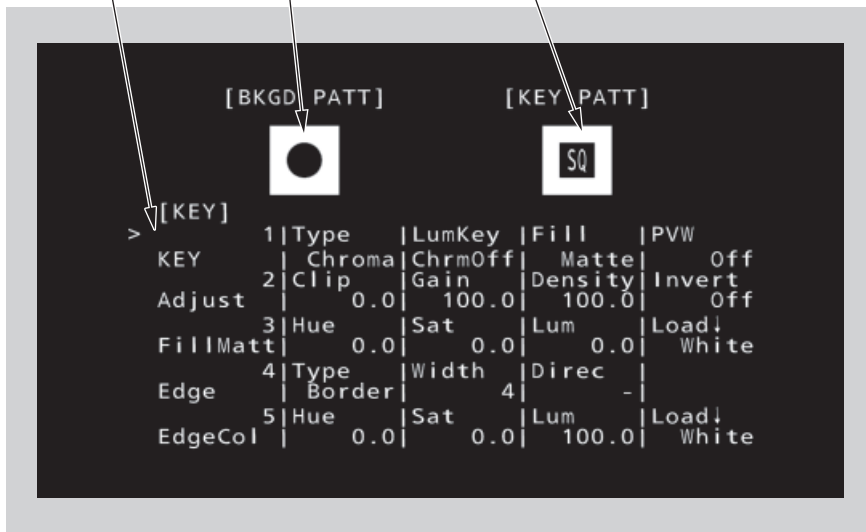

4. Input/output signal settings

4-10. Setting the ancillary data

In this section, the function for allowing the ancillary data of the SDI input signals to pass through is set. If SD format signals are input while the HD format has been set as the system format, it will not be possible for their ancillary data to be passed through.

Setting the V ancillary data

It is possible to decide whether to allow the V ancillary data, which is superimposed in the vertical blanking period of the input images, to pass through the PGM bus. The background bus data which is output to program (PGM) is passed through for images whose transition has been cut off. During a transition, the background bus data which was output to program (PGM) immediately before is passed through.

- ① Press the [SYSTEM] button to light its indicator and display the SYSTEM menu.
☞ Refer to “2-1-5. LCD menu area”.
- ② Turn [F1] to display the Anci sub menu.

<Menu display>

SYS	4	VAnci	E.Audio		
Anci		Off	Off		
		On	On		

- ③ Turn [F2] to select On or Off for the V ancillary data using the VAnci item.
On: In the case of the HD format, the ancillary data starting with line 10 is passed through.
In the case of the SD format, the ancillary data starting with line 14 is passed through.
Off: The data is not passed through.

Setting the embedded audio data

The embedded audio data of the SDI input signals can be passed through the AUX bus.

- ① On the Anci sub menu, turn [F3] to select On or Off for the embedded audio data using the E.Audio item.

<Menu display>

SYS	4	VAnci	E.Audio		
Anci		Off	Off		
		On	On		

- On:** The data is passed through.
- Off:** The data is not passed through.

When “On” has been selected, the V ancillary data of the input images is also passed through at the same time.

5. System settings

5-1. Selecting the video format

One system (input/output signal) video format can be selected.

- ① Press the [SYSTEM] button to light its indicator and display the SYSTEM menu.
☞ Refer to “2-1-5. LCD menu area”.
- ② Turn [F1] to display the Format sub menu.

<Menu display>

SYS	1	Mode↓	HiRes↓	16:9SQ
Format		*1080/59.94i	* Off	Off
		1080/50i	0n	0n
		1080/24psf		
		1080/23.98psf		
		720/59.94p		
		720/50p		
		480/59.94i		
		576/50i		

- ③ Turn [F2], select the format using the Mode item, and press the [F2] switch to enter the selection.
An asterisk (*) appears at the left of the format currently selected.

Setting the 16:9 squeeze mode

When the 16:9 squeeze mode is selected, a border width (wipe or PinP) is established that considers cases where SD format images are to be converted into the 16:9 aspect ratio and used.

This setting is possible when SD is selected as the system format setting.

On the Format sub menu, turn [F5] to select whether to support the squeeze mode using the 16:9SQ item.

- On:** The squeeze mode is supported.
- Off:** The squeeze mode is not supported.

Border width (graphical representation) when the squeeze mode is supported

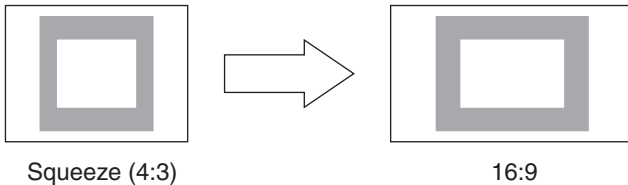

5. System settings

5-2. Setting the crosspoints

5-2-1. Assigning signals to the crosspoints

External video input signals and internally generated signals can be assigned to crosspoint buttons 1 to 32.

Displaying the assignment statuses

- ① Press the [XPT] button to light its indicator and display the XPT menu.
 Ⓜ Refer to “2-1-5. LCD menu area”.
- ② Turn [F1] to display the Stats1-4 sub menu.
 The status of the assignment is displayed. The names of the assigned signals are abbreviated on the display.

<Menu display>

XPT	1	XPT :	1	2	3	4	5	6	7	8
Stats1		SIG :	BK	1	2	3	4	5	6	7

When one of the crosspoint buttons 1 to 32 is held down for a long time, the name of the signal assigned is displayed on the LCD while the button is held down.

Example: When crosspoint button 1 is pressed (when the INPUT1 signal has been assigned to this button)

XPT	1	XPT :	1
Stats1		SIG :	IN1

“SHIFT” will be displayed for XPT16 when the SHIFT function has been assigned to the crosspoint 16 button.

Assigning signals to the crosspoints

- ① Press the [XPT] button to light its indicator and display the XPT menu.
 Ⓜ Refer to “2-1-5. LCD menu area”.
- ② Turn [F1] to display the XPTAsign sub menu.
- ③ Turn [F2], select the crosspoint button using the XPT item, turn [F3] and select the input signal using the Signal item.
 Changing the current assignment of the signals selected by the crosspoint buttons will cause the positions of the lighted crosspoint buttons to change to correspond with the assignment change. The images output at this time will remain unchanged.

<Menu display>

XPT	5	XPT	Signal	Shift	Sf-Lock
XPTAsign		-	-	Right	Off
	1~32	IN1~16		Off	On
		IN-A1		Left	
		IN-A2			
		IN-B1			
		IN-B2			
		Black			
		CBGD			
		CBAR			
		FMEM1~4			
		PGM			
		PVW			
		KeyOut			
		CLN			
		MV1, MV2			
		NoAsign			

5. System settings

The table below lists the materials which can be assigned.

Button	Signal	Description
XP1 to 32	IN1 to IN16	SDI input 1 to 16
	IN-A1, IN-A2, IN-B1, IN-B2	Option slot (SDI, Analog component, analog composite and DVI)
	Black	Internally generated signal, black
	CBGD	Internally generated signal, color background
	CBAR	Internally generated signal, color bar
	FMEM1 to FMEM4	Frame memory image
	CLN	CLN (AUX only)
	PVW	PVW (AUX only)
	PGM	PGM (AUX only)
	KeyOut	KeyOut (AUX only)
	MV1	MV1 (AUX only)
	MV2	MV2 (AUX only)
	NoAsign	No assignment

- The image will not be changed by pressing any button to which “NoAsign” is assigned.
- If the multi view display output (MV1 or MV2) is selected as the AUX bus (AUX2, AUX3, AUX4) output signal when the AUX2 to AUX4 output signals have been assigned for the multi view display output (MV1 or MV2), a black image will be displayed as the image of the AUX bus that appears on the subscreen of the multi view display.

The table below lists the default settings.

Button	Signal	Button	Signal	Button	Signal	Button	Signal
XP1	BLACK	XP9	IN8	XP17	IN15	XP25	—
XP2	IN1	XP10	IN9	XP18	IN16	XP26	PGM
XP3	IN2	XP11	IN10	XP19	IN-A1	XP27	PVW
XP4	IN3	XP12	IN11	XP20	IN-A2	XP28	KeyOut
XP5	IN4	XP13	IN12	XP21	IN-B1	XP29	CLN
XP6	IN5	XP14	IN13	XP22	INB2	XP30	MV1
XP7	IN6	XP15	IN14	XP23	—	XP31	MV2
XP8	IN7	XP16	Shift	XP24	—	XP32	Shift

5. System settings

5-2-2. Setting the crosspoint switching

The timing at which the crosspoints are to be switched can be set.

- ① Press the [XPT] button to light its indicator and display the XPT menu.
☞ Refer to “2-1-5. LCD menu area”.
- ② Turn [F1] to display the XPTSwch sub menu.

<Menu display>

XPT	6	Timing			
XPTSwch		Any			
		Field1			
		Field2			

- ③ Turn [F2], and select the switching timing using the Timing item.
 - Any:** The crosspoints are switched in the nearest field. This is suited to live applications.
 - Field1:** The crosspoints are switched in field 1. This is suited to editing applications.
 - Field2:** The crosspoints are switched in field 2. This is suited to editing applications.

5. System settings

5-3. Button assignments

5-3-1. Setting the user buttons

The user can assign several functions which can be set using the menu items into six user buttons (USER 1 to USER 6).

The user buttons light in amber when the assigned function is ON and are off when the assigned function is OFF. Each time the user button is pressed, the function setting alternates between ON and OFF.

The table below lists the functions which can be assigned to the user buttons (USER 1 to USER 6).

No.	Function name	Description of function
1	PinPPVW	Outputs the PinP1 and PinP2 images to the preview outputs.
2	DSK1PVW	Output the DSK1 image to the preview output.
3	DSK2PVW	Output the DSK2 image to the preview output.
4	Edit-EN	Turns the control of the editor to ON or OFF.
5	COM-EN	Turns the external control using the COM connector to ON or OFF.
6	GPIM-In-EN	Enables or disables GPI-In (at the mainframe side)
7	GPIM-Out-EN	Enables or disables GPI-Out (at the mainframe side)
8	GPIP-In-EN	Enables or disables GPI-In (at the control panel side)
9	GPIP-Out-EN	Enables or disables GPI-Out (at the control panel side)
10	OSD	Turns the on-screen displays on (displayed) or off (not displayed).
11	StrFM1	Imports the images of the AUX1 to AUX4 buses, which have been set using the FMEM menu, into the frame memory (FMEM1).
12	StrFM2	Imports the images of the AUX1 to AUX4 buses, which have been set using the FMEM menu, into the frame memory (FMEM2).
13	StrFM3	Imports the images of the AUX1 to AUX4 buses, which have been set using the FMEM menu, into the frame memory (FMEM3).
14	StrFM4	Imports the images of the AUX1 to AUX4 buses, which have been set using the FMEM menu, into the frame memory (FMEM4).
15	SHIFT	Switches all the A/B bus and AUX bus crosspoints between front and rear.
16	AUX TRAN	Enables or disables the AUX transitions.
17	NoAssign	No assignment

5. System settings

<Setting method>

- ① Press the [CONFIG] button to light its indicator and display the CONFIG menu.
 ☞ Refer to “2-1-5. LCD menu area”.
- ② Turn [F1] to display the Button1 sub menu and Button2 sub menu.

<Menu display>

CONFIG 8	USER1	USER2	USER3	
Button1	PinPPVW	DSK1PVW	OSD	

CONFIG 9	USER4	USER5	USER6	
Button2	Edit-EN	StrFM1	SHIFT	

DSK1PVW	PinPPVW	PinPPVW
DSK2PVW	DSK2PVW	DSK1PVW
Edit-EN	Edit-EN	DSK2PVW
COM-EN	COM-EN	Edit-EN
GPIMIEN	GPIMIEN	COM-EN
GPIMOEN	GPIMOEN	GPIMIEN
GPIPIEN	GPIPIEN	GPIMOEN
GPIPOEN	GPIPOEN	GPIPIEN
OSD	OSD	GPIPOEN
StrFM1	StrFM1	StrFM1
StrFM2	StrFM2	StrFM2
StrFM3	StrFM3	StrFM3
StrFM4	StrFM4	StrFM4
SHIFT	SHIFT	SHIFT
AUXTRAN	AUXTRAN	AUXTRAN
NoAssign	NoAssign	NoAssign

PinPPVW	PinPPVW	PinPPVW
DSK1PVW	DSK1PVW	DSK1PVW
DSK2PVW	DSK2PVW	DSK2PVW
COM-EN	Edit-EN	Edit-EN
GPIMIEN	COM-EN	COM-EN
GPIMOEN	GPIMIEN	GPIMIEN
GPIPIEN	GPIMOEN	GPIMOEN
GPIPOEN	GPIPIEN	GPIPIEN
OSD	GPIPOEN	GPIPOEN
StrFM1	OSD	OSD
StrFM2	StrFM2	StrFM1
StrFM3	StrFM3	StrFM2
StrFM4	StrFM4	StrFM3
SHIFT	SHIFT	StrFM4
AUXTRAN	AUXTRAN	AUXTRAN
NoAssign	NoAssign	NoAssign

● Button1 sub menu

- ③ Turn [F2] to select the function to be assigned to the USER 1 button using the USER1 item.
- ④ Turn [F3] to select the function to be assigned to the USER 2 button using the USER2 item.
- ⑤ Turn [F4] to select the function to be assigned to the USER 3 button using the USER3 item.

● Button2 sub menu

- ⑥ Turn [F2] to select the function to be assigned to the USER 4 button using the USER4 item.
- ⑦ Turn [F3] to select the function to be assigned to the USER 5 button using the USER5 item.
- ⑧ Turn [F4] to select the function to be assigned to the USER 6 button using the USER6 item.

5. System settings

5-4. Setting the date and time

The user can set the date and time to be used as the SD memory card's time stamp. Be absolutely sure to set them when an SD memory card is to be used.

Setting the date

- ① Press the [SYSTEM] button to light its indicator and display the SYSTEM menu.
☞ Refer to “2-1-5. LCD menu area”.
- ② Turn [F1] to display the Date sub menu.
- ③ Turn [F2] to set the year using the Year item.
- ④ Turn [F3] to set the month using the Month item.
- ⑤ Turn [F4] to set the day using the Date item.
- ⑥ Press the [F5] switch to enter the year/month/day.

<Menu display>

SYS 10	Year	Month	Date	Set↓
Date	-	-	-	-
2000	1~12	1~31		
2099				

Setting the time

- ① Press the [SYSTEM] button to light its indicator and display the SYSTEM menu.
☞ Refer to “2-1-5. LCD menu area”.
- ② Turn [F1] to display the Time sub menu.
- ③ Turn [F2] to set the hour using the Hour item.
- ④ Turn [F3] to set the minutes using the Minute item.
- ⑤ Turn [F4] to set the seconds using the Second item.
- ⑥ Press the [F5] switch to enter the hour/minutes/seconds.

<Menu display>

SYS 11	Hour	Minute	Second	Set↓
Time	-	-	-	-
0~23	0~59	0~59		

5. System settings

5-5. Network settings

Proceed with the network settings to perform such tasks as updating the software version via LAN.

The network initial setup is: IP address: 192.168.0.10, subnet mask: 255.255.255.0.

When using the host computer with settings matching the network setup, it is not necessary to setup via the menu.

For the setting to take effect, the system must be rebooted. Turn the system's power off and then back on.

Setting the IP address

- ① Press the [SYSTEM] button to light its indicator and display the SYSTEM menu.
☞ Refer to "2-1-5. LCD menu area".
- ② Turn [F1] to display the Network1 sub menu.
- ③ Turn [F2] to [F5] to set the IP address, and press the [F5] switch (Save) to enter the address.

<Menu display>

SYS	7	IP Address			Save↓
NetWork1		192	168	0	1
		0~255	0~255	0~255	0~255

Setting the subnet mask

- ① On the SYSTEM menu, turn [F1] to display the Network2 sub menu.
- ② Turn [F2] to [F5] to set the subnet mask, and press the [F5] switch (Save) to enter the mask.

<Menu display>

SYS	8	Subnet Mask			Save↓
NetWork2		255	255	255	0
		0~255	0~255	0~255	0~255

Display the MAC address

- ① On the SYSTEM menu, turn [F1] to display the Network3 sub menu.
The MAC address now appears.

<Menu display> (When the MAC address is "008045448000".)

SYS	9	MAC Address		
NetWork3		008045448000		

5. System settings

5-6. Other settings

Setting the LCD backlight

The LCD backlight can be set to ON or OFF.
It is also possible to automatically turn off the LCD backlight when no control panel operation is performed within a set time interval.

- ① Press the [CONFIG] button to light its indicator and display the CONFIG menu.
☞ Refer to “2-1-5. LCD menu area”.
- ② Turn [F1] to display the Operate sub menu.

<Menu display>

CONFIG 1	BusMode	LCD-BL	MENU DLG
Operate	PGM/PST	On	On
	A/B	Off	Off
		60	
		120	
		180	

- ③ Turn [F3] to select the setting for the backlight in the LCD-BL item.
 - On:** Backlight is turned on all the time.
 - Off:** Backlight is turned off all the time.
 - 60, 120, 180:**
When no control panel operation is performed within a set time interval (60 minutes, 120 minutes, 180 minutes), the LCD backlight is turned off automatically.
Even when the set time interval elapses and the LCD backlight is turned off, the backlight comes back on when a control operation is performed.

Menu delegation settings

The enable/disable setting for the menu delegation function is selected.

- ④ Turn [F4] to select the enable/disable setting for the menu delegation function in the MENU DLG item.
 - On:** Enabled, **Off:** Disabled

5. System settings

5-7. External device control

5-7-1. Enable/Disable Setting for Control of External Devices

Set up the control of the external devices (editor, pan-tilt head and/or controller) that have been connected to the RS-422 connector.

- ① Press the [CTL] button to light its indicator and display the CTL menu.

☞ Refer to “2-1-5. LCD menu area”.

- ② Turn [F1] to display the RS422 sub menu.

<Menu display>

CTL	1	Edit-EN	COM-EN		
RS422		Enable	Enable		
		Disable	Disable		

- ③ Turn [F2] and use the Edit-EN item to set up the control of the unit from the external device (editor) that has been connected to the EDITOR connector.

Enable: Control is enabled.

Disable: Control is disabled.

- ④ Turn [F3] and use the COM-EN item to set up the control of the external device (pan-tilt head, controller) that has been connected to the COM connector.

Enable: Control is enabled.

Disable: Control is disabled.

- The Edit-EN item and COM-EN item settings can be assigned to user buttons.

☞ Refer to “5-3-1. Setting the user buttons”.

5. System settings

5-7-2. Editor control

The following lists the functions which can be controlled by editing controller AG-A850.
(Compliant with the GVG protocol)

- Read command
- Crosspoint switch
- Wipe pattern selection (BKGD)
- Transition mode (MIX/WIPE) selection
- Auto transition time setting
- Auto transition execution

<Table of wipe patterns supported>

GVG protocol	AV-HS450N	GVG protocol	AV-HS450N	GVG protocol	AV-HS450N	GVG protocol	AV-HS450N
1	WIPE #1	22	SQ1 #10	43	3D1 #7	64	SL2 #4
2	WIPE #2	23	—	44	3D1 #8	65	—
3	WIPE #3	24	SQ1 #12	45	3D1 #9	66	SL2 #6
4	WIPE #4	25	SL1 #1	46	3D1 #10	67	—
5	WIPE #5	26	SL1 #2	47	3D1 #11	68	SL2 #8
6	WIPE #6	27	SL1 #3	48	3D1 #12	69	—
7	WIPE #7	28	SL1 #4	49	—	70	—
8	WIPE #8	29	SL1 #5	50	SQ2 #2	71	—
9	WIPE #9	30	SL1 #6	51	—	72	—
10	WIPE #10	31	SL1 #7	52	SQ2 #4	73	—
11	WIPE #11	32	SL1 #8	53	—	74	SD2 #2
12	WIPE #12	33	SL1 #9	54	SQ2 #6	75	—
13	SQ1 #1	34	—	55	—	76	SD2 #4
14	SQ1 #2	35	—	56	SQ2 #8	77	—
15	SQ1 #3	36	—	57	—	78	SD2 #6
16	SQ1 #4	37	3D1 #1	58	—	79	—
17	SQ1 #5	38	3D1 #2	59	—	80	SD2 #8
18	SQ1 #6	39	3D1 #3	60	—	81	—
19	SQ1 #7	40	3D1 #4	61	—	82	—
20	SQ1 #8	41	3D1 #5	62	SL2 #2	83	—
21	SQ1 #9	42	3D1 #6	63	—	84	—

On the RS422 sub menu of the CTL menu, set On or Off for control from the external device (editor) connected to the RS-422 connector.

For details on the settings, see “5-7-1. Enable/Disable Setting for Control of External Devices”.

5. System settings

5-7-3. Setting the GPI

The user can set the functions that are to be controlled from the GPI ports and set whether to enable the control.
 ☞ Refer to “6-2-4. TALLY/GPI” and “6-3-1. TALLY/GPI”.

- ① Press the [CONFIG] button to light its indicator and display the CONFIG menu.
 ☞ Refer to “2-1-5. LCD menu area”.
- ② Turn [F1] to display the sub menu corresponding to the TALLY/GPI connector concerned and set the function to be controlled by the GPI port.

TALLY/GPI connector of mainframe:

GPIM-In sub menu and GPIM-Out sub menu

<Menu display>

CONFIG 4	Port	Assign		GPIEN
GPIM-In		- NoAssign		Disable

Port1~8

Enable

CONFIG 5	Port	Assign		GPIEN
GPIM-Out		- NoAssign		Disable

Port1
|
Port31

Enable

TALLY/GPI connector of control panel:

GPIP-In sub menu and GPIP-Out sub menu

<Menu display>

CONFIG 6	Port	Assign		GPIEN
GPIP-In		- NoAssign		Disable

Port1~8

Enable

CONFIG 7	Port	Assign		GPIEN
GPIP-Out		- NoAssign		Disable

Port1~8

Enable

- ③ Turn [F2] to select the port to be controlled using the Port item.
- ④ Turn [F3] to select the function to be assigned using the Assign item.
 ☞ Refer to “Control using the GPI input port” and “Output from the GPI output port”.
- ⑤ Turn [F5] to set enable or disable for the control to be exercised from each port using the GPIEN item.
 - Enable:** Control is enabled.
 - Disable:** Control is disabled.

- Settings for the GPIEN item can be assigned to one of the user buttons.
 ☞ See “5-3-1. Setting the user buttons”.

5. System settings

■ Control using the GPI input port

Assign Item	Description of function assigned	Control method
AUTO	AUTO button in transition area	Operations are performed using contact inputs (30ms or more).
CUT	CUT button in transition area	
DSK1	DSK1 button in transition area	
DSK2	DSK2 button in transition area	
PinP1	PinP1 button in transition area	
PinP2	PinP2 button in transition area	
FTB	FTB button in transition area	
BGDAUTO	AUTO button when the background is selected	
BGDCUT	CUT button when the background is selected	
KEYAUTO	AUTO button when the key is selected	
KEYCUT	CUT button when the key is selected	
RTlyDBL	Red tally signal is not output	Functions are enabled using contact inputs (or disabled in open status).
GTlyDBL	Green tally signal is not output	
NoAssign	No function assigned	

■ Output from the GPI output port

Assign Item	Description of function assigned	Output
CUT	Cut transition executed	Low pulses are output (approx. 50 to 60 ms).
KEYON	Key transition start	
DSK1ON	DSK1 transition start	
DSK2ON	DSK2 transition start	
PinP1ON	PinP1 transition start	
PinP2ON	PinP2 transition start	
FTBON	FTB transition start	
BGDCUT	Cut transition for the background executed	
KEYCUT	Cut transition for a key executed	
AUTO	Auto transition execution in progress	A low level is output.
BGDAUTO	Auto transition execution in progress for background	
KEYAUTO	Auto transition execution in progress for key	
KEYTRN	Transition execution in progress for key	
DSK1TRN	Transition execution in progress for DSK1	
DSK2TRN	Transition execution in progress for DSK2	
PinP1TRN	Transition execution in progress for PinP1	
PinP2TRN	Transition execution in progress for PinP2	
FTBTRN	Transition execution in progress for FTB	A low level is output during tally output.
R-Tly1 to 20	Red tally for INPUT1 to 20	
G-Tly1 to 20	Green tally for INPUT1 to 20	
NoAssign	No function assigned	

5. System settings

5-7-4. Camera control

A camera and pan-tilt head can be controlled from this unit.

Up to five cameras can be controlled via a controller (AW-RP655N or AW-RP555N) connected to the unit's COM connector.

The unit can also be connected directly to a pan-tilt head, and the camera and pan-tilt head can be controlled.

To control a camera in this way, select "P/TCont" or "P/TDir" as the Protocol item setting.

Be absolutely sure that the power of the equipment is turned off before proceeding to connect the cables.

Functions that can be controlled from the unit

- Switching of the cameras to be controlled in line with the selection of the crosspoint buttons (PGM/A 1 to 32 and PST/B 1 to 32).
- The camera and pan-tilt head's pan-tilt operations and zooming and focusing operations are controlled.
- The operations for the setting menus of the camera are performed.
- When the unit is connected directly to a pan-tilt head, the red tally signal and power on/off are controlled from the COM connector.

5. System settings

Example of connections (when the unit and a controller are connected)

Controllers that can be connected: AW-RP655N, AW-RP555N

For details on connecting the pan-tilt heads and controller or connecting the pan-tilt heads and cameras, refer to the operating instructions of each device.

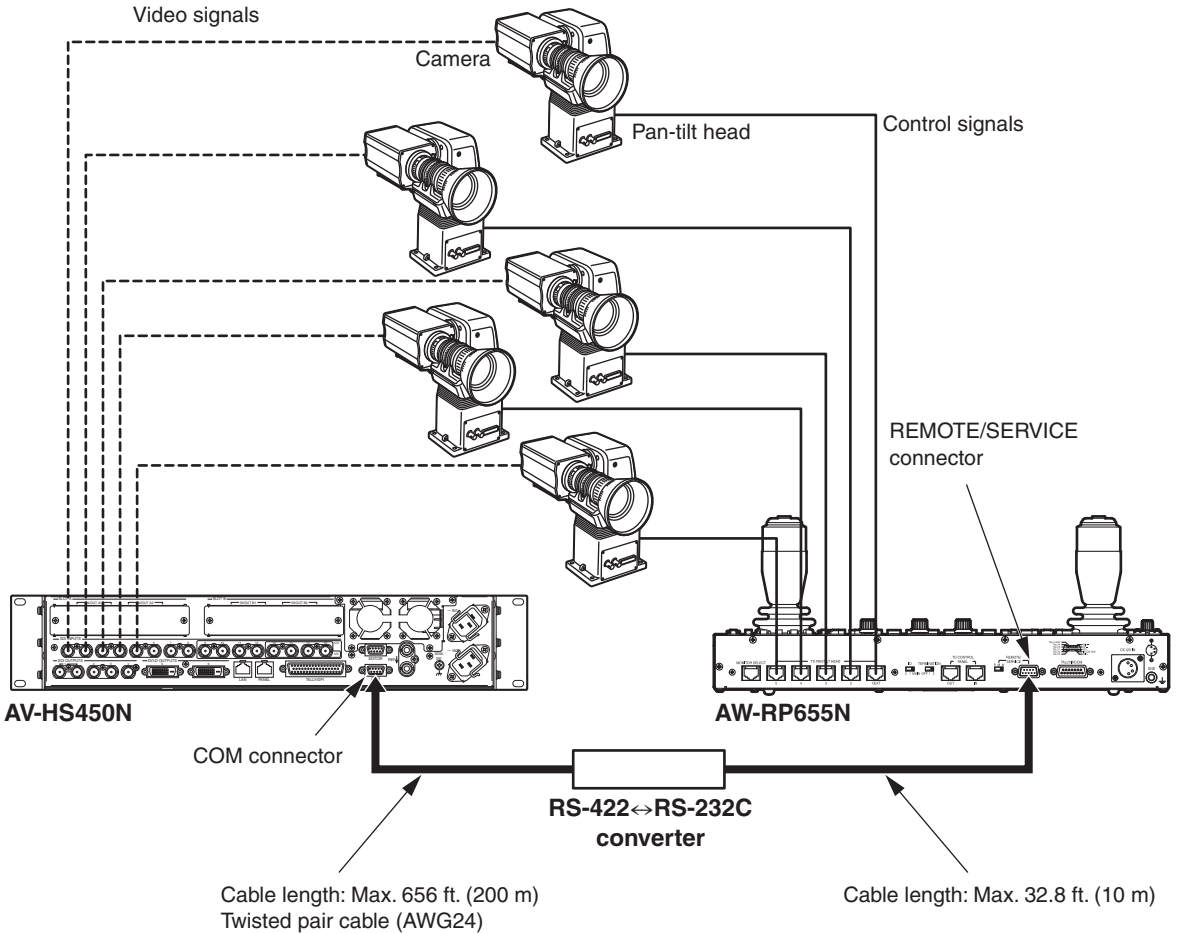

<Connection specifications>

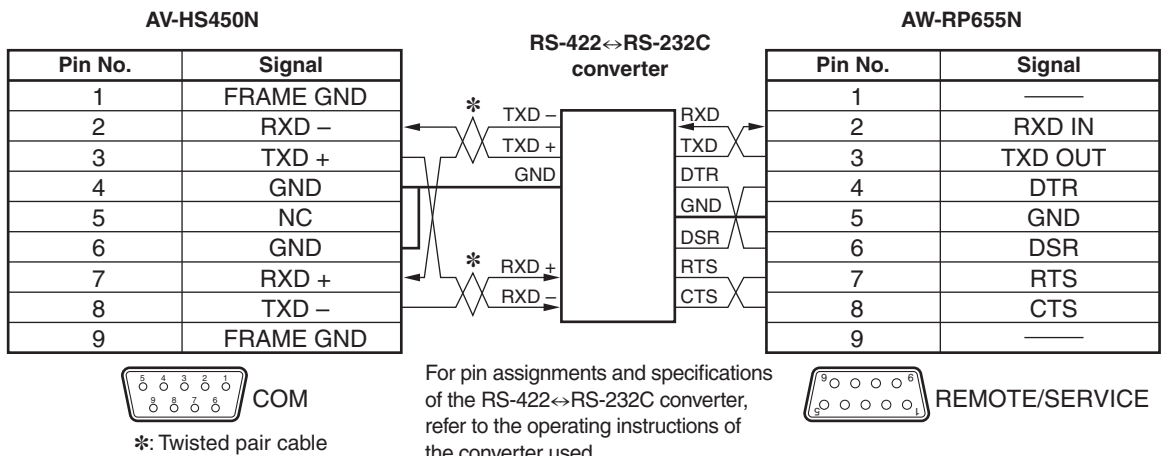

5. System settings

Example of connections (when the unit and a pan-tilt head are connected)

Pan-tilt heads that can be connected: AW-HE100N, AW-PH400P, AW-PH405N, AW-PH360N

■ Connections for AW-HE100N, AW-PH405N or AW-PH360N

Analog component signals
(For the connection specifications, refer to the Operating Instructions of the AW-HE100N.)

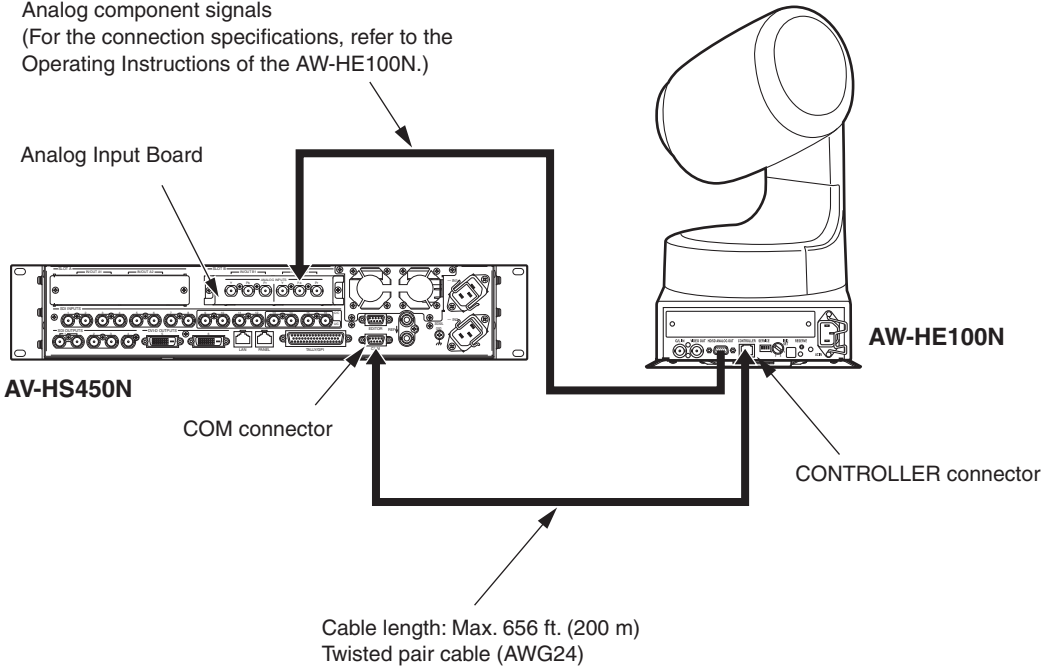

<Connection specifications>

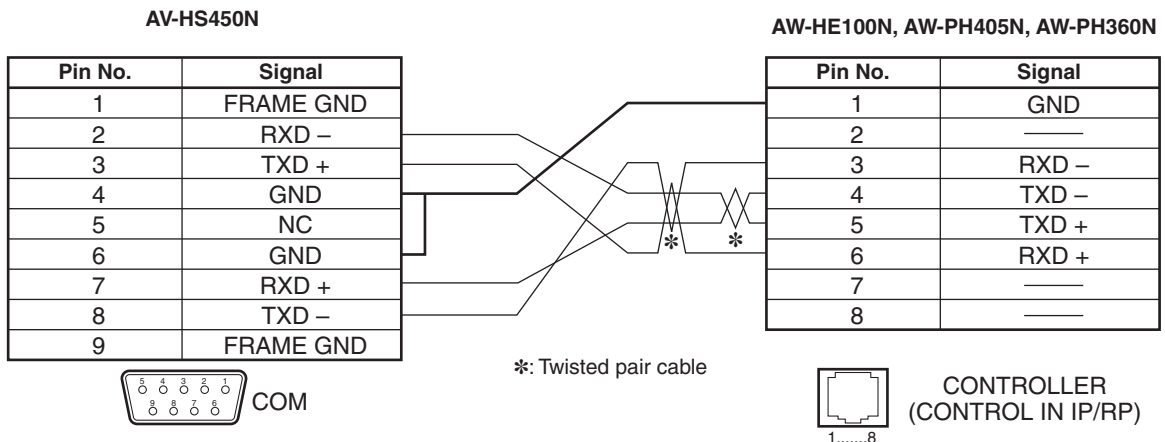

When the AW-HE100N is to be connected to the unit, select a setting which will enable operations to be controlled by the controller in the “Controller” item of the AW-HE100N’s pan-tilt head unit setting menu (** Pan Tilt Head Setting **).

For further details, refer to the Operating Instructions of the AW-HE100N.

5. System settings

■ Connections for AW-PH400P

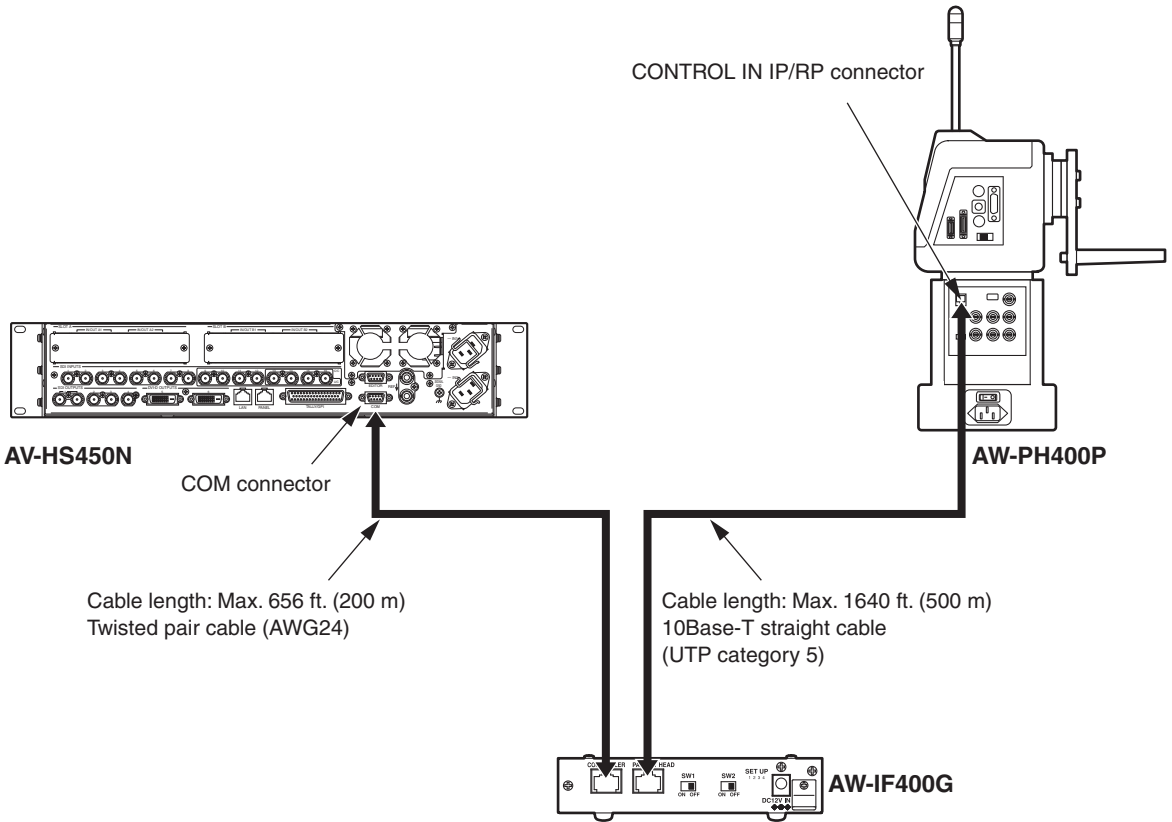

Switch settings

SW1	SW2	SET UP			
		1	2	3	4
OFF	OFF	ON	OFF	ON (300 deg)	OFF (190 deg)

<Connection specifications>

AV-HS450N

Pin No.	Signal
1	FRAME GND
2	RXD -
3	TXD +
4	GND
5	NC
6	GND
7	RXD +
8	TXD -
9	FRAME GND

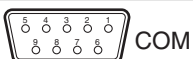

AW-IF400G

Pin No.	Signal
1	GND
2	—
3	RXD -
4	TXD -
5	TXD +
6	RXD +
7	—
8	—

*: Twisted pair cable



5. System settings

Camera control settings

Five cameras can be controlled either through the controller that is used for the camera (AW-RP555N or AW-RP655N) connected to the COM connector, or through the controller that is used for the pan-tilt head.

- Press the [CAM] button to light its indicator and display the CAM menu.
☞ Refer to “2-1-5. LCD menu area”.

- Turn [F1] to display the CamCTL1 sub menu.

<Menu display>

CAM	1	CTL	Signal	Tally	Protcol
CamCTL1		1	None	Disable	P/TCont
		1~5	IN1~16	Enable	P/TDirt
			IN-A1		
			IN-A2		
			IN-B1		
			IN-B2		

- Turn [F2] to set the control signal (for the camera) that supports the input signal using the CTL item. Establish the associations between the switching of the cameras linked to the selection of the crosspoint buttons (PGM/A 1 to 32 and PST/B 1 to 32) and the tally control.
 - When camera control is enabled, the “c” mark appears on the multi view display in front of the names of the materials in the cameras targeted for control.
 - When “P/TDirt” has been selected as the Protcol item, only “1” appears.

- Turn [F3] to select the input signal using the Signal item.

- Turn [F4] to enable or disable tally control using the Tally item.
This setting can be selected when “P/TDirt” has been selected as the Protcol item.

Enable: Tally control is enabled.
Red tally signal On/Off control is exercised from the RS-422 interface connector.

Disable: Tally control is disabled.

- Turn [F5] to set the device to be controlled using the Protcol item.

P/TCont: The controller for the camera or controller for the pan-tilt head is controlled.

Select this when the controller is to be connected to the unit and a multiple number of cameras and/or pan-tilt heads are to be controlled.

P/TDirt: Select this when a pan-tilt head is to be connected directly to the unit and the camera and the pan-tilt head are to be controlled.

5. System settings

⑦ Turn [F1] to display the CamCTL2 sub menu.

<Menu display>

CAM	2	CTL	PosCont	PTSpeed	Power↓
CamCTL2		1	PanTilt	Fast	On
	1~5	Zm/Focs	Middle		Off
			Slow		

⑧ Turn [F2] to set the camera to be controlled using the CTL item.

⑨ Turn [F3] to select the control to be exercised by operating the positioner using the PosCont item.

PanTilt: Panning is controlled by left/right (X) operation; tilting is controlled by up/down (Y) operation.

Zm/Focs: Lens focusing is controlled by left/right (X) operation; lens zooming is controlled by up/down (Y) operation.

Each time the rotary encoder [Z] is pressed, the PanTilt or Zm/Focs setting is selected alternately.

- Control of lens focusing is possible when the lens focus of the camera is set to manual operation.
- If the crosspoint buttons (PGM/A 1 to 32 and PST/B 1 to 32) are held down when "P/TCont" or "P/TDirt" is selected as the Protocol item setting, delegation to the CamCTL2 menu is initiated.

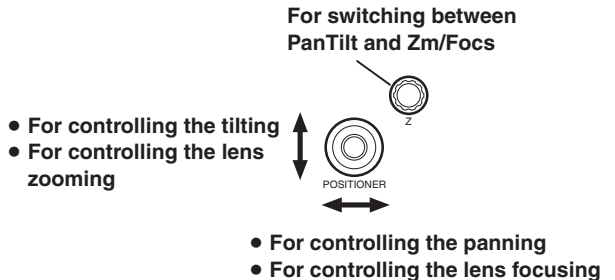

⑩ Turn [F4] to set the control (panning, tilting, lens focusing and lens zooming) speed using the PTSPEED Item.

Fast: Control is exercised at the fastest speed.

Middle: Control is exercised at the medium speed.
(This cannot be selected for the control of lens focusing or lens zooming.)

Slow: Control is exercised at the slowest speed.

⑪ When controlling the pan-tilt head's power to On, turn [F5] to select On, and press the [F5] switch.

When controlling it to Off, turn [F5] to select Off, and press the [F5] switch.

After turning the pan-tilt head's power to On, make sure to use this operation to turn the selection On. This setting can be performed when "P/TDirt" has been selected as the Protocol item setting on the CamCTL1 sub menu.

- The menu display (On or Off) does not indicate the status of the camera.

5. System settings

Camera's menu operations

The camera's menu displays, the movements of the cursor displayed on the menus and the entry of the changes made can be performed from the unit.

- ① Press the [CAM] button to light its indicator and display the CAM menu.
☞ Refer to "2-1-5. LCD menu area".

- ② Turn [F1] to display the CamCTL3 sub menu.

<Menu display>

CAM	3	CTL	C-Menu↓	Item	Val/Y/N
CamCTL3		1	-	-	-
		1~5	On Off	Cursor	Cursor

- ③ Turn [F2] to set the camera to be controlled using the CTL item.
- ④ If the camera's menus are to be displayed, turn [F3] to select On, and then press the [F3] switch. If they are not to be displayed, turn [F3] to select Off and then press the [F3] switch.
When On has been selected, "Cursor" is displayed in the Item and Val/Y/N items.
- ⑤ The cursor displayed on the camera's menus can now be moved by turning [F4]. Turn [F4] clockwise to move the cursor down or counterclockwise to move it up.
- ⑥ Turn [F5] clockwise to move to the camera's setup screen.

Operation of [F5] in the setup screen

Selecting Yes/No:

Turn clockwise to select "Yes (confirmed)" and turn counterclockwise to select "No (unconfirmed)".

Changing values:

Turn clockwise to increase and turn counterclockwise to decrease.

5. System settings

5-8. Status displays

5-8-1. Alarm status displays

The alert status (alarms) for this unit's power supply and cooling fan are displayed on the LCD.

- ① Press the [SYSTEM] button to light it, and display the SYSTEM menu.
 Refer to "2-1-5. LCD menu area".
- ② Turn [F1] to display the Alarm sub menu.

<Menu display>

SYS	5	Power	Fan		
Alarm		NoAlarm	NoAlarm		
		Alarm	Alarm		

The alert status of the power supplies (mainframe and control panel) is displayed in the Power item.
 The alert status of the cooling fan (mainframe) is displayed in the Fan item.

NoAlarm: No irregularity
Alarm: Irregularity

5-8-2. Alarm message

A message is displayed on the LCD when an alarm has occurred.

Alarm message displayed	Type of trouble	Operation
ALARM ! FAN STOP	Cooling fan stopped (mainframe)	The alarm message disappears when a menu operation is performed.
ALARM ! MF POWER FAILURE	Power supply voltage drop (mainframe)	
ALARM ! MF POWER FAILURE & FAN STOP	Power supply voltage drop and cooling fan stopped (mainframe)	
ALARM ! PANEL POWER FAILURE	Power supply voltage drop (control panel)	
ALARM ! PANEL POWER FAILURE & FAN STOP	Power supply voltage drop (control panel) and cooling fan stopped (mainframe)	
ALARM ! PANEL & MF POWER FAILURE	Power supply voltage drop (control panel and mainframe)	
ALARM ! PANEL & MF POWER FAILURE & FAN STOP	Power supply voltage drop (control panel and mainframe) and cooling fan stopped (mainframe)	
ALARM ! VER IS DISAGREEMENT PANEL-Ver[■■■■] MF-Ver[xxxxxx]	Mainframe and control panel versions do not match	Recovery is not possible without matching the versions of the mainframe and control panel. No operations can be performed from the control panel until versions are matched up.
ALARM ! LAN CONNECTION ERROR	LAN communication malfunction between mainframe and control panel	The message remains displayed and no operations can be performed from the control panel until the trouble is remedied and normal operation is restored.

5. System settings

5-8-3. Displaying the version information and option information

Information on the unit's software and hardware versions and the statuses of the options are displayed.

<Menu display>

SYS 12	Select	Version	SysVer
MainVer	MFSOFT	1.00	1.00.00

- Pn1Soft
- Pn1FPGA
- CntFPGA
- In1FPGA
- In2FPGA
- M/EFPGA
- OutFPGA

- ① Press the [SYSTEM] button to light its indicator and display the SYSTEM menu.
 Refer to "2-1-5. LCD menu area".
- ② Turn [F1] to display the MainVer sub menu.
- ③ Turn [F2] to select the item whose version is to be displayed using the Select item.
- ④ The version information is displayed in the Version item.
 The system version information is displayed in the SysVer item.

MFSOFT	Software version of mainframe	In1FPGA	Hardware version of input circuit board 1 (mainframe)
Pn1Soft	Software version of control panel	In2FPGA	Hardware version of input circuit board 2 (mainframe)
Pn1FPGA	Hardware version of control panel	M/EFPGA	Hardware version of M/E circuit board (mainframe)
CntFPGA	Hardware version of control circuit board (mainframe)	OutFPGA	Hardware version of output circuit board (mainframe)

- ⑤ Turn [F1] to display the OptVer sub menu.

<Menu display>

SYS 13	Select	Board	Version
OptVer	SLOTA	SDI-IN	0001

SLOTB

- ⑥ Turn [F2] to select the option slot using the Select item.

SLOTA: Option slot A

SLOTB: Option slot B

- ⑦ The types of the optional boards connected are displayed in the Board item.

SDI-IN	SDI input board	SDI-OUT	SDI output board
Ana-IN	Analog input board	Ana-OUT	Analog output board
DVI-IN	DVI input board	D/A-OUT	DVI/analog output board
DVID-IN	Full-HD DVI input board	None	No optional board
CsIt-IN	Analog composite input board		

- ⑧ The optional board version information is displayed in the Version item.

5. System settings

5-9. Initialization

5-9-1. Initializing Setting Data

Initialization returns the set data to the factory shipment status.
(The network settings and the date and time settings are not initialized.)

- ① Press the [SYSTEM] button to light its indicator and display the SYSTEM menu.
☞ Refer to “2-1-5. LCD menu area”.
- ② Turn [F1] to display the Initial sub menu.

<Menu display>

SYS	6	Init↓	F Init↓		
Initial					

- ③ Press [F2] to initialize the settings. The “Init?” message appears.
- ④ To initialize the settings, turn [F2] to select YES, and then press the [F2] switch.
To cancel the initialization, turn [F2] to select No, and then press the [F2] switch.

<Menu display>

SYS	6	Init↓	F Init↓		
Initial		No			

YES

5-9-2. Initializing Fader

The range for executing a transition can be initialized by operating the fader lever.
Initialization should be performed when transitions are not completed to the end even when the fader lever has been moved as far as it will go.

- ⑤ Press [F3] in the Initial sub menu to perform initialization.
The "F Init?" message is displayed.

<Menu display>

SYS	6	Init↓	F Init↓		
Initial			No		

YES

- ⑥ When initializing, turn [F3] to select “Yes” and press the [F3] switch.
When not initializing, turn [F3] to select “No” and press the [F3] switch.

6. External interfaces

6-1. Connecting the control panel and mainframe

Connect the MAIN FRAME connector on the control panel and PANEL connector on the mainframe using the CAT5E cable supplied.

CAT5E, straight cable, STP (shielded twisted pair), 10 m

Provide the cable below if the control panel and mainframe are installed in a location where the CAT5E cable provided is not long enough to connect them (where the distance between the control panel and mainframe is more than 10 meters).

CAT5E, straight cable or crossover cable, STP (shielded twisted pair), max. 100 m

6-2. Mainframe

6-2-1. LAN

Connect the host computer to the LAN connector on the mainframe when the image transfer function is to be used. Provide the cable below to connect the host computer.

CAT5E, straight cable or crossover cable, STP (shielded twisted pair), max. 100 m

For details on the image transfer settings, refer to “7. Image transmission functions”.

6. External interfaces

6-2-2. EDITOR

The unit can be controlled by an external device by connecting the device to the EDITOR connector. Use it with the settings below.

Baud rate: 38400 bps

Parity: ODD

Stop bit: 1 bit

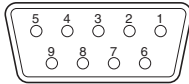

RS-422, D-sub 9-pin, female, inch screw

Pin No.	Signal name	Description of signal
1	FRAME GROUND	Frame ground
2	TXD –	Send data (–)
3	RXD +	Receive data (+)
4	GROUND	Ground
5	NC	Not used
6	GROUND	Ground
7	TXD +	Send data (+)
8	RXD –	Receive data (–)
9	FRAME GROUND	Frame ground

6-2-3. COM

One or more Panasonic pan-tilt head systems can be controlled by the unit by connecting the system to the COM connector.

For details on the connections, refer to “5-7-4. Camera control”.

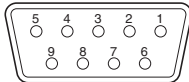

RS-422, D-sub 9-pin, female, inch screw

Pin No.	Signal name	Description of signal
1	FRAME GROUND	Frame ground
2	RXD –	Receive data (–)
3	TXD +	Send data (+)
4	GROUND	Ground
5	NC	Not used
6	GROUND	Ground
7	RXD +	Receive data (+)
8	TXD –	Send data (–)
9	FRAME GROUND	Frame ground

- The pin assignment is different from that of the EDITOR connector.

6. External interfaces

6-2-4. TALLY/GPI

This connector is provided with eight contact input ports (GPI In) for controlling the unit from an external device, 31 ports (GPI Out) for outputting the tally and status information from the unit to the external device, and one port (ALARM Out) that is used exclusively as the alarm output. For details of the settings, refer to “5-7-3. Setting the GPI”.

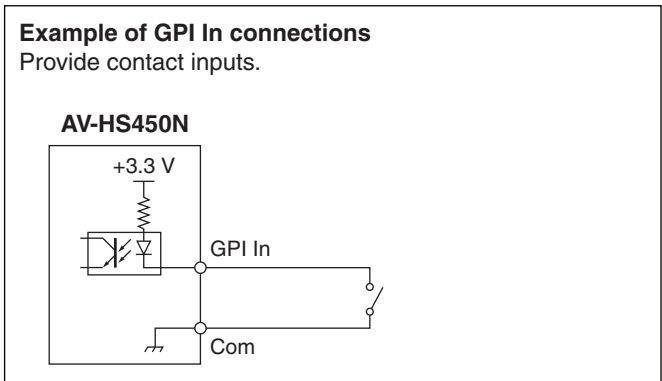
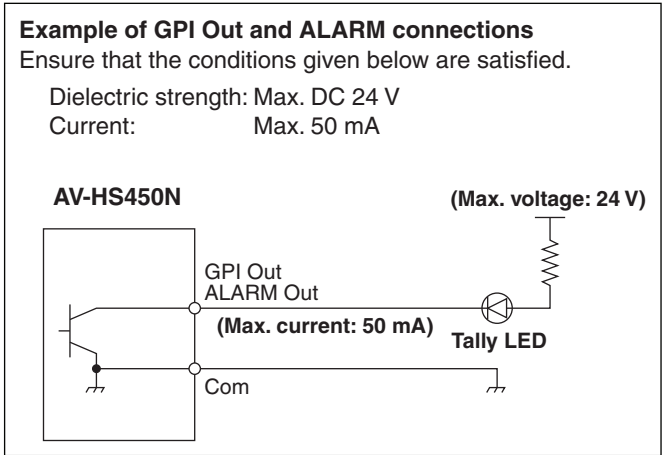
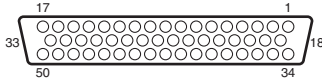

D-sub 50-pin, female, inch screw

Pin No.	Signal name	
1	GPI In Com	IN
34	GPI In Com	
18	GPI In 1	
2	GPI In 2	
35	GPI In 3	
19	GPI In 4	
3	GPI In 5	
36	GPI In 6	
20	GPI In 7	A
4	GPI In 8	
37	GPI Out Com	
21	GPI Out 1	
5	GPI Out 2	B
38	GPI Out 3	
22	GPI Out 4	
6	GPI Out Com	C
39	GPI Out 5	
23	GPI Out 6	
7	GPI Out 7	
40	GPI Out 8	D
24	GPI Out Com	
8	GPI Out 9	
41	GPI Out 10	E
25	GPI Out 11	
9	GPI Out 12	
42	GPI Out Com	F
26	GPI Out 13	
10	GPI Out 14	
43	GPI Out 15	G
27	GPI Out 16	
11	GPI Out Com	
44	GPI Out 17	H
28	GPI Out 18	
12	GPI Out 19	
45	GPI Out 20	
29	GPI Out Com	
13	GPI Out 21	
46	GPI Out 22	
30	GPI Out 23	
14	GPI Out 24	
47	GPI Out Com	
31	GPI Out 25	
15	GPI Out 26	
48	GPI Out 27	
32	GPI Out 28	
16	GPI Out Com	
49	GPI Out 29	
33	GPI Out 30	
17	GPI Out 31	
50	ALARM Out	

6. External interfaces

6-3. Control panel

6-3-1. TALLY/GPI

This connector is provided with eight contact input ports (GPI In) for controlling the unit from an external device, 8 ports (GPI Out) for outputting the tally and status information from the unit to the external device, and one port (ALARM Out) that is used exclusively as the alarm output. For details of the settings, refer to “5-7-3. Setting the GPI”.

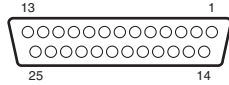

Example of GPI Out and ALARM connections

Ensure that the conditions given below are satisfied.

Dielectric strength: Max. DC 24 V

Current: Max. 50 mA

AV-HS450N

(Max. voltage: 24 V)

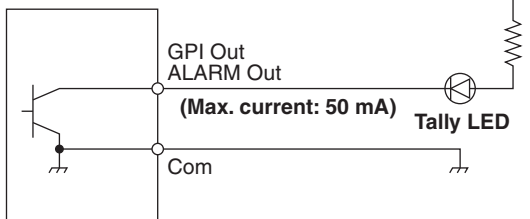

Example of GPI In connections

Provide contact inputs.

AV-HS450N

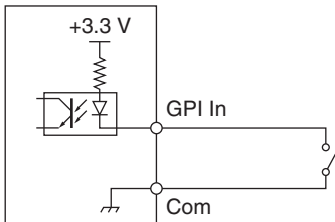

D-sub 25-pin, female, inch screw

Pin No.	Signal name	
1	GPI In Com	IN
14	GPI In Com	
2	GPI In 1	
3	GPI In 2	
15	GPI In 3	
16	GPI In 4	
4	GPI In 5	
17	GPI In 6	
5	GPI In 7	A
18	GPI In 8	
6	GPI Out Com	
19	GPI Out 1	
7	GPI Out 2	B
20	GPI Out 3	
8	GPI Out 4	
21	GPI Out Com	
9	GPI Out 5	
22	GPI Out 6	
10	GPI Out 7	
23	GPI Out 8	
11	DC 5 V	
24	DC 5 V	
12	NC	
25	ALARM Com	
13	ALARM Out	

7. Image transmission functions

This unit comes with a function for transmitting still images from the host computer to the unit via LAN and a function for importing still images from the unit into the host computer. The image transmission software must be installed in the host computer from the CD-ROM supplied in order to use these functions. For details on installation, refer to “How to install the software”.

Specifications

Run the image transmission software (HS450 Tool) in a host computer which satisfies the following conditions.

- Operating system: Windows 2000 or Windows XP
- Processor: Pentium III, 1 GHz or better recommended
- RAM: 256 MB or more recommended
- Hard disk drive: At least 50 MB of free memory
- LAN: 100BASE-TX/10BASE-T
- Display: TrueColor (24 bit, 32 bit color), 800 × 600 dots or more

The image formats supported include bitmap (bmp), JPEG (jpg), TIFF (tif), GIF (gif) and PNG (png). The image transmission software is equipped with a function for automatically converting images into the specified video format size.

Connections

Connect the LAN connector on the mainframe to the host computer using the LAN cable. The LAN connector comes with an Auto-MDI/MDI-X function. Use a LAN straight cable or LAN crossover cable for the connection. For details on network setup such as IP addresses, refer to “5-5. Network settings”.

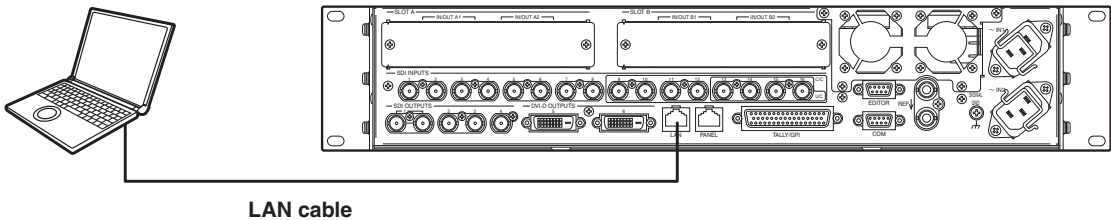

7. Image transmission functions

How to install the software

This section describes how to install the image transmission software (HS450 Tool). Windows XP is used as the host computer's operating system in the example given here.

1. Insert the CD-ROM supplied with the unit into the CD-ROM drive of the host computer in which the program will be installed. (Here, E: will serve as the name of this drive for example.)
2. Execute the setup program (E:\HS450TOOL\ENG\SETUP.EXE).
3. The installer now starts up so follow its instructions to proceed.

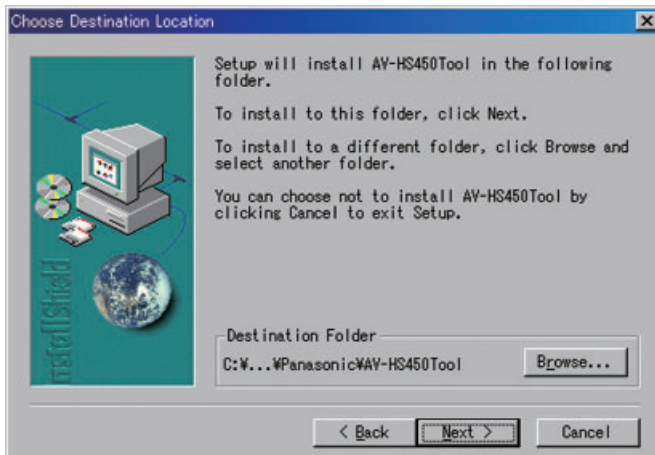

4. The Setup Complete screen appears to indicate that installation is complete. Click [Finish] to close the window.

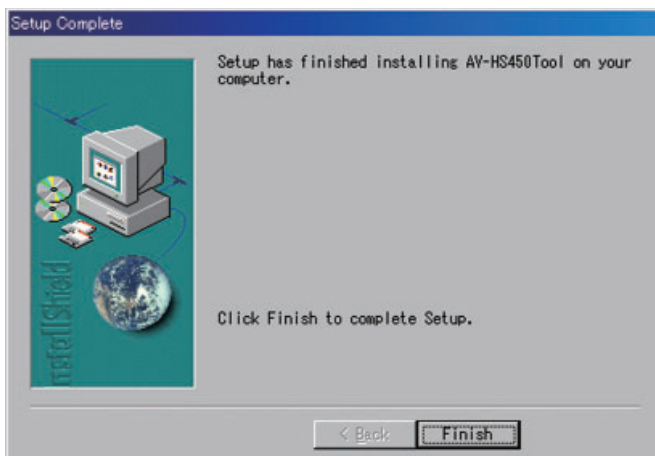

7. Image transmission functions

Operation

This section describes how to operate the image transmission software (HS450 Tool).

<Startup>

On the Start menu of Windows, select [Programs] → [Panasonic] → [AV-HS450Tool] → [HS450Tool].
The main screen now appears.

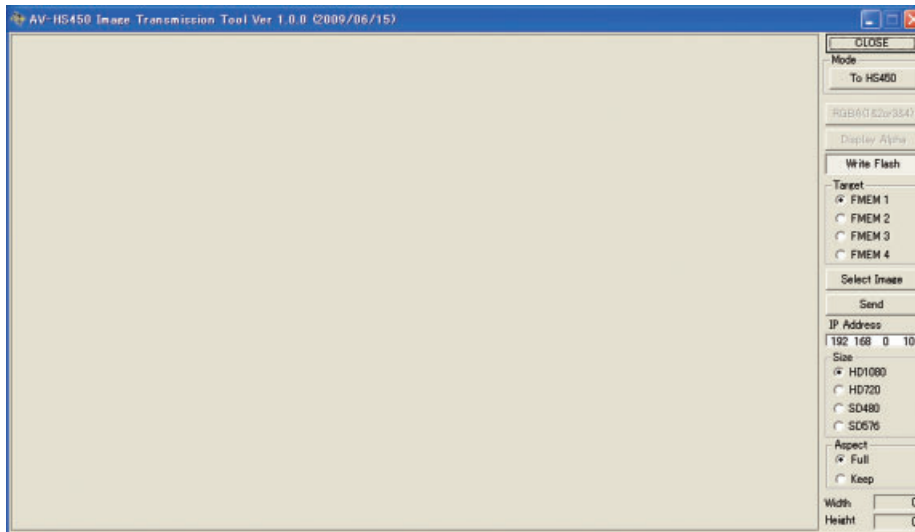

<Exit>

Click the [CLOSE] button.

<Setting the IP address>

Set the unit's IP address in the IP Address setting box.

7. Image transmission functions

<Transmitting images to the unit>

1. Select the mode.
Check that "To HS450" appears in the [Mode] field.
If "From HS450" appears instead, click the [From HS450] button so that "To HS450" appears.
2. Select the transmission destination of the images in the [Target] field.
FMEM1: Unit's frame memory 1
FMEM2: Unit's frame memory 2
FMEM3: Unit's frame memory 3
FMEM4: Unit's frame memory 4
3. When the [Select Image] button is clicked, the file selection dialog box appears on the screen.
Select the image file to be transmitted, and click [OK].
The image is now displayed in the image display area, and its horizontal and vertical dimensions appear in the [Width] and [Height] fields at the bottom right.
4. In the [Size] field, select the size of the image to be transmitted to the unit.
HD1080 (1920×1080), HD720 (1280×720), SD480 (720×487) or SD576 (720×576) can be selected as the size. If the image is in a different video format from the ones supported by the unit, the output will not be displayed properly.
5. In the [Aspect] field, select the scaling method.
If the size of the image to be transmitted and the selected image differ, the image will be automatically scaled according to one of the following methods.
Full: The size of the image is increased or reduced so that it fits the size selected in the [Size] field. If the aspect ratio of the image to be transmitted differs from that of the selected image, the ratio between the horizontal and vertical dimensions will be changed.
Keep: The image is expanded or reduced while its original aspect ratio is kept unchanged. Any empty spaces in the image will appear black.
6. The [RGBA(1&2or3&4)] button can be selected when images containing the alpha channel are to be transmitted.
Click the [RGBA(1&2or3&4)] button and select "FMEM1" in the [Target] field to transmit the RGB images to frame memory 1 (FMEM1) and the alpha channel images to frame memory 2 (FMEM2).
Selecting "FMEM3" in the [Target] field to transmit the RGB images to frame memory 3 (FMEM3) and the alpha channel images to frame memory 4 (FMEM4).
When the [Display Alpha] button is clicked, the alpha channel images appear as a preview display.
7. When the [Send] button is clicked, images are transmitted to the unit and images are saved in frame memory and flash memory.
 - The [Wright Flash] button is always in the selected status.
When not saving images in the flash memory, click the [Wright Flash] button to deselect the [Wright Flash] button.

7. Image transmission functions

<Transmitting images from the unit>

1. Select the mode.
Check that "From HS450" appears in the [Mode] field.
If "To HS450" appears instead, click the [To HS450] button so that "From HS450" appears.

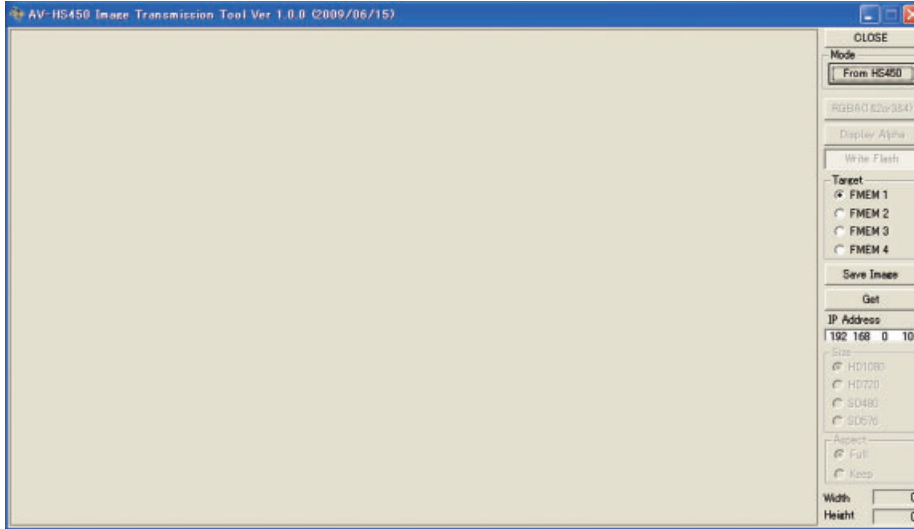

2. Select the images to be imported to the host computer in the [Target] field.
 - FMEM1:** Images in unit's frame memory 1
 - FMEM2:** Images in unit's frame memory 2
 - FMEM3:** Images in unit's frame memory 3
 - FMEM4:** Images in unit's frame memory 4
3. When the [Get] button is clicked, the image is imported from the unit.
The image is now displayed in the image display area, and its horizontal and vertical dimensions appear in the Width and Height fields at the bottom right.
4. When the [Save Image] button is clicked, the file save dialog box appears on the screen. Select the image file to be transmitted, and click [Save].

8. Setting menu table

A setting is entered when an item displayed (↓) is selected and then the [F1], [F2], [F3], [F4] or [F5] switch is pressed.

(It will not be entered unless the switch is pressed.)

Menu	Sub menu		Parameter 1	Parameter 2	Parameter 3	Parameter 4
	Turn F1 to select.		Turn F2 to select.	Turn F3 to select.	Turn F4 to select.	Turn F5 to select.
KEY	KEY 1	Parameter	Type	LumKey	Fill	PVW
	KEY	Setting range	Lum, Linear, Chroma, Full	ChrmOn, ChrmOff	Bus, Matte	Auto, Off, On
		Default value	Linear	ChrmOff	Bus	Auto
	KEY 2	Parameter	Clip	Gain	Density	Invert
	Adjust	Setting range	0.0 to 108.0	0.0 to 200.0	0.0 to 100.0	On, Off
		Default value	0.0	100.0	100.0	Off
	KEY 3	Parameter	Hue	Sat	Lum	Load ↓
	FillMatt	Setting range	0.0 to 359.9	0.0 to 100.0	0.0 to 108.0	White, Yellow, Cyan, Green, Magenta, Red, Blue, Black
		Default value	0.0	0.0	100.0	White
	KEY 4	Parameter	Type	Width	Direc	
	Edge	Setting range	Off, Border, Drop, Shadow, Outline	0 to 4	0, 45, 90, 135, 180, 225, 270, 315	
		Default value	Off	2	0	
	KEY 5	Parameter	Hue	Sat	Lum	Load ↓
	EdgeCol	Setting range	0.0 to 359.9	0.0 to 100.0	0.0 to 108.0	White, Yellow, Cyan, Green, Magenta, Red, Blue, Black
		Default value	0.0	0.0	0.0	Black
	KEY 6	Parameter	X-Pos	Y-Pos		CopyTo ↓
	WIPEPos	Setting range	-100.00 to 100.00	-100.00 to 100.00		Displays the copy destination.
		Default value	0.00	0.00		
	KEY 7	Parameter	X-Pos	Y-Pos		CopyTo ↓
	SQPos	Setting range	-100.00 to 100.00	-100.00 to 100.00		Displays the copy destination.
		Default value	0.00	0.00		
	KEY 8	Parameter	X-Pos	Y-Pos	Size	
	FlyKEY	Setting range	-100.00 to 100.00	-100.00 to 100.00	0.0 to 400.0	
		Default value	0.00	0.00	100.0	
KEY 9	Parameter	Light				
Modify	Setting range	On, Off				
	Default value	Off				
KEY 10	Parameter	Mask	Invert			
Mask	Setting range	Off, Manual, 4:3	On, Off			
	Default value	Off	Off			
KEY	KEY 11	Parameter	Left	Top	Bottom	Right
	MaskAdj	Setting range	-50.00 to 50.00	-50.00 to 50.00	-50.00 to 50.00	-50.00 to 50.00
		Default value	-25.00	25.00	-25.00	25.00
	KEY 12	Parameter	OutPatt			
Trans	Setting range	Nor, Rev				
	Default value	Nor				

8. Setting menu table

Menu	Sub menu		Parameter 1	Parameter 2	Parameter 3	Parameter 4
	Turn F1 to select.		Turn F2 to select.	Turn F3 to select.	Turn F4 to select.	Turn F5 to select.
CHR KEY	CHRKEY 1	Parameter	AutCmp ↓			RESET ↓
	AutoCmp	Setting range				
		Default value				
	CHRKEY 2	Parameter	View	Mode		UNDO ↓
	Sample1	Setting range	Cmpsit, Matte, Proc.FG, FG	SelBG, Cln.BG, Cln.FG, Spl.Spg		
		Default value	Cmpsit	SelBG		
	CHRKEY 3	Parameter	View	Mode		UNDO ↓
	Sample2	Setting range	Cmpsit, Matte, Proc.FG, FG	Spill-, Spill+, Matte-, Matte+, Detail-, Detail+, MatSpng, MkFGTrn, RstrDtl		
		Default value	Cmpsit	Spill-		
	CHRKEY 4	Parameter	View	Spill	Trans	Detail
	FineTun	Setting range	Cmpsit, Matte, Proc.FG, FG	-1000 to 1000	-1000 to 1000	-1000 to 1000
		Default value	Cmpsit	0	0	0
PinP1	PinP1 1	Parameter	Shape	CrclAsp	Density	PVW
	PinP1	Setting range	Square, Circle	0.0 to 100.0	0.0 to 100.0	On, Off
		Default value	Square	0.0	100.0	Off
	PinP1 2	Parameter	Border	Width	Soft	Mode
	Border	Setting range	Off, On	0.1 to 100.0	0.0 to 100.0	Fix, Var
		Default value	Off	5.0	0.0	Fix
	PinP1 3	Parameter	Hue	Sat	Lum	Load ↓
	BodrCol	Setting range	0.0 to 359.9	0.0 to 100.0	0.0 to 108.0	White, Yellow, Cyan, Green, Magenta, Red, Blue, Black
		Default value	0.0	0.0	100.0	White
	PinP1 4	Parameter	X-Pos	Y-Pos	Size	
	Position	Setting range	-50.00 to 50.00	-50.00 to 50.00	0.00 to 100.00	
		Default value	0.00	0.00	25.00	
PinP1 5	Parameter	X	Y	Z		
Rotation	Setting range	-360 to 360	-360 to 360	-360 to 360		
	Default value	0	0	0		

8. Setting menu table

Menu	Sub menu		Parameter 1	Parameter 2	Parameter 3	Parameter 4
	Turn F1 to select.		Turn F2 to select.	Turn F3 to select.	Turn F4 to select.	Turn F5 to select.
PinP1	PinP1 6	Parameter	Trim	Manual		
	Trim	Setting range	Manual, Off, 4:3 (The setting is fixed at Off when Circle has been set for the Shape item on the PinP1 sub menu.)	Free, Pair		
		Default value	Off	Free		
	PinP1 7	Parameter	Left	Top	Bottom	Right
	TrimAdj	Setting range	-50.00 to 50.00	-50.00 to 50.00	-50.00 to 50.00	-50.00 to 50.00
		Default value	-40.00	40.00	-40.00	40.00
	PinP1 8	Parameter	Prior	Sym		
	Sync	Setting range	1over2, 2over1	Off, X, Y, Center		
Default value		1over2	Off			
PinP2	PinP2 1	Parameter	Shape		Density	PVW
	PinP2	Setting range	Square		0.0 to 100.0	On, Off
		Default value	Square (fixed)		100.0	Off
	PinP2 2	Parameter	Border	Width	Soft	Mode
	Border	Setting range	Off, On	0.1 to 100.0	0.0 to 100.0	Fix, Var
		Default value	Off	5.0	0.0	Fix
	PinP2 3	Parameter	Hue	Sat	Lum	Load ↓
	BodrCol	Setting range	0.0 to 359.9	0.0 to 100.0	0.0 to 108.0	White, Yellow, Cyan, Green, Magenta, Red, Blue, Black
		Default value	0.0	0.0	100.0	White
	PinP2 4	Parameter	X-Pos	Y-Pos	Size	
	Position	Setting range	-50.00 to 50.00	-50.00 to 50.00	0.00 to 100.00	
		Default value	0.00	0.00	25.00	
	PinP2 5	Parameter	X	Y	Z	
	Rotation	Setting range	-360 to 360	-360 to 360	-360 to 360	
		Default value	0	0	0	
	PinP2 6	Parameter	Trim	Manual		
Trim	Setting range	Manual, Off, 4:3	Free, Pair			
	Default value	Off	Free			
PinP2 7	Parameter	Left	Top	Bottom	Right	
TrimAdj	Setting range	-50.00 to 50.00	-50.00 to 50.00	-50.00 to 50.00	-50.00 to 50.00	
	Default value	-40.00	40.00	-40.00	40.00	
PinP2 8	Parameter	Prior	Sym			
Sync	Setting range	1over2, 2over1	Off, X, Y, Center			
	Default value	1over2	Off			

8. Setting menu table

Menu	Sub menu		Parameter 1	Parameter 2	Parameter 3	Parameter 4
	Turn F1 to select.		Turn F2 to select.	Turn F3 to select.	Turn F4 to select.	Turn F5 to select.
DSK1	DSK1 1	Parameter	Type	LumKey	Fill	PVW
	DSK1	Setting range	Lum, Linear	ChrmOn, ChrmOff	Bus, Matte	On, Off
		Default value	Linear	ChrmOff	Bus	Off
	DSK1 2	Parameter	Clip	Gain	Density	Invert
	Adjust	Setting range	0.0 to 108.0	0.0 to 200.0	0.0 to 100.0	On, Off
		Default value	0.0	100.0	100.0	Off
	DSK1 3	Parameter	Hue	Sat	Lum	Load ↓
	FillMatt	Setting range	0.0 to 359.9	0.0 to 100.0	0.0 to 108.0	White, Yellow, Cyan, Green, Magenta, Red, Blue, Black
		Default value	0.0	0.0	100.0	White
	DSK1 4	Parameter	Type	Width	Direc	
	Edge	Setting range	Off, Border, Drop, Shadow, Outline	0 to 4	0, 45, 90, 135, 180, 225, 270, 315	
		Default value	Off	2	0	
	DSK1 5	Parameter	Hue	Sat	Lum	Load ↓
	EdgeCol	Setting range	0.0 to 359.9	0.0 to 100.0	0.0 to 108.0	White, Yellow, Cyan, Green, Magenta, Red, Blue, Black
		Default value	0.0	0.0	0.0	Black
	DSK1 6	Parameter	Mask	Invert		
Mask	Setting range	Off, Manual, 4:3	On, Off			
	Default value	Off	Off			
DSK1 7	Parameter	Left	Top	Bottom	Right	
MaskAdj	Setting range	-50.00 to 50.00	-50.00 to 50.00	-50.00 to 50.00	-50.00 to 50.00	
	Default value	-25.00	25.00	-25.00	25.00	
DSK2	DSK2 1	Parameter	Type	LumKey	Fill	PVW
	DSK2	Setting range	Lum, Linear	ChrmOn, ChrmOff	Bus, Matte	On, Off
		Default value	Linear	ChrmOff	Bus	Off
	DSK2 2	Parameter	Clip	Gain	Density	Invert
	Adjust	Setting range	0.0 to 108.0	0.0 to 200.0	0.0 to 100.0	On, Off
		Default value	0.0	100.0	100.0	Off
DSK2 3	Parameter	Hue	Sat	Lum	Load ↓	
FillMatt	Setting range	0.0 to 359.9	0.0 to 100.0	0.0 to 108.0	White, Yellow, Cyan, Green, Magenta, Red, Blue, Black	
	Default value	0.0	0.0	100.0	White	

8. Setting menu table

Menu	Sub menu		Parameter 1	Parameter 2	Parameter 3	Parameter 4
	Turn F1 to select.		Turn F2 to select.	Turn F3 to select.	Turn F4 to select.	Turn F5 to select.
DSK2	DSK2 4	Parameter	Type	Width	Dirac	
	Edge	Setting range	Off, Border, Drop, Shadow, Outline	0 to 4	0, 45, 90, 135, 180, 225, 270, 315	
		Default value	Off	2	0	
	DSK2 5	Parameter	Hue	Sat	Lum	Load ↓
	EdgeCol	Setting range	0.0 to 359.9	0.0 to 100.0	0.0 to 108.0	White, Yellow, Cyan, Green, Magenta, Red, Blue, Black
		Default value	0.0	0.0	0.0	Black
	DSK2 6	Parameter	Mask	Invert		
	Mask	Setting range	Off, Manual, 4:3	On, Off		
		Default value	Off	Off		
	DSK2 7	Parameter	Left	Top	Bottom	Right
MaskAdj	Setting range	-50.00 to 50.00	-50.00 to 50.00	-50.00 to 50.00	-50.00 to 50.00	
	Default value	-25.00	25.00	-25.00	25.00	
TIME	TIME 1	Parameter	TransTime		Unit	
	BKGD	Setting range	0 to 33s (When 59.94 Hz is selected)	0 to 999f	Frame, Sec	
		Default value	1s	0f	Sec	
	TIME 2	Parameter	TransTime		Unit	
	KEY	Setting range	0 to 33s (When 59.94 Hz is selected)	0 to 999f	Frame, Sec	
		Default value	1s	0f	Sec	
	TIME 3	Parameter	TransTime		Unit	
	PinP1	Setting range	0 to 33s (When 59.94 Hz is selected)	0 to 999f	Frame, Sec	
		Default value	1s	0f	Sec	
	TIME 4	Parameter	TransTime		Unit	
	PinP2	Setting range	0 to 33s (When 59.94 Hz is selected)	0 to 999f	Frame, Sec	
		Default value	1s	0f	Sec	
	TIME 5	Parameter	TransTime		Unit	
	DSK1	Setting range	0 to 33s (When 59.94 Hz is selected)	0 to 999f	Frame, Sec	
		Default value	1s	0f	Sec	
	TIME 6	Parameter	TransTime		Unit	
	DSK2	Setting range	0 to 33s (When 59.94 Hz is selected)	0 to 999f	Frame, Sec	
Default value		1s	0f	Sec		
TIME 7	Parameter	TransTime		Unit	ENBL	
AUX1	Setting range	0 to 33s (When 59.94 Hz is selected)	0 to 999f	Frame, Sec	Enable, Disable	
	Default value	1s	0f	Sec	Enable	

8. Setting menu table

Menu	Sub menu		Parameter 1	Parameter 2	Parameter 3	Parameter 4
	Turn F1 to select.		Turn F2 to select.	Turn F3 to select.	Turn F4 to select.	Turn F5 to select.
TIME	TIME 8	Parameter	TransTime		Unit	
	EFF DSLV	Setting range	0 to 33s (When 59.94 Hz is selected)	0 to 999f	Frame, Sec	
		Default value	1s	0f	Sec	
	TIME 9	Parameter	TransTime		Unit	
	FTB	Setting range	0 to 33s (When 59.94 Hz is selected)	0 to 999f	Frame, Sec	
		Default value	1s	0f	Sec	
CBGD	CBGD 1	Parameter	Hue	Sat	Lum	Load ↓
	CBGD	Setting range	0.0 to 359.9	0.0 to 100.0	0.0 to 108.0	White, Yellow, Cyan, Green, Magenta, Red, Blue, Black
		Default value	0.0	0.0	100.0	White
BKGD	BKGD 1	Parameter	Border	Width	Soft	
	Border	Setting range	On, Off	0.1 to 100.0	0.0 to 100.0 ● “-” is displayed when the SQ2, SL2 or 3D2 wipe pattern for the background transition has been selected using the [BKGD PATT] button.	
		Default value	Off	5.0	0.0	
	BKGD 2	Parameter	Hue	Sat	Lum	Load ↓
	BodrCol	Setting range	0.0 to 359.9	0.0 to 100.0	0.0 to 108.0	White, Yellow, Cyan, Green, Magenta, Red, Blue, Black
		Default value	0.0	0.0	100.0	White
	BKGD 3	Parameter	X-Pos	Y-Pos		CopyTo ↓
	WIPEPos	Setting range	-100.00 to 100.00	-100.00 to 100.00		Display only
		Default value	0.00	0.00		
	BKGD 4	Parameter	X-Pos	Y-Pos		CopyTo ↓
	SQPos	Setting range	-100.00 to 100.00	-100.00 to 100.00		Display only
Default value		0.00	0.00			
BKGD 5	Parameter	Light	Trim	4:3Auto		
Modify	Setting range	On, Off	Off, 16:9 (On), 4:3, 4:3Smth	On, Off (Selection enabled when HD format is used)		
	Default value	Off	Off	Off		
BKGD 6	Parameter	Type				
Base	Setting range	FMEM1 to 4, Black, CBGD				
	Default value	Black				

8. Setting menu table

Menu	Sub menu		Parameter 1	Parameter 2	Parameter 3	Parameter 4
	Turn F1 to select.		Turn F2 to select.	Turn F3 to select.	Turn F4 to select.	Turn F5 to select.
IMAG A	IMAG A 1	Parameter	On/Off			
	IMAG A	Setting range Default value	On, Off Off			
	IMAG A 2	Parameter	On/Off	Y-Level	C-Level	
	Paint	Setting range Default value	On, Off Off	0 to 7 0	0 to 7 0	
	IMAG A 3	Parameter	On/Off	Hue	Sat	
	Mono	Setting range Default value	On, Off Off	0.0 to 359.9 0.0	0.0 to 100.0 0.0	
	IMAG A 4	Parameter	On/Off	Mode	Effect	
	Mosa/Def	Setting range Default value	On, Off Off	Mosaic, Defocus Mosaic	0.0 to 100.0 20.0	
IMAG B	IMAG B 1	Parameter	On/Off			
	IMAG B	Setting range Default value	On, Off Off			
	IMAG B 2	Parameter	On/Off	Y-Level	C-Level	
	Paint	Setting range Default value	On, Off Off	0 to 7 0	0 to 7 0	
	IMAG B 3	Parameter	On/Off	Hue	Sat	
	Mono	Setting range Default value	On, Off Off	0.0 to 359.9 0.0	0.0 to 100.0 0.0	
	IMAG B 4	Parameter	On/Off	Mode	Effect	
	Mosa/Def	Setting range Default value	On, Off Off	Mosaic, Defocus Mosaic	0.0 to 100.0 20.0	
FMEM	FMEM 1	Parameter	FMEM	Select	Review	Exec ↓
	AUX	Setting range Default value	FMEM1 to 4 FMEM1	AUX1 to 4 AUX1	On, Off Off	
	FMEM 2	Parameter	Mode	Select		Exec ↓
	Memory	Setting range Default value	AUTO, Manual AUTO	FMEM1 to 4, ALL ALL		
SDCard	SDCard 1	Parameter	Mode ↓	Select	SaveFile	Exec ↓
	File	Setting range Default value	*Load, Save, Init, Delete, No Card —	FMEM1 to 4, SetUp —	HS001 —	
	SDCard 2	Parameter	Images	FreeSpace		GetInf ↓
	CardInfo	Setting range Default value		MB/ MB		
CTL	CTL 1	Parameter	Edit-EN	COM-EN		
	RS422	Setting range Default value	Enable, Disable Enable	Enable, Disable Enable		

8. Setting menu table

Menu	Sub menu		Parameter 1	Parameter 2	Parameter 3	Parameter 4
	Turn F1 to select.		Turn F2 to select.	Turn F3 to select.	Turn F4 to select.	Turn F5 to select.
CAM	CAM 1	Parameter	CTL	Signal	Tally	Protocol
	CamCTL1	Setting range	1 to 5	IN1 to 16, IN-A1, IN-A2, IN-B1, IN-B2, None	Enable, Disable	P/TCont, P/TDirt
		Default value	1	None	Disable	P/TCont
	CAM 2	Parameter	CTL	PosCont	PTSpeed	Power ↓
	CamCTL2	Setting range	1 to 5	PanTilt, Zm/Focs	Fast, Middle, Slow	On, Off
		Default value	1	PanTilt	Fast	On
	CAM 3	Parameter	CTL	C-Menu ↓	Item	Val/Y/N
	CamMenu	Setting range	1 to 5	On, Off	Cursor	Cursor
		Default value	1	—	—	—
XPT	XPT 1	Display only	XPT: 1 2 3 4 5 6 7 8			
	Status1		SIG: BK 1 2 3 4 5 6 7			
	XPT 2	Display only	XPT: 9 10 11 12 13 14 15 16			
	Status2		SIG: 8 9 10 11 12 13 14 Sf			
	XPT 3	Display only	XPT: 17 18 19 20 21 22 23 24			
	Status3		SIG: 15 16 A1 A2 B1 B2 - -			
	XPT 4	Display only	XPT: 25 26 27 28 29 30 31 32			
	Status4		SIG: - PG PV KO CL M1 M2 Sf			
	XPT 5	Parameter	XPT	Signal	Shift	Sf-Lock
	XPTAsign	Setting range	1 to 32	IN1 to 16, IN-A1, IN-A2, IN-B1, IN-B2, Black, CBGD, CBAR, FMEM1 to 4, PGM, PVW, CLN, MV1, MV2 (AUX bus only), None	Off, Right, Left	On, Off
		Default value	—	—	Right	Off
	XPT 6	Parameter	Timing			
	XPT Swch	Setting range	Any_Field1, Field2			
		Default value	Any			

8. Setting menu table

Menu	Sub menu		Parameter 1	Parameter 2	Parameter 3	Parameter 4
	Turn F1 to select.		Turn F2 to select.	Turn F3 to select.	Turn F4 to select.	Turn F5 to select.
MV	MV 1	Parameter	Split		Pos	Signal
	MV1 PATT	Setting range	16Split, 10Split, 9Split, 4Split (The screen can be split into a total of up to 20 screens when the number of MV1 split screens and number of MV2 split screens are combined.)		1 to 16, 1 to 10, 1 to 8, 1 to 4	IN1 to 16, IN-A1, IN-A2, IN-B1, IN-B2, CBGD, FMEM1 to 4, PGM, PVW, KeyOut, AUX1 to 4
		Default value	10Split		1	IN1 to 10
	MV 2	Parameter	Frame	Char	Label	Tally
	MV1Frame	Setting range	LUM 0%, LUM25%, LUM50%, LUM75%, LUM100%, Off	LUM 0%, LUM25%, LUM50%, LUM75%, LUM100%, Off	On, Off	Red, Red+GRN, Off
		Default value	LUM75%	LUM75%	On	Red+GRN
	MV 3	Parameter	Split		Pos	Signal
	MV2 PATT	Setting range	16Split, 10Split, 9Split, 4Split (The screen can be split into a total of up to 20 screens when the number of MV1 split screens and number of MV2 split screens are combined.)		1 to 16, 1 to 10, 1 to 8, 1 to 4	IN1 to 16, IN-A1, IN-A2, IN-B1, IN-B2, CBGD, FMEM1 to 4, PGM, PVW, KeyOut, AUX1 to 4
		Default value	10Split		1	IN1 to 10
	MV 4	Parameter	Frame	Char	Label	Tally
MV2Frame	Setting range	LUM 0%, LUM25%, LUM50%, LUM75%, LUM100%, Off	LUM 0%, LUM25%, LUM50%, LUM75%, LUM100%, Off	On, Off	Red, Red+GRN, Off	
	Default value	LUM75%	LUM75%	On	Red+GRN	

8. Setting menu table

Menu	Sub menu	Third menu		Parameter 1	Parameter 2	Parameter 3	
	Turn F1 to select.	Turn F2 to select.		Turn F3 to select.	Turn F4 to select.	Turn F5 to select.	
INPUT	INPUT XX* (SDI) * IN1 to IN16, A1, A2, B1 or B2 is displayed for X.	FS	Parameter	FS	Mode ↓	CC	
		1/13	Setting range	On, Off	*Normal, DbyD, UC, Auto	On, Off	
			Default value	On	Normal	Off	
		Freeze	Parameter	Select	Freeze ↓		
		2/13	Setting range	Frame, Field	Toggle between On and Off		
			Default value	Frame	Off		
		Name	Parameter	Type ↓	Name		
		3/13	Setting range	*Default, Preset, User			
			Default value	Default			
		UpConv1	Parameter	Scale ↓	MovDet ↓	Sharp ↓	
		4/13 (IN13 to IN16, A1, A2, B1 or B2 only)	Setting range	*SQ, EC, LB,	*1 to 5	*1 to 5	
			Default value	SQ	3	3	
		UpConv2	Parameter	EC-Pos			
		5/13 (IN13 to IN16 only)	Setting range	Center, Right, Left			
			Default value	Center			
		CC	Parameter	ClorCnv	Limiter	CLEAR ↓	
		6/13 (IN9 to IN16 only)	Setting range	On, Off	Off, 108, 104, 100	Prc, Trn, MTX, ALL	
			Default value	On	100	ALL	
		CC Prc1	Parameter	Y-Gain	Slice		
		7/13 (IN9 to IN16 only)	Setting range	0.0 to 200.0	-7.0 to 108.0		
			Default value	100.0	0.0		
		CC Prc2	Parameter	C-Gain	Hue		
		8/13 (IN9 to IN16 only)	Setting range	0.0 to 200.0	0.0 to 359.9		
			Default value	100.0	0.0		
		CC Trn1	Parameter	RGB	Manual	GrayPos	
		9/13 (IN9 to IN16 only)	Setting range	R, G, B	Free, ALL	0.25 to 0.75	
	Default value	R	ALL	0.50			
CC Trn2	Parameter	BlackLv	GrayLv	WhiteLv			
10/13 (IN9 to IN16 only)	Setting range	0.00 to 0.50	0.25 to 0.75	0.50 to 1.00			
	Default value	0.00	0.50	1.00			
CC MTX1	Parameter	R-G	R-B				
11/13 (IN9 to IN16 only)	Setting range	-1.00 to 1.00	-1.00 to 1.00				
	Default value	0.00	0.00				
CC MTX2	Parameter	G-R	G-B				
12/13 (IN9 to IN16 only)	Setting range	-1.00 to 1.00	-1.00 to 1.00				
	Default value	0.00	0.00				
CC MTX3	Parameter	B-R	B-G				
13/13 (IN9 to IN16 only)	Setting range	-1.00 to 1.00	-1.00 to 1.00				
	Default value	0.00	0.00				

8. Setting menu table

Menu	Sub menu	Third menu		Parameter 1	Parameter 2	Parameter 3
	Turn F1 to select.	Turn F2 to select.		Turn F3 to select.	Turn F4 to select.	Turn F5 to select.
INPUT	INPUT XX* (ANA) * A1, A2, B1 or B2 is displayed for X.	FS	Parameter	FS	Mode ↓	AnaGain
		1/4	Setting range	On, Off	*Normal, DbyD, UC, Auto	-30 to +30
			Default value	On	Normal	0
		Freeze	Parameter	Select	Freeze ↓	
		2/4	Setting range	Frame, Field	Toggle between On and Off	
			Default value	Frame	Off	
		Name	Parameter	Type ↓	Name	
	3/4	Setting range	*Default, Preset, User			
		Default value	Default			
	UpConv1	Parameter	Scale ↓	MovDet ↓	Sharp ↓	
	4/4	Setting range	*SQ, EC, LB	*1 to 5	*1 to 5	
		Default value	SQ	3	3	
	INPUT XX* (DVI) * A1, A2, B1 or B2 is displayed for X.	Freeze	Parameter	Select	Freeze ↓	
		1/4	Setting range	Frame, Field	Toggle between On and Off	
			Default value	Frame	Off	
		Name	Parameter	Type ↓	Name	
		2/4	Setting range	*Default, Preset, User		
			Default value	Default		
DVIIn		Parameter	Mode	Scale	Auto ↓	
3/4	Setting range	*Dig, Ana ("Ana" can be selected when the AV-HS04M3 option board has been connected.)	Fit-V, Fit-H, Full	Black, White, Init ("Ana" can be selected when the AV-HS04M3 option board has been connected.)		
	Default value	Dig	Fit-V	Black		
DVIPhs	Parameter	ClkPhs	H-Pos	V-Pos		
4/4	Setting range	-16 to 15	-100 to 100	-100 to 100		
	Default value	0	0	0		

8. Setting menu table

Menu	Sub menu	Third menu		Parameter 1	Parameter 2	Parameter 3
	Turn F1 to select.	Turn F2 to select.		Turn F3 to select.	Turn F4 to select.	Turn F5 to select.
INPUT	INPUT XX* (Csit) * A1, A2, B1 or B2 is displayed for X.	FS	Parameter	FS	Mode ↓	AnaGain
		1/5	Setting range	On, Off	*Normal, DbyD, UC, Auto	-30 to +30
			Default value	On	Normal	0
		Freeze	Parameter	Select	Freeze ↓	
		2/5	Setting range	Frame, Field	Toggling between On and Off	
			Default value	Frame	Off	
		Name	Parameter	Type ↓	Name	
		3/5	Setting range	*Default, Preset, User		
			Default value	Default		
		UpConv1	Parameter	Scale ↓	MovDet ↓	Sharp ↓
4/5	Setting range	SQ, EC, LB	1 to 5	1 to 5		
	Default value	SQ	3	3		
	Setting	Parameter	Chroma	Ped	Hue	
5/5	Setting range	-8 to +7	-100 to +100	-30 to +30 (Enabled when the system format is set to 1080/59.94i, 720/59.94p and 480/59.94i.)		
		Default value	0	0	0	
OUTPUT	OUTPUTYY* (SDI) * Out1 to 4, A1, A2, B1 or B2 is displayed for Y.	Assign	Parameter	Source	Mode ↓	
		1/2	Setting range	PGM, PVW, CLN, AUX1 to 4, MV1 to 2, KeyOut	*Normal, DC	
			Default value	—	Normal	
		DownCnv	Parameter	Scale ↓	Delay ↓	Sharp ↓
		2/2 (This submenu is available when the AV-HS04M7 option board has been connected.)	Setting range	*SQ, EC, LB	*90H(75H), 1F	*1 to 5
	Default value	SQ	90H	3		
	OUTPUTYY* (ANA)	Assign	Parameter	Source		
1/1	Setting range	PGM, PVW, CLN, AUX1 to 4, MV1 to 2, KeyOut				
	(This submenu is available when the AV-HS04M7 option board has been connected.)	Default value	—			

8. Setting menu table

Menu	Sub menu	Third menu		Parameter 1	Parameter 2	Parameter 3
	Turn F1 to select.	Turn F2 to select.		Turn F3 to select.	Turn F4 to select.	Turn F5 to select.
OUTPUT	OUTPUTYY* (DVI-D) * Out5 to 6 is displayed for Y.	Assign	Parameter	Source	MovDet ↓	
		1/2	Setting range	PGM, PVW, CLN, AUX1 to 4, MV1 to 2, KeyOut	1 to 5	
			Default value	—	3	
		DVIOut	Parameter		Size ↓	Scale ↓
	2/2	Setting range		*Auto, XGA, WXGA, SXGA, WSXGA+, UXGA, WUXGA	*Fit-V, Fit-H, Full	
		Default value		Auto	Fit-V	
	OUTPUTYY* (DVI-I) * A1, A2, B1 or B2 is displayed for Y. (This submenu is available when the AV-HS04M5 option board has been connected.)	Assign	Parameter	Source		
		1/2	Setting range	PGM, PVW, CLN, AUX1 to 4, MV1 to 2, KeyOut		
		Default value	—			
DVIOut		Parameter	Mode ↓	Size ↓	Scale ↓	
2/2	Setting range	*Dig, Ana	*Auto, XGA, WXGA, SXGA, WSXGA+, UXGA, WUXGA	*Fit-V, Fit-H, Full		
	Default value	Dig	Auto	Fit-V		

8. Setting menu table

Menu	Sub menu		Parameter 1	Parameter 2	Parameter 3	Parameter 4
	Turn F1 to select.		Turn F2 to select.	Turn F3 to select.	Turn F4 to select.	Turn F5 to select.
CONFIG	CONFIG 1	Parameter	BusMode	LCD-BL	MENUDLG	
	Operate	Setting range	A/B, PGM/PST	On, Off, 60, 120, 180	On, Off	
		Default value	PGM/PST	On	On	
	CONFIG 2	Parameter	LEDMode			
	SHOT MEM	Setting range	AW, AV			
		Default value	AV			
	CONFIG 3	Parameter	ENBL			
	SYSCONF	Setting range	Enable, Disable (When Disable is selected, the system menu is locked.)			
		Default value	Disable			
	CONFIG 4	Parameter	Port	Assign		GPIEN
	GPIM-In	Setting range	Port1 to 8	AUTO, CUT, DSK1, DSK2, PinP1, PinP2, FTB, BGDAUTO, BGDCUT, KEYAUTO, KEYCUT, RTlyDBL, GTlyDBL, NoAssign		Enable, Disable
		Default value	—	NoAssign		Enable
	CONFIG 5	Parameter	Port	Assign		GPIEN
	GPIM-Out	Setting range	Port1 to 31	AUTO, CUT, DSK1ON, DSK2ON, PinP1ON, PinP2ON, FTBON, BGDAUTO, BGDCUT, KEYAUTO, KEYCUT, DSK1TRN, DSK2TRN, PinP1TR, PinP2TR, FTBTRN, KEYON, KEYTRN, R-Tly1 to 20, G-Tly1 to 20, NoAssign		Enable, Disable
Default value		—	NoAssign		Disable	

8. Setting menu table

Menu	Sub menu		Parameter 1	Parameter 2	Parameter 3	Parameter 4
	Turn F1 to select.		Turn F2 to select.	Turn F3 to select.	Turn F4 to select.	Turn F5 to select.
CONFIG	CONFIG 6	Parameter	Port	Assign		GPIEN
	GPIP-In	Setting range	Port1 to 8	AUTO, CUT, DSK1, DSK2, PinP1, PinP2, FTB, BGDAUTO, BGDCUT, KEYAUTO, KEYCUT, RTlyDBL, GTlyDBL, NoAssign		Enable, Disable
		Default value	—	NoAssign		Disable
	CONFIG 7	Parameter	Port	Assign		GPIEN
	GPIP-Out	Setting range	Port1 to 8	AUTO, CUT, DSK1ON, DSK2ON, PinP1ON, PinP2ON, FTBON, BGDAUTO, BGDCUT, KEYAUTO, KEYCUT, DSK1TRN, DSK2TRN, PinP1TR, PinP2TR, FTBTRN, KEYON, KEYTRN, R-Tly1 to 20, G-Tly1 to 20, NoAssign		Enable, Disable
		Default value	—	NoAssign		Disable

8. Setting menu table

Menu	Sub menu		Parameter 1	Parameter 2	Parameter 3	Parameter 4
	Turn F1 to select.		Turn F2 to select.	Turn F3 to select.	Turn F4 to select.	Turn F5 to select.
CONFIG	CONFIG 8	Parameter	USER1	USER2	USER3	
	Button1	Setting range	PinPPVW, DSK1PVW, DSK2PVW, Edit-EN, COM-EN, GPIMIEN, GPIMOEN, GPIPIEN, GPIPOEN, OSD, StrFM1, StrFM2, StrFM3, StrFM4, SHIFT, AUX TRAN, None	PinPPVW, DSK1PVW, DSK2PVW, Edit-EN, COM-EN, GPIMIEN, GPIMOEN, GPIPIEN, GPIPOEN, OSD, StrFM1, StrFM2, StrFM3, StrFM4, SHIFT, AUX TRAN, None	PinPPVW, DSK1PVW, DSK2PVW, Edit-EN, COM-EN, GPIMIEN, GPIMOEN, GPIPIEN, GPIPOEN, OSD, StrFM1, StrFM2, StrFM3, StrFM4, SHIFT, AUX TRAN, None	
		Default value	PinPPVW	DSK1PVW	OSD	
	CONFIG 9	Parameter	USER4	USER5	USER6	
	Button2	Setting range	PinPPVW, DSK1PVW, DSK2PVW, Edit-EN, COM-EN, GPIMIEN, GPIMOEN, GPIPIEN, GPIPOEN, OSD, StrFM1, StrFM2, StrFM3, StrFM4, SHIFT, AUX TRAN, None	PinPPVW, DSK1PVW, DSK2PVW, Edit-EN, COM-EN, GPIMIEN, GPIMOEN, GPIPIEN, GPIPOEN, OSD, StrFM1, StrFM2, StrFM3, StrFM4, SHIFT, AUX TRAN, None	PinPPVW, DSK1PVW, DSK2PVW, Edit-EN, COM-EN, GPIMIEN, GPIMOEN, GPIPIEN, GPIPOEN, OSD, StrFM1, StrFM2, StrFM3, StrFM4, SHIFT, AUX TRAN, None	
		Default value	Edit-EN	StrFM1	SHIFT	
	CONFIG10	Parameter	OSD	Select		
	OSD	Setting range	On, Off	PVW, MV1, MV2, MV1+MV2		
		Default value	On	PVW		
	CONFIG11	Parameter	Fill	Source ↓		
	KSAsign	Setting range	IN1 to 16, IN-A1, IN-A2, IN-B1, IN-B2, CBGD, CBAR, FMEM1 to 4	IN1 to 16, IN-A1, IN-A2, IN-B1, IN-B2, CBGD, CBAR, FMEM1 to 4, NoAsign		
		Default value	—	(Same as Fill)		
CONFIG12	Parameter	CLN				
CLNAsign	Setting range	KEY, DSK1, DSK2				
	Default value	KEY				

8. Setting menu table

Menu	Sub menu		Parameter 1	Parameter 2	Parameter 3	Parameter 4
	Turn F1 to select.		Turn F2 to select.	Turn F3 to select.	Turn F4 to select.	Turn F5 to select.
SYSTEM (When locked)	(Message)	Parameter	The SYSTEM menu is locked.			
		Display only				
SYSTEM (When unlocked)	SYS 1	Parameter	Mode ↓	HiRes ↓	16:9SQ	
	Format	Setting range	*1080/59.94i, 1080/50i, 1080/24psf, 1080/23.98psf, 720/59.94p, 720/50p, 480/59.94i, 576/50i	On, Off (Selection enabled when SD format is used)	On, Off (Selection enabled when SD format is used)	
		Default value	1080/59.94i	Off	Off	
	SYS 2	Parameter	System	H-Phase	V-Phase	
	OutPhs	Setting range	0H, 1H	-1320 to +1319	-100 to +100	
		Default value	1H	0	0	
	SYS 3	Parameter	Sync ↓	BBSetup	GenLock	
	Ref	Setting range	*BBST, BBAD, TRI, INT	0IRE, 7.5IRE	Locked, UnLock	
		Default value	BBST	7.5IRE	—	
	SYS 4	Parameter	VAnci	E.Audio		
	Anci	Setting range	On, Off	On, Off		
		Default value	Off	Off		
	SYS 5	Parameter	Power	Fan		
	Alarm	Setting range	Alarm, NoAlarm	Alarm, NoAlarm		
		Default value	Alarm	Alarm		
	SYS 6	Parameter	Init ↓	F Init ↓		
	Initial	Setting range				
		Default value				
	SYS 7	Parameter	IP Address			Save ↓
	NetWork1	Setting range	0 to 255	0 to 255	0 to 255	0 to 255
		Default value	192	168	0	10
SYS 8	Parameter	Subnet Mask			Save ↓	
NetWork2	Setting range	0 to 255	0 to 255	0 to 255	0 to 255	
	Default value	255	255	255	0	
SYS 9	Parameter	MAC Address				
NetWork3	Display only					
SYS 10	Parameter	Year	Month	Date	Set ↓	
Date	Setting range	2000 to 2099	1 to 12	1 to 31	—	
	Default value	—	—	—	—	
SYS 11	Parameter	Hour	Minute	Second	Set ↓	
Time	Setting range	0 to 23	0 to 59	0 to 59	—	
	Default value	—	—	—	—	

8. Setting menu table

Menu	Sub menu		Parameter 1	Parameter 2	Parameter 3	Parameter 4
	Turn F1 to select.		Turn F2 to select.	Turn F3 to select.	Turn F4 to select.	Turn F5 to select.
SYSTEM (When unlocked)	SYS 12	Parameter	Select	Version		SysVer
	MainVer	Setting range	MFSOft, PnlSOft, PnlFPGA, CntFPGA, In1FPGA, In2FPGA, M/EFPGA, OutFPGA	Version number		Version number
		Default value	MFSOft			
	SYS 13	Parameter	Select	Board	Version	
	OptVer	Setting range	SLOTA, SLOTB	SDI-IN, Ana-IN, DVI-IN, DVID-IN, SDI-OUT, Ana-OUT, D/A-OUT, Csit-IN, None	Version number	
		Default value	SLOTA			

9. Appearance

Mainframe

Unit: inch (mm)

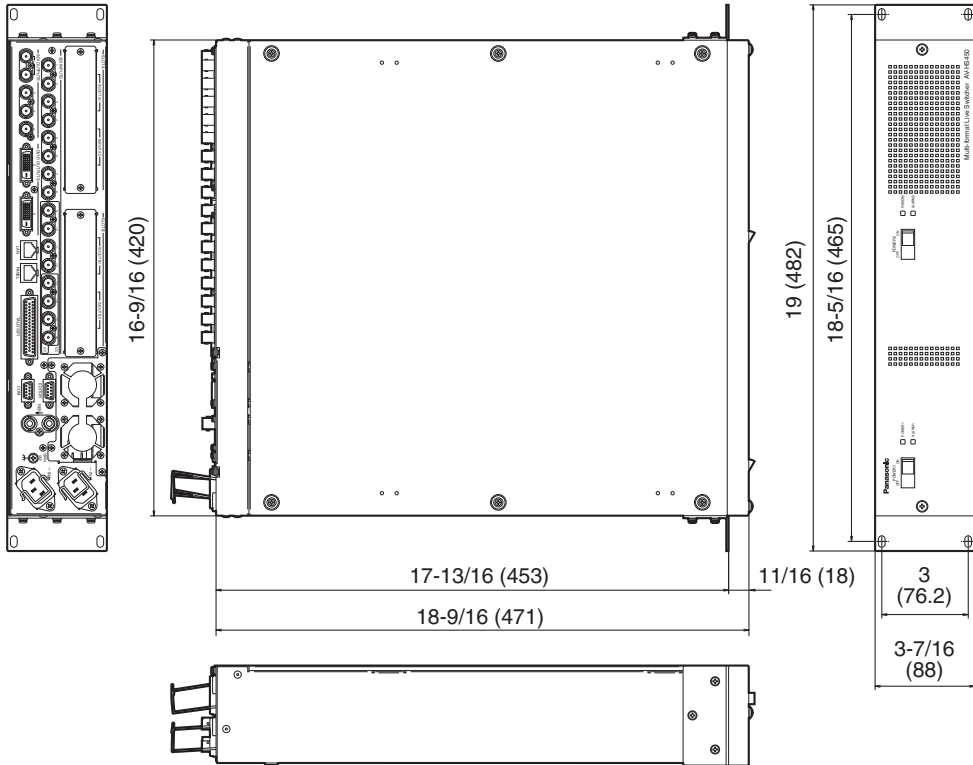

Control panel

Unit: inch (mm)

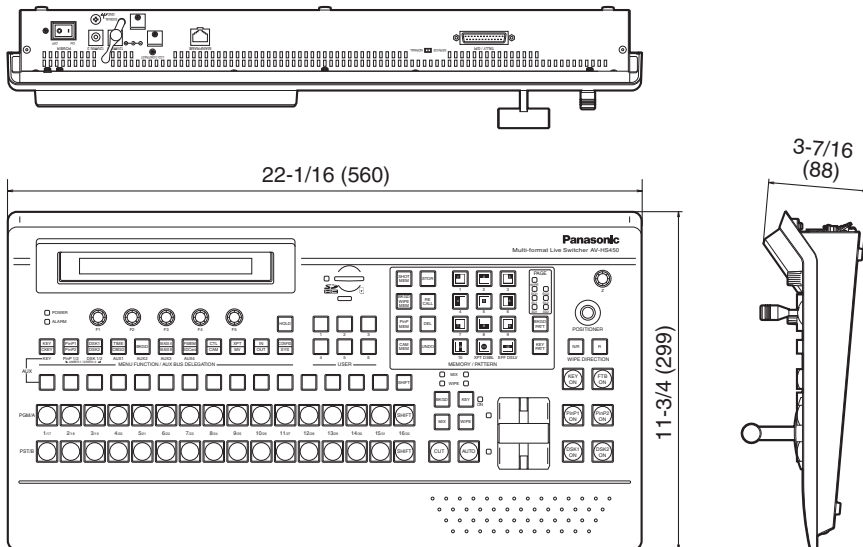

10. Specifications

■ Mainframe [AV-HS450U1N]

Video inputs (20 signal lines, maximum)	Standard SDI: 16 signal lines (IN1 to IN16)	BNC ×16
	Optional: Up to 4 additional signal lines (IN A1, IN A2, IN B1, IN B2) (Up to two option boards can be installed in the two input/output slots.)	
Video outputs (10 signal lines, maximum)	Standard SDI: 4 signal lines (OUT1 to OUT4 ×1 line each, 2 distributed outputs for OUT1 only)	BNC ×5
	Standard DVI-D: 2 signal lines (OUT5, OUT6)	DVI-D ×2
	Optional: Up to 4 additional lines (OUT A1, OUT A2, OUT B1, OUT B2) (Up to two option boards can be installed in the two input/output slots.)	
	<ul style="list-style-type: none"> ● PGM, PVW, AUX1 to AUX4, MV1 (MULTI-PVW1), MV2 (MULTI-PVW2), CLN and KEYOUT can be allocated to each output. ● CLN can be pre-selected from KEY, DSK1 or DSK2 using a menu. 	
Signal formats	SD	480/59.94i, 576/50i
	HD	1080/59.94i, 1080/50i, 720/59.94p, 720/50p, 1080/24PsF *, 1080/23.98PsF * *: The following option boards are not supported: AV-HS04M1, AV-HS04M2, AV-HS04M3, AV-HS04M4, AV-HS04M5, AV-HS04M6, AV-HS04M7
Signal processing	Y:Cb:Cr 4: 2: 2, 10 bit (8 bits for frame memory) RGB 4:4:4, 8 bit	
ME number	1ME	
SDI inputs	HD: Serial digital component (SMPTE 292M) SD: Serial digital component (SMPTE 259M)	
	16 signal lines, standard: IN1 to IN16 20 signal lines, maximum: IN A1, IN A2, IN B1, IN B2 (When two AV-HS04M1 boards are used; with active through)	
	HD [SMPTE 292M (BTA S-004B) standard complied with] <ul style="list-style-type: none"> • 0.8 Vp-p ±10 % (75 Ω) • Input return loss More than 15 dB (5 MHz to 750 MHz) More than 10 dB (750 MHz to 1.5 GHz) • Automatic equalizer 328 ft. (100 m) (when 5C-FB cable is used) 	
	SD [SMPTE 259M standard complied with] <ul style="list-style-type: none"> • 0.8 Vp-p ±10 % (75 Ω) • Input return loss More than 15 dB (5 MHz to 270 MHz) • Automatic equalizer 656 ft. (200 m) (when 5C-2V cable is used) 	

10. Specifications

SDI outputs	HD: Serial digital component (SMPTE 292M) SD: Serial digital component (SMPTE 259M)
	4 signal lines, standard: OUT1 ×2; OUT2, OUT3, OUT4 ×1 each 8 signal lines, maximum: OUT A1, OUT A2, OUT B1, OUT B2 (When two AV-HS04M7 boards are used)
	HD [SMPTE 292M (BTA S-004B) standard complied with] <ul style="list-style-type: none"> • Output return loss More than 15 dB (5 MHz to 750 MHz) More than 10 dB (750 MHz to 1.5 GHz) • Output level 0.8 Vp-p ±10 % (75 Ω) • Rise time Less than 270 ps • Fall time Less than 270 ps • Difference between rise time and fall time Less than 100 ps • Alignment jitter Less than 0.2 UI (130 ps) • Timing jitter Less than 1.0 UI • Eye aperture ratio More than 90 % • DC offset 0 ±0.5 V
	SD [SMPTE 259M standard complied with] <ul style="list-style-type: none"> • Output return loss More than 15 dB (5 MHz to 270 MHz) • Output level 0.8 Vp-p ±10 % (75 Ω) • Rise time Less than 1.5 ns • Fall time Less than 1.5 ns • Difference between rise time and fall time Less than 0.5 ns • Jitter Less than 0.2 UI
Composite input (option)	Analog composite signal (NTSC/PAL) (1.0 Vp-p, 75 Ω)
	4 signal lines, maximum: IN A1, IN A2, IN B1, IN B2 (When two AV-HS04M6 boards are used; with loop-through)
Analog input (option)	SD/HD analog component Y/Pb/Pr (1.0 Vp-p, 75 Ω)
	4 signal lines, maximum: IN A1, IN A2, IN B1, IN B2 (When two AV-HS04M2 boards are used)
Analog output (option)	SD/HD analog component Y/Pb/Pr (1.0 Vp-p, 75 Ω)
	4 signal lines, maximum: OUT A1, OUT A2, OUT B1, OUT B2 (When two AV-HS04M4 boards are used)
	• 2 signal lines (OUT A1, OUT B1) when two AV-HS04M5 boards are used
DVI-I input (option)	Analog/digital RGB: XGA (1024×768), WXGA (1280×768), SXGA (1280×1024) Vertical frequency: 60 Hz
	4 signal lines, maximum: IN A1, IN A2, IN B1, IN B2 (When two AV-HS04M3 boards are used)
DVI-I output (option)	Analog/digital RGB: XGA (1024×768), WXGA (1280×768), SXGA (1280×1024), WSXGA+ * (1680×1050), UXGA * (1600×1200), WUXGA * (1920×1200) (*: Selectable only when digital signals are output) Vertical frequency: 60 Hz
	2 signal lines, maximum: OUT A2, OUT B2 (When two AV-HS04M5 boards are used)

10. Specifications

DVI-D input (option)	Digital RGB: XGA (1024×768), WXGA (1280×768), SXGA (1280×1024), WSXGA+ (1680×1050), UXGA (1600×1200), WUXGA (1920×1200) Vertical frequency: 60 Hz Digital RGB: 1080/50P, 1080/59.94P ● Analog input signals are not supported.	
	4 signal lines, maximum: IN A1, IN A2, IN B1, IN B2 (When two AV-HS04M8 boards are used) ● The DVI-I connector cable cannot be used. ● For the DVI-D connector cable, use a cable with a length of up to 5 m.	
DVI-D output	Digital RGB: XGA (1024×768), WXGA (1280×768), SXGA (1280×1024), WSXGA+ (1680×1050), UXGA (1600×1200), WUXGA (1920×1200) Vertical frequency: 60 Hz Digital RGB: 1080/50P, 1080/59.94P ● Analog output signals are not supported. ● High-resolution multi view mode supported: Signals are also output with a high resolution even when SD has been selected as the system mode. With this mode setting, MV1 is output to OUT5 and MV2 to OUT6; MV1 and MV2 cannot be output to any other outputs.	
	2 lines, standard: OUT5, OUT6 ● The DVI-I connector cable cannot be used. ● For the DVI-D connector cable, use a cable with a length of up to 5 m.	
Reference input/output	In gen-lock mode: Black burst or Tri-level Sync input signals (with loop-through) In internal sync mode: Black burst output signals ×2 ● Same field frequencies as those of the system formats supported ● With the 1080/23.98PsF and 24PsF formats, only GENLOCK mode supported ● With the 1080/23.98PsF format, black burst with 10F-ID (SMPTE318M standard met) or TRI signals supported	
Video delay time	FS OFF, U/C OFF	1 line (H)
	FS ON or U/C ON	1 frame (F)
● When the signals have passed through DVE, multi view, down-converter, DVI-IN or DVI-OUT, a maximum delay of 1 frame is applied in each case.		

10. Specifications

Control I/O	PANEL	100 Mbps × 1 ● When the control panel is connected	RJ45
	LAN	100/10 Mbps × 1 ● Used for maintenance purposes	RJ45
	EDITOR	RS-422 control connector ● GVG standard protocol subset supported	D-sub, 9-pin, female
	COM	RS-422 control connector ● For Panasonic pan-tilt head system control, etc.	D-sub, 9-pin, female
	TALLY/GPI	INPUT: 8 inputs, general-purpose, photocoupler sensing OUTPUT: 31 outputs; selected from R/G tally, general-purpose ALARM: 1 output, open collector output (negative logic)	D-sub, 50-pin, female
Ambient operating temperature	32 °F to 104 °F (0 °C to 40 °C)		
Humidity	10 % to 90 % (no condensation)		
Power supply	AC 100 V - 120 V, 50/60 Hz ● Redundant power supply standard supported		AC inlets × 2
	Power consumption	120 W	
Dimensions (W × H × D)	2RU size 19"×3-7/16"×18-9/16" (482×88×471 mm) [excluding protrusions]		
Weight	21.56 lbs. (9.8 kg) [excluding accessory parts when no options have been installed] 22.66 lbs. (10.3 kg) [excluding accessory parts when all the possible options have been installed]		

10. Specifications

■ Control panel [AV-HS450C1N]

Control I/O	MAINFRAME	100 Mbps ×1 ● For connecting the mainframe	RJ45
	TALLY/GPI	INPUT: 8 inputs OUTPUT: 8 outputs ALARM: 1 output	D-sub, 25-pin, female
External media	SD memory cards	Memory size supported: Max. 32 GB (SDHC memory cards supported) Still image files: Load, save Setup data: Backup	
Ambient operating temperature	32 °F to 104 °F (0 °C to 40 °C)		
Humidity	10 % to 90 % (no condensation)		
Power supply	DC 12 V, 0.8 A ● Redundant operation enabled by connecting two AC adapters ● Power consumption when using the AC adaptor: AC 14 W		DC jacks ×2
	Supplied AC adaptor Rated input: AC 100 V to 240 V, 1.5 A, 50/60 Hz Rated output: DC 12 V, 2.5 A, 30 W Supplied power cord Maximum rating: AC 125 V ● Use within AC 100 V to 120 V.		
Dimensions (W × H × D)	22-1/16"×3-7/16"×11-3/4" (560×88×299 mm) [excluding protrusions]		
Weight	8.58 lbs. (3.9 kg) [excluding accessory parts]		

Appendix (glossary)

Defined below are the terms used in this manual.

Word	Explanation
AB Bus system	A bus control mode. By executing a transition, the A bus and B bus signals are output to the program images alternately.
Ancillary Data	The auxiliary data other than the video signals which is transmitted inside the data stream of the video serial interface. The data superimposed on the vertical blanking period is referred to as the V ancillary data (VANC).
Aspect ratio	The ratio between the horizontal and vertical dimensions of an image or screen. It is 16:9 for the HD format and 4:3 for the SD format.
AUX [Auxiliary Bus]	A spare bus which can be switched by signals other than the main line output signals.
AVDL [Automatic Video Delayline]	A function to automatically adjust the input image signal phase to the horizontal synchronization reference signal phase.
BB [Black burst]	The black burst signal. A full-screen black level composite signal which is used as the reference signal for gen-lock.
Border	The area or margin that is added to the edge of a wipe or key. Its width and color can be adjusted. The defocusing of the area around a border is referred to as the soft effect.
Chroma key	This refers to the function for creating the key signals based on the color information of the video signals and combining the keys.
Clip	The threshold level of the luminance when key signals are created from a key source.
Color Background	The signals which are output from the internal color generator and used as the background image.
Cut	This refers to the effect where the display is instantly switched to the next image.
Density	A parameter which is used to adjust the density of the key signals.
Dot by Dot	This treats images as actual size (1×) images. With PinP, it allows SD images to be combined with HD images with no accompanying deterioration in the images themselves.
Down Converter	This is the function that converts material in the HD format into the SD format.
DSK [Downstream Key]	This refers to the key combination process which is performed at the end of the mix effect. The key is always combined with the foremost image.
DVE [Digital Video Effect]	This refers to the transition patterns accompanying size reductions or slide effects.
DVI [Digital Visual Interface]	A digital video interface standard. DVI-I can handle both digital signals and analog signals.
Embedded Audio	This refers to the audio data packets which are transferred inside the data stream of the video serial interface.
Flip Flop system (PGM/PST system)	A bus control mode. The signals selected by the program bus are always output as the program images. By executing a transition, the program bus and preset bus signals are switched over.
Flying Key	This function uses DVE effects to move, expand or reduce key signals.

Appendix (glossary)

Word	Explanation
Frame Memory	A memory which can hold the video signals equivalent to one frame.
Frame Synchronizer	A function which matches the synchronization of non-synchronized video input signals.
Freeze	A function which continues the display of the same image, creating the impression that the image has been “frozen”.
FTB [Fade to Black]	This is the effect where the background image is faded out to the black screen.
Genlock	A function for synchronizing the video signals using an external sync signal as the reference.
GPI [General Purpose Interface]	Interface signals which control auto transition from an external source.
Hue	The color tone of the video signals.
IRE	A unit used for video signal levels. The setup level (black level) of the signals is expressed as 0 IRE, 7.5 IRE, etc.
Key Edge	The border or shadow added to the edges of keys.
Key Fill	The signal that uses key combination processing to fill in the areas left blank by the key signals.
Key Gain	A parameter which is used to adjust the amplitude of the key signals.
Key Invert	A function which inverts the key signals.
Key Mask	This is the function that specifies the area for key combination using the box pattern, etc. When only part of the area of the key signals is used, key combination is executed with the unnecessary area masked.
Key Source	The video signals for creating the key signals.
Linear Key	The function which combines keys using monochrome key signals with gradations in its outlines as a reference.
Lum [Luminance]	The brightness portion of the video signals.
Luminance Key	The function which creates key signals based on the luminance (brightness) information of the video signals to combine keys.
ME [Mix Effect]	A video effect device which combines a number of video signals to create mix, wipe, key and other video signals.
Mix	The picture-changing effect produced by overlapping one image with the next. It is also referred to as “dissolve”.
Multi View Display	This function combines multiple materials and displays them on one screen. PGM, PVW and the input material can be previewed at the same time on a single screen.
OSD [On Screen Display]	This function enables settings to be performed on the menu screens which are displayed in the monitor output.
PinP [Picture in Picture]	This function combines a sub screen image with the background image.

Appendix (glossary)

Word	Explanation
PVW [Preview]	The function for checking ahead of time the image which will be output after the next transition. The image is output from the PVW system.
PGM [Program Bus]	The bus which always carries the program output signals.
PST [Preset Bus]	The bus which carries the program output signals after the next background transition.
Preset Memory	The memory in which the control panel statuses can be saved and recalled. The button selection statuses as well as the border, color and other setting information can be saved in this memory.
RS-422	A serial interface standard. It is the interface used to control the switcher from an editor or other external device.
Sat [Saturation]	This refers to the intensity of the color chrominance level of video signals.
SDI [Serial Digital Interface]	The standard by which video signals in various SD and HD formats are transmitted along a single coaxial cable.
Self Key	A function that creates key signals from key fill signals for combining keys.
Tally	The signal which outputs the program output statuses of the input signals to an external device. The LED that indicates the program output status on the control panel is also referred to as tally.
Transition	A function that switches from one image to another. Wipe, mix and other effects are available for the images during switching.
Tri-level Sync	The sync signal used for HD formats.
Trimming	This is the function that eliminates the unnecessary parts at the top, bottom, left and/or right of the images which are combined using the PinP function.
Up Converter	This is the function that converts material in the SD format into the HD format which yields a high resolution.
Wipe	A video effect in which one image is gradually replaced by another as the boundary between the two is moved using a preselected pattern.

Panasonic®

PANASONIC BROADCAST & TELEVISION SYSTEMS COMPANY
UNIT COMPANY OF PANASONIC CORPORATION OF NORTH AMERICA

Headquarters:

3 Panasonic Way 4E-7, Secaucus, NJ 07094 (201) 348-5300

EASTERN ZONE:

3 Panasonic Way 4E-7, Secaucus, NJ 07094 (201) 348-7196

WESTERN ZONE:

3330 Cahuenga Blvd. West, Los Angeles, CA 90068 (323) 438-3608

Government office:

(201) 348-7587

Broadcast PARTS INFORMATION & ORDERING:

9:00 a.m. – 5:00 p.m. (PST) (800) 334-4881/24 Hr. Fax (800) 334-4880

Emergency after hour parts orders (800) 334-4881

TECHNICAL SUPPORT:

Emergency 24 Hour Service (800) 222-0741

Panasonic Canada Inc.

5770 Ambler Drive, Mississauga, Ontario L4W 2T3 (905) 624-5010

Corporativo Panasonic de México

Moras No. 313, Col. Tlacoquemecatl del Valle, Del. Benito Juárez, México, Distrito Federal, C.P. 03200. 01 (55) 54 88 10 00

Panasonic Puerto Rico, Inc.

AVE 65de Inf, Km 9.5 Carolina, PR 00985 (787) 750-4300