

ONKYO®

Intelligent Remote Controller

USR-5RF

**Instruction
Manual**

Thank you for purchasing the Onkyo Intelligent Remote Controller. Please read this manual thoroughly before making connections and plugging in the unit. Following the instructions in this manual will enable you to obtain optimum performance and listening enjoyment from your new Intelligent Remote Controller. Please retain this manual for future reference.

Contents

Quick Start 4

Before Using 7

Operations 11

Other Information 39

Precautions

Care

From time to time you should wipe the front and rear panels and the cabinet with a soft cloth. For heavier dirt, dampen a soft cloth in a weak solution of mild detergent and water, wring it out dry, and wipe off the dirt. Following this, dry immediately with a clean cloth. Do not use rough material, thinners, alcohol or other chemical solvents or cloths since these could damage the finish or remove the panel lettering.

FCC Information for User

CAUTION:

The user changes or modifications not expressly approved by the party responsible for compliance could void the user's authority to operate the equipment.

NOTE:

This equipment has been tested and found to comply with the limits for a Class B digital device, pursuant to Part 15 of the FCC Rules. These limits are designed to provide reasonable protection against harmful interference in a residential installation. This equipment generates, uses and can radiate radio frequency energy and, if not installed and used in accordance with the instructions, may cause harmful interference to radio communications. However, there is no guarantee that interference will not occur in a particular installation. If this equipment does cause harmful interference to radio or television reception, which can be determined by turning the equipment off and on, the user is encouraged to try to correct the interference by one or more of the following measures:

- Reorient or relocate the receiving antenna.
- Increase the separation between the equipment and receiver.
- Connect the equipment into an outlet on a circuit different from that to which the receiver is connected.
- Consult the dealer or an experienced radio/TV technician for help.

NOTE:

If serial or parallel ports are configured, a filtered/shielded serial or parallel cable is recommended to minimize EMI and ensure FCC B compliance.

This device complies with Part 15 of the FCC rules. Operation is subject to the following two conditions:

2

(1) This device may not cause harmful interference, and (2) this device must accept any interference received, including interference that may cause undesired operation.

Changes or modifications not expressly approved by the party responsible for compliance void the user's authority to operate the equipment.

For Canadian models

NOTE: THIS CLASS B DIGITAL APPARATUS COMPLIES WITH CANADIAN ICES-003.

For models having a power cord with a polarized plug:

Modèle pour les Canadien

REMARQUE: CET APPAREIL NUMÉRIQUE DE LA CLASSE B EST CONFORME À LA NORME NMB-003 DU CANADA.

Table of contents

Quick Start	4
Quick Reference	5
Introduction	7
1. Intelligent remote controller	7
2. Charging the remote controller	9
Getting Started	11
1. Activat the remote controller	11
2. Define the Brands of Your Devices	11
3. Select a Device	16
4. Operate a Device	17
5. Adjust the Settings	19
Getting the Maximum out of it	21
1. Introduction	21
2. Program Buttons	23
3. Label Buttons and Menu Items	25
4. Add and Move Devices	27
5. Delete and restore	28
6. Record Macros and Set Time	30
7. Using the remote controller with Radio Frequency	33
8. ChadEdit	37
Troubleshooting	39
1. General Problems	39
2. Programming Problems	39
3. Recharging Problems	40
FAQ	41
Overview of Symbols	42
Specifications	43

Quick Start

Insert batteries

Insert 4 AA batteries according to the picture on the inside of the battery compartment.

or

Use a rechargeable battery pack (sold separately). (Remove the AA battery tray first). Before using the remote controller, be sure to charge the battery completely according to the instructions in the manual.

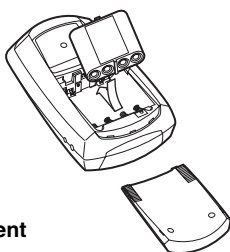

Battery compartment cover slides off

Touch the screen to start

To turn on the screen, tap it gently with your finger.

To use the touchscreen, simply tap the images you see on the screen.

There's no need to turn the screen off — it shuts off automatically to save power.



Be sure to read the manual for important information about care and use of the touchscreen.

Operate your components

Fresh out of the box, the remote controller is already set up to work with popular components made by Onkyo. Programming the remote controller is easy: Add components to the Device menu as necessary. Then, program the commands to the remote controller for the components. For instructions, refer to the manual.

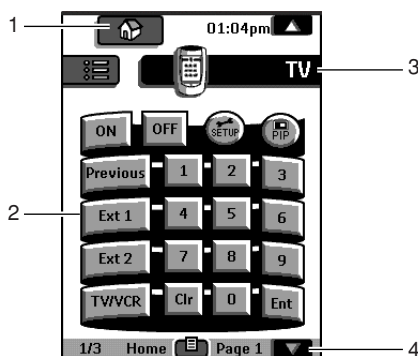

1. Home

If you get lost, you can always go Home menu screen. Just tap Home.

2. Tap name of component to display component's control panels.

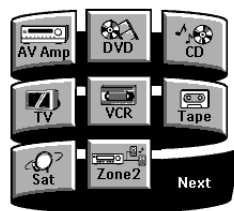

3. You can also use the Device menu; tap to display it.

4. Tap to scroll to next panel for this component.

Quick reference

Quick reference

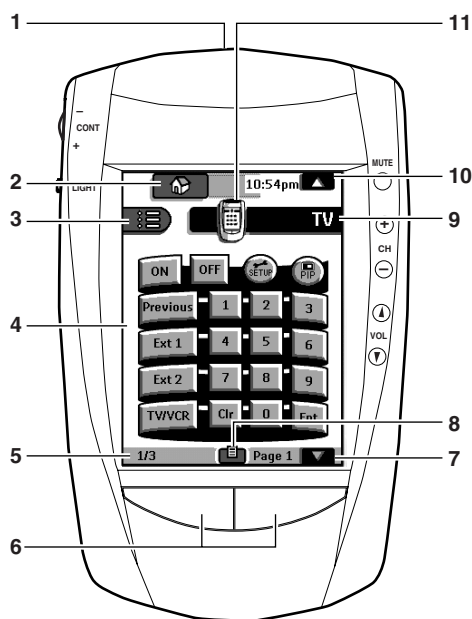

1. Sending eye (IR transmitter)/Learning eye

Send commands to devices
For learning commands from other remote controllers

2. Home

Easy access to all components

3. Macro menu

Execute stored lists of commands



4. Control panel

Tap buttons to send commands to components

5. Panel number

Shows what panel you're seeing.

6. Left and Right buttons

Activate the commands shown immediately above the buttons

7. Scroll button

Display next Control Panel. Scroll buttons may appear on left.

8. Mode menu

Customize the remote controller (see below)



9. Device menu

Open a component's control panels

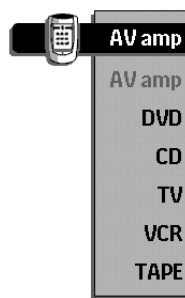

10. Scroll button

Display previous control panel

11. Remote controller icon

Press and hold for 3 seconds to go to Setup

Quick reference

Modes

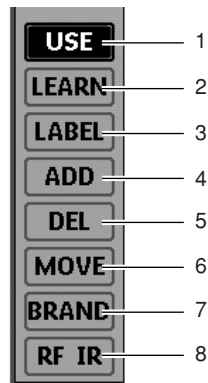

- 1. Normal use controlling components.**
- 2. Learn commands from other remote controllers.**

When a macro panel is displayed, this button changes to REC for recording macros.
- 3. Assign letters and symbols to buttons and commands.**
- 4. Add a new component or group of macros.**
- 5. Delete a button, component, macro, or macro group.**
- 6. Change the order of commands in a menu.**
- 7. Define the brands of your device.**
- 8. Configure the remote controller to operate devices with RF or IR signals.**

Introduction

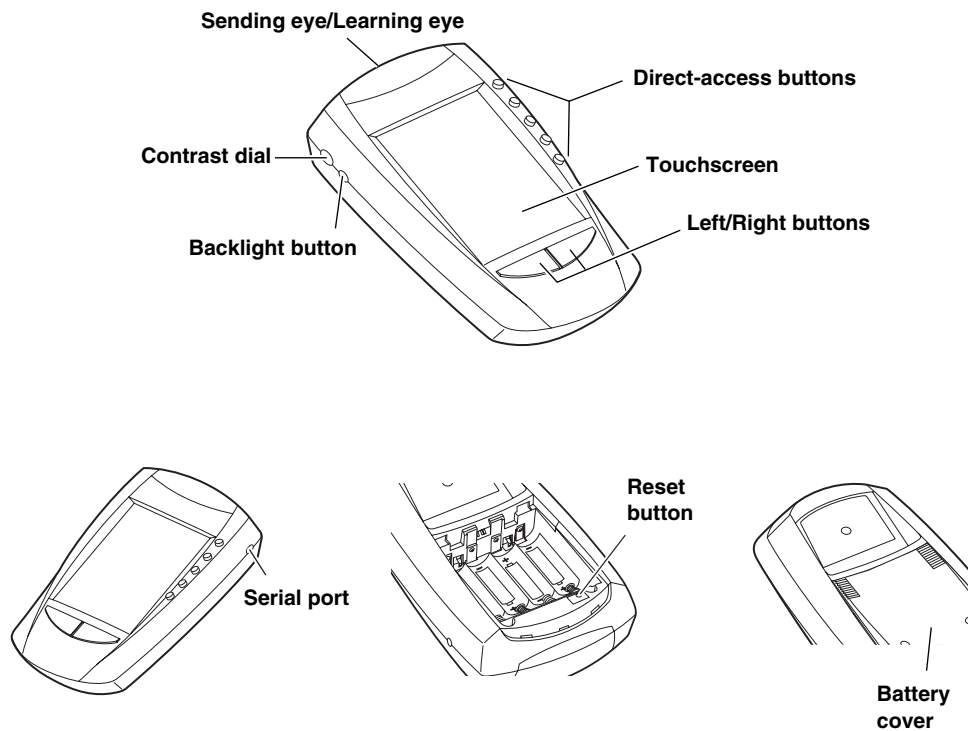

1. Intelligent Remote Controller

The intelligent remote controller can be used for all devices that understand infrared remote controller signals. It's easy-to-use touchscreen and its intuitive interface makes it a perfect remote controller for every user.

The remote controller is completely customizable and programmable. You can add devices and functions, relabel buttons, record macros and set timers. To make the remote controller your universal remote controller, it is designed to learn from existing remote controllers.

Direct-access buttons

The buttons labeled MUTE, CH, and VOL are direct-access buttons. The direct-access buttons make these frequently used functions available even when the touchscreen is off. You can program them so that they always operate the same components — for example, the TV. or, you can program them to operate different devices at different times.

Introduction

Left and Right buttons

The Left and Right buttons change function depending on the device the remote controller is controlling. Labels displayed above them on the touchscreen show their current function.

Touchscreen buttons

Buttons on the touchscreen let you control particular devices. You activate the buttons by tapping them with your finger.

Which Buttons Can Be Programmed?

Direct-access buttons, Left and Right buttons, and buttons on the touchscreen can all be programmed. You can set the direct-access and Left/Right buttons to always perform the same function. Or, you can program them to perform different functions depending on the device. For instructions, see "Programming Buttons" on page 23.

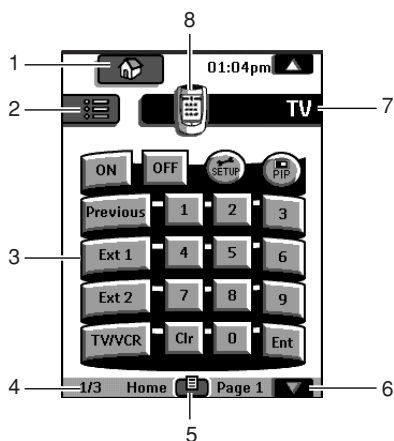

1. Home: to go to the Home menu

2. Macro menu: to open stored list of commands

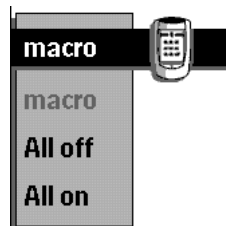

3. Control panel: to send commands to components

4. Panel number: shows active control panel

5. Mode menu: to customize the remote controller



6. Scroll buttons: to display previous and next control panel

7. Device menu: to open device control panels

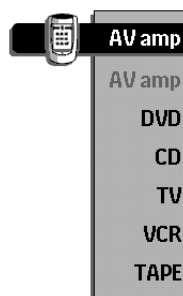

8. Remote controller icon: Touch and hold to enter Setup

Introduction

2. Charging the Remote Controller

AA batteries

1. Slide the battery cover off the back of the remote controller.

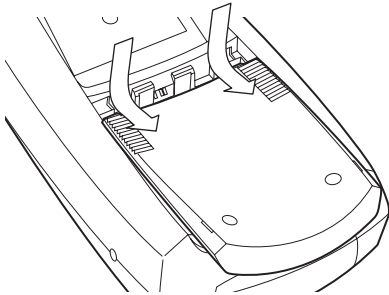

2. Insert 4 AA batteries (included in package) as indicated on the bottom of the battery compartment.

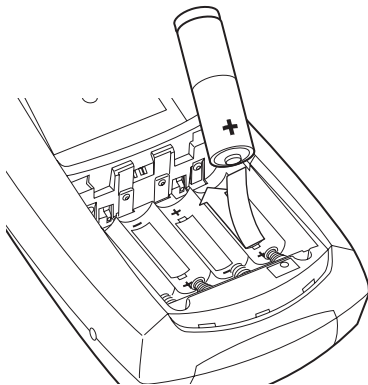

3. Slide the battery cover back on.

After a few seconds, the remote controller starts up automatically and beeps twice to indicate that it is ready to use.

When batteries are running low, the Low Battery icon  blinks at the center top of the display. Replace the batteries as soon as possible to ensure perfect performance.

Note:

The remote controller retains all settings when batteries have run out or when you replace them. You will only have to reset the clock.

Introduction

Optional recharging dock

Warning:

Use the recharging dock only with the NiMH rechargeable battery pack of BCC-5.

1. Slide the battery cover off the back of the remote controller.
2. Remove the plastic AA battery tray from the battery compartment.

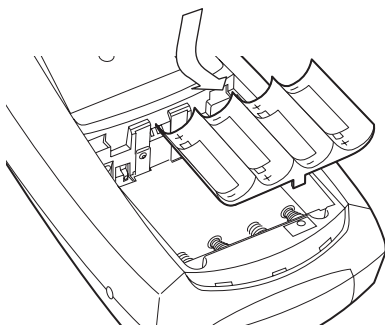

3. Insert the battery pack (included with the recharging dock) as indicated on the side of the battery pack.

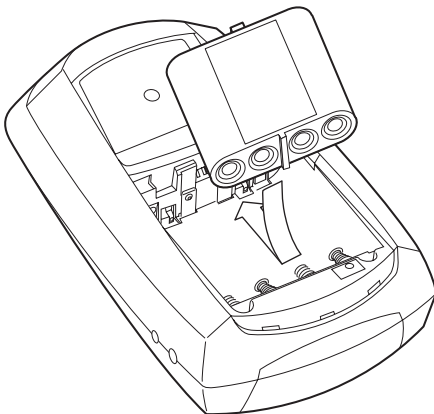

4. Slide the battery cover back on.

After a few seconds, the remote controller starts up automatically and beeps twice to indicate that it has finished starting up.

5. Plug the power adapter into a wall outlet and connect it to the recharging dock.

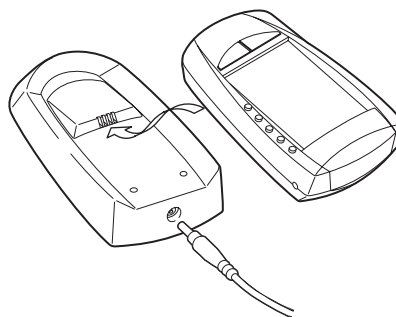

6. Place the remote controller on the recharging dock.

Recharging starts automatically. The light on the front of the recharging dock indicates charging takes place. When the battery pack is fully charged, the light goes off.

Notes:

- You can operate the remote controller while it is being charged.
- Normal charging time is 2 to 3 hours, depending on the condition of the battery pack.

When the battery pack is running low, the Low Battery icon  blinks at the center top of the display. Recharge the batteries as soon as possible to ensure perfect performance.

Note:

The remote controller retains all settings when the battery pack has run out. You will only have to reset the clock.

Getting Started

1. Activate the remote controller

Turning on the display

- Tap the screen gently with your finger or a blunt, soft object like a pencil eraser.

The display is activated and you see the Home panel.

Notes:

- If the display stays blank or becomes black, adjust the contrast dial on the left side.
- If another panel is displayed, tap the Home button.
- The remote controller shuts down automatically.

Using the backlight

- Press the backlight button on the left side.



The backlight shuts off automatically after a few seconds to save power.

Note:

In the settings (page 19) you can choose to activate the backlight automatically when you activate the remote controller.

Use mode

The remote controller has different “modes.” When you activate the remote controller for the first time, it starts up in Use mode allowing you to immediately operate your devices.

In Use mode, the remote controller icon  is entirely visible. If a label (like ) covers the icon, see page 22 to switch your remote controller to Use mode.

2. Define the Brand of Your Device

The remote controller uses RC codes to activate device. Since there are several brands using specific RC codes, you have to define the brands of your devices.

In the Home menu, you find buttons for the most common video and audio devices. The remote controller is set up by default to operate with Onkyo devices.

1. Select a device in the Home menu.

The following screen appears.

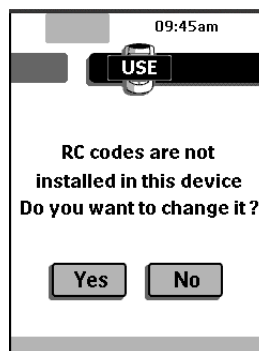

When selecting CD, DVD, MD or CDR

When you select CD, DVD, MD or CDR, the preset RC codes for operating Onkyo's CD player, DVD player, MD recorder or CD recorder are used, and the operation buttons for the device appear on the screen. You can use the preset RC codes only when the Onkyo's device you selected and Onkyo's amplifier or receiver are connected using **RI** interface.

Getting Started

When you operate Onkyo's CD player, DVD player, MD recorder or CD recorder which has no **RI connectors or is not connected using **RI** interface, you need to define the brand of your device.**

1. In the Mode menu, select Brand.
2. Select the device you want to define.
3. Select Next.

The brand selection screen appears.

4. If you selected CD player, DVD player or CD recorder, select Onkyo or Onkyo-x other than Onkyo-1 from the brand list. If you selected MD player, select Onkyo-5.

To reset the RC codes settings back to the one for the device using **RI connection, follow these steps.**

1. In the Mode menu, select Brand.
2. Select the device you want to reset the RC codes settings for.
3. Select Next.

The brand selection screen appears.

4. If you selected CD player, DVD player or CD recorder, select Onkyo-1 from the brand list. If you selected MD player, select Onkyo-4.

2. Select "Yes" to define the brand of the device to operate.

The remote controller switches to Brand mode. Follow the instructions as described below. You can define your brands by selecting or by searching.

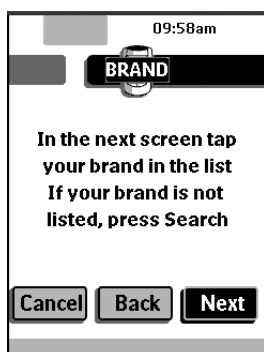

Note:

Before you start using the remote controller, make sure you define the brand for each device you want to operate in the Home Menu.

Defining brands by selecting

A list of brands and their corresponding RC codes are pre-installed in the remote controller's memory.

You need to select your brand from the list and because not every device of a certain brand uses the same RC codes, you might also have to select a set of RC codes for your brand.

3. Tap Next.

A scrollable list of brands for the selected device and a "virtual auto-zooming" mini-keyboard appears.



Getting Started

4. Navigate through the list of brands.

Use the scroll buttons to scroll up or down in the list of brands.

- By tapping the scroll buttons, you scroll through the brands one by one. By touching and holding the scroll buttons, the scrolling speed will increase.
- Use the mini-keyboard to jump through the list of brands.

To enter a character, tap the keyboard near the character you want to use. The keyboard is zoomed in, allowing you to tap exactly the character you need.

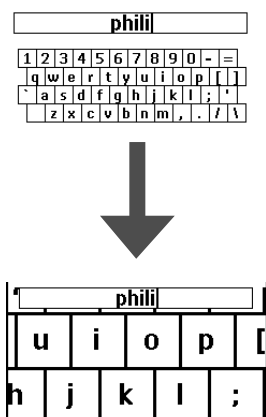

To enter a space, tap the lower left corner of the keyboard. When the keyboard is zoomed in, tap the empty key.

After you have typed the character, the keyboard is zoomed out. Repeat this action for every character.

Every time you enter a character, the list displays the brands that match the character(s). The remote controller makes a pre-selection of the (first) brand that matches. You only have to type as many characters as needed to display your brand.

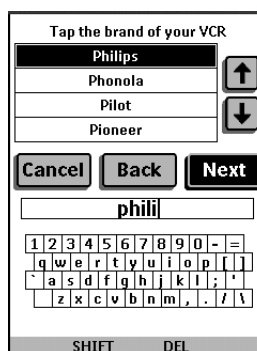

Note:

In case, your brand is not displayed in the list of brands, Try Search mode. See "Defining brands by searching" on page 15.

5. Select your brand from the list.

The selected brand will be highlighted. The Search button switches into Next.

Getting Started

6. Tap Next.

When your brand uses only one set of RC codes, the remote controller switches to Try mode. Go to step 9.

When there are several code sets for your brand, the following screen appears.

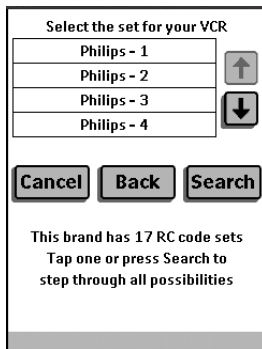

Notes:

- The code sets are ranked. The first code set in the list is used for most devices of the selected brand.
- When you do not know which code set to select from the list, you can use Search mode. See “Defining brands by searching” on page 15.

7. Select a code set from the list.

The selected code set will be highlighted. The Search button switches to Next.

8. Tap Next.

The remote controller switches to Try mode. The first control panel of the selected device is displayed.

9. Try the buttons on the different control panels and check if the device is responding to the RC codes the remote controller is sending.

Note:

However, your device is responding to the current code set, it is recommended to try other code sets. When your device responds to more than one code set, install the most suitable one.

10. If you are not satisfied with the way the device is responding to the selected code set, tap Back to select another code set.

or

When you are satisfied with the selected code set, tap Install.

When the RC codes for your devices are installed, the remote controller beeps and returns to Use mode. Your brand is now defined for the selected device.

11. Define all other devices in the Home menu you want to operate.

Getting Started

Defining brands by searching

You can use Search mode to find the matching RC codes for your device when

- your brand is not displayed in the list of brands,
- you selected your brand, but you do not know which code set to select.

3. Tap Next.

The display shows a scrollable list of brands for the selected device and a “virtual auto-zooming” mini-keyboard.

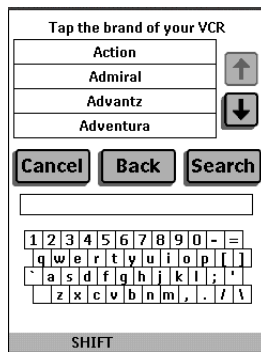

4. Tap Search

The remote controller automatically searches through all available brands and code sets to find the RC codes matches.

5. Tap Next to start sending appropriate commands for the selected device.

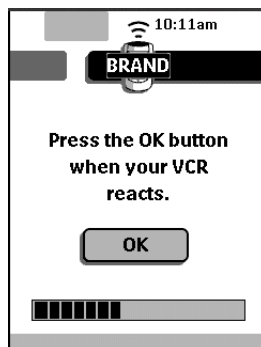

6. Tap OK when the device reacts.

Notes:

- Even when the device is responding to the current code set, it is advised to try other code sets. When your device responds to more than one code set, install the most suitable one.
- The name of the responding code set is displayed when you tap the OK button, so you know which code set to select from the list after you have tried other code sets

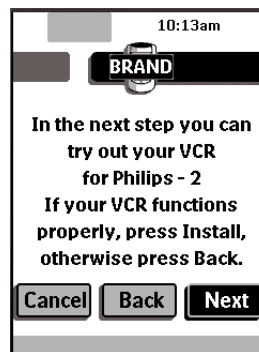

The remote controller switches to Try mode. The first control panel of selected device is displayed.

7. Try the buttons on the different control panels and check if the device is responding to the RC codes the remote controller is sending.

8. When you are not satisfied with the current function of the device, tap Back to continue the automatic search.

or

When you are satisfied with the selected code set, tap Install.

When the RC codes for your devices are installed, the Remote Control beeps and returns to Use mode. Your brand is now defined for the selected device.

9. Define all other devices in the Home menu you want to operate.

Getting Started

3. Select a Device

Via the Home menu

In the Home menu, you find buttons for the most common video and audio devices. These buttons are preprogrammed to work with popular devices made by Onkyo. If you have devices of other manufacturers that do not respond to your remote controller, you can program your remote controller using your original remote controllers (see “Programming Buttons” on page 23).

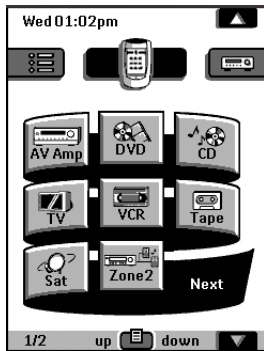

■ Tap the device you want to operate.

The first control panel of the selected device appears.

Via the Device menu

The Device menu allows you to easily switch to another device without returning to the Home menu.

1. From within any device control panel, tap the device tab.

The Device menu pops up. You can scroll through this menu using ▲ and ▼.

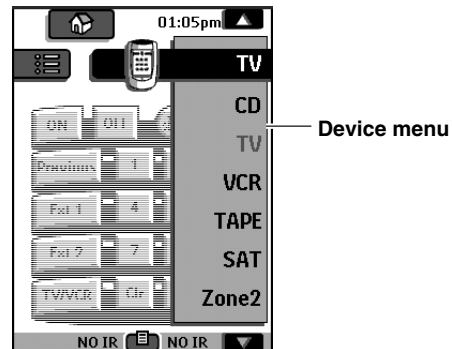

2 In the Device menu, tap the device you want to operate.

The control panel that was last accessed for the device appears.

Note:

You can also activate the Device menu from Home by tapping the device tab icon .

Getting Started

4. Operate a Device

You operate devices using three kinds of buttons:

- **Touchscreen buttons**
- **Left and Right button (below the touchscreen)**
- **Direct-access buttons (to the right of the touchscreen)**

Using touchscreen buttons



Sending commands

By touching the touchscreen buttons you send commands to the device you have selected. When you send a command, the remote controller icon

shows transmitting signals . The name of the active device is indicated on the device tab.



Scrolling

Most devices have more than one control panel. You can scroll through these control panels using  and . The panel number on the left bottom of the screen indicates the panel number and the total number of panels, for example **1/3**.

By touching and holding a scroll button, you go repeatedly through all the control panels of a device in a loop.

Operating a device without affecting the active device

You can operate a device while another device is active (for example, rewinding your VCR while watching TV) via the Device menu:

1. **Open the device menu.**
2. **Press and hold the Left or Right button (labeled NO IR).**

The remote controller icon turns around .

3. **Tap the device you want to operate.**

The device control panel appears and the remote controller icon turns to its original position. You can now operate the new selected device without affecting the active device.

Getting Started

Using the Left and Right button

The Left and Right buttons change function depending on the device the remote controller is operating. The current function is displayed on the touchscreen right above the button. The function can be either an IR (infrared) command that is transmitted, or a jump to a specific device page.

IR commands



Device pages



Getting Started

5. Adjust the Settings

Most of the remote controller's features can be set to your own needs.

1. Touch and hold the remote controller icon for a few seconds.

The first setup panel appears. You can see the second and third setup panel by using the scroll buttons.

2. Tap the button of the setting you want to adjust.

The button becomes black.

3. Use the Left and Right button to adjust the setting.

Note:

Tap the Left and Right buttons are repeating buttons; holding down one of these buttons will increase or decrease a value repeatedly.

First setup panel

Setting	Function	Adjusting
Battery	Shows the battery level.	
Clock	Turns the clock display on or off and lets you set 12 or 24h time display.	Tap the clock repeatedly.
Time	Sets the clock.	Tap the time button and use the Left and Right button.
Day	Sets the day.	Tap the day button and use the Left and Right button.
LCD	Sets how long the touchscreen stays on.	Tap the LCD button and use the Left and Right button.
LCD Light	Sets how long the backlight of the touchscreen stays on.	Tap the LCD Light button and use the Left and Right button.
Button Light	Sets how long the backlight of the direct-access and Left/Right buttons stays on.	Tap the Button Light button and use the Left and Right button.

Getting Started

Second setup panel

Setting	Function	Adjusting
Level	Turns the backlight always on or off when activating the touchscreen. Note: When you choose always off, you can only activate the backlight using the backlight button.	Always on: Tap the Level button and position the indicator in the left half of the indication bar using the Left button. Always off: Tap the Level button and position the indicator in the right half of the indication bar using the Right button.
Mode Menu	Hides or shows the Mode button. Hiding the Mode button prevents unwanted changes to stored commands.	Tap the Mode Menu button.
Touch	Adjusts or turns off the touchscreen beep.	Tap the Touch button repeatedly.
Button	Adjusts or turns off the beep of Left/Right and direct-access buttons.	Tap Button repeatedly.
Calibrate	Calibrates the touchscreen.	Tap the Calibrate button and follow the on-screen instructions.
Revert	Reverts the remote controller to the factory default configuration.	Tap the Revert button and follow the on-screen instructions.

Third setup panel

This panel provides technical information about your remote controller.

To exit Setup Mode

- Tap the Setup label on the remote controller icon.

Getting the Maximum out of it

1. Introduction

The remote controller is preprogrammed to work with all equipment that recognizes NEC infrared codes. This includes all Onkyo devices and several devices made by other manufacturers.

What makes the remote controller so powerful is the ability to extend its functionality in multiple ways like programming additional functions, adding supplementary devices, recording macros and customizing the interface as it suits you best.

Working with Modes

When you operate your devices, the remote controller is in Use mode. For actions other than operating (like programming buttons, recording macro's, adding devices, and so on) you have to switch to the appropriate mode:

USE : To operate devices.

LEARN : To input commands from other devices.
For recording macros and setting timers.

LABEL : To label buttons and commands.

ADD : To add new devices.

DEL : To delete buttons, devices and macros.

DEL : To change the listing order in a menu.

BRAND : To define brands using the remote controller's database.

RF IR : To configure the remote controller to operate devices with RF or IR signals.

Getting the Maximum out of it

To switch to another mode

1. Tap the Mode button at the bottom of the touchscreen.

The Mode menu pops up.

2. Tap the mode you want to use.

The label of the active mode appears on the remote controller icon. You can now work in the selected mode.

Note:

When a label is displayed, you can also display the Mode menu by tapping the label.

To hide the Mode menu

To prevent accidental changes to the remote controller interface and commands, you can hide the Mode menu:

1. Make sure the remote controller is in Use mode.

2. Touch and hold the remote controller icon for a few seconds.

The first setup panel appears.

3. Scroll down to the second setup panel.

4. Tap the Mode Menu button.

The mode menu icon is crossed out.

5. Tap **SETUP.**

The remote controller switches to Use mode. The Mode button is no longer visible.

Getting the Maximum out of it

2. Programming Buttons

You program the remote controller commands by transmitting infrared signals from your existing remote controls to the remote controller's learning eye. To do this, place the remote controller and the device's remote controller on a flat surface, 15 to 20 cm (6 to 8 inches) apart.

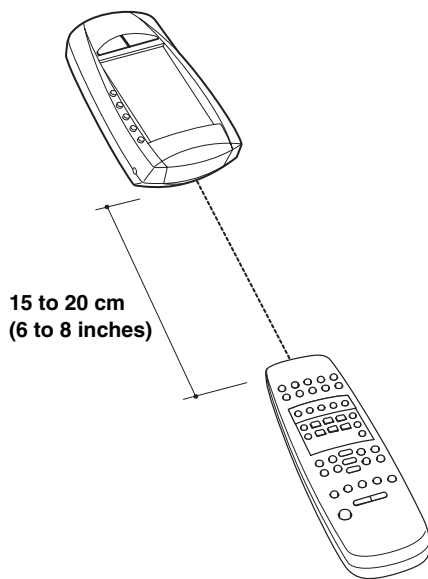

The following buttons can be programmed: control panel buttons, Device menu items, direct-access buttons and Left/Right buttons.

You cannot program Home menu buttons directly. You need to program them by following the Device menu (see page 24).

The remote controller also offers empty control panel buttons you can program and label as existing buttons. They are only visible in Learn and Label mode and appear without label or with label (intended for a specific function). You will also see previously deleted buttons: you can restore them by reprogramming them or you can reuse them for other commands.

Programming control panel buttons

1. Navigate to the control panel buttons you want to program.

2. Switch to Learn mode by using the Mode button.

Additional empty buttons appear: they can be programmed and labeled as existing buttons.

3. Point the device's original remote controller to the remote controller's learning eye as shown (see above).

4. Tap the remote controller button you want to program.

The button starts blinking.

5. Press and hold the corresponding button on your device's original remote controller.

If the remote controller has learned the command successfully, OK blinks on the remote controller icon. You can let go of the button you're holding.

If the remote controller has not learned the command successfully, you hear a short buzz and FAIL appears on the remote controller icon.

6. Program all other buttons you want and relabel them as necessary (see page 25).

7. Return to Use mode by using the Mode button.

Getting the Maximum out of it

Programming device items

Note:

When you program a command to a device item, this command is automatically assigned to the corresponding button in the Home menu.

1. Make sure the device tab is active.

The device tab is active when the name of a device is displayed.

2. Switch to Learn mode by using the Mode button.

3. Point the device's original remote controller to the remote controller's learning eye as described above.

4. Tap the device tab to open the Device menu.

5. Touch and hold either the remote controller's Left or Right button and tap the device you want to program.

Even when you want to program the currently active device, you have to tap it in the Device menu.

The label device starts blinking on the remote controller icon.

6. Press and hold the button the remote controller has to learn on your device's original remote controller.

If the remote controller has been input the command successfully, OK will blink on the display. You can release the button you're holding.

If the remote controller has not learned the command successfully, you hear a short buzz and FAIL appears on the remote controller icon.

7. Program all other items you want and return to Use mode via the Mode button.

Programming direct-access and Left/Right Buttons

Direct-access and Left/Right buttons can be programmed with a global function or with functions per device. Buttons with global functions always execute the same command, even if device is active. Buttons with functions per device execute commands depending on the active device. For example, the Left button is the Play command when the VCR is active.

Note:

Per-device functions overrule global functions. For example, when you program the Volume buttons globally but you assign a specific function to them with the tuner, the specific command will be executed when the tuner is the active device.

Programming a button globally

1. Tap the Home menu button .
2. Complete steps 2 to 7 in "Programming control panel buttons" on page 23. Instead of tapping a button on the touchscreen, press the button you want to program.

The label of the button you have pressed (e.g. chan+ or left) starts blinking on the remote controller icon.

Programming a button per device

1. Switch to the device for which you want to program the button.
2. Complete instructions 2 to 7 in "Programming control panel buttons" on page 23. Instead of tapping a button on the touchscreen, press the button you want to program.

The label of the button you have pressed (e.g. chan+ or left) starts blinking on the remote controller icon.

Getting the Maximum out of it

3. Labeling Buttons and Menu Items

The following elements can be labeled: control panel buttons, Device menu items, macros, macro groups and Left/Right buttons.

You cannot label Home menu buttons directly. You have to label them by using the Device menu (see page 26).

Labeling a button

1. Navigate to the panel containing the button you want to label.
2. Switch to Label mode by using the Mode button .
3. Tap the button you want to label.

The display shows a “virtual auto-zooming” mini-keyboard. The button you want to label is displayed above the keyboard.

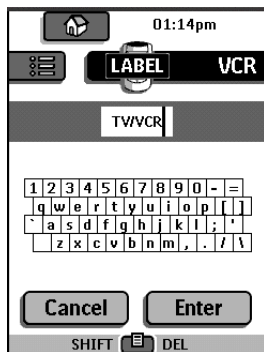

4. Edit the label.

- To delete a character, press the Right button.
- To enter a character, tap the keyboard near the character you want to use. The keyboard is zoomed in, allowing you to tap exactly the character you need.

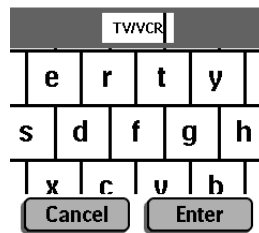
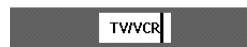

After you have tapped the character, the keyboard is zoomed out. Repeat this action for every character.

Note:

You can zoom out again without tapping a character by pressing the Right button (labeled Zoom).

- For capital letters and symbols, press the Left button repeatedly to display the keyboard you want.

Getting the Maximum out of it

5. Tap **Enter** to save the changes and return to the panel you were. -or- Tap **Cancel** to return to the panel you were without saving changes.
6. Label all other items you want and return to **Use mode** via the **Mode** button.

Labeling a menu item

1. Switch to **Label mode** by using the **Mode** button.
2. Tap the device tab to open the **Device** menu.
3. **Touch and hold either the remote controller's Left or Right button and tap the device you want to program.**
Even when you want to program the currently active device, you have to tap it in the **Device** menu.
4. Complete instruction 4 to 6 in "**Labeling a button**" on page 25.

Getting the Maximum out of it

4. Adding and Moving Devices

Adding devices

If you have a device that is not provided in the Device menu, you can add it to the remote controller.

You cannot add devices to the Home menu directly. You have to add them by using the Device menu.

1. Make sure the device tab is active.

The device tab is active when the name of a device is displayed.

2. Switch to add mode by using the Mode button.

The remote controller displays the following choices:

- Add New Device: Choose this option to add a completely new device.
- Copy Existing Device: Choose this option to copy a device already provided in the Device menu (for example for a second television).
- Restore Deleted Device: Use this option to restore a device you have deleted.

3. Tap the device you want to add in the Device menu.

Note:

If the device you want to add is not provided, choose a similar one. You can customize it later.

The remote controller gives you the possibility to add the device with or without RC-codes.

- Add by RC-codes: Choose this option if you think the new device understands RC-codes. The new device is added with operational buttons.

- Don't add RC codes: If you choose this option, the new device is added without operational buttons. You can program them as described in "Programming control panel buttons" on page 23.

4. Tap the button of your choice.

The new device is automatically displayed in Use mode.

Moving menu items

You can change the order of Device menu items and Macro menu items. Changes you make in the Device menu are automatically updated in the Home menu.

1. Make sure the device tab is active. or Make sure the macro tab is active.

The device or macro tab is active when the name of a device or macro is displayed.

2. Switch to Move mode by using the Mode button.

The remote controller displays the menu.

3. Tap the menu item of your choice.

The menu item is highlighted.

4. Use the Left and Right button to move the menu item up or down.

5. Tap Accept to save the changes.

You return to Use mode.

Getting the Maximum out of it

5. Delete and restore

Delete

You can delete control panel buttons and functions associated with a direct-access or a Left/Right button.

You can also delete Device menu items and Macro menu items.

Home menu buttons cannot be deleted directly. You have to delete them via the Device menu.

Deleting a button or button function

Note:

Buttons without bold frame can not be deleted. You can only hide them by removing their label (see “Labeling a button” on page 25).

START

1. Switch to Delete mode by using the Mode button.

2. Tap the button you want to delete.

3. Tap Delete Button Action.

The result depends on the element you are deleting:

- Control panel button: The button disappears from the display.
- Left or Right button command: The corresponding label disappears from the display.
- Direct-access button: The button becomes inactive.

4. Delete all the items you want and return to Use mode via the Mode button.

Deleting a device or macro menu item

1. Switch to Delete mode via the Mode button.

2. Navigate to the menu item you want to delete.

When Device menu is opening, The function of Left and Right button changes as shown below.

Left button: Label

Right button: Action

When Macro menu is opening, The function of Left and Right buttons will be Group.

3. Press and hold down the Left or Right button depending on what you are deleting:

- Left button labeled Device: For deleting a device in the Device menu.
- Right button labeled Action: For deleting an action from an item in the Device menu.
- Left button labeled Group: For deleting a macro group.

4. Tap the menu item you want to delete.

5. Tap Delete Device or Delete Macro Group.

The Device (and its associated Home menu button) or the Macro Group (including its macros) are deleted.

6. Delete all the items you want and return to Use mode via the Mode button.

Getting the Maximum out of it

Restore

After you deleted a control panel button or a menu item, the button or item is no longer visible in Use mode but remains in the remote controller's memory. This allows you to restore it in Edit mode.

Actions associated with direct-access or a Left/Right buttons cannot be restored. You have to reprogram them as explained in "Programming Direct-access and Left/Right Buttons" on page 24.

Control panel buttons

- 1. Switch to Edit mode by using the Mode button.**
The deleted buttons become visible.
- 2. Complete instruction 3 to 7 in "Programming control panel buttons" on page 23.**
The button is restored.

Device or Macro menu items

- 1. Make sure the device tab or macro tab is active.**
The device or macro tab is active while the name of a device or macro is displayed.
- 2. Switch to Add mode by using the Mode button.**
- 3. Tap Restore Deleted Device or Restore Deleted Group.**
The deleted menu items become visible.
- 4. Tap the item you want to restore.**
The item is restored and you return to Use mode.

Note:

Only the macro group itself is restored, not the macros it contained.

Getting the Maximum out of it

6. Recording Macros and Setting Timers

A macro enables you to send a sequence of IR commands using one single button.

By setting a time, you can activate a device at the time you prefer. See page 31.

Note:

To record a macro or to set a timer, there must be at least one macro group or timer group in the Macro menu. To create these groups, see page 32.

Recording macros

1. Tap the Macro menu button.
2. Open the macro menu and select a macro group.



3. Switch to Edit mode via the Mode button.

Empty the macro buttons appear in the macro control panel.

4. Tap the button you want to use for your macro.

5. Enter the sequence of commands you want to record.

You can navigate to any control panel you want, just as you can in Use mode.

6. Tap the Macro menu button.

The contents of the macro appear. You can now play, edit, or close the macro.

7. Press the Left button to close the macro.

A confirmation screen appears where you can save or cancel the macro.

8. Tap Save and assign a label to the macro.

The macro is ready to be used.

There are two extra commands you can record in a macro:

Source switching

To record a Device menu item containing a source switching command, open the Device menu, hold down the Right button (labeled Action) and tap the device you want to switch to.

Close a device control panel

To close a macro display of device, open the Device menu, hold down the Left button (labeled Device) and tap the device you want.

Getting the Maximum out of it

Editing macros

You can edit any macro you have recorded.

1. **Open the macro group that contains the macro.**
2. **Switch to Edit mode via the Mode button.**
3. **Tap the macro you want to edit.**

The contents of the macro appear.

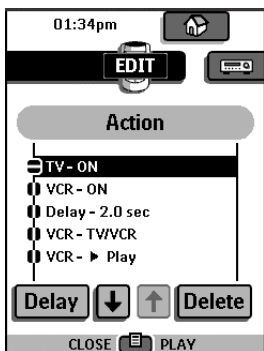

4. **Edit the macro.**

You can move or delete listed commands or you can add new commands. You can also add delays to the macro (for example, to insert a short pause between turning on a device and sending commands to it allowing the device to warm up):

1. Tap Delay.
2. Tap \oplus or \ominus to decrease or increase the length of the delay.
3. Use the arrow buttons \uparrow and \downarrow to move the delay to the right place.

5. **Press the Left button to close the macro.**

A confirmation screen appears, which allows you to save or cancel the macro.

6. **Tap Save.**

The macro is ready to be used.

Setting timers

To activate a device at the time you set.

1. **Tap the Macro menu button.**
2. **Open the macro menu and select a timer group.**
3. **Switch to Edit mode by using the Mode button.**

Empty timer buttons appear in the timer control panel.

4. **Tap the button you want to set a timer for.**

The first timer control panel appears in which you can set the start time.

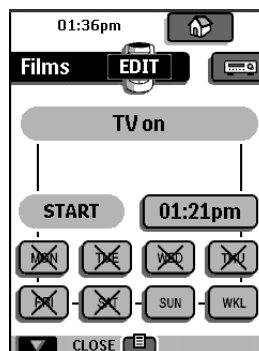

5. **Enter the command the timer has to execute.**

A timer can contain either a single IR command or a macro.

You can navigate to any control panel you want, just as you can in Use mode.

Getting the Maximum out of it

6. Tap the clock button and set the start time using the Left/Right buttons.

7. Tap one or more day buttons to select or deselect days for the timer.

You can choose to repeat the timer weekly.

8. Scroll down to display the second timer control panel in which you can set the stop time.

9. Enter the command the timer has to execute.

10. Tap the clock button and set the stop time using the Left/Right buttons.

11. Press the Left button to close the timer.

A confirmation screen appears, which allows you to save or cancel the timer.

12. Tap Save.

The timer is activated.

Note:

The timer only works when the remote controller's sending eye is pointed towards the controlled device and no obstructions interfere the infrared signal.

Editing timers

You can edit any timer you have set.

1. Open the timer group that contains the timer.

2. Switch to Edit mode via the Mode button.

3. Tap the timer you want to edit.

The contents of the timer appear.

4. Edit the timer.

5. Press the Left button to close the timer.

A confirmation screen appears, which allows you to save or cancel the timer.

6. Tap Save.

The timer is edited.

Organizing macros and timers into groups

You can create as macro groups or timer groups up to 25 macros or timers in each group.

1. Open any macro or timer group.

2. Switch to Add mode by using the Mode button.

You can create a new group, copy an existing group, or restore a previous deleted group.

- **Create a new group:** You add a new group in which you can record new macros.
- **Copy an existing group:** You copy a group and its macros and use it for new macros.
- **Restore a previously deleted group:** You restore a deleted group and reuse the macros.

3. Tap Create Timer Group or Create Macro Group.

Getting the Maximum out of it

7. Using the remote controller with Radio Frequency

Warning:

To use the remote controller with radio frequency (RF), you need an RF Receiver, which is not included in package.

By default, the remote controller uses infrared (IR) signals to operate devices. This means that you have to point the remote controller's sending eye towards the device you are operating. IR signals have an operating distance of 10 meters (33 feet).

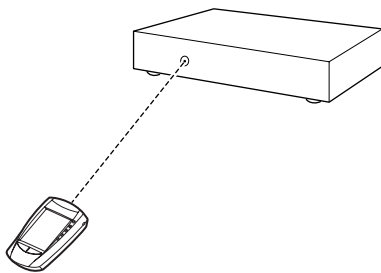

You can select to operate devices using radio frequency (RF) signals instead of IR signals. RF signals have an operating distance of approximately 20 meters (66 feet) in house and , unlike IR signals, is able to go through obstacles like furniture or walls. The RF signals sent out by the remote controller are picked up by the RF Receiver. The RF Receiver translates the RF signals in IR signals and sends the IR signals to the appropriate device.

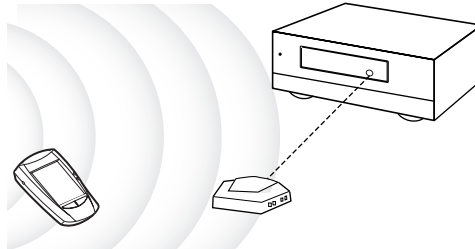

Therefore, the RF Receiver has to be placed near the device you're operating with the RF Receiver's sending eye pointed to the device. Your devices will always receive IR signals either directly from the remote controller or from the RF Receiver.

Getting the Maximum out of it

Changing the remote controller's RF IR Settings

All devices are set up by default to work with IR signals. To be able to operate one or more devices with RF signals, you have to change the remote controller's RF IR settings for those devices.

1. Make sure the Device tab is active.

The Device tab is active when the name of a device is displayed at the right side of the touch screen .

2. Switch to RF IR mode by using the Mode button .

The Device menu appears.

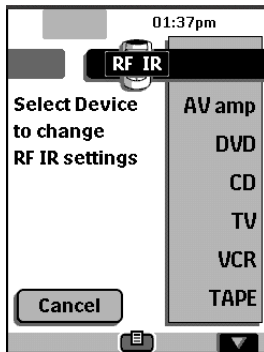

3. Select the device for which you want to change the RF IR settings.

The RF IR settings appear. The white label on the button  indicates that the selected device is currently operated with IR signals.

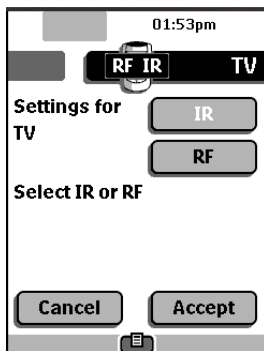

4. Tap **RF**.

The RF IR settings for the selected device are transferable from IR to RF.

When you have only one RF Receiver, you can accept the default settings for the Extender ID and the Channel. Continue with step 5.

or

When you have several RF Receivers to operate devices, you have to assign the correct Extender ID to the selected device. Follow the instructions as described in "Changing the Extender ID".

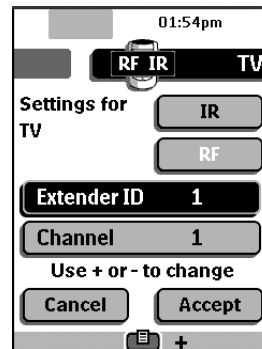

Note:

The ID on the RF Receiver has to match the Extender ID on the remote controller.

Getting the Maximum out of it

Changing the Extender ID

1. Make sure the Extender ID button is active. The button is active when the button label is white.
2. Press the **+** and **-** action buttons to change the Extender ID. The remote controller offers 16 Extender ID's.

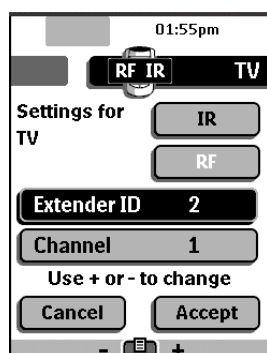

5. Tap **Accept** to save the RF IR settings for the selected device.
or
Tap **Cancel** to return without changing the RF IR settings for the selected device.

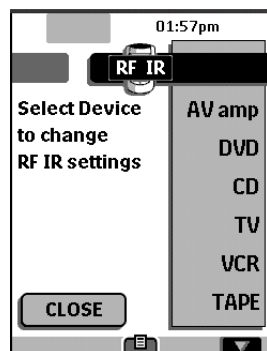

6. Repeat instructions 3 to 5 for all devices for which you want to change the RF IR settings.

7. Tap Close.

The remote controller switches back to Use mode. The remote controller is configured to operate the devices you have set with RF signals.

8. Try the devices which you just changed the RF IR settings.

Note:

There is a possibility that a device does not respond properly when operated with RF signals. This is mostly due to IR signals that cannot be properly transmitted as RF signals. In that case, you have to reconfigure the remote controller to operate the device with IR signals again.

Getting the Maximum out of it

Choosing Another Channel

When you notice RF interference, for instance from your neighbors, you have to choose another channel to operate your devices.

Note:

All devices you want to operate with RF signals use the same channel. If you select another channel for one device, the remote controller will automatically change the channel for all devices that work with RF signals.

1. Switch back to RF IR mode.

The Device menu appears.

2. Select a device that is set with RF signals.

The RF IR settings appear.

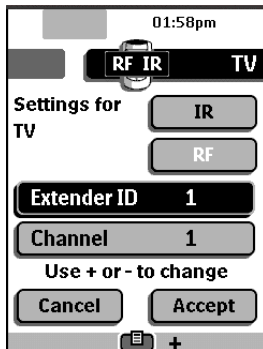

3. Tap **Channel 1**.

The button label turns white indicating that the button is active.

4. Press the **+** and **-** action buttons to change the Channel.

The remote controller offers 4 RF Channels.

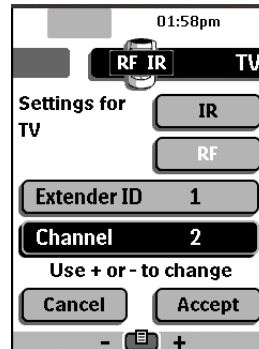

Note:

The Channel (CH) on the RF Receiver has to match the Channel on the remote controller.

5. Tap **Accept** to save the selected Channel for all devices that work with RF signals.

or
Tap **Cancel** to return without changing the Channel.

6. Tap **Close**.

The remote controller switches back to Use mode. The remote controller is configured to operate the devices you have set with RF signals through the selected Channel.

7. Try all devices which you just changed the Channel.

Getting the Maximum out of it

8.ChadEdit

If you want to personalize your remote controller even more, beyond its standard programming features, ChadEdit is the tool for you to use. ChadEdit is the remote controller's companion software that you can download from <http://www.onkyousa.com> www.integrahometheater.com.

With ChadEdit you can:

- upload and download new configurations to and from your remote controller. You do this with the serial cable included with your remote controller;

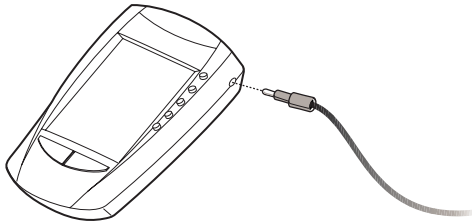

- add, delete, modify and move control panels, devices and commands anywhere on the touchscreen;
- save, duplicate and share configuration files, codes or devices with other remote controllers;
- preview new configuration files on ChadEmulator. In this way you can check how the remote controller's interface will look like.



- import new graphics to create new buttons and designs;
- personalize configuration files to optimize the use of your remote controller.

Getting the Maximum out of it

When you become familiar with ChadEdit, you can achieve results like:

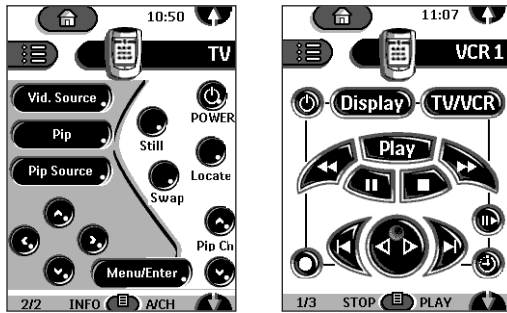

System requirements

- PC
- Windows 95/98/Me, Windows NT 4.0/2000, Windows XP
- 16 MB of RAM
- 16 MB of free hard disk space
- Free serial port

Troubleshooting

General Problems

The display is blank

- Tap the screen to make sure the Remote controller is turned on.
- Adjust the contrast dial on the left side.
- Make sure the batteries are properly installed.
- Install new batteries or recharge the battery pack using the recharging dock.

The display is too light or too dark

- Adjust the contrast dial on the left side.

The Remote controller shuts itself off

- This is a feature of the Remote controller to save power. You can change the length the Remote controller stays on in the Settings (see page 19).

Devices do not respond to commands from the Remote controller

- Make sure the Remote controller is in Use mode (see page 11).
- Make sure the Remote controller's sending eye is pointed towards the device you are operating.
- Check if the Low Battery icon is blinking. If so, replace the batteries or recharge the battery pack.
- Check if the button you are trying to use is programmed properly (see page 23).

The Remote controller beeps 4 times after inserting the batteries

- Use ChadEdit to update the Remote controller's software (ChadEdit > Tools > Update)

Programming Problems

Buttons are not sending the correct commands

- Check whether the button is programmed globally or per device (see page 24).

Macros do not work

- Make sure the Remote controller's sending eye is pointed towards the device the entire time the macro is being executed.
- Insert delays to allow devices to start up properly (see page 21).
- Check if you do not have included inactive buttons in your macro.
- Check if you do not have reprogrammed buttons. Macros can not save commands, they just save buttons. If you reprogram a button, the macro executes the new command assigned to the button.

The TV goes blank or the input source changes

- The Device menu item might be programmed to switch the input source. Operate the device without affecting the input source (see page 17).

The Remote controller will not edit, label or delete commands

- If the label locked appears on the Remote controller icon, the device control panels have been locked to prevent unwanted changes. You cannot modify or delete commands for this device.
- Make sure your devices are positioned as shown on page 23. Avoid programming the Remote controller under bright fluorescent light: it might affect the infrared signals.
- Make sure the button you want to edit has a border. Borderless buttons cannot be programmed.

Troubleshooting

The Remote controller will not switch modes

- When the batteries are low the Remote controller prevents you from switching to customizing modes so that no customization can get lost. Replace the batteries or recharge the battery pack (see pages 9, 10).

The Remote controller is low on memory

- The remote controller displays a message to clean up the memory. The Remote controller will do this by permanently removing devices and macro and timer groups you have deleted.

Warning:

Cleaning up memory will take 10 minutes or longer. Never remove batteries during the clean-up process. This might damage the configuration file resulting in loss of your customized commands.

The configuration file is corrupted

- When this very unlikely event occurs, you have to revert to the original configuration. All your customized commands devices and macros will be lost and you will have to reprogram your remote controller.

Remote controller error messages

- If one of the following error messages occurs, please contact your dealer or the Onkyo customer service:
 - Can not open configuration file
 - Configuration file error
 - No configuration file found
 - Invalid configuration file version

Recharging Problems

The batteries will not recharge

- Make sure you are using the rechargeable battery pack included with your recharging dock and not the AA batteries.

The indicator light blinks

- Check if the contacts on the recharging dock are clean and free of obstructions.
- Make sure the remote controller lies properly on the dock.
- Make sure the battery pack is installed properly in your remote controller (see page 10).

FAQ

Can I program a button to execute more than one command?

No, you can not. However, you can create a macro to execute a sequence of commands (see page 31).

How do I program source switching?

See “Programming device items” on page 24.

How can I edit, label or delete buttons on home panels?

You can do this via the Device menu items. All changes you make to these items are automatically updated in the Home menu.

How do I reset the Remote controller?

Normally, you never have to reset the Remote controller. However, if the Remote controller’s display freezes or if you notice unusual behavior, you might need to reset. You will not lose any saved programmed commands or macros.

- Carefully press the reset button on the back of the Remote controller with a paperclip or sharp pencil. The remote controller restarts and beeps to indicate it is ready for use.

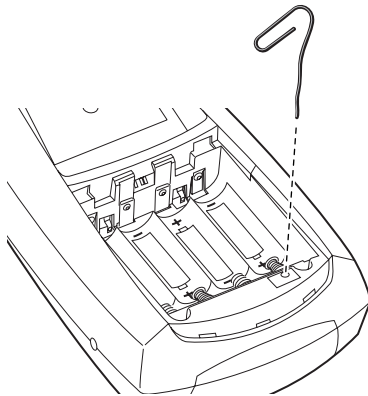

How do I revert to the original configuration?

Reverting to the original configuration restores the remote controller’s devices and commands to its state when you purchased it. This means that all programming is lost permanently. Normally, you never have to revert the Remote controller.

1. Touch and hold the Remote controller icon for a few seconds.

The first setup panel appears.

2. Scroll to the second setup panel.

3. Tap the Revert button.

4. Tap Revert to confirm the action.

How do I calibrate the touchscreen?

The remote controller is calibrated when it leaves the factory, so normally you do not have to calibrate it yourself. It is possible that the remote controller displays a message to calibrate the touchscreen. If this message appears, do the following:

1. Tap as close as possible the upper left corner using a blunt tip of a pencil.

2. Tap as close as possible the upper right corner using a blunt tip of a pencil.

Overview of Symbols

	:Pause		:Page number up
	:Stop		:Page number down
	:Normal run; normal speed		:Page enlargement
	:Normal run; normal speed		:TV and text mixed
	:Fast run; fast speed		:1st or 2nd language
	:Fast run; fast speed		:Last view; previous program
	:Slow run; slow speed		:Stand-by
	:Slow run; slow speed		:Zone focus: long distance
	:Eject		:Zone focus: very short distance
	:Recording, general		:Single or multi-digit selection
	:Key		:Brightness; brilliance
	:Navigate		:Contrast
	:Still mode		:Brightness/contrast
	:Tape running direction		:Color saturation
	:Next track		:Lamp; lighting; illumination
	:Previous track		:Split screen freeze / double screen freeze
	:Fast forward to index		:Split screen swap / double screen swap
	:Rewind to index		:Split screen / double screen
	:Frame by frame, general		:Movie expand
	:Frame by frame, general		:Personal preference
	:Subtitle		:Picture-in-picture freeze
	:Cancel picture		:Main index page
	:Picture-in-picture mode		:Picture freeze
	:Menu		:Programmable timer; general
	:Picture-in-picture shift		:Tracking
	:Picture-in-picture swap		:Application assistance
	:Multi-picture display		:Actual time on screen
	:Picture-in-picture select		:EPG / Electronic Program Guide
	:Teletext mode		:Video output

Specifications

Hardware	High-resolution (320 x 240) liquid crystal display (LCD) with contrast control Large touchscreen Seven programmable direct-access buttons Backlighting for LCD and direct-access buttons Infrared sending and learning eyes 3-wire (RS232) serial port connector
Software	Dynamic, animated interface Editable macros (up to 255 commands per macro) Total number of devices and macros limited only by memory Database with RC codes to operate different brands
Infrared (IR)	Operating distance of 10 meters (33 feet) Learning frequency upto 56 KHz Learning distance 5 cm (2 inch) up to 30 cm (1 foot)
Radio frequency (RF)	Operating distance of approximately 20 meters depending on the surrounding conditions Band:418 MHz Bandwidth: +/-100 kHz 16 Extender ID's and 4 Channels
Memory	2 MB non-volatile flash memory (retains commands when batteries are not present) 512 K SRAM
Batteries	4 AA 1.5V batteries, or one 4,8V rechargeable battery pack
Battery life	Approximately 6 months with typical use
Power management	Power on by tapping the touchscreen, power off automatically management
Dimensions	153.6 x 94.1 x 43.7 mm (6.0 x 3.7 x 1.7 inch)
Operating temperature	0 °C to 50 °C (32 °F to 122 °F)
Accessories	RS232 cable for PC connection 4 AA 1.5 V batteries
Accessories (Not included)	Remote controller recharge package BCC-5 RF Receiver RFR-5

ONKYO CORPORATION

Sales & Product Planning Div. : 2-1, Nisshin-cho, Neyagawa-shi, OSAKA 572-8540, JAPAN
Tel: 072-831-8111 Fax: 072-833-5222

ONKYO U.S.A. CORPORATION

18 Park Way, Upper Saddle River, N.J. 07458, U.S.A.
Tel: 201-785-2600 Fax: 201-785-2650 <http://www.onkyousa.com>

ONKYO EUROPE ELECTRONICS GmbH

Industriestrasse 20, 82110 Germering, GERMANY
Tel: 089-849-320 Fax: 089-849-3265 E-mail: info@onkyo.de

ONKYO CHINA LIMITED

Units 2102-2107, Metroplaza Tower I, 223 Hing Fong Road, Kwai Chung,
N.T., HONG KONG Tel: 852-2429-3118 Fax: 852-2428-9039



D0107-1

