

SR 3254 SR 3256

Instructions for use

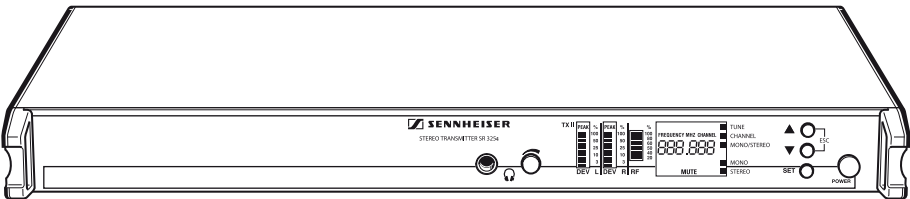

SR 3254

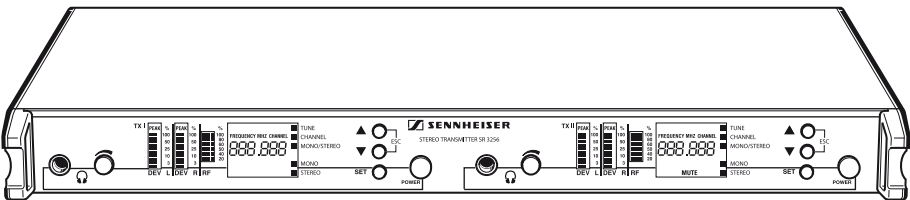

SR 3256

Contents

Safety instructions	2
SR 3254/SR 3256 transmitters	6
Delivery includes	7
Overview of operating controls	8
Indications and displays	9
Preparing the transmitter for use	10
Using the transmitter as a stand-alone unit	10
Rack-mounting several transmitters	11
Connecting the transmitter to the mains	14
Using transmitters in a multi-channel system	15
Using the transmitter	17
Switching the transmitter on/off	17
The operating menu of the transmitter	19
Overview of the operating menu	20
Selecting the frequencies to be stored in the channel bank "U" ...	21
Selecting a channel from the channel bank "U" or "F"	22
Switching between mono and stereo operation	22
Care and maintenance	23
Cleaning the transmitter	23
Replacing the fuse	23
If problems occur	25
Error checklist	25
Additional information	26
Specifications	27
Connector assignment	28
Accessories	29
Manufacturer declarations	30

Thank you for choosing Sennheiser!

We have designed this product to give you reliable operation over many years. Over sixty years of accumulated expertise in the design and manufacture of high-quality electro-acoustic equipment have made Sennheiser a world-leading company in this field.

Please take a few moments to read these instructions carefully, as we want you to enjoy your new Sennheiser products quickly and to the fullest.

Safety instructions

These instructions for use contain important safety information.

Read these instructions.

Keep these instructions in a safe place. Always include these instructions when passing the device on to third parties.

Heed all warnings.

Follow all instructions.

Operation

Use the device in dry rooms only. To reduce the risk of fire or electric shock, do not expose the device to rain or moisture. Objects filled with liquids, such as vases or coffee cups, must not be placed on the device. Do not use the device near water or liquids.

Never spill liquids of any kind onto the device. Should a spillage occur, unplug the device and have it checked by a technician.

Never push objects of any kind through openings of this device as they may touch dangerous voltage points or short-out parts that could result in fire or electric shock.

Ensure sufficient ventilation. Do not block any ventilation openings. Install in accordance with the manufacturer's instructions.

Do not install near any heat sources such as central heating radiators, electric heaters, stoves, or other devices that produce heat (e.g. amplifiers). Keep the device away from direct sunlight and similar sources of heat.

The device is a Class 1 device. It must only be connected to properly grounded power outlets.

This device is supplied with an IEC power cable complete with a moulded mains plug. This is for your safety - do not tamper with the mains. If the supplied cable does not fit your mains socket, please consult a competent electrician for a replacement cable

that matches the power output sockets in your country, or to replace the obsolete socket with one to current standards.

This device should be operated only from the type of power source indicated on the marking label. If you are not sure of the type of power supply to your building, consult your dealer or local power company.

Do not overload wall outlets and extension cords as this may result in fire and electric shock.

Protect the power cord from being walked on or pinched, particularly at plugs, convenience receptacles, and the point where they exit from the device.

Only use attachments/accessories specified by Sennheiser.



Use only with the mountings specified by Sennheiser. When a cart is used, use caution when moving the cart/device combination to avoid injury from tip-over.

Unplug the device during lightning storms or when unused for long periods of time.

Service

No user serviceable parts inside! Do not attempt to service this device yourself as opening or removing covers may expose dangerous voltage or other hazards. If devices are opened by customers in breach of this instruction, the warranty becomes null and void.

Refer all servicing to qualified service personnel. Servicing is required if the device has been damaged in any way, such as mains cable or plug damage, liquid has been spilled, objects have fallen inside, the device has been exposed to rain or moisture, does not operate properly or has been dropped.

Clean only with dry cloth.

Symbols on adhesive labels attached to the device



The adjoining adhesive label is attached to the devices back. The symbols on this label have the following meaning:



This symbol is intended to alert the user to the presence of un-insulated dangerous voltage within the product's enclosure that may be of sufficient magnitude to constitute risk of fire or electric shock.



This symbol is intended to alert the user to the risk of electric shock if the unit cover or back is removed. There are no serviceable parts inside. Refer servicing to qualified personnel only.



This symbol is intended to alert the user to the presence of important operating and maintenance instructions in the literature accompanying this product.

Attention! High volume!



This is a professional transmission system. Commercial use is subject to the safety-at-work regulations. Sennheiser, as the manufacturer, is therefore obliged to expressly point out possible health risks arising from use.

This system is capable of producing sound pressure exceeding 85 dB(A). 85 dB(A) is the sound pressure corresponding to the maximum permissible volume which is by law (in some countries) allowed to affect your hearing for the duration of a working day. It is used as a basis according to the specifications of industrial medicine. Higher volumes or longer durations can damage your hearing. At higher volumes, the duration must be shortened in order to prevent damage. The following are sure signs that you have been subjected to excessive noise for too long a time:

- You can hear ringing or whistling sounds in your ears.
- You have the impression (even for a short time only) that you can no longer hear high notes.

Intended use of the transmitter

Intended use includes

- having read these instructions especially the chapter "Safety instructions".
- using the transmitter within the operating conditions as described in these instructions.

Improper use

Improper use is when you use the transmitter other than described in these instructions or when you use the transmitter under operating conditions different from those described in these instructions.

SR 3254/SR 3256 transmitters

With the wireless in-ear monitoring system, consisting of the SR 3254 or SR 3256 stereo transmitter and the EK 3253 bodypack receiver, musicians, video and sound amateurs, reporters/broadcasters, etc. can directly monitor the received sound signals without troublesome cables or monitor speakers being required. In addition, the system can also be used for any application where talkback signals are to be transmitted.

The system has superb audio quality with an increased signal-to-noise ratio and dynamic range due to the inclusion of Sennheiser's [HDX](#) noise reduction system.



SR 3254

The SR 3254 is a single stereo transmitter in a 19" 1 U housing.

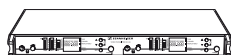

SR 3256

The SR 3256 consists of two complete stereo transmitters in a 19" 1 U housing.

The stereo transmitters have the following features:

- Easy to use
- Stereo/mono selector switch
- Switching bandwidth of 36 MHz per transmitter
- Transmission frequencies tunable in steps of 5 kHz
- [HDX](#) noise reduction system with more than 90 dB signal-to-noise ratio
- LC display for frequency, RF output power and deviation
- Rugged 19" housing with built-in mains unit; supplied with rack-mounting kit
- Suitable for multi-channel applications
- RF output power of up to 100 mW

The channel bank system

The SR 3254/SR 3256 transmitter is available in five UHF frequency ranges:

- Range A: 518 to 554 MHz
- Range B: 626 to 662 MHz
- Range C: 740 to 776 MHz
- Range D: 786 to 822 MHz
- Range E: 830 to 866 MHz

The transmitter has two channel banks with up to 16 switchable channels each. The channels of the channel bank “F” (fixed bank) have been factory-preset to customer-specific transmission frequencies. These frequencies cannot be changed.

The channel bank “U” (user bank) allows you to freely select and store frequencies.

Recommended receiver

- EK 3253

Delivery includes

- 1 SR 3254 transmitter or
1 SR 3256 twin transmitter
- 1 rack-mounting kit
- 1 mains cable
- 1 telescopic antenna (with the SR 3254)
or
2 telescopic antennas (with the SR 3256)
- Instructions for use

Overview of operating controls

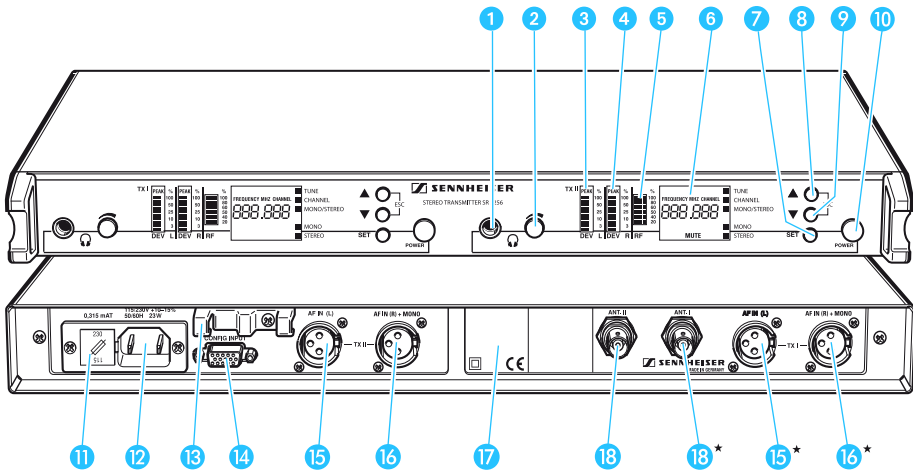

- 1 Headphone output, ¼" (6.3 mm) jack socket
- 2 Headphone volume control
- 3 LCD bargraph for deviation of the left channel (DEV L), with overmodulation display ("PEAK")
- 4 LCD bargraph for deviation of the right channel and "MONO" (DEV R), with overmodulation display ("PEAK")
- 5 LCD bargraph for RF output power (RF)
- 6 Alphanumeric LC display
- 7 SET button
- 8 ▲ button (UP)
- 9 ▼ button (DOWN)
- 10 POWER button
- 11 Fuse holder and mains voltage selection (230 or 115 V)
- 12 2-pin IEC mains connector
- 13 Cable grip for mains cable
- 14 Programming interface, 15-pin sub-D socket
- 15 Audio input, left (AF IN (L))
- 16 Audio input, right (AF IN (R) + MONO)
- 17 Type plate
- 18 Antenna output

Note:

Connections and operating controls marked with a star (★) in the above illustration are those for the second transmitter of the SR 3256 twin transmitter.

Indications and displays

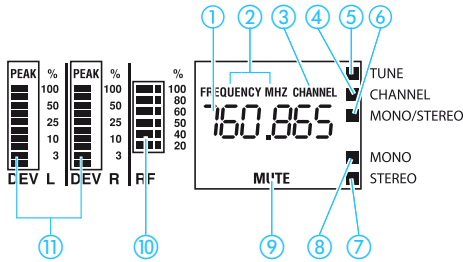

- ① Alphanumeric display
- ② "FREQUENCY MHZ" display
- ③ "CHANNEL" display
- ④ LC dot CHANNEL
- ⑤ LC dot TUNE
- ⑥ LC dot MONO/STEREO
- ⑦ LC dot STEREO (transmitter is set to stereo operation)
- ⑧ LC dot MONO (transmitter is set to mono operation)
- ⑨ MUTE display (transmitter is muted)
- ⑩ 6-step bargraph for RF output power
- ⑪ 11-step deviation bargraph (two separate bargraphs for the left and right channel)

Deviation display

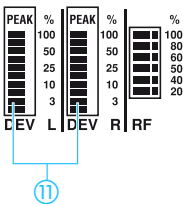

The two bargraphs ⑪ indicate the deviation of the audio signal of the left and right channel. When the transmitter's audio input level is excessively high, "PEAK" lights up.

Display of the RF output power

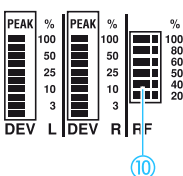

The bargraph ⑩ indicates the RF output power. During normal operation, an RF output power of 100 % is indicated.

Preparing the transmitter for use

Using the transmitter as a stand-alone unit

Mounting the transmitter feet

To ensure that the transmitter cannot slip on the surface on which it is placed, four self-adhesive soft rubber feet are supplied.

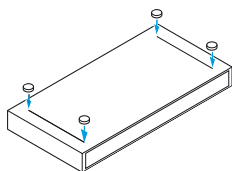

- ▶ Ensure that the base of the transmitter is clean and free from grease before mounting the rubber feet.
- ▶ Fix the rubber feet to the base of the transmitter by peeling of the safety paper and fitting them as shown in the diagram on the left.

Attention!

Some furniture surfaces have been treated with varnish, polish or synthetics which might cause stains when they come into contact with other synthetics. Despite a thorough testing of the synthetics used by us, we cannot rule out the possibility of staining.

Connecting the telescopic antenna

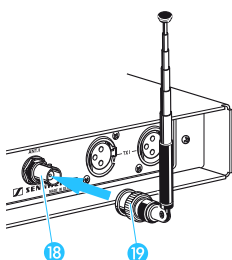

When using the transmitter as a stand-alone unit, connect the supplied telescopic antenna 19. The telescopic antenna can be mounted quickly and easily and is suitable for all applications where – good transmission conditions provided – a wireless transmission system is to be used without a large amount of installation work.

- ▶ Connect the telescopic antenna to the BNC socket 18 at the rear of the transmitter.
- ▶ Pull the end cap to extend the telescopic antenna.

Optimum transmission and reception conditions can be obtained by using remote antennas (see "Mounting and connecting remote antennas" on page 16).

Rack-mounting several transmitters

You can use the supplied rack mount “ears” to mount the transmitter into a 19" rack (1 U). If you wish to mount the antennas to the front of the rack, use the GA 3030-AM antenna mount (see “Accessories” on page 29).

When rack-mounting the device, please consider that, during operation, the ambient temperature within the rack may significantly rise above room temperature. However, the ambient temperature within the rack must not exceed the temperature limit specified in the specifications.

When rack-mounting the device, take good care not to affect the ventilation required for safe operation or provide additional ventilation.

When rack-mounting the device, ensure that its housing is not mechanically loaded and that it is adequately supported at the rear, e.g. for transport.

When connecting the device to the power supply, observe the information indicated on the type plate. Avoid circuit overloading. If necessary, provide overcurrent protection.

Ensure a reliable mains ground connection of the device by taking appropriate measures.

When rack-mounting the device, please note that intrinsically harmless leakage currents of the individual devices may accumulate, thereby exceeding the allowable limit value. As a remedy, ground the rack via an additional ground connection.

Setting up the transmitters

The SR 3254 and SR 3256 transmitters heat up during operation.

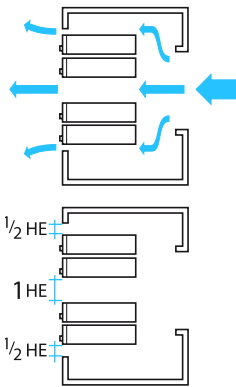

- Ventilation in fixed installations
Ensure sufficient ventilation, especially when the transmitters are mounted into a desk or chassis. Provide for a duct of sufficient size to ensure a free air flow between the transmitters.
- Sufficient ventilation in a rack
When operating several transmitters in a rack, ensure sufficient ventilation or cooling. We recommend not stacking more than two transmitter directly one above the other, and then providing for a duct of sufficient size to ensure a free air flow between the transmitters.

Rack-mounting the transmitter without mounting the antennas to the front of the rack

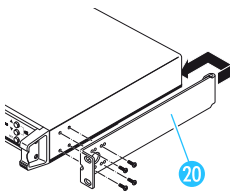

- ▶ Hook the two rack mount "ears" 20 to the rear of the transmitter.
- ▶ Secure the rack mount "ears" to the left and right of the transmitter using four recessed head screws respectively.
- ▶ Slide the transmitter into the 19" rack.
- ▶ Secure the rack mount "ears" 20 to the rack.

Rack-mounting the transmitter and mounting the antennas to the front of the rack

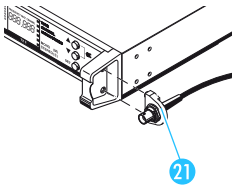

- ▶ Mount the antenna holders 21 to the handles of the transmitter as shown in the diagram on the left.

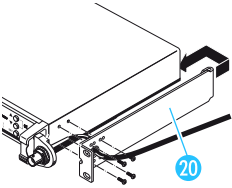

- ▶ Hook the two rack mount "ears" 20 to the rear of the transmitter.

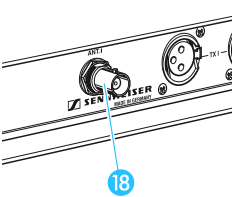

- ▶ Pull the cables of the antenna holders 21 through the holes in the rack mount "ears".
- ▶ Secure the rack mount "ears" to the left and right of the transmitter using four recessed head screws respectively.
- ▶ Connect the cables of the antenna holders to the antenna sockets 18 at the rear of the transmitter.

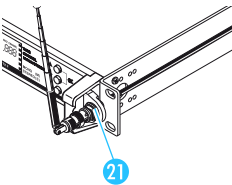

- ▶ Slide the transmitter into the 19" rack.
- ▶ Connect the telescopic antennas to the BNC sockets of the antenna holders 21.

Connecting the transmitter to the mains

The transmitter can be connected to 230 V or 115 V AC. Before you plug the mains connector into the wall socket, please first check that the transmitter is set to the correct mains voltage!

The set voltage is shown at the top of the fuse holder **11**.

Selecting the mains voltage

WARNING! Electric shock hazard!



In case of improper handling, you may come into contact with electrically conducting parts and receive an electric shock when removing the fuse holder.

- ▶ Before removing the fuse holder, pull out the mains connector from the wall socket.

To select the mains voltage, proceed as follows:

- ▶ Disconnect the transmitter completely from the mains by pulling out the mains connector from the wall socket.
- ▶ Use a screwdriver to loosen the fuse holder **11**.
- ▶ Remove the fuse holder with the inserted fuse.
- ▶ Turn the fuse holder by 180° and reinsert it.

The set voltage is shown at the top of the fuse holder.

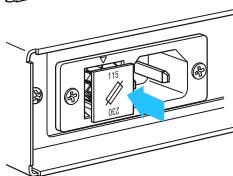
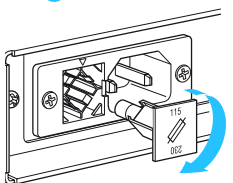
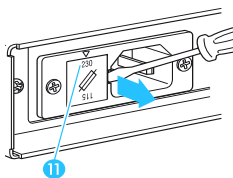

Connecting the mains cable

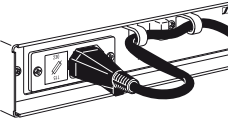

- ▶ Insert the supplied mains cable into the socket on the transmitter and pass the cable through the cable grip.

Note

A cable grip is particularly important when the transmitter is permanently rack-mounted. Inside the rack there are often a large number of cables – a cable grip prevents the cables from pulling each other out.

Using transmitters in a multi-channel system

You can combine several transmitters to make a multi-channel system. To do so, you require an antenna combiner (e.g. the AC 3000, see “Accessories” on page 29) which allows you to combine the signals of up to four twin receivers onto a single antenna (see diagram below). For detailed information on setting up a multi-channel system and on connecting the transmitters, please refer to the operating manual of the antenna combiner.

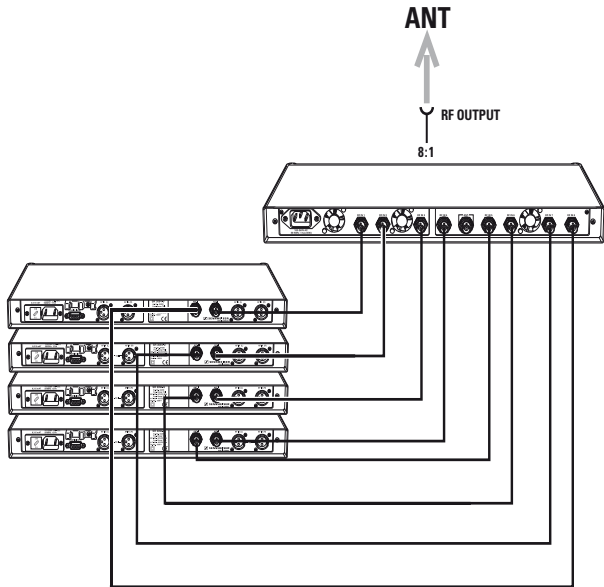

Mounting and connecting remote antennas

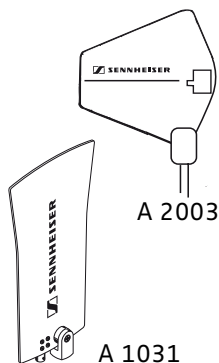

Use a remote antenna when the transmitter position is not the best antenna position for optimum transmission. You can choose between two antennas (see “Accessories” on page 29):

- A 2003 UHF passive directional antenna
- A 1031 passive omni-directional antenna

Use a low-attenuation 50-Ω cable to connect the antenna to the transmitter. Ready-made antenna cables from Sennheiser are available as accessories with length of 5 m and 10 m. If possible, use a short antenna cable and as little connections as possible, since long cables and many connectors lead to an attenuation of the antenna signal. Position antennas in the same room in which the transmission takes place! Maintain a minimum distance of 1 m from metal objects (including reinforced concrete walls)!

Connecting the mixing console

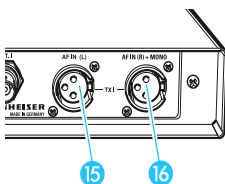

Connect the mixing console to the XLR-3 sockets AF IN (L) 15 and AF IN (R) + MONO 16.

Note

Any unit that is only suitable for mono operation must be connected to the XLR-3 socket AF IN (R) + MONO 16. In this case, set the transmitter to mono operation (see “Switching between mono and stereo operation” on page 22).

Using the transmitter

Switching the transmitter on/off

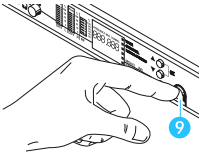

- ▶ Press the **POWER** button 9 to switch the transmitter on or off.

After switch-on, the LC display is backlit and the last transmission frequency set is displayed.

Until the PLL has locked on the desired transmission frequency, the transmitter is muted. "MUTE" appears on the display and the LCD bargraph for RF output power (RF) 5 indicates 0 %.

Note

The **POWER** button 9 works in the secondary circuit of the integrated mains transformer, and thus only switches the low voltage side. For larger installations with several transmitters, a complete mains disconnection can best be achieved by a central ON/OFF switch.

Connecting the headphones/monitoring the audio signal

Attention! High volume!

Even short exposure to high volume levels can damage your hearing! Set the volume for the connected headphones to the minimum before putting the headphones on. Do not listen at higher volume levels than with loudspeakers.

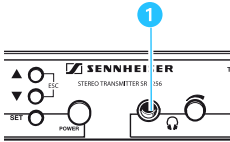

- ▶ Connect headphones with a 1/4" (6.35 mm) stereo jack plug to the headphone output 1 to monitor the stereo audio signal present at the audio inputs 15 AF IN (L) and 16 AF IN (R) + MONO.

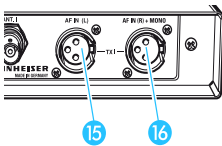

Note

Even during mono operation, the left and right channel are reproduced separately via the headphones.

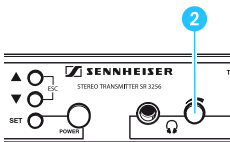

- ▶ First, set the volume control 2 to the lowest volume by turning it to the left as far as possible. Then gradually turn up the volume.

The operating menu of the transmitter

Via the operating menu, you can quickly and easily change the following settings:

Menu	Function of the menu
TUNE	Setting a transmission frequency for the channel bank "U" (user bank)
CHANNEL	Selecting a channel from the channel bank "U" or "F"
MONO/STEREO	Switching between mono and stereo operation

The buttons

In the operating menu, all settings can be made using the ▲, ▼ and SET buttons:

Buttons	Mode	Function of the button
▲/▼	Display mode	Selects a menu.
	Setting mode	<ul style="list-style-type: none">Briefly pressing the button: The display jumps either forwards or backwards to the next setting.Holding down the button ("TUNE" and "CHANNEL" menu): The display cycles continuously ("fast search" function). The "fast search" function allows you to get fast and easily to your desired setting.
SET	Display mode	Changes to the setting mode of the selected menu.
	Setting mode	<ul style="list-style-type: none">Stores the setting and returns to the display mode.In the "TUNE" menu: Confirms the selection of the channel for which you want to set the frequency.

Canceling an entry

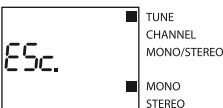

When in the setting mode of a menu, you can cancel your entry at any time by pressing the ▲ and ▼ buttons simultaneously. The cancellation is briefly confirmed on the display with "ESc."

The previous setting is kept and the transmitter returns to the display mode.

Overview of the operating menu

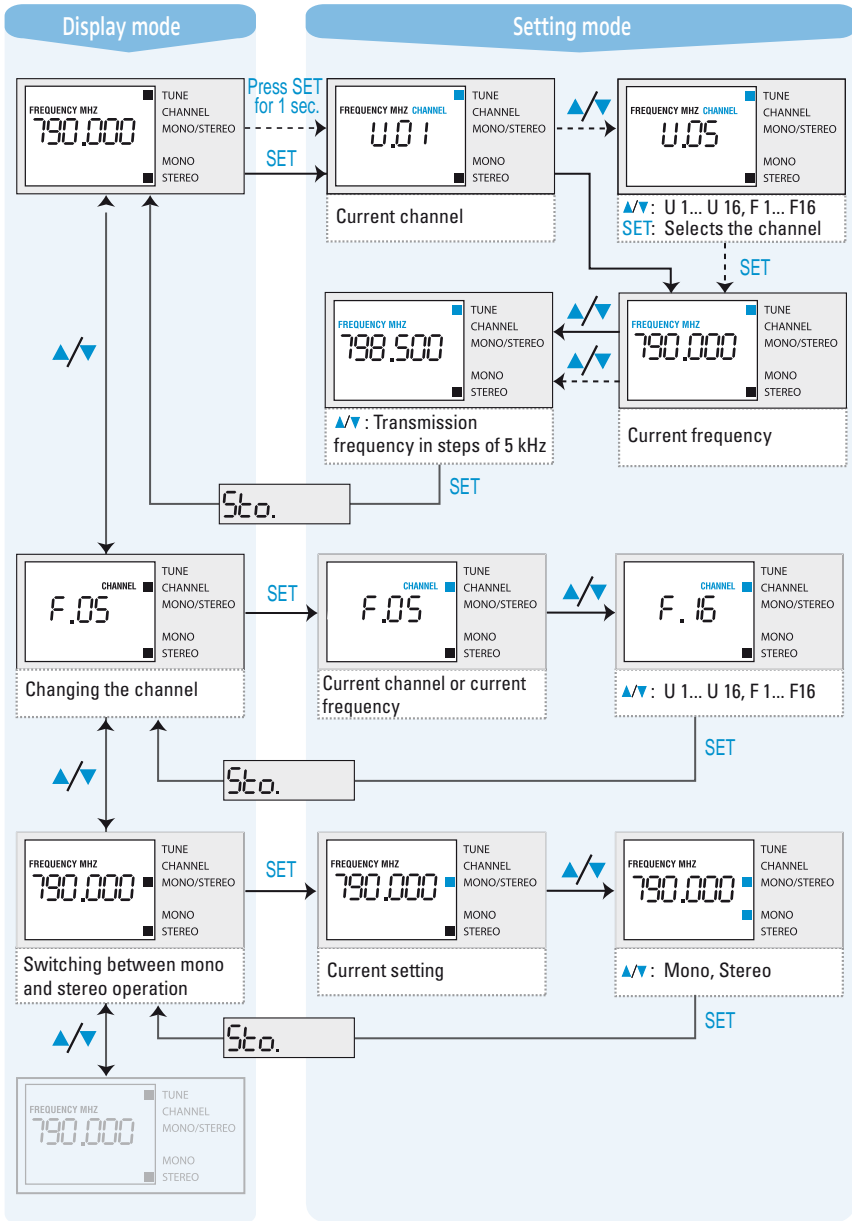

TUNE Selecting the frequencies to be stored in the channel bank "U"

Via the "TUNE" menu, you can freely select the frequencies to be stored in the channel bank "U" (user bank).

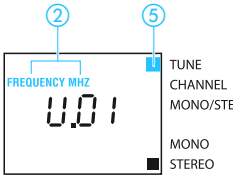

- ▶ Press the ▲/▼ buttons to select the "TUNE" menu. The LC dot "TUNE" ⑤ lights up.
- ▶ Press the SET button to get into the setting mode of the "TUNE" menu.

The LC dot "TUNE" ⑤ and the "FREQUENCY MHZ" display ② start flashing.

Note

When pressing the SET button for one second, you can use the ▲/▼ buttons to select a different channel for which you can then change the frequency.

When you have selected the channel bank "F" and then select the "TUNE" menu, the transmitter automatically switches to channel 01 of the channel bank "U" and "U.01" appears on the display. Otherwise, the current channel of the channel bank "U" is displayed.

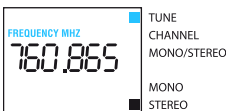

- ▶ Press the ▲/▼ buttons to select the desired transmission frequency. Transmission frequencies are tunable in 5-kHz steps within a switching bandwidth of 36 MHz max.

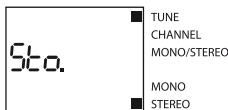

- ▶ Press the SET button to store your selection. "Sto." briefly appears on the display. While the transmitter changes to the new frequency, it is muted.

CHANNEL Selecting a channel from the channel bank “U” or “F”

- ▶ Press the ▲/▼ buttons to select the “CHANNEL” menu.

The LC dot “CHANNEL” ④ and the “CHANNEL” display ③ light up.

- ▶ Press the SET button to get into the setting mode.
- ▶ Press the ▲/▼ buttons to select the desired channel.

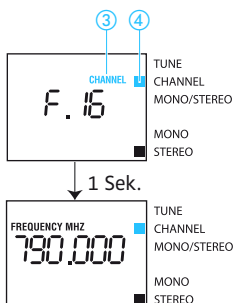

- ▶ Press the SET button to store your selection. “Sto.” briefly appears on the display.

MONO/STEREO Switching between mono and stereo operation

- ▶ Press the ▲/▼ buttons to select the “MONO/STEREO” menu.

The LC dot “MONO/STEREO” ⑥ lights up.

- ▶ Press the SET button to get into the setting mode.
- ▶ Press the ▲/▼ buttons to select the desired operating mode.

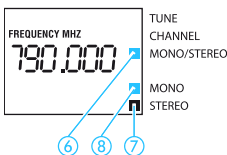

- ▶ Press the SET button to store your selection. “Sto.” briefly appears on the display.

Care and maintenance

Cleaning the transmitter

CAUTION!

Water can damage the electronics of the transmitter!



Water entering the housing of the transmitter can cause a short-circuit and damage the electronics.

- ▶ Only use a slightly damp cloth to clean the transmitter.

- ▶ Before cleaning, disconnect the transmitter from the mains.
- ▶ If necessary, you can clean the transmitter with a slightly damp cloth. Do not use any cleansing agents or solvents.

Replacing the fuse

WARNING!

Electric shock hazard!



In case of improper handling, you may come into contact with electrically conducting parts and receive an electric shock when removing the fuse holder.

- ▶ Before removing the fuse holder, pull out the mains connector from the wall socket.

- ▶ Disconnect the transmitter completely from the mains by pulling out the mains connector from the wall socket.
- ▶ Use a screwdriver to loosen the fuse holder **ii**.
- ▶ Remove the fuse holder with the inserted fuse.
- ▶ Replace the fuse by a new fuse with the same rating.
- ▶ Reinsert the fuse holder. Make sure to insert the fuse holder the correct way round.

The set voltage is shown at the top of the fuse holder.

- ▶ Reconnect the transmitter to the mains and switch it on again.

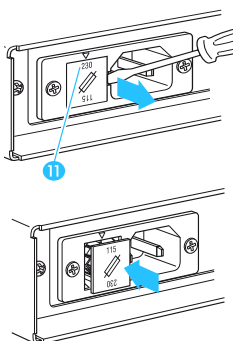

If the replacement fuse also blows, please contact your local Sennheiser agent or send the transmitter, with a precise description of the trouble, to a Sennheiser service partner in your area. You can find the address of your nearest service partner in the enclosed service card or on the Internet at

["http://www.sennheiser.com/sennheiser/icm.nsf/root/service_partner"](http://www.sennheiser.com/sennheiser/icm.nsf/root/service_partner).

If problems occur ...

Error checklist

Problem	Possible cause	Possible solution
No operation indication	No mains connection	Check the connections of the mains connector
	Fuse is defective	Replace the fuse
No RF signal	Transmitter and receiver are not on the same channel	Set transmitter and receiver to the same channel
	Transmitter is out of range	Change the antenna position
RF signal available, no audio signal	Transmitter is set to mono operation and the pilot tone evaluation of the receiver is activated	Deactivate the pilot tone evaluation on the receiver
	Receiver's squelch threshold is adjusted too high	Reduce the squelch threshold on the receiver
Audio signal has a high level of background noise or is distorted	Transmitter sensitivity is adjusted too low or too high	See "Connecting the mixing console" on page 16

If problems occur that are not listed in the above table or if the problems cannot be solved with the proposed solutions, please contact your local Sennheiser agent for assistance.

Additional information

HDX noise reduction

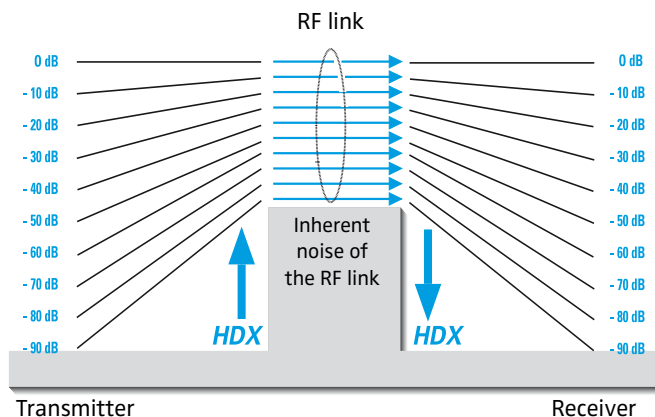

Progress you can hear:

The product family is equipped with **HDX**, the Sennheiser noise reduction system that reduces RF interference. It increases the signal-to-noise ratio in wireless audio transmission to more than 90 dB.

HDX is a wideband compander system which compresses the audio signal in the transmitter in a 2:1 ratio (related to dB) to lift it above the inherent noise floor of the RF link. In the receiver the signal is expanded in an identical and opposite way in a 1:2 ratio to restore the original signal, at the same time reducing the RF noise to below the noise floor of the receiver.

HDX has been specially developed for high quality radio microphone systems.

Note:

Only transmitters and receivers that are equipped with **HDX** can work correctly with each other. If non HDX equipment was mixed with **HDX**, the dynamic range would be drastically reduced and the transmission would sound blunt and flat.

Specifications

RF characteristics

Frequency ranges	518–554, 626–662, 740–776, 786–822, 830–866 MHz
Transmission frequencies	1 channel bank with up to 16 factory-preset channels 1 channel bank with up to 16 freely selectable channels (frequencies tunable in steps of 5 kHz)
Switching bandwidth	36 MHz
Frequency stability	± 10 ppm (-10°C to $+55^{\circ}\text{C}$)
Antenna output	BNC socket, $50\ \Omega$
RF output power	max. 100 mW

AF characteristics

Modulation	FM stereo working on the pilot tone principle
Noise reduction system	Sennheiser HDX
Nominal/peak deviation	± 24 kHz / ± 48 kHz
MPX pilot tone (frequency/deviation)	19 kHz / ± 5 kHz
AF frequency response	40–15,000 Hz
Headphone output	$\frac{1}{4}$ " (6.35 mm) stereo jack socket, ≥ 200 mW/ $32\ \Omega$
Load impedance of headphone output	$\geq 16\ \Omega$
AF input	2 x XLR-3, electronically balanced
AF input voltage (at nom. deviation)	+4 dBu at 1 kHz, internally adjustable
Signal-to-noise ratio	> 90 dB(A) _{rms} (refers to overall link with EK 3253)
THD (at 1 kHz and nominal deviation)	$< 0.9\ \%$

Note:

The above data also apply to the second transmitter in the SR 3256.

Overall unit

Power supply

115/230 V AC +10% / -15%

Power consumption SR 3254

max. 13 W

Power consumption SR 3256

max. 23 W

Dimensions

436 x 228 x 43 mm (19", 1 U)

(without rack mount "ears")

Weight SR 3254

approx. 3,300 g

Weight SR 3256

approx. 4,000 g

Type approval

USA: FCC-Part 74.861

FCC ID: DMOSREK3K

Canada: RSS-123

IC: 2099A-SREK3K

EU: ETSI EN 300 454-1/-2

CE 0682!

Connector assignment

SR 3254/SR 3256

1/4" (6.35 mm) stereo jack plug
for headphone output

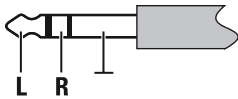

XLR-3 connector (male)

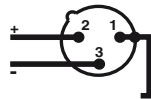

Accessories

- AC 3000-EU** Active Antenna combiner Cat. no. 009424
- AC 3000-UK** Active Antenna combiner Cat. no. 009410
- AC 3000-US** Active Antenna combiner Cat. no. 094409
- A 1031-U** Passive omni-directional antenna Cat. no. 004645
- GA 3030-AM** Antenna mount Cat. no. 004368
- A 2003 UHF** Passive directional antenna Cat. no. 003658
- GZL 1019 A5** BNC-BNC coaxial cable, length 5 m Cat. no. 002325
- GZL 1019 A10** BNC-BNC coaxial cable, length 10 m Cat. no. 002326
- GZV 1019A** BNC coupler Cat. no. 002368
- HD 25** Monitoring headphone Cat. no. 002976
- EK 3253 A** Monitoring receiver Cat. no. 500522
- EK 3253 B** Monitoring receiver Cat. no. 500523
- EK 3253 C** Monitoring receiver Cat. no. 500524
- EK 3253 D** Monitoring receiver Cat. no. 500525
- EK 3253 E** Monitoring receiver Cat. no. 500526

Manufacturer declarations

Warranty regulations

The guarantee period for this Sennheiser product is 24 months from the date of purchase. Excluded are accessory items, rechargeable or disposable batteries that are delivered with the product; due to their characteristics these products have a shorter service life that is principally dependent on the individual frequency of use.

The guarantee period starts from the date of original purchase. For this reason, we recommend that the sales receipt be retained as proof of purchase. Without this proof (which is checked by the responsible Sennheiser service partner) you will not be reimbursed for any repairs that are carried out.

Depending on our choice, guarantee service comprises, free of charge, the removal of material and manufacturing defects through repair or replacement of either individual parts or the entire device. Inappropriate usage (e.g. operating faults, mechanical damages, incorrect operating voltage), wear and tear, force majeure and defects which were known at the time of purchase are excluded from guarantee claims. The guarantee is void if the product is manipulated by non-authorized persons or repair stations.

In the case of a claim under the terms of this guarantee, send the device, including accessories and sales receipt, to the responsible service partner. To minimise the risk of transport damage, we recommend that the original packaging is used. Your legal rights against the seller, resulting from the contract of sale, are not affected by this guarantee.

The guarantee can be claimed in all countries outside the U.S. provided that no national law limits our terms of guarantee.

CE Declaration of Conformity



This equipment is in compliance with the essential requirements and other relevant provisions of Directives 1999/5/EC, 89/336/EC or 73/23/EC. The declaration is available on the internet site at www.sennheiser.com.

Before putting the device into operation, please observe the respective country-specific regulations!

WEEE Declaration



Your Sennheiser product was developed and manufactured with highquality materials and components which can be recycled and/or reused. This symbol indicates that electrical and electronic equipment must be disposed of separately from normal waste at the end of its operational lifetime.

Please dispose of this product by bringing it to your local collection point or recycling centre for such equipment. This will help to protect the environment in which we all live.



Sennheiser electronic GmbH & Co. KG
30900 Wedemark, Germany
Phone +49 (5130) 600 0
Fax +49 (5130) 600 300
www.sennheiser.com