

Operators Manual

**UMP45 (.45 ACP)
UMP40 (.40 S&W)**



In a world of compromise, some don't.

HK UMP Submachine Gun

**CAUTION: Read the safety rules before handling the
UMP Submachine Gun!**

UMP

Universal Submachine Gun Operators Manual

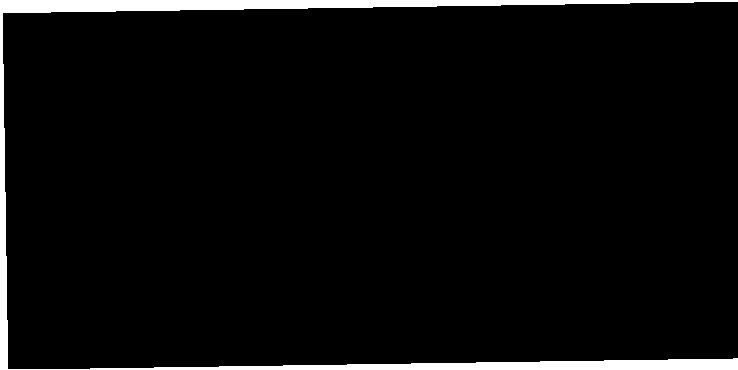

© Heckler & Koch, Inc., 10/1999, Revised August 2000
All rights reserved
HK, Inc., 21480 Pacific Blvd.
Sterling, Virginia 20166-8903
United States of America
Telephone (703) 450-1900 • Fax (703) 450-8160
www.hecklerkoch-usa.com
Specifications and models subject to change without notice.

TABLE OF CONTENTS

Safety Rules on the Use of the HK UMP Submachine Gun	6
General	8
Assembly Groups	10
Description of Assembly Groups	11
Assembly Group 1 Upper Receiver with barrel, folding buttstock and attachment components	11
Assembly Group 2 Bolt Group	12
Assembly Group 3 Lower Receiver with trigger mechanism	14
Assembly Group 4 Magazine	16
Accessories	17
Carrying Sling.....	17
Cleaning Kit	17
Special-purpose Accessories	17
Sound Suppressor	17
Mounting Rails for Aiming Devices according to MIL-STD-1913.....	17
Handstop	17
Magazine Loader	18
Handling and Operation	18
Filling the Magazine	18
Filling the Magazine using the Magazine Loader	18
Emptying the Magazine	19
Insertion and Removal of the Magazine	19
Loading the Submachine Gun	20
Forward Assist	22
Storage of the Weapon	23
Disassembly of the UMP	24
Safety Check	24
Disassembly into Assembly Groups	24
Disassembly and Assembly of the Bolt Group.....	26
Disassembly and Assembly of the Magazine	27
Reassembly of the UMP	28
Function Check	29
Operator Cleaning	30
Normal Cleaning	31

TABLE OF CONTENTS

Major Cleaning	33
Operator Inspection	34
Lubrication	34
Special Use and Maintenance of HK Sound Suppressed Weapons ..	35
UMP with Quick Connect Sound Suppressor	36
Ammunition	38
Stoppages	38
Troubleshooting Guide	39
Carrying Sling	41
Carrying Modes	43
Firing Positions	44
Sight Alignment for the UMP	45
Specifications	47
Exploded Diagram and Parts List	48
Weapon Service Record	50

UMP SAFETY RULES

Safety Rules on the use of the HK UMP Submachine Gun

Clear the weapon! Before handling the weapon, “clear it!” Do so by:

- **Make sure fingers are outside of the trigger guard and the weapon is pointed in a safe direction at all times!**
- **ON SAFE – Rotate the safety/selector lever to the “Safe” position. (With the safety/selector lever set at the white box with a white bullet symbol inside. See illustrations on page 12).**
- **REMOVE MAGAZINE – Depress the magazine release lever and remove the magazine from the magazine well.**
- **COCKING LEVER – Rotate the ejection port towards the ground and pull the cocking lever rearward one or more times to insure the chamber is empty. Watch for a live round or empty case to be ejected. Rotate the cocking lever upward slightly and lock it into the indent in the cocking lever housing to lock the bolt open.**
- **INSPECT CHAMBER – Inspect chamber for the presence of a live round or empty case.**
Visually – View chamber through open ejection port.
Physically – Insert index finger through magazine well or ejection port and feel for the presence of a round or cartridge case in the chamber.
Remove any live rounds or empty cases from the chamber or from within the weapon or magazine before handling the weapon further.

The HK UMP submachine gun is now considered “Clear”.

WARNINGS

- **When handling submachine guns special caution is necessary as the position and direction of the submachine gun can be changed easily.**
- **Carefully read this operators manual before handling the submachine gun.**
- **Only use the submachine gun after you have fully reviewed and understand these instructions.**
- **Observe all notes on handling and operation. Failure to do so may result in injury or death of the operator or bystanders.**
- **Do not use the submachine gun if you have previously ingested alcohol, drugs or medication.**
- **When passing the submachine gun between persons, the weapon must be clear and the bolt should be open.**
- **Always treat the submachine gun as if it were loaded and ready**

UMP SAFETY RULES

to fire.

- **Never point the submachine gun at anyone during handling.**
 - **Always point the submachine gun in a safe direction.**
 - **Before handling and before cleaning it has to be checked to ensure that:**
 - **The bolt is locked to the rear**
 - **The submachine gun is unloaded (cartridge chamber empty)**
 - **The barrel is free of obstructions**
 - **The magazine is empty.**
 - **Keep your finger off the trigger when loading, unloading or otherwise handling the submachine gun. Always place the trigger finger outside of the trigger guard.**
 - **Place your finger on the trigger only when your sights are aimed at the target.**
 - **Never use force when handling, disassembling, cleaning and assembling the submachine gun.**
 - **Disassemble the submachine gun only as far as described in this manual.**
 - **A handstop is provided with each UMP to keep the nonfiring hand or fingers away from the muzzle of the weapon. This handstop should be used at all times and can be mounted on the weapon with or without the mounting rails attached.**
 - **Always wear eye protection when using the submachine gun.**
 - **Always wear hearing protection when using the submachine gun.**
 - **Take into account the fact that bystanders are also endangered. Ensure bystanders are also wearing ear and eye protection.**
 - **Only use factory-loaded and undamaged cartridges of the correct caliber.**
 - **Always mind that the muzzle area is free of obstacles during firing.**
 - **Store the weapon and ammunition in separate places.**
 - **Heckler & Koch does not assume liability for events due to disregarding this manual, improper handling, negligence, improper treatment, unauthorized exchange of parts or manipulations of the submachine gun.**
 - **Read this operators manual and be familiar with the safe handling of this weapon before using it. Keep this manual with the submachine gun.**
-

UMP SUBMACHINE GUN

General

The UMP Submachine Gun is a select-fire small arm manufactured according to the latest standards of manufacturing methods. The upper receiver, lower receiver, magazine, and folding buttstock are made of high strength polymer. The UMP allows single fire, limited bursts, or fully automatic fire to be fired from all positions. The UMP is a simple blowback operated weapon with fixed barrel.

The UMP offers maximum safety and accuracy as it fires from the closed bolt position. The UMP is easily disassembled into its main assembly groups for cleaning and care without the use of tools.

Accessories

The following accessories are available:

- sound suppressor
- mounting rails for aiming devices
- magazine loader
- handstop
- multi-purpose carrying sling
- tactical lights

Other accessories may also be available, please contact HK for more information.



Fig. 1 UMP with buttstock open, left side view

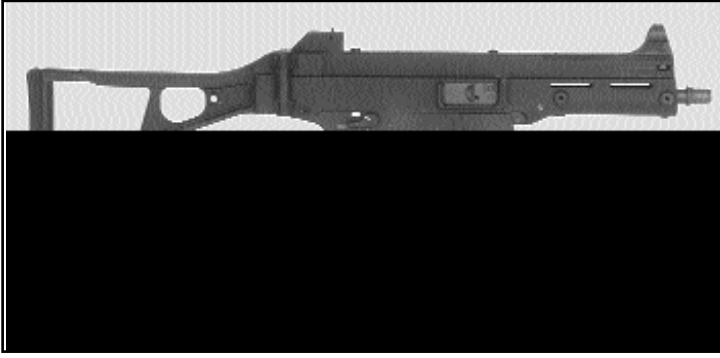

Fig. 2 UMP with buttstock open, right side view



Fig. 3 UMP with buttstock folded, right side view



Fig. 4 UMP with carrying sling, left side view

UMP SUBMACHINE GUN

Assembly Groups

- 1 Upper receiver with barrel, folding buttstock and attachment components
- 2 Bolt Group with recoil spring assembly, complete
- 3 Lower receiver with trigger mechanism, backplate and magazine well
- 4 Magazine

For accessories see pages 15-16



Fig. 5 UMP Assembly Groups (4)

DESCRIPTION OF ASSEMBLY GROUPS

Assembly Group 1

Upper receiver with barrel, folding buttstock attachment components

The upper receiver is produced using fiber-reinforced plastics and houses other subassemblies. The inside of the upper receiver contains metal guideways for the bolt group as well as attachment points for the lower receiver with magazine well and backplate.

The barrel is inserted into and pinned to the upper receiver. The cocking lever of the weapon is located above the barrel. It also serves to manually lock the bolt in its open position. The right side of the upper receiver contains the ejection port. The ejection port includes an integral catch for engagement of the buttstock in its folded position.

The bottom part of the upper receiver includes the support bolts for the lower receiver. The left side of the upper receiver includes eyebolts for attachment of the carrying sling.

The sights are fastened to the top of the upper receiver. They consist of a flip-up type rear sight with diopter (peep) and u-notch apertures as well as of the front sight post with front sight hood. The rear of the upper receiver includes the hinge for the folding buttstock.

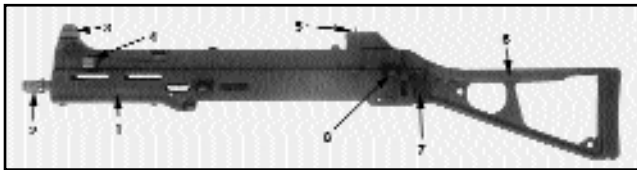

Fig. 6 Upper Receiver with barrel, folding buttstock and attachment components

- | | |
|------------------|------------------------------------|
| 1 Upper receiver | 5 Flip-up rear sight |
| 2 Barrel | 6 Buttstock |
| 3 Front sight | 7 Buttstock release button |
| 4 Cocking lever | 8 Carrying sling attachment points |

Buttstock

The buttstock folds to the right along the upper receiver, and with the stock folded, the UMP is only 17.72 inches (450 mm) long. The open frame-type design of the buttstock also enables the weapon to be fired with the buttstock folded.

Pressing the catch releases the buttstock for folding. When folded, the buttstock engages on the catch located on the forward part of the ejection port. For unfolding, the buttstock is lifted off the catch.

The buttplate has a rubber pad to ensure non-slip contact with the shoulder. This cheek piece is also rubber covered to enhance shooter comfort during firing. In the forward part of the buttstock a hole is provided for insertion of the locking pin during disassembly.



Fig. 7 Folding the buttstock



Fig. 8 Unfolding the buttstock

Assembly Group 2 Bolt Group

The bolt group, together with the recoil spring assembly, is contained inside the upper receiver. The reciprocal movement of the bolt group provides for feeding and ignition of the cartridge, for extraction and ejection of the spent case as well as for cocking of the hammer. The right side of the bolt has a thumb recess for manual closing of the bolt (forward assist).

The recoil spring assembly pushes the bolt forward into the firing position. The cone-shaped support for the recoil spring assembly is housed in the backplate of the lower receiver. The longitudinally movable guide ring supports itself within the bolt.

DESCRIPTION OF ASSEMBLY GROUPS

The bolt group (Fig. 8 and 9) consists of:

- 1 bolt
- 2 firing pin spring
- 3 firing pin
- 4 extractor
- 5 firing pin retaining pin
- 6 recoil spring assembly, complete
- 6a guide ring
- 6b support

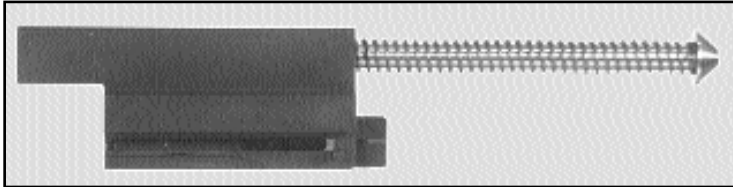

Fig. 8 Bolt Group, assembled

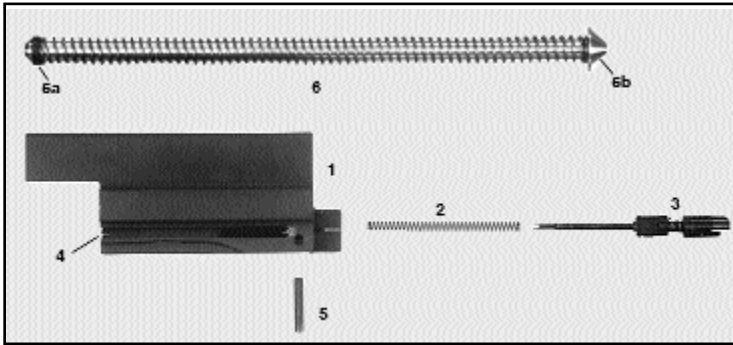
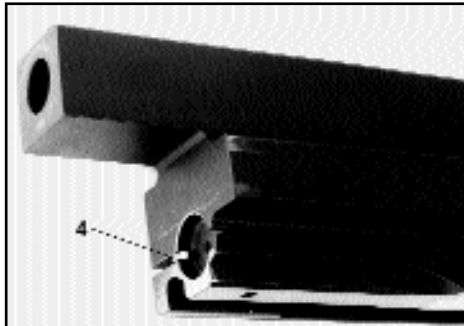

Fig. 9 Bolt Group, disassembled



UMP SUBMACHINE GUN

Assembly Group 3

Lower receiver with trigger mechanism

The lower receiver houses the trigger mechanism with safety/selector levers, the backplate, the magazine well, magazine release lever and bolt catch. The forward portion of the lower receiver is hooked to the upper receiver. The rear portion is fastened to the upper receiver using a removable locking pin.

The safety/selector levers are fitted on both sides of the pistol grip. The forward portion of the lower receiver has lugs for attachment to the upper receiver. Behind these lugs is the magazine well with the magazine release lever.

Above the magazine release lever is the bolt catch. It serves to hold the bolt rearward when the last round is fired and to release the bolt from the open position after an empty magazine has been replaced with a loaded magazine. The rear side of the lower receiver includes the integrated backplate with buffer and support for the recoil spring assembly.

The safety/selector lever of the "Navy" trigger mechanism has three positions :

Position  = Safe

Position  = Semi Automatic fire

Position  = Fully Automatic fire

Trigger Mechanism Variants

Trigger mechanism for single fire, 2-round burst and fully automatic fire.

The safety/selector lever has four positions :

Position  = Safe

Position  = Semi Automatic fire

Position  = 2-round burst

Position  = Fully automatic fire

NOTE: UMP trigger mechanisms with various combinations of the above firing modes and possibly others may also be available for the UMP Submachine gun.

DESCRIPTION OF ASSEMBLY GROUPS

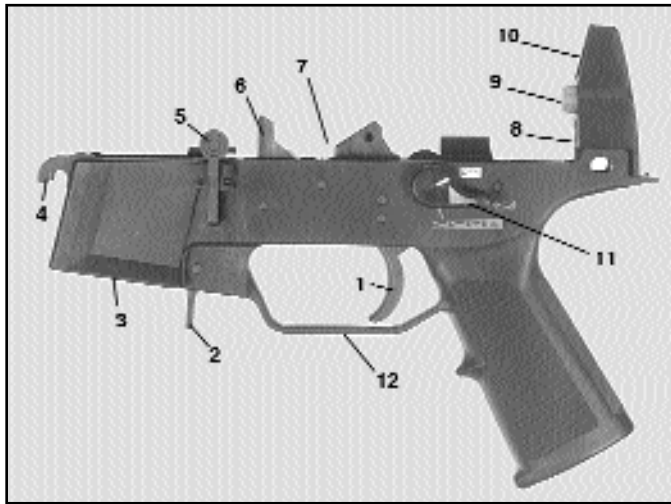

Fig. 10 Lower receiver with trigger mechanism, backplate and magazine well

- | | |
|--------------------------|------------------------------|
| 1 Trigger | 7 Trigger mechanism |
| 2 Magazine release lever | 8 Backplate |
| 3 Magazine well | 9 Buffer |
| 4 Attachment lugs | 10 Support for recoil spring |
| 5 Bolt catch | 11 Safety/Selector lever |
| 6 Release lever | 12 Trigger guard |



safe



semi-automatic fire



fully automatic fire

Fig. 11a, 11b, 11c Positions of the safety/selector lever for safe, single fire, and fully automatic fire



safe



semi-auto. fire



2-round burst



fully automatic fire

Fig. 11d, 11e, 11f, 11g Pistol grip with trigger mechanism for safe, single fire, 2-round burst, and fully automatic fire

UMP SUBMACHINE GUN

Assembly Group 4

Magazine

The magazine housing is constructed from plastic. The transparent panels on the magazine enables its contents to be checked visually.

The magazine consists of: magazine housing, magazine floor plate, follower, follower spring and locking plate.

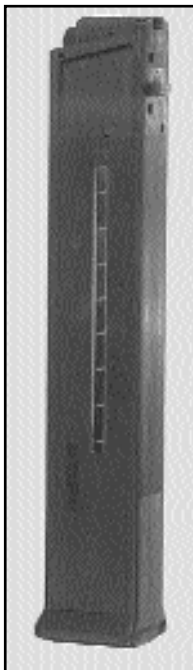

Fig. 12 Magazine, complete

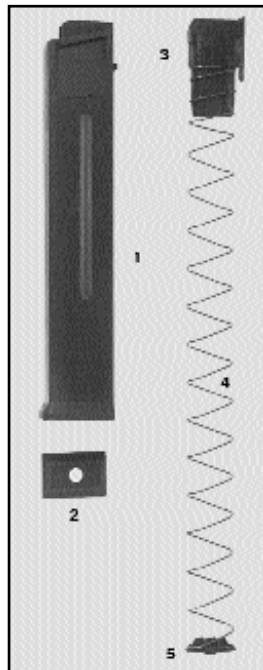

Fig. 13 Magazine, disassembled

- 1 Magazine housing
- 2 Magazine floor plate
- 3 Follower
- 4 Follower spring
- 5 Locking plate

Carrying sling

The carrying sling (Fig.14) enables the shooter to carry the UMP in any of several ways and ensures immediate readiness to fire from all carrying positions (see pages 43-44).

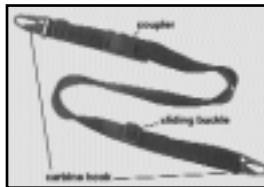
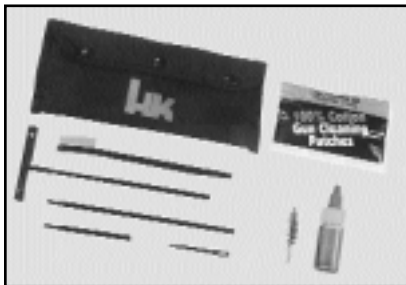

Fig. 14 Carrying sling



Cleaning Kit

The cleaning kit includes:

- | | |
|------------------------------------|----------------|
| 1 Transport case | 5 Oil bottle |
| 2 Cleaning patches | 6 Bore brush |
| 3 Cleaning brush | 7 Patch holder |
| 4 Cleaning rod with folding handle | |

Fig. 15 Cleaning Kit

Bruegger & Thomet

Quick Connect Sound Suppressor

To mount the suppressor, the locking lever is depressed, the suppressor is placed over the muzzle, and the locking lever released. Gas pressure at the muzzle is dissipated within the suppressor's chamber system. This considerably reduces muzzle blast.

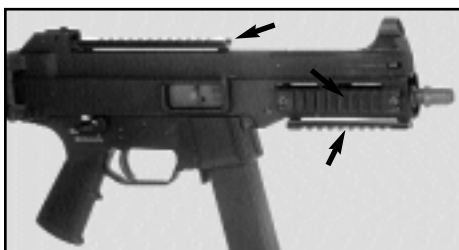

Mounting rails (MIL-STD-1913) for aiming devices

The mounting rail (Picatinny Rail) is screwed onto the molded-in hard points provided either on top of the receiver, below the forearm or on the right or left sides of the forearm.

Fig. 17 Mounting rails for aiming devices

Hand Stop

The hand stop prevents the shooter's hand from slipping over the muzzle. It is screwed to the lower mounting rail on the lower side of the forearm using a long screw or directly to the forearm support without a mounting rail with a short screw.

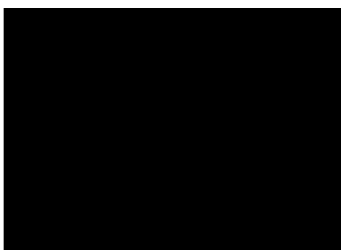

HANDLING & OPERATION OF THE UMP

Magazine Loader

The magazine loader aids in the filling of magazines.

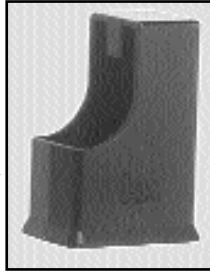

Fig. 19 Magazine Loader

Filling the Magazine

- Grasp magazine.
- Slide individual cartridges under the magazine lips one by one (Fig. 20).
- Repeat this process until the required number of cartridges has been inserted or the magazine is full.

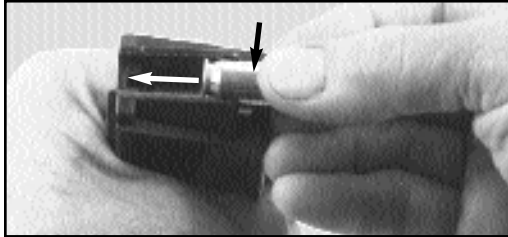

Fig. 20 Filling the magazine

NOTE: Loading more than the prescribed number or rounds (i.e. 25 cartridges in a 25-round magazine) will prevent the magazine from being inserted in the weapon with the bolt forward.

Filling the Magazine using the Magazine Loader

- Place the magazine loader onto the magazine, depress and hold.
- Slide individual cartridge (base first) under the magazine lips (Fig. 21).
- Release the magazine loader, fully seat the cartridge.
- Repeat this process until the required number of cartridges has been filled in.

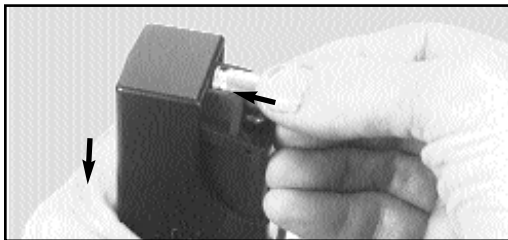

Fig. 20 Filling the magazine using a magazine loader

Emptying the Magazine

- Grasp magazine.
 - With your thumb, push cartridges forward out of the magazine into the palm of the other hand
- or
- Grasp magazine and hold it with the points of the bullets pointing towards the bottom.
 - Use a piece of wood to slide the cartridges out of the magazine.

Insertion and removal of magazine

- Put the UMP on  (Safe).
- Insert magazine into the magazine well (Fig. 22). The magazine catch has to engage audibly in the process. Tug on the magazine to ensure it is fully engaged.
- For removal of the magazine, push magazine catch forward (Fig.23) and remove magazine downward.



Fig. 22 Insert magazine

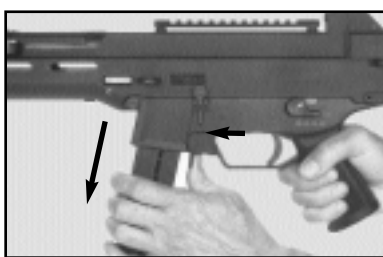



Fig. 23 Remove magazine

UMP SUBMACHINE GUN

Starting Situation 1: No magazine is present in the weapon. The bolt is forward.

- Put the UMP on  (Safe).
- Insert the loaded magazine into the magazine well until the magazine catch engages audibly. Tug downward to ensure it is properly seated.
- The UMP is partially loaded and with the safety on.
- Pull cocking lever backwards as far as it will go and let bolt snap back to its forward position. In the process do not ride the cocking lever forward.

or

- Pull cocking lever backwards as far as it will go, (Fig. 24) and swivel it upwards (engage it in the indent) into the open position.
- Insert the loaded magazine into the magazine well until the magazine catch engages audibly. Tug to check.
- With the open palm of the non-firing hand "slap" the cocking lever downward and forward to chamber a round. During this process do not ride the cocking lever forwards.

The UMP is now fully loaded and with the safety on.



Fig. 24 Pull cocking lever backwards

LOADING THE SUBMACHINE GUN

**Starting Situation 2: There is an empty magazine in the weapon.
The bolt is held back by the bolt catch.**

- Put the UMP on  (Safe).
- Push magazine catch forward and remove empty magazine.
- Insert the filled magazine into the magazine well until the magazine catch engages audibly. Tug to check.
- Depress upper end of bolt catch (Fig. 25), thus releasing the bolt and allowing it to snap forwards.
- The UMP is now fully loaded and with the safety on.

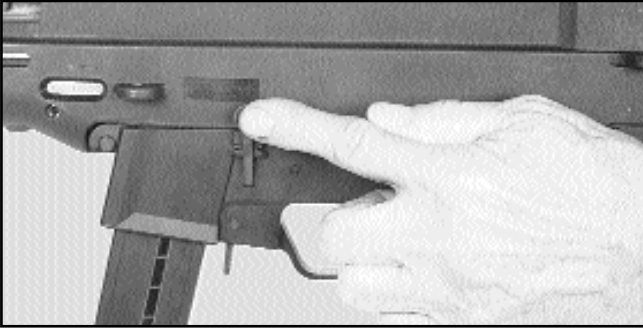

Fig. 25 Depress bolt catch to release the bolt

FORWARD ASSIST

With heavy external fouling of the UMP, (sand, sludge) or to load the weapon quietly, the thumb recess on the bolt may be used as a forward assist (Fig 25A). To do so use the thumb recess, push bolt forwards until it is in the forward most position.

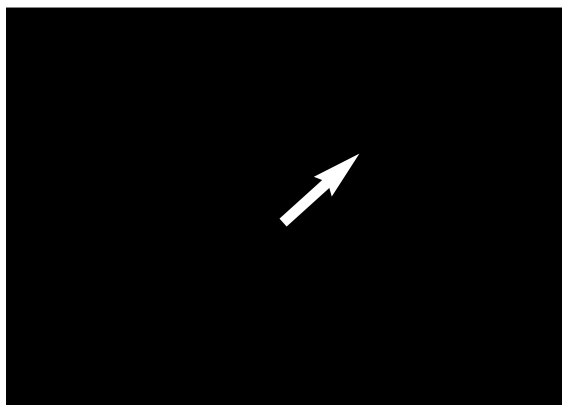

Fig. 25A Forward Assist

STORAGE OF THE WEAPON

1. Store the weapon clean and lubricated.
2. Store the weapon without a round in the chamber.
3. Store the weapon with the cocking lever forward and the hammer down (at rest).
4. After no more than twelve (12) months unload all loaded magazines and replace the ammunition with fresh ammunition.
5. Clean and lubricate the weapon and magazines every twelve (12) months while in storage.
6. Store the weapon in a clean, dry environment with regulated temperature controls.

UMP SUBMACHINE GUN

Disassembly of the UMP

NOTE: The UMP is disassembled and reassembled without the use of tools. The use of force is prohibited. The user of this weapon is not allowed to disassemble the weapon beyond that which is covered in this operators manual. Such disassembly may only be carried out by qualified maintenance personnel.

Safety check

- Put the UMP on "Safe".
- Remove the magazine.
- Pull cocking lever backwards as far as it will go and engage it in the indent in the cocking lever.
- Check to make sure the cartridge chamber is empty.
- Swivel cocking lever downward and allow the bolt to move forward.

Disassembly into assembly groups

- Detach carrying sling.
- Unfold buttstock.
- Pull out buttstock locking pin and store in the hole on the buttstock.
- Swivel lower receiver downward and detach (Fig. 26).



Fig. 26 Detaching lower receiver

CAUTION: When detaching the UMP lower receiver during disassembly, ensure the lower receiver does not rotate more than 80° around the axis where the attachment lugs hook on to the support bolts. Doing so will severely damage the attachment lugs.

- Fold buttstock.
- Pull back cocking lever and remove recoil spring assembly with bolt to the rear (Fig. 27).

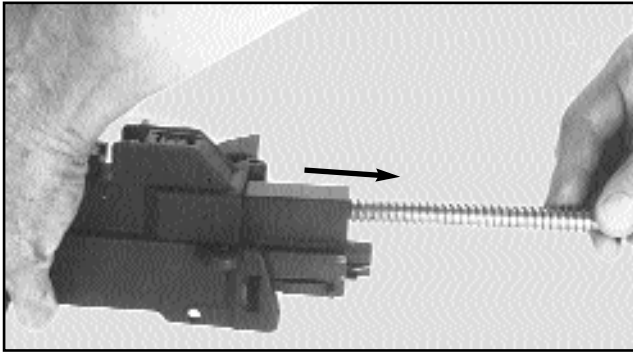

Fig. 27 Removing recoil spring assembly with bolt

UMP SUBMACHINE GUN

Disassembly of the Bolt

- Push and hold firing pin forward.
- Pull out firing pin retaining pin to the left (Fig. 28).
- Remove firing pin and firing pin spring to the rear. To do this, push locking catch to the right (Fig. 29). With your thumb prevent the firing pin with firing pin spring from springing out.

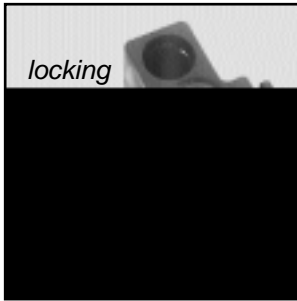

Fig. 28



Fig. 29

Pull out firing pin retaining pin Push locking catch to the right

WARNING: Never disassemble the firing pin. It is possible to assemble the firing pin assembly incorrectly and in doing so, disabling the UMP firing pin safety. Please contact HK for more information.

Assembly of the Bolt

- Place firing pin spring onto firing pin.
- Insert firing pin spring and firing pin into the bolt from the rear and push them forwards (Fig. 30).
- Using any pointed object push firing pin forwards (Fig. 31).
- Insert firing pin retaining pin from the left to retain firing pin in the bolt.

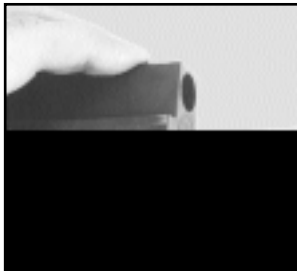

Fig. 30
*Insert firing pin spring
and firing pin*

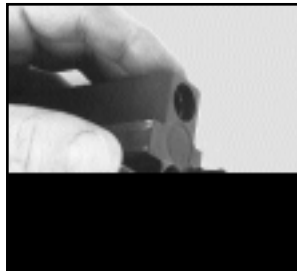

Fig. 31
Push firing pin forwards

Disassembly of the Magazine

- Depress locking plate through magazine floor plate and slide magazine floor plate to the rear.
- Detach magazine floor plate to the rear.
- Remove follower spring with locking plate and follower.

CAUTION: Magazine floor plate is under spring tension. With your thumb secure locking plate with follower spring to prevent it from springing out.

Assembly of Magazine

- Insert follower and follower spring with locking plate into the magazine housing from below.
- Fully depress follower spring and locking plate (Fig.29) and slide magazine floor plate onto magazine housing from the rear.
- Push magazine floor plate forwards as far as it will go.
- Check that the floorplate is fully seated and secured in place by the tab of the locking plate.

UMP SUBMACHINE GUN

Reassembly of the UMP

- Fold buttstock.
- Insert the bolt and recoil spring assembly to the receiver from the rear.
- Unfold buttstock.
- From below, engage lower receiver (hammer between cocked and released positions) into the support bolts on the upper receiver and swivel it upwards (Fig. 32).
- Insert locking pin into the upper receiver to secure lower receiver.
- Put the UMP on  (Safe).
- Insert empty magazine.
- Carry out a function check as described on page 30 (cock, check bolt catch function, set safety/selector lever on "Fire", pull trigger, set safety/selector lever to "Safe").
- Attach carrying sling (Fig. 33).

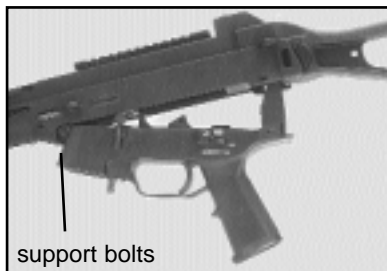

Fig. 32
Engage lower receiver



Fig. 33
Attaching carrying sling

FUNCTION CHECK

NOTE: A Function Check should be performed anytime the weapon is reassembled. This quick check indicates whether or not the weapon has been properly assembled and/or assembled with all components. A properly executed Function Check can also reveal many of the more obvious malfunctions that could occur between the interactive components of the weapon. ALWAYS clear the weapon before performing the Function Check! ENSURE the weapon is clear!

1. Clear the weapon.
2. Place the cocking lever and bolt group in the forward position.
3. With the weapon on "Safe", pull the trigger. Hammer should not fall.
4. Place the weapon on "Semi-automatic". Pull the trigger and hold the trigger back. Hammer should fall.
5. Still holding the trigger back, recock the weapon. Release the trigger. Listen for the "click" of the trigger and sear resetting. Pull the trigger. Hammer should fall.
6. Place the weapon on "Burst", if applicable. Recock the weapon. Pull the trigger and hold the trigger back. Hammer should fall.
7. Still holding the trigger back, recock the weapon. Release the trigger. You should not hear the hammer fall. (The hammer should already be forward).
8. Place the weapon on "Fully-automatic", if applicable. Recock the weapon. Pull the trigger and hold the trigger back. Hammer should fall.
9. Still holding the trigger back, recock the weapon. Release the trigger. You should not hear the hammer fall. (Again, the hammer should already be forward).

The Function Check is now complete.

UMP SUBMACHINE GUN

Operator Cleaning

- The functional performance of any mechanical device varies greatly on the quality and frequency of the maintenance performed on that item. Firearms are no exception. The operator spends most of the time with the weapon and therefore has the best opportunity to perform the necessary upkeep required to insure top performance at all times.
- Metal components of new UMPs are coated in a thick, oily preservative that should be removed prior to the weapon being used or fired. This preservative oil, applied by HK personnel prior to the shipment of the weapons from the manufacturing facility in Germany, guarantees that the weapons and accessories will remain corrosion-free during storage and transport. However, this preservative fluid is not considered a lubricant and therefore should be removed and replaced with a high-quality weapons lubricant whenever possible. This preservative fluid attracts debris and dirt and possesses little or no lubrication qualities.
- Cleaning the UMP, especially with its polymer construction, need not take hours and a great deal of effort. With the right equipment a very fouled UMP should be able to be thoroughly cleaned in less than 10 minutes. A solvent tank where the parts can be immersed in and scrubbed will save a great deal of time and effort as will compressed air to blow off the fouling and solvent or to spread the lubricant. There are companies, such as **Safety-Kleen**, that sell or rent such solvent tanks and will exchange the solvent on a regular basis at a reasonable price.

NOTE: If using Ultra Sonic-type cleaning machines, do not immerse the painted portion of the UMP, specifically the color pictogram firing mode markings on the lower receiver. Ultra sonic cleaning will remove the markings!

- If such a set up is not available to you, a complete weapons cleaning kit specially designed for the HK UMP will reduce your cleaning time and make the job easier.
- Any quality weapons solvent or oil can be used to clean the UMP. Basically, if it's safe to put your bare hands into it won't hurt the surfaces of the weapon. **Break-Free (CLP)**, **Ballistol**, **Militec** or any of the other brand-name cleaners or lubricants specifically designed for use with weapons will work well on the UMP.
- At HK we recommend two types of operator cleaning. Normal cleaning and Major cleaning.

Normal cleaning

Performed after each firing or every twelve (12) months.

Major cleaning

Often referred to as “detailed cleaning”. Performed on an unsuppressed UMP after 1,000 rounds (500 for a suppressed UMP) or when the weapon is exposed to or excessively laden with sand, dust, water or other visible contaminants or foreign matter.

- The cleaning intervals listed here are recommendations only!
- Your intervals between cleaning will vary greatly depending on many factors to include the type of ammunition used, the environment in which the weapon is used, and the thoroughness of your cleaning, etc.

Normal Cleaning

1. CLEAR THE WEAPON!

2. Disassemble the weapon into the major assembly groups.

Bruegger & Thomet Quick Connect Sound Suppressor Use a nylon bristle toothbrush and rag or swab to remove all fouling from the attachment area and locking lever of the sound suppressor. Tap the sound suppressor lightly on a padded surface or blow it out with compressed air to remove any loose fouling from inside the suppressor body. (DO NOT immerse the sound suppressor in solvent or insert any rods, brushes or patches into the sound suppressor body! Wipe the outside of the sound suppressor off with a clean, oil-free rag. Do not apply oil to the outside of the sound suppressor or it will burn off during firing and obscure the operators view of the target.

Multi-purpose carrying sling The nylon webbing and plastic components of the multi-purpose carrying sling can be cleaned using warm soap, water, and a soft bristled brush. Allow the sling material to dry completely before storage or use.

Buttstock Simply remove any foreign debris from the exterior polymer and rubber surface of the buttstock using a toothbrush, rag, swabs or compressed air when available.

Lower receiver Remove any foreign debris from the plastic pistol grip using a tooth-brush, rag, swabs or compressed air. Scrub the top of the hammer, ejector and the area around the front of the ejector and release lever with a small amount of solvent or oil to break up the carbon fouling. Remove the loose fouling and debris by rinsing the components in the a solvent tank or by using rags, swabs, or

UMP SUBMACHINE GUN

compressed air.

Forearm / foregrip Remove any foreign debris from the forearm or optional foregrip using a toothbrush, rag or compressed air.

Upper receiver with barrel Start with the bore and chamber.

- **Bore** – Apply a liberal amount of solvent to a bronze bristle bore brush of the appropriate caliber. Always insert the bore brush from the chamber end and push it all the way through the barrel in the direction that the bullet travels. Pull the brush back through the barrel. **DO NOT** allow the brush to stop in the bore or it may get stuck! Repeat this in/out procedure for a minimum of three complete trips. Remove the bore brush and let the solvent work in the bore for a few minutes while you clean other components.
- **Chamber** – Apply a liberal amount of solvent to the appropriate bore brush. Insert the brush through the back of the receiver into the chamber. **DO NOT** push the brush past the chamber! Work the brush back and forth in the chamber at least three times. Remove the brush and let the solvent go to work on the fouling for a few minutes while you work on other components.
- **Chamber face** – This area is easily tackled using the special Chamber Face brush available in the HK Field Weapons Cleaning Kit for the UMP submachine gun. Attach this brush to the cleaning rod and lock the handle so that the rod and brush can be turned together. Apply a liberal amount of solvent to the bristles of the brush. Insert the brush through the back of the receiver until it makes contact with the area surrounding the opening to the chamber and bore. With slight inward pressure, rotate the brush in a clockwise direction to break up the carbon fouling built-up on the face of the chamber. Continue this procedure until you are satisfied with your efforts.
- **Upper Receiver** – Apply a few drops of solvent to a toothbrush and scrub the area around the chamber face and along the length of the receiver rails to break-up the carbon fouling.
- **Muzzle and accessory attachment interface** – Use a nylon bristle toothbrush and a small amount of solvent to remove any fouling from the muzzle where the sound suppressor and muzzle mounted accessories attach. Remove all of the fouling, carbon, and visible debris from the entire upper receiver using a solvent tank and compressed air or swabs, patches, rags, etc. Run at least three clean patches of the appropriate size all the way through the bore in the direction of bullet travel to remove the loose fouling and solvent.

Bolt group

Scrub all parts of the bolt group with a toothbrush and solvent where carbon is visible, especially around the face of the bolt and the extractor. **Do not attempt to remove the extractor for cleaning!** There is no functional need to remove the extractor for normal cleaning. Remove the loose fouling from all parts using a rag, swabs or compressed air.

Magazine Don't forget the magazines! They are very important and very often overlooked during cleaning. Many stoppages occur as a result of improperly maintained magazines.

Apply a few drops of solvent to a toothbrush and scrub the top of the magazine to remove any visible carbon fouling or loose debris. Pay special attention to the front edge of the housing, feed lips, and the follower.

Remove the solvent and loose fouling from the magazine using a rag, swabs or compressed air.

Major Cleaning

As mentioned earlier, Major cleaning should be performed after 1,000 rounds are fired through an unsuppressed UMP or 500 rounds through a suppressed UMP. Major cleaning is also performed when the weapon has been immersed in water or is laden with large amounts of visible foreign matter or fouling.

During Major cleaning, all weapon components except the sound suppressor and the carrying sling, should be rinsed with or immersed in solvent and scrubbed thoroughly with a brush. This includes the magazine and its parts. The components can then be dried using a rag or swabs, though compressed air is preferable for Major cleaning.

If any assembly groups require a more thorough cleaning, an "Ultra-Sonic" cleaning machine can be used containing any solvent that it is safe to place your bare hands in, as a general rule.

However, avoid placing painted surfaces such as the firing mode markings on the lower receiver into an ultra-sonic cleaner, as this may remove the colored markings. Further disassembly of any assembly group(s) beyond the level described above **must** be performed by, or at a minimum supervised by, an HK factory-trained armorer.

Operator inspection

During or after cleaning the operator should inspect the weapon and its components for any irregularities that may cause problems during its operation. If any potential deficiencies are noted, they should be corrected immediately and/or brought to the attention of the unit armorer. In general, the operator should keep a watchful eye out for the following discrepancies both in the weapon as a whole and in each assembly group.

- Improper function
- Missing parts
- Cosmetic flaws (cracks, dents, burrs, rust, etc.)
- Improper assembly
- Loss of spring tension (where applicable)
- Unusual looseness (where applicable)
- Cracked welds
- Excessive wear
- Absence of protective finish (where applicable)
- Absence of proper lubrication

Also check these more areas where problems may begin in the UMP.

Lubrication

Any type of high-quality, medium-weight lubricant (oil) specifically designed for use on firearms such as **Break-Free (C.L.P.) Ballistol**, or **Militec** will work well on the HK UMP submachine gun. **DO NOT** use lubricants/cleaners that boast of their ability to penetrate metal (i.e. **WD-40, Tri-Flow**, etc.) as these substances may deaden primers.

Where and how much?

No Lube – (surface is dry and not slippery to the touch)

- Sound suppressor body
- Sling
- Plastic components

Light Lube – (finger run across surface yields little or no lube)

- Bore and chamber
- All metal parts (except sound suppressor)
- Muzzle
- Magazine spring
- Axles of all operating controls (cocking lever, bolt catch, safety/selector lever, magazine catch, etc.)
- Rear sight assembly

LUBRICATION

- All metal accessories

Medium Lube – (finger run across surface yields some lube but lube does not run down surface when held in a vertical position)

- Bolt group with recoil spring and guide rod

Heavy Lube – (Lube runs down surface when held in a vertical position) *No heavy lube is required on the HK UMP!*

- Reapply lubrication to the bolt of the UMP periodically during firing as it burns off from the heat. Sound suppressed weapons generate more smoke and noxious gases especially when over lubricated.
- Apply lubricant using a shaving brush, swabs, patches, or rag. A spray bottle also works well using compressed air to circulate the lubricant into all parts and to remove the excess.

Special use and maintenance of HK sound suppressed weapons

In addition to the basic maintenance instructions provided earlier, sound suppressed weapons require additional special attention from the operator. Consult the instructions received from the manufacturer with the sound suppressor for additional guidance.

All weapons with sound suppressors require more cleaning than the same type of weapon without a sound suppressor. This is because the sound suppressor is designed to capture or “suppress” the expanding propellant gases that exit the muzzle of the weapon behind the projectile. These gases exit the weapon at a supersonic velocity causing a “muzzle blast”. The sound suppressor captures these propellant gases, contains them within a series of baffles or chambers and allows them to escape at a slower velocity thus eliminating the muzzle blast.

At the same time that the gases are contained, so is the carbon fouling and propellant debris that would normally be blown out of an unsuppressed weapon with the propellant gases. More fouling and debris stays behind in a sound suppressed weapon and thus there is more for the operator to remove during his cleaning.

In order to be effective, a sound suppressed weapon must also provide some means to reduce or eliminate the supersonic “crack” of the projectile as it leaves the muzzle at a supersonic velocity (above 1,088 feet/second at sea level).

This can be accomplished in two ways. One. By venting gases from

UMP SUBMACHINE GUN

behind the projectile as it passes through the bore and sound suppressor thus lowering the exit velocity of the bullet below 1,088 feet/second. Or two, by firing ammunition in the weapon that is down-loaded to a velocity below the supersonic range. This is the method used in the HK UMP submachine gun. For this reason this ammunition is termed "subsonic" and usually falls into the range between 875 – 1,050 feet/second. Both methods are effective but each has it's own disadvantages and advantages.

There are two different styles of sound suppressors available for use on the UMP submachine gun, a quick connect aluminum or stainless steel sound suppressor.

Both versions are of the "wipeless" design, meaning they have no rubber or synthetic membranes (wipes) that the bullet must penetrate. The projectile does not touch any portion of the wipeless sound suppressor. Wipeless designs are far more durable than other designs and generally give the best accuracy results.

UMP with quick connect sound suppressor

- The HK UMP submachine guns are designed to be fired using supersonic or subsonic ammunition with any weight projectile and with or without the sound suppressor attached.
- The Aluminum **Bruegger & Thomet Quick Connect** UMP .45 caliber sound suppressor is 6.70 inches long and weighs .99 pounds. It is intended to be used with subsonic ammunition for maximum sound suppression. ***The UMP does not have a vented barrel as is found on the HK MP5SD*** and therefore does not lower the velocity of the ammunition fired in it. These quick connect sound suppressors can be used with supersonic ammunition but the supersonic "crack" of the projectile will still remain even though the sound suppressor does eliminate the "muzzle blast" caused by the propellant gases. Other sound suppressors are available for use on the UMP, contact HK for additional guidance.
- Accuracy from the quick attach sound suppressor is excellent, often better than the weapon without the sound suppressor attached, though there is sometimes a slight change in zero when the sound suppressor is attached. This is mostly due to the longer distance that the projectile must pass through (similar to firing through a longer barrel) on it's way to the target.
- Effectiveness and service life of sound suppressors varies greatly due to countless variables. Some of these variables include the type and quantity of ammunition used, the predominant mode of fire used, the operational environment in which the weapons are employed, etc.

SOUND SUPPRESSOR

Generally, the aluminum **Bruegger & Thomet** UMP sound suppressors when used with the recommended ammunition provide 20–25 decibels (dBA) sound reduction when compared to an unsuppressed weapon.

- An aluminum sound suppressor will generally maintain its effectiveness to 20,000 rounds; stainless steel suppressors to 40,000 rounds or more.
- Older sound suppressors can be replaced by the operator for a reasonable cost. Many teams will keep the older sound suppressor for training and maintain the newer one for operational use where peak performance is desired.

Observe the following recommendations

- DO NOT attempt to open the sealed sound suppressor body
- DO NOT allow the sound suppressor to loosen during use.
- DO NOT use any form of tool or wrench to install or remove the sound suppressor.
- Always tug forward on the UMP sound suppressor after mounting to ensure that it is properly attached.
- If the sound suppressor will not detach from the weapon, consult the section entitled “Normal Cleaning” of the sound suppressor or call Heckler & Koch for guidance.
- DO NOT fire the UMP with the aluminum sound suppressor full of water. Allow the water to drain from the sound suppressor before attempting to fire the weapon.
- DO NOT attempt to fire the weapon if the sound suppressor has been dented or damaged or there is damage around the exit hole or if the sound suppressor fits loosely on the weapon.
- DO NOT insert anything into the body of the sound suppressor such as a cleaning rod or brush.
- DO NOT add to or fire the weapon with oil, grease or any foreign matter inside unless directed to by the manufacturer of the specific sound suppressor.
- Keep the muzzle and attachment interface for the sound suppressors and muzzle mounted accessories as clean as possible at all times to insure that the sound suppressor and accessories can be easily attached and detached when required. Clean the muzzle with a nylon toothbrush or patch soaked in oil or solvent during each cleaning. Lightly lube the muzzle once it is clean. A dirty muzzle can make it very difficult to attach and detach the sound suppressor.

UMP SUBMACHINE GUN

Ammunition

The UMP submachine gun was designed to use ammunition designed to NATO or SAAMI specifications. Like an automobile engine, you cannot expect top performance by using poor quality fuel. The same applies to firearms. There are a number of general considerations that should be made when choosing the type of ammunition you plan to use in the UMP.

DO USE

- Ammunition of the appropriate caliber and of recent manufacture
- Clean burning ammunition
- Non-corrosive ammunition
- Jacketed Hollow Point (JHP), "Silver-Tip", ball, truncated cone, "Hydra Shok", +P, etc.
- Limited quantities of .45 Super ammunition in the UMP45 model

DO NOT USE

- Reloads or remanufactured ammunition. Beware of military surplus, foreign or outdated ammunition.
- Non-jacketed or exposed lead ammunition
- Corrosive ammunition (primer and/or propellant)
- Any ammunition that exceeds NATO or S.A.A.M.I. pressure limits
- Empty cases as "dummy" (inert) rounds, as damage may result to the weapon, especially the synthetic magazines employed in the UMP. Use complete dummy rounds available for training purposes.
- Aluminum cased ammunition (i.e. CCI Blazer) in the UMP40.

Stoppages

In the event of stoppages on the UMP, the weapon is to be considered loaded until the actual cause of the stoppage has been determined. During the elimination of stoppages, safety precautions are to be taken into account.

In the event of stoppages on the UMP, for example the cartridge fired from the UMP is not ignited, the bolt assembly does not close completely, or the spent cartridge case is not ejected, the following immediate steps have to be taken:

1. Put the UMP on  (Safe).
2. Remove the magazine.
3. Unload the UMP.
4. Ensure that barrel, cartridge chamber and receiver are free of obstructions.

TROUBLESHOOTING

5. Next, determine and eliminate the cause of the stoppage. The items indicated in the following tables do not cover all stoppages theoretically possible. A given stoppage may also have been caused by other reasons than the ones indicated.

Stoppage	Cause	Remedy
Cartridge not ignited	Ammunition fault (Dud round)	Recock UMP
	Firing pin damaged or broken	Take UMP to maintenance shop
	Hammer spring damaged or broken	Take UMP to maintenance shop
Bolt did not stay open on the last shot	Cartridge case stuck in chamber because it is deformed or the chamber is dirty	Unload. Retract bolt to eject spent case. Clean if fouled. If required take UMP to maintenance shop
Cartridge case not extracted or ejected	Chamber is dirty.	Clean cartridge chamber.
	Extractor broken.	Take UMP to maintenance shop
	Ejector damaged	Take UMP to maintenance shop
	Insufficient bolt recoil	Unload. Retract load via cocking lever to eject spent case. Check for smooth movement of bolt and check chamber for fouling. Clean if required.

UMP SUBMACHINE GUN

Stoppage	Cause	Remedy
No cartridge fed by bolt.	Magazine not properly inserted.	Insert magazine properly.
	Magazine loose	Check magazine catch and notch on magazine. If required take UMP to maintenance shop.
	Follower spring lame	Replace magazine or follower spring and take to maintenance shop.
	Magazine lips damaged	Replace magazine or magazine housing and take the damaged one to maintenance shop
Bolt not fully closed. Cartridge not fully fed.	Cartridge chamber dirty	Clean cartridge chamber.
	Cartridge damaged	Recock
	Recoil spring lame	Take UMP to maintenance shop
	Improperly cocked	Allow cocking lever to snap forward. On releasing cocking lever do not ride it forward.
Bolt does not stay open after last shot	Magazine spring lame.	Replace magazine and take damaged one to the maintenance shop
	Catch damaged	Take UMP to maintenance shop.
Magazine stuck in magazine well	Magazine damaged	Replace magazine spring and take damaged one to the maintenance shop
	Magazine catch defective	Take UMP to maintenance shop.

Carrying sling

The carrying sling enables the UMP to be carried in several ways. In this process, the buttstock may be folded up or unfolded.

The carrying sling is attached to the mounting points on the receiver, handstop, or buttstock via the carbine hooks.

Length Adjustment

- Close coupler
- Rest the carrying sling between thumb and index finger and let the UMP hang down in a horizontal position. Adjust the length in such a way that there is a space of approximately 10 cm (4 inches) between your forearm and the UMP (Fig. 34).

For adjustment

- Slide the forward buckle and coupler with the sewn-up end as far as possible up to the front carbine.
- Somewhat loosen the belt loop in the rear buckle.
- To shorten the carrying sling, pull the upper loop forwards
- To lengthen the carrying sling, pull the upper loop to the rear.
- Tighten loop in the buckle
- Tighten carrying sling

Routing the Carrying sling

In order to carry the UMP laterally against the body or in front of the body (ready position), or on the back, the carrying sling must be properly routed. To do so:

- Pull the two halves of the carrying sling apart and upwards.
- Place the upper part of the carrying sling onto your shoulder over your head.

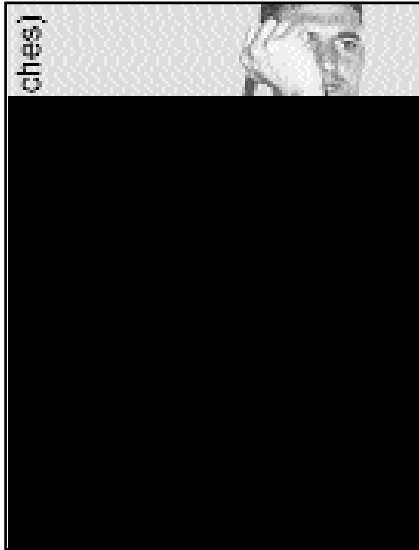

Fig. 34 Length adjustment

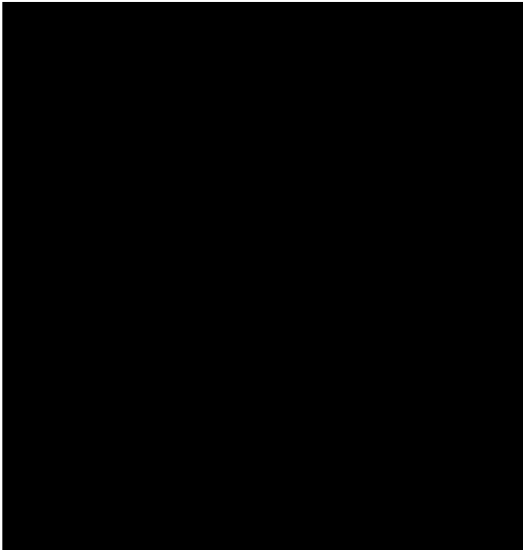

Fig. 35 Place upper half onto shoulder over the head

Carrying modes

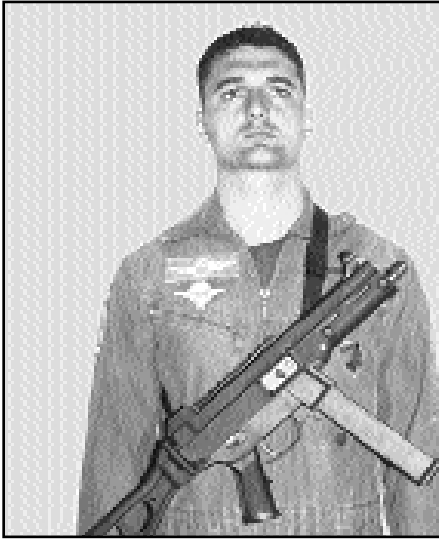

Fig. 36 UMP across the chest



Fig. 37 UMP on the back

UMP SUBMACHINE GUN

Firing positions

Fig. 38 UMP fired from the shoulder



Fig. 39 UMP fired from the hip



SIGHT ALIGNMENT FOR THE UMP

Sight Adjustment

If the point of impact has to be corrected, this will be done by adjustment of the rear sight using the Allen wrench provided with the weapon. The UMP is zeroed at the factory to hit the point of aim at 25 meters (27.3 yards).

Elevation adjustment

- To lower the weapon's point of impact, turn the elevation adjustment screw clockwise.
- To raise the weapon's point of impact, turn the elevation adjustment screw counterclockwise.

NOTE: 1 revolution of the elevation adjustment screw changes the point of impact by 4.5 centimeters (1.77 inches) at a range of 25 meters (27.3 yards).

Windage adjustment

- To move the weapon's point of impact to the left, turn the windage adjustment screw counterclockwise.
- To move the weapon's point of impact to the right, turn the windage adjustment screw clockwise.

NOTE: 1 click of the windage adjustment screw changes the point of impact by 1.15 centimeters (.45 inches) at a range of 25 meters (27.3 yards).

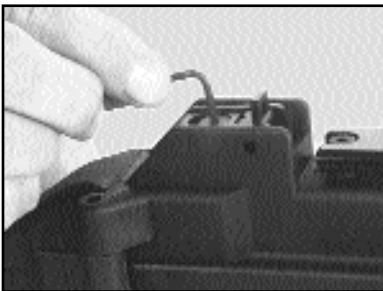

Fig. 40 Elevation adjustment

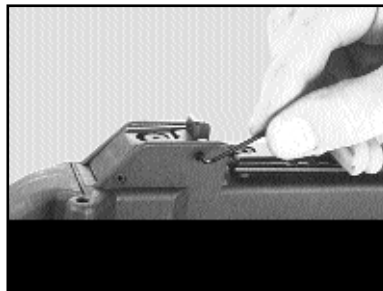
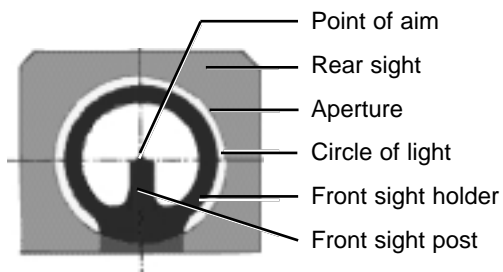

Fig. 41 Windage adjustment

Sight alignment for UMP

Correct point of aim
Even circle of light



Impact as with incorrectly centered front sight = left

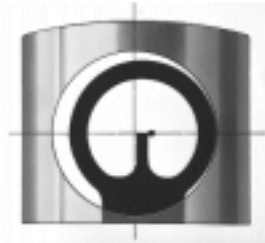

Impact as with incorrectly centered front sight = right



Impact as with full sight = high



Impact as with fine sight = low

Fig. 42 Sight pictures

SPECIFICATIONS

Specifications UMP45

Caliber45 ACP
Operating principle Simple blow back, firing from a closed bolt position

Dimensions

Overall length, buttstock extended 690 mm (27.17 in)
Overall length, with sound suppressor, buttstock extended 860 mm (33.86 in)
Overall length, buttstock folded 450 mm (17.72 in)
Overall length, with sound suppressor, buttstock folded 620 mm (24.41 in)
Overall width 63.5 mm (2.50 in)
Overall height with magazine 326 mm (12.83 in)
Barrel length 200 mm (7.87 in)
Twist length 406 mm (15.98 in)
Sight radius 325 mm (12.80 in)

Weights

UMP without magazine approximately 2.26 kg (4.93 lb.)
Magazine, empty (25 rounds) 0.17 kg (.38 lb.)
Carrying sling 0.10 kg (.22 lb.)
Sound suppressor (B&T) 0.38 kg (.84 lb.)

Other Data

Muzzle velocity (M1911) approximately 260 m/s (853 fps)
Muzzle velocity (+P) approximately 380 m/s (1,247 fps)
Cyclic rate of fire approximately 600 rpm (M1911)
..... approximately 700 rpm (+ P)
Firing modes Semi-automatic, 2-round burst, fully automatic
Sights Modular approach,
Standard adjustable mechanical sight,
Accessory mounting rails for optional aiming devices
Bore profile 6x polygonal, right-hand twist

Specifications UMP40

Caliber40 S&W
Operating principle Simple blow back, firing from a closed bolt position

Dimensions

Overall length, buttstock extended 690 mm (27.17 in)
Overall length, with sound suppressor, buttstock extended 860 mm (33.86 in)
Overall length, buttstock folded 450 mm (17.72 in)
Overall length, with sound suppressor, buttstock folded 620 mm (24.41 in)
Overall width 63.5 mm (2.50 in)
Overall height with magazine 303 mm (11.93 in)
Barrel length 200 mm (7.87 in)
Twist length 377 mm (14.84 in)
Sight radius 325 mm (12.80 in)

Weights

UMP without magazine approximately 2.1 kg (4.63 lb.)
Magazine, empty (30 rounds) 0.17 kg (.38 lb.)
Carrying sling 0.10 kg (.22 lb.)
Sound suppressor (B&T) 0.38 kg (.84 lb.)

Other Data

Muzzle velocity (Winchester 180 grain JHP) approximately 358 m/s (1174 fps)
Muzzle velocity (Corbon 150 grain JHP +P) approximately 384 m/s (1260 fps)
Cyclic rate of fire approximately 745 rpm
Firing modes Semi-automatic, 2-round burst, fully automatic
Sights Modular approach,
Standard adjustable mechanical sight,
Accessory mounting rails for optional aiming devices
Bore profile 6x polygonal, right-hand twist

UMP SUBMACHINE GUN

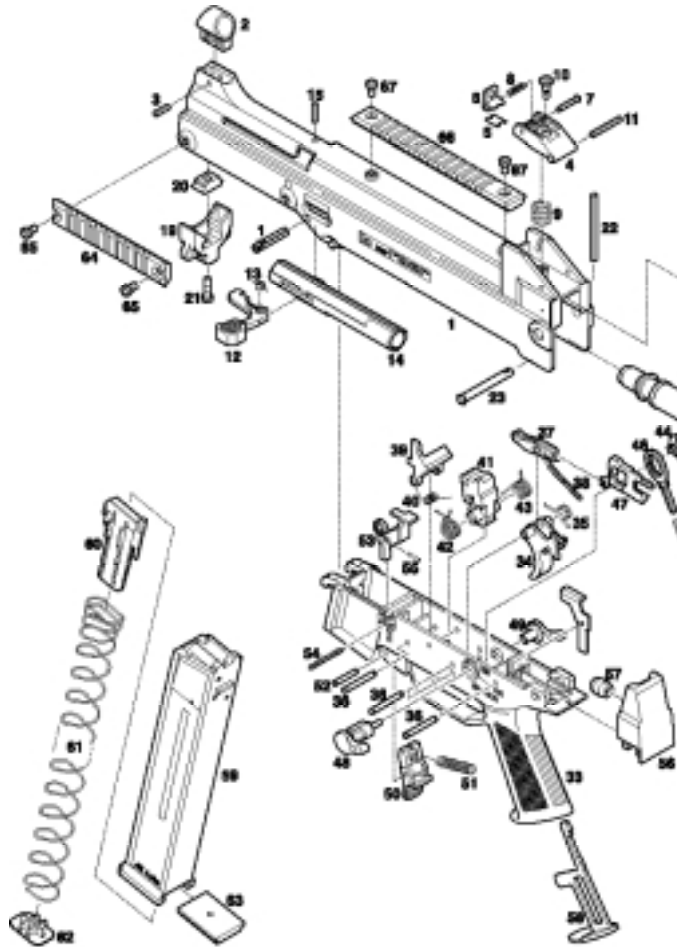

Item	Description	Part No.	Item	Description	Part No.
	Upper receiver with barrel,complete (1 - 21)	217503	20	Insert plate, handstop	219343
1	Upper receiver, incomplete	217509	21	Cylindrical screw, handstop 5 x16 mm	219414
2	Front sight	217506	22	Axle, buttstock	219401
3	Roll pin, front sight, 4x 144 mm	928747	23	Butt stock, complete (24- 25)	217558
4	Rear sight, complete. (4 - 10)	217513	23	Locking pin, complete.	217197
5	Sight support	217992	24	Buttstock, incomplete	217559
6	Flat spring	217515	25	Buttstock lock	205454
7	Rear sight	217516	26	Spring for buttstock lock	205455
8	Windage adjustment screw	217517		Bolt, complete .45 ACP (27 - 31)	217572
9	Rear sight spring	217518		Bolt, complete .40 S&W (27 - 31)	217562
10	Sight support spring	217504	27	Bolt , incomplete, .45 ACP	217574
11	Elevation adjustment screw	217505	27	Bolt , complete, .40 S&W	217564
12	Roll pin, sight support	987695	28	Extractor .45 ACP	217573
13	Cocking lever	217519		Extractor .40 S&W	217231
14	Cocking lever spring	217508	29	Firing pin assembly, complete	217555
15	Cocking lever support	217507	30	Firing pin spring	217523
16	Roll pin, cocking lever support	986546	31	Firing pin retaining pin	217587
17	Barrel, .45 ACP	219403	32	Recoil spring assembly, complete	217548
18	Barrel, .40 S&W	219402		Pistol grip, complete. (33 - 58)	217531
19	Roll pin, barrel, 6 x 32mm	988425	33	Pistol grip, incomplete	217546
	Ejector	219399	34	Trigger	205420
	Hand stop, complete. (19-21)	219364	35	Trigger spring	205422
	Hand stop, incomplete	219342	36	Axle (3x)	217532

EXPLODED DIAGRAM & PARTS LIST

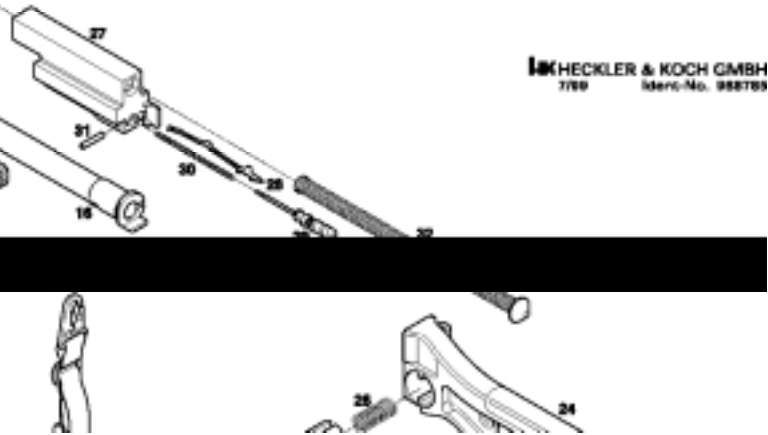

HECKLER & KOCH GMBH
 7189 Ident.-No. 988789

Part No.

38	Sear spring	205421	59	Magazine housing, .45 ACP	217766
39	Release lever	217535		Magazine housing, .40 S&W	217581
40	Release lever spring	217534	60	Follower .45 ACP	217767
41	Hammer	217545		Follower .40 S&W	217577
42	Hammer spring, left	217533	61	Magazine spring .45 ACP	217769
43	Hammer spring, right	217585		Magazine spring .40 S&W	217578
44	Notched disk	205417	62	Locking plate .45 ACP	217799
45	Compression spring	205418		Locking plate .40 S&W	217579
46	Index plate	205419	63	Floor plate	217770
47	Slide	214608		Picatinny rail, short, complete with screws	217580
48	Safety lever, left	217753	64	Picatinny rail, short	219362
49	Safety lever, right	214607	65	Cylindrical screw (2x)	219660
50	Magazine release	217537	66	Picatinny rail, long, complete. (66 - 67)	219413
51	Magazine release spring	217536	67	Picatinny rail, long	219363
52	Magazine release axle	217538	68	Cylindrical screw (2x)	219661
53	Bolt catch	217540	69	Sound suppressor, complete .45 ACP *	219413
54	Bolt catch spring	217539		Sound suppressor, complete .40 S&W *	217831
55	Roll pin, bolt catch	928080	70	Carrying sling, UMP complete.	217831
56	Backplate	217541		Magazine loader *	219085
57	Buffer	217544			219404
58	Pistol grip cover	205438			
	Magazine complete .45 (59 - 63)	217576	*	not pictured	