

Operating Instructions

Multi-Format Monitor
Model **BT-H1700BP**

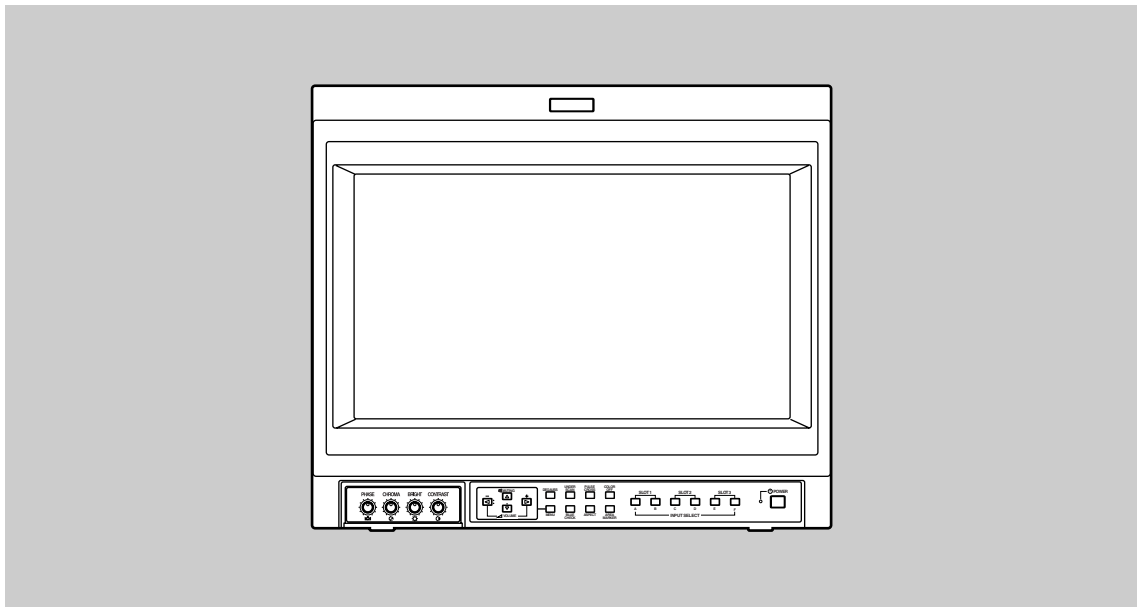

Panasonic

Before attempting to connect, operate or adjust this product, please read these instructions completely.

Printed in Japan
VQT0G67-1

LCT1464-001B
1003-MK-MW-VP



SAFETY PRECAUTIONS

In order to prevent any fatal accidents caused by misoperation or mishandling the monitor, be fully aware of all the following precautions.

WARNINGS

To prevent fire or shock hazard, do not expose this monitor to rain or moisture. Dangerous high voltages are present inside the unit. Do not remove the back cover of the cabinet. When servicing the monitor, consult qualified service personnel. Never try to service it yourself.

WARNING : THIS APPARATUS MUST BE EARTHED.

Improper operations, in particular alternation of high voltage or changing the type of tube may result in x-ray emission of considerable dose. A unit altered in such a way no longer meets the standards of certification, and must therefore no longer be operated.

This monitor is equipped with a 3-blade grounding-type plug to satisfy FCC rule. If you are unable to insert the plug into the outlet, contact your electrician.

FCC INFORMATION (U.S.A. only)

CAUTION: Changes or modification not approved by PANASONIC could void the user's authority to operate the equipment.

NOTE: This equipment has been tested and found to comply with the limits for a Class A digital device, pursuant to Part 15 of the FCC Rules. These limits are designed to provide reasonable protection against harmful interference when the equipment is operated in a commercial environment. This equipment generates, uses, and can radiate radio frequency energy and, if not installed and used in accordance with the instruction manual, may cause harmful interference to radio communications. Operation of this equipment in a residential area is likely to cause harmful interference in which case the user will be required to correct the interference at his own expense.

Notice (U.S.A. only)

This product utilizes both a Cathode Ray Tube (CRT) and other components that contain lead. Disposal of these materials may be regulated in your community due to environmental considerations. For disposal or recycling information please contact your local authorities, or the Electronics Industries Alliance: <<http://www.eiae.org>>

■ PRECAUTIONS

- Use only the power source specified on the unit. (120 V AC, 50 Hz/60 Hz)
- Keep flammable material, water, and metal objects away from the unit – especially the interior of the unit.
- This unit incorporates high voltage circuitry. For your own safety and that of your equipment, do not attempt to modify or disassemble this monitor. There are no user-serviceable parts inside.
- Video or audio signals cannot be input to this monitor without optional input cards.
- In these instructions, all explanations (except where noted) refer to the BT-H1700B with input cards installed.

SCREEN BURN

- It is not recommended to keep a certain still image displayed on screen for a long time as well as displaying extremely bright images on screen. This may cause a burning (sticking) phenomenon on the screen of cathode-ray tube. This problem does not occur as far as displaying normal video playback motion images.

■ HANDLING

- Avoid shocks or vibrations. These may damage the unit and cause it to malfunction.
- Do not block the ventilation slots.
- Do not expose this unit to high temperatures. Extended exposure to direct sunlight or a heater could deform the cabinet or cause the performance of internal components to deteriorate.
- Do not place the unit near appliances generating strong electric or magnetic fields. These can generate picture noise and instability.
- Keep the monitor clean by wiping the cabinet and CRT screen with a piece of soft cloth. Do not apply thinner or benzine. These chemicals can damage the finish and erase printed letters. When the unit is excessively dirty, use a diluted neutral cleanser, then wipe away the cleanser with a dry cloth.

DEGAUSS

- Do not use a magnet eraser to degauss the monitor's cathode ray tube from the outside. Doing so may distort its aperture grill and cause a malfunction.

CONTENTS

- SAFETY PRECAUTIONS 2**
- CONTROLS AND FEATURES..... 4**
- CONTROLS AND FEATURES
(INPUT CARD: OPTIONAL) 7**
- PREPARATION 9**
- BASIC MENU OPERATIONS
(MAIN MENU, SET-UP MENU) 11**
- HOW TO USE “MAIN MENU” 13**
- HOW TO USE “SET-UP MENU” 16**
- HOW TO USE EXTERNAL CONTROL 21**
- TROUBLESHOOTING 23**
 - SELF-CHECK INDICATIONS 25**
- SPECIFICATIONS 26**

CONTROLS AND FEATURES

FRONT VIEW

<Front Panel>

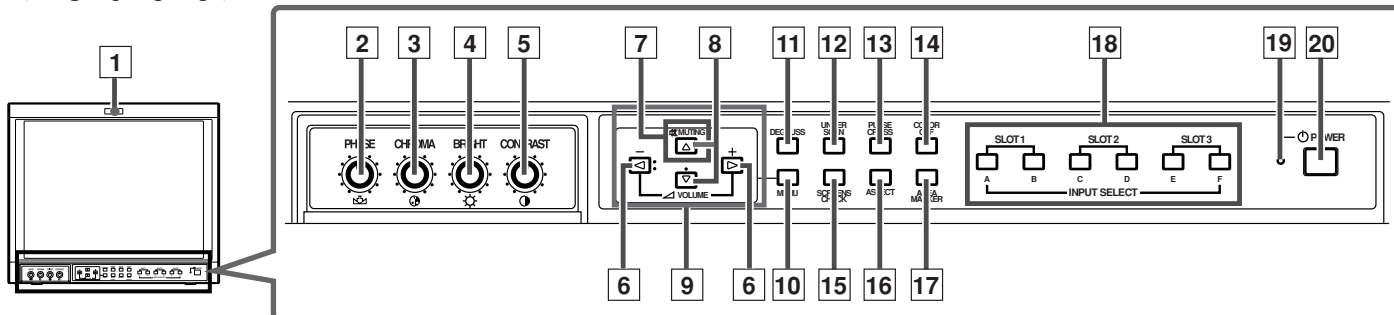

1 Tally lamp

Lights when the tally control signal is ON.

- Set the MAKE/TRIGGER terminal's tally control in the REMOTE (external control) terminal setup menu. The lamp color can be set to red or green.
- To set the color, use TALLY SELECT in the "FUNCTION SETTING" setup menu or MAKE/TRIGGER in the REMOTE (external control) terminal setup menu.

➔ For details, refer to pages 17 and 21.

2 PHASE adjustment knob

Adjusts picture hue.

- Turn the knob to the left to make the picture redder, and turn it to the right to make the picture greener.

3 CHROMA adjustment knob

Adjusts picture color density.

- Turn the knob to the left to make the picture color lighter, and turn it to the right to make the picture color deeper.

4 BRIGHT adjustment knob

Adjusts picture brightness.

- Turn the knob to the left to make the picture darker, and turn it to the right to make the picture brighter.

5 CONTRAST adjustment knob

Adjusts picture contrast.

- Turn the knob to the left to make the picture contrast lower, and turn it to the right to make the picture contrast higher.

6 VOLUME buttons

Adjusts the speaker volume.

- Pressing this button displays the VOLUME level bar on the screen. Pressing the button again allows you to adjust speaker volume.

7 MUTING button

Pressing this button mutes the output sound.

- To cancel "MUTING ON" (no sound), press MUTING button again, or press the VOLUME "-" or "+" buttons.

NOTE:

When a menu or setting item (such as MAIN MENU, SET-UP MENU, sub-menu, or VOLUME bar) is displayed on the screen, this button functions as a control button for the menu screen. In this case, it will not mute the sound when pressed.

8 EMBEDDED AUDIO channel switch button

Press this button while the VOLUME bar is displayed on the screen to change the input sound channel.

- When the button is pressed, the next highest channel is selected.
- When the button is pressed, the next lowest channel is selected.

NOTES:

Switchable channels correspond with the group selected in the "E.AUDIO GROUP" of the "FUNCTION SETTING" setup menu.
* Valid when an input card compliant with EMBEDDED AUDIO is installed.

9 Menu select buttons

Selects menu screen items or set-up menu screen.

10 MENU button

Displays, adjusts or closes a menu screen.

11 DEGAUSS button/lamp

Press the DEGAUSS button. The button lights and degaussing is performed automatically.

- When the degaussing is completed, the light goes off.

12 UNDER SCAN button/lamp

Press the UNDER SCAN button. The button lights and the screen is reduced (under-scan) and the whole screen is displayed.

- When the UNDER SCAN button is pressed while lit, the light goes off and the screen returns to normal size (over-scan).
- Use this function to check the whole screen.

NOTE:

This function is invalid with the RGB-input screen.

13 PULSE CROSS button/lamp

When you press the PULSE CROSS button, the button lights and the picture moves horizontally and vertically. The synchronized signal is displayed and the screen automatically brightens to make it easier to confirm the synchronized sections.

- When the PULSE CROSS button is pressed while lit, the light goes off and the normal screen is restored.

NOTE:

This function is invalid with the RGB-input screen.

14 COLOR OFF button/lamp

When you press the COLOR OFF button, the button lights and the screen becomes monochrome. Only the brightness signal is displayed.

- When the COLOR OFF button is pressed while lit, the light goes off and the normal screen is restored.
- Use this function to confirm the noise in the brightness signal or to confirm the white balance.

NOTE:

This function is invalid with the RGB-input screen.

15 SCREENS CHECK button/lamp

Press the SCREENS CHECK button. The button lights and the screen changes in the following order:

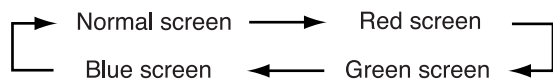

- Press the SCREENS CHECK button when the blue screen is displayed. The light goes off and the normal screen is restored.
- Use this function to confirm or adjust CHROMA or PHASE.

NOTE:

This function is invalid with the RGB-input screen.

16 ASPECT button/lamp

When the ASPECT button is pressed while the screen ratio is 4:3, the button lights and the screen ratio changes to 16:9.

- When the ASPECT button is pressed while lit, the light goes off and the normal screen is restored.

NOTE:

This function is invalid with the RGB-input screen.

17 AREA MARKER button/lamp

This button turns the AREA MARKER function ON/OFF.

- AREA MARKER function includes MARKER SELECT, ZOOM, and SAFETY MARKER functions. Refer to "AREA MARKER" on page 14 for more information.
- When AREA MARKER is set to ON, the button lights.

NOTES:

- Functions do not operate when they are set to OFF in the "AREA MARKER".
- Initial setting of each function in the "AREA MARKER" Menu is OFF. Before you can use the AREA MARKER function, you must change the "AREA MARKER" Menu settings first. Refer to "AREA MARKER" on page 14 for details.
- This button does not operate when RGB is input.
- The ZOOM function does not operate in the under-scan mode.

18 INPUT SELECT button/lamp

Selects an input signal from one of the input cards installed in the monitor's card slots (SLOT1 – SLOT3).

Select SLOT1: press A or B

Select SLOT2: press C or D

Select SLOT3: press E or F

- ➔ Refer to the input card instructions on pages 7 and 8 for details on the correspondence between the input terminals and the INPUT SELECT buttons.

- The INPUT SELECT button corresponding to the current input signal lights.
- When the input is switched, the new input status is displayed on the screen for about 3 seconds.
- To display the current input status again, press the illuminated INPUT SELECT.

■ About status display

Displays information on the current input selection and the monitor settings.

INPUT C Selected input

VIDEO Input card status (*1)

NTSC Signal format (*2)

HIGH Setting of "COLOR TEMP." (*3)

EXT SYNC External synchronization (*4)

*1 Notes

- "NO SLOT" is displayed when there is no input card inserted in the slot corresponding to the selected input.
- "COMPO." or "RGB" is displayed when a component or RGB signal (input from COMPONENT/RGB INPUT CARD) is selected.
- "VIDEO(Y/C)" is displayed when S-video is input from VIDEO 2 (INPUT SELECT B/D/F).

*2 Notes

- "NO SYNC" is displayed when no video signal is input.
- When "SYNC SELECT" is set as "EXT." (external), "NO SYNC" is displayed even when a video signal is input and a synchronized signal is not input. Refer to "SYNC SELECT" on page 17 for more information.

*3 Note

Refer to "COLOR TEMP." on page 18 for details on "COLOR TEMP." settings.

*4 Note

When "SYNC SELECT" is set to "INT." (internal synchronization), no message is displayed. Refer to "SYNC SELECT" on page 17 for more information.

CONTROLS AND FEATURES

(INPUT CARD: OPTIONAL)

VIDEO INPUT CARD (BT-YA701P)

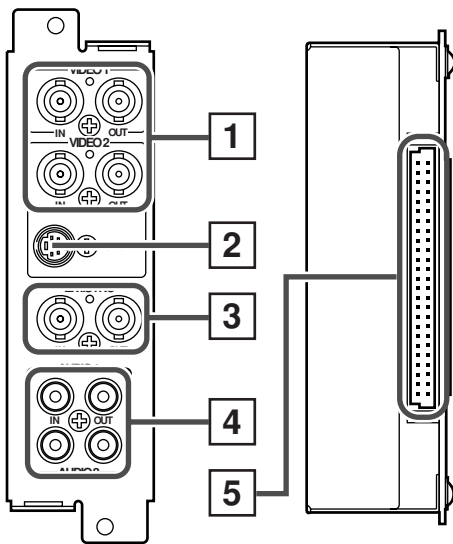

Compatible signal formats:
NTSC (3.58 MHz), PAL (4.43 MHz), black-and-white (50 Hz/60 Hz)

1 Composite signal input/output terminals (VIDEO 1, VIDEO 2)

Input (IN) and output (OUT) terminals for the composite video signals of the NTSC, PAL, and black/white (50 Hz/60 Hz).

➔ NTSC and PAL are switched in the "COLOR SYSTEM". Refer to "COLOR SYSTEM" on page 17.

Select VIDEO 1: press INPUT SELECT A (SLOT1)/C (SLOT2)/E (SLOT3) buttons.

Select VIDEO 2: press INPUT SELECT B (SLOT1)/D (SLOT2)/F (SLOT3) buttons.

* The IN and OUT terminals are bridge-connected (auto termination).

2 S-video signal input terminal (only for VIDEO 2)

Input terminal for the S-video signal.

• When an S-video signal is input to this terminal and a video signal is input to VIDEO 2, the S-video signal has priority over the video signal.

3 Synchronized signal input/output terminals (for both VIDEO 1 and VIDEO 2)

Input (IN) and output (OUT) terminals for the complex synchronized signals.

➔ To use these terminals, set "SYNC SELECT" to "EXT." Refer to "SYNC SELECT" on page 17 for more information.

NOTES:

• When an external synchronized signal is input, external synchronization is prioritized for both VIDEO 1 and VIDEO 2.

• External synchronization does not function when a video signal (except black burst signal) is included in the complex synchronized signal.

4 Audio signal input/output terminals (for both VIDEO 1 and VIDEO 2)

Input (IN) and output (OUT) terminals for analog audio signals corresponding to VIDEO 1 and VIDEO 2.

• The IN and OUT terminals are bridge-connected.

5 Connection terminal

Attach to the connection terminal of your Multi-Format Monitor.

COMPONENT/RGB INPUT CARD (BT-YA702P)

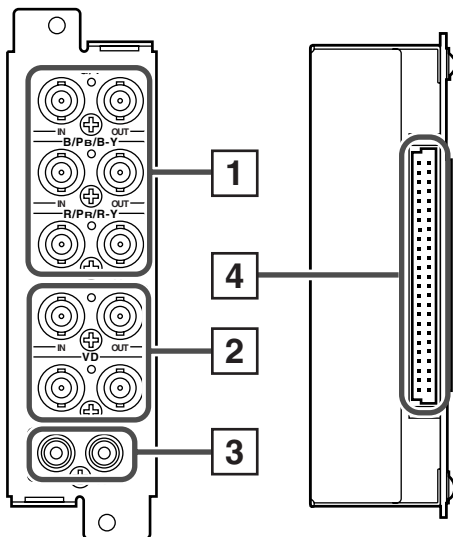

Compatible signal formats:
480/60i, 576/50i, 576/50p, 480/60p, 720/50p,
720/60p, 1035/60i, 1080/50i, 1080/60i,
1080/24psF

1 Component/RGB signal input/output terminals

Input (IN) and output (OUT) terminals for component (color difference) or RGB signals.

Select component signal: INPUT SELECT A (SLOT1)/C (SLOT2)/E (SLOT3)

Select RGB signal : INPUT SELECT B (SLOT1)/D (SLOT2)/F (SLOT3)

* The IN and OUT terminals are bridge-connected (auto termination).

2 Synchronized signal input/output terminals

Input (IN) and output (OUT) terminals for the vertical, horizontal or complex synchronized signals.

• To use these terminals, set "SYNC SELECT" to "EXT."

➔ Refer to "SYNC SELECT" on page 17 for more information.

3 Audio input/output terminals

Input (IN) and output (OUT) terminals for the analog audio signals.

• The IN and OUT terminals are bridge-connected.

4 Connection terminal

Attach to the connection terminal of your Multi-Format Monitor.

CONTROLS AND FEATURES

(INPUT CARD: OPTIONAL) (cont'd)

SDI INPUT CARD (BT-YA703P)

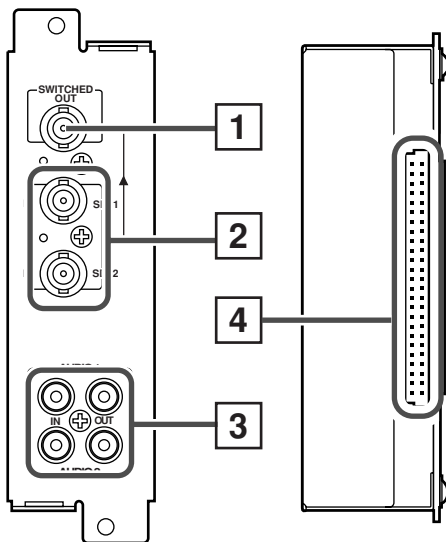

Compatible signal formats:
480/60i, 576/50i

1 SWITCHED OUT terminal

Output (OUT) terminal for the re-clocked signal. The input signal from SDI 1 or SDI 2 (selected with the INPUT SELECT buttons) is re-clocked and output from this terminal.

NOTES:

- Even when the input signal is switched from the SDI Input Card, the SWITCHED OUT terminal still outputs the SDI 1 or SDI 2 re-clocked signal (whichever you selected last).
- No signal is output from the SWITCHED OUT terminal when the monitor is turned off or in the stand-by mode.

2 D1 SDI signal input terminal (SDI 1, SDI 2)

Accepts an SMPTE259M compliant D1 SDI signal (component serial digital signal).

Select SDI 1 input: press INPUT SELECT A (SLOT1)/C (SLOT2)/E (SLOT3) buttons.
Select SDI 2 input: press INPUT SELECT B (SLOT1)/D (SLOT2)/F (SLOT3) buttons.

NOTE:

Not compliant with EMBEDDED AUDIO.

3 Audio signal input/output terminals (for both SDI 1 and SDI 2)

Input (IN) and output (OUT) terminals for the analog audio signals.

- The IN and OUT terminals are bridge-connected.

4 Connection terminal

Attach to the connection terminal of your Multi-Format Monitor.

HD SDI INPUT CARD (BT-YA705G)

Compliant with EMBEDDED AUDIO

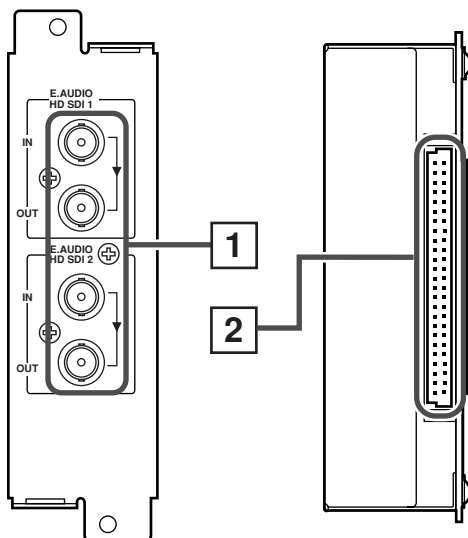

Compatible signal formats:
720/50p, 720/60p, 1080/50i, 1080/60i,
1035/60i, 1080/24psF, EMBEDDED AUDIO

1 HD SDI signal input/output terminals (HD SDI 1, HD SDI 2)

Input (IN) and output (OUT) terminals for the HD SDI signal (HD component serial digital signal).

This card is also compatible with EMBEDDED AUDIO signals with a 48 kHz sampling frequency and channel range of 1 to 8 channels.

- ➔ The EMBEDDED AUDIO output channel is controlled from this monitor. Refer to "EMBEDDED AUDIO channel switch button" on page 4 for more information.

Select HD SDI 1 input: press INPUT SELECT A (SLOT1)/C (SLOT2)/E (SLOT3) buttons.

Select HD SDI 2 input: press INPUT SELECT B (SLOT1)/D (SLOT2)/F (SLOT3) buttons.

OUT terminal

The re-clocked HD SDI 1 and/or HD SDI 2 input signal is output from the HD SDI 1 OUT and/or HD SDI 2 OUT terminal.

NOTE:

Signals cannot be output from the OUT terminal when the monitor's power is OFF or in the stand-by mode.

2 Connection terminal

Attach to the connection terminal of your Multi-Format Monitor.

PREPARATION

INSTALLING THE INPUT CARD

Optional input cards are necessary to use the functions of this monitor. Before mounting the monitor or connecting other equipment to the monitor, be sure to install the input cards.

1. Turn off the Multi-Format Monitor's main power and unplug the power cable from the AC outlet.
2. Unscrew the screws and remove the slot cover from the slot (on the rear side of the monitor) in which you are going to install the card.

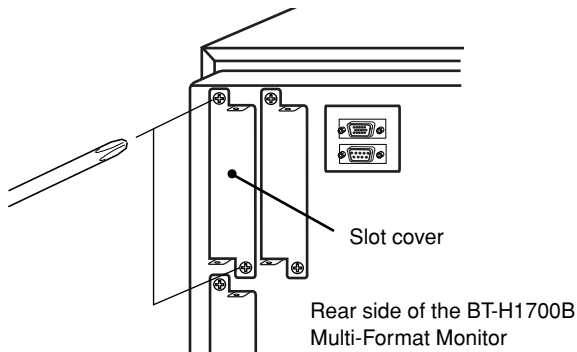

3. Insert the Input Card's board (green-colored) into the slot, fitting the board into the guide rails on the top and bottom of the slot.

Knob

Guide rails

Input card (the illustration shown is of the BT-YA701P)
Knob

4. Push the Input Card in so that its front panel touches the monitor's rear panel.
5. Secure the Input Card by replacing the screws removed in Procedure 2.

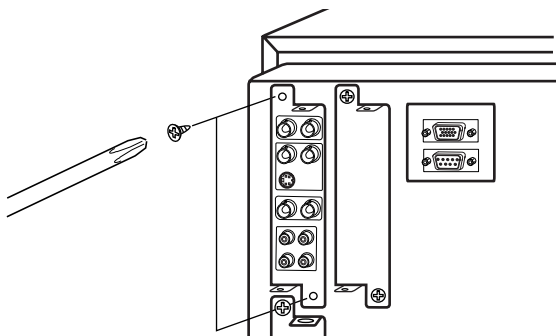

NOTES:

- Do not touch the terminal connected to the monitor or board pattern.
- Do not remove slot covers from the monitor's slots if they are not in use.

ATTACHING THE WIDE MASK

A wide mask is provided with the monitor. This changes the viewable screen area to the 16:9 aspect ratio.

- The wide mask cannot be attached to the monitor after the monitor is mounted in a rack. Mount the wide mask before installing the monitor in a rack.

1. Prepare the provided wide mask and 4 screws (for attaching).
2. Attach the wide mask to the monitor.

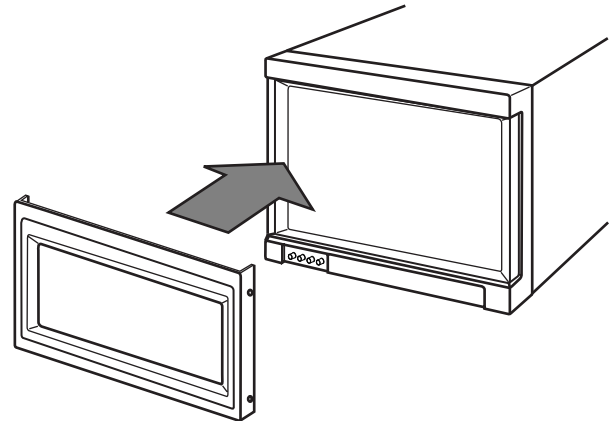

3. Secure the wide mask with the screws (fix 2 screws each to both right and left side).

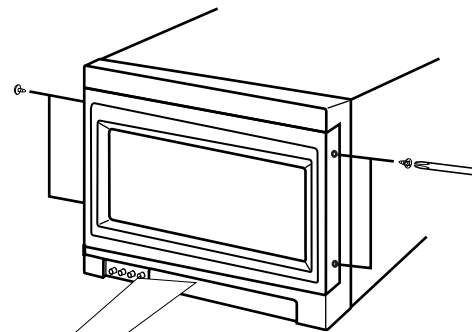

- When detaching the wide mask, follow this procedure in reverse.

Caution:
Use only the provided screws.

PREPARATION (cont'd)

ATTACHING THE POWER CORD HOLDER

- The provided Power Cord Holder prevents accidental disconnection of the AC power cord from the AC inlet.
- The Power Cord Holder consists of two parts; a case and cover.

1. Attach the Power Cord Holder case to the AC inlet on the back of the monitor with 2 screws (provided).

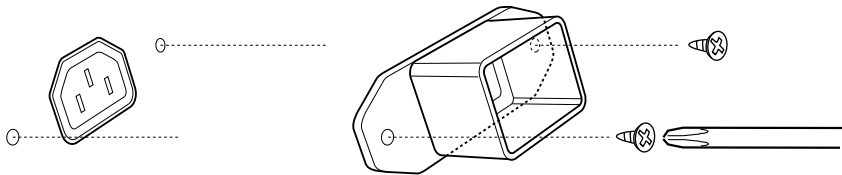

Caution:

Use only the provided screws.

2. Attach the Power Cord Holder cover to the AC power cord.

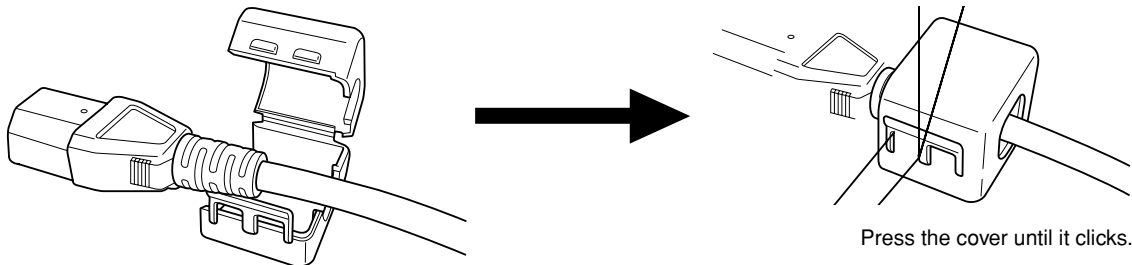

3. Connect the AC power cord to the AC inlet, and join the Power Cord Holder cover with the case.

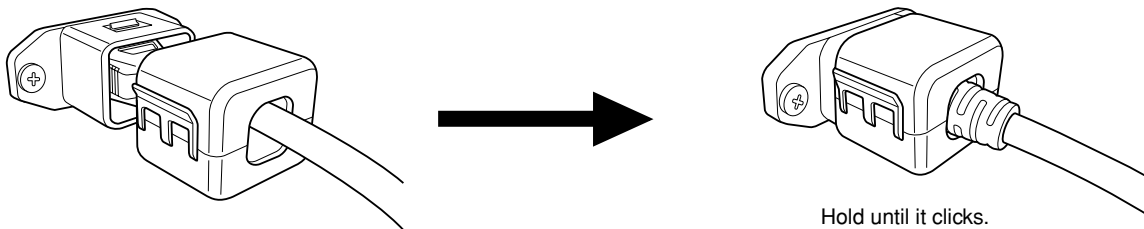

Caution:

- A different plug shape will result in the cover being attached to a different position.
- Check to make sure the plug doesn't pull out after the cover is attached.

Note:

To disconnect the power cord, click the tab to open the cover.

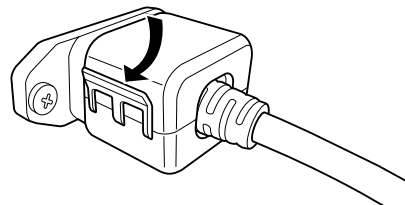

BASIC MENU OPERATIONS

(MAIN MENU, SET-UP MENU)

ABOUT MENU SCREENS

This monitor features a MAIN MENU (main menu screen) and a SET-UP MENU (setup menu screen). The MAIN MENU contains the functions normally used, and the SET-UP MENU contains the settings required for initial setup.

“MAIN MENU”

Items	Functions	Displays
1 APERTURE CONTROL	Compensates the frequency characteristics of the input video signal.	*1
2 SLOT CONDITION	Displays the status of the input cards installed in each of the input card slots.	
3 sub menu POSI.	Selects the display position of the sub menu superimposed on the screen.	
4 AREA MARKER	Controls ON/OFF and other settings of the MARKER SELECT, SAFETY MARKER, and ZOOM functions included in the AREA MARKER function.	*2
5 COLOR MATRIX	Selects or adjusts the picture color matrix.	*1

About “Displays” *1 : Not displayed when an RGB signal is input.

*2 : Displayed only when the screen ratio is 16:9. Not displayed when an RGB signal is input.

When some items are not displayed depending on the input signals, subsequent items will move up. Position of the menu varies depending on the type of signal.

“SET-UP MENU”

Items	Functions
1 FUNCTION SETTING	Selects the control systems for the COLOR SYSTEM, synchronized signal, RUSH DELAY TIME, tally lamp colors, and MAKE/TRIGGER terminal. * Checks the amount of time that the monitor has been used. * Selects the audio channel group for the EMBEDDED AUDIO. (When an input card compliant with EMBEDDED AUDIO is installed.)
2 PICTURE SUB ADJ.	Controls the approximate adjustment of the video control level when the video adjustment knob is adjusted to the center. * Can also be used to switch the NTSC set-up level, and change the component signal's input level settings.
3 COLOR TEMP./BAL.	Sets or adjusts the color temperature or white balance.
4 SIZE/POSI. ADJ.	Adjusts the size or position of the picture.
5 DISTORTION ADJ.	Compensates the picture distortion.
6 STATUS DISPLAY	Sets the status display ON/OFF. * Switches the display on and off. Also selects the type of display.
7 CONTROL LOCK	Sets the control lock preventing the monitor from misuse.
8 all reset	Sets all items in SET-UP MENU to factory-preset values.

BUTTONS FOR MENU OPERATIONS

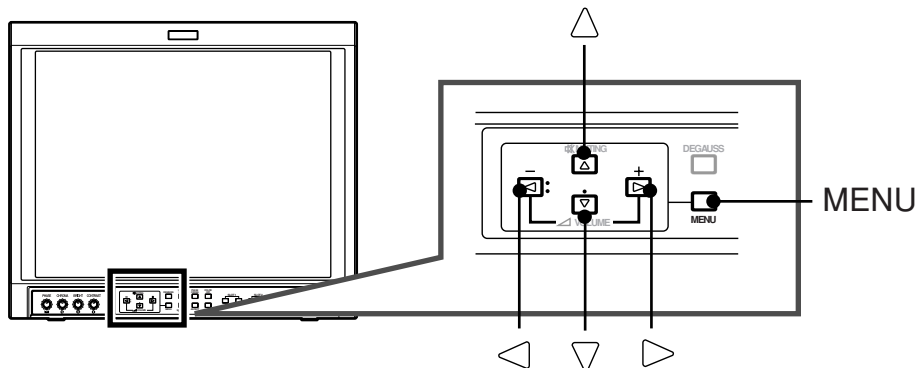

BASIC MENU OPERATIONS

(MAIN MENU, SET-UP MENU) (cont'd)

■ DISPLAYING THE MENU SCREENS

- To display MAIN MENU
Press the MENU button on the front panel.
- To display SET-UP MENU
Press the ◀ button while pressing the ▽ button on the front panel.

NOTES:

- To exit the MENU, press the MENU button several times.
- The MENU automatically exits about 30 seconds after the last Menu operation.
- To go back the previous MENU, press MENU.

■ MENU OPERATION PROCEDURE

Example: Adjusting the "BRIGHT" value to "+10".

1. Press the ◀ button while ▽ button is pressed.
"SET-UP MENU" is displayed on the screen.

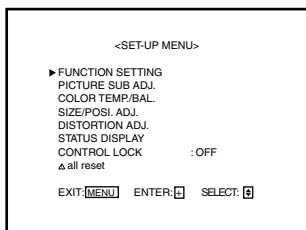

2. Select "PICTURE SUB ADJ." by pressing the ▽ button, then press the ▶ button.
"PICTURE SUB ADJ." menu is displayed on the screen.

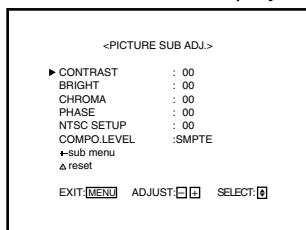

3. Select "BRIGHT" by pressing the ▽ button .
4. Press the ◀ and/or ▶ buttons as many times as required to obtain the brightness desired.
Example: Setting brightness to "+10".

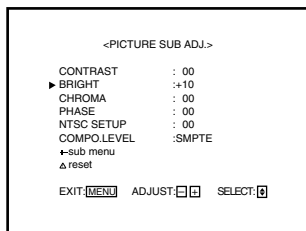

5. Delete the "SET-UP MENU" by pressing the MENU button several times.

■ About "+ sub menu"

Only displays selected items. (sub-menu display) Allows you to adjust and set items while looking at the actual screen.

NOTE:

This function is available only when "+ sub menu" is displayed in the MENU.

Example: Setting an item in the "PICTURE SUB ADJ." with the sub-menu.

1. Press the ◀ button while ▽ button is pressed.
"SET-UP MENU" is displayed on the screen.
2. Select "PICTURE SUB ADJ." by pressing the ▽ button, then press the ▶ button.
3. Select "+ sub menu" by pressing the ▽ button several times, then press the ▶ button.
The adjustment bar is displayed at the bottom or top of the screen.
4. Select the desired setup item by pressing the △ and ▽ buttons (several times).
5. Press the ◀ and/or ▶ buttons as many times as required to obtain the desired setting.

- To delete the sub-menu display:
Press the MENU button on the front panel.
 - The previous MENU display is restored.
- To change the position of the sub-menu display
 1. Display the "MAIN MENU" by pressing the MENU button.
 2. Select "sub menu POSI." by pressing the ▽ button several times.
 3. Set "UPPER" or "LOWER" by pressing the ◀ and ▶ buttons.

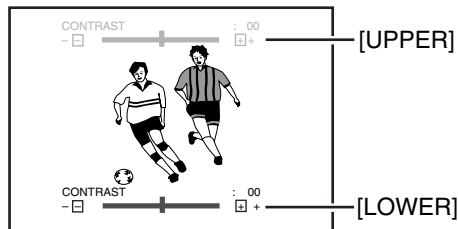

■ About "reset"

Restores all MENU settings (currently displayed) to factory-preset values.

Select "reset" using the △/▽ buttons, then press the ▶ button.

NOTE:

This function is only available when "reset" is displayed in the MENU.

HOW TO USE "MAIN MENU"

"MAIN MENU" SCREENS

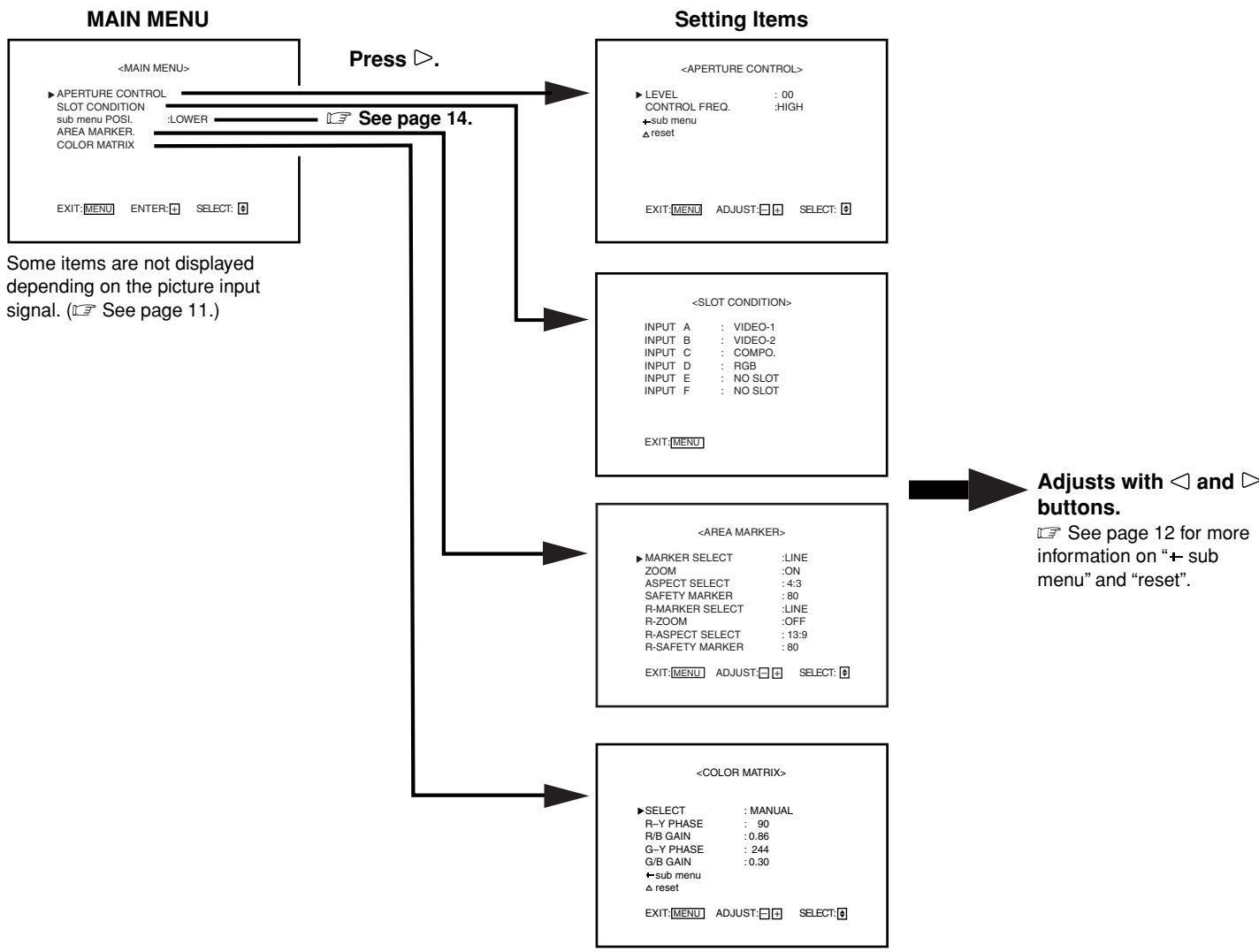

* To go back the previous MENU, press MENU.

HOW TO USE “MAIN MENU” (cont’d)

ITEM CONTENTS AND ADJUSTMENT RANGE/SETTINGS

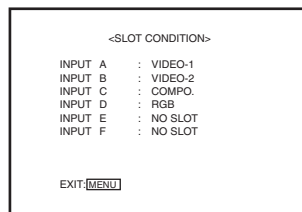
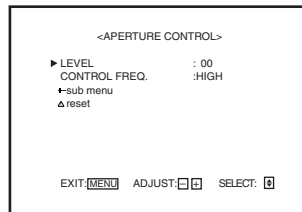

AREA MARKER:

Controls ON/OFF and other settings of the MARKER SELECT, SAFETY MARKER, and ZOOM functions included in the AREA MARKER function.

Press the \triangleright button to display the setting menu illustrated on the right.

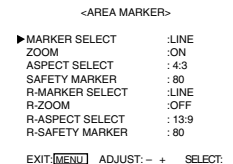

NOTES:

- For the 4:3 screen ratio, only SAFETY MARKER and R-SAFETY MARKER are displayed.
- To set up non-“R-” items, press the AREA MARKER button on the front panel. An external control system should not be operated at this time.
- To set up “R-” items, set the AREA MARKER function to ON via external control.
- Use the MAKE/TRIGGER terminal for external control of AREA MARKER function. Please note that this will only work when the AREA MARKER button on the front panel has been pressed (the AREA MARKER lamp will be illuminated). For details, refer to “HOW TO USE THE MAKE/TRIGGER TERMINAL” on page 21.

MARKER SELECT/R-MARKER SELECT

It displays the area of the aspect ratio that has been set in the ASPECT SELECT/R-ASPECT SELECT, superimposed on the current screen.

OFF : MARKER SELECT does not function.

LINE : Displays the area with an outline.

HALF : The area outside the specified screen ratio is displayed as a 50% transparency.

HALF+L : The area of the specified screen ratio is indicated by an outline, and the area outside of that is displayed as a 50% transparency.

BLK. : The area outside the specified screen ratio is black. Only the portion of the picture within the designated area is displayed.

BLK.+L : The area of the specified screen ratio is indicated by an outline, and the area outside of that becomes black so that only the area inside the line is displayed.

ZOOM/R-ZOOM

Zooms the center of the marked area.

OFF : Does not zoom.

ON : Zooms.

NOTES:

- Does not function when under-scan is operated.
- To adjust the zoom picture size, refer to “ZOOM H. SIZE” and “ZOOM V. SIZE” on page 19.

ASPECT SELECT/R-ASPECT SELECT

Selects the screen aspect ratio.

- **4:3/13:9/14:9**

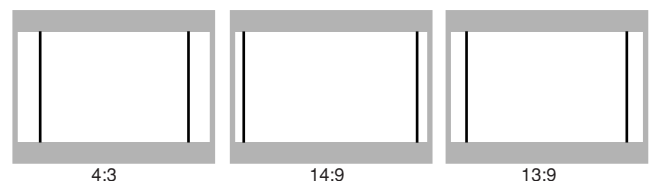

■ SAFETY MARKER/R-SAFETY MARKER

Displays dotted lines to indicate the areas corresponding to 80%, 88%, or 90% of the screen size (the aspect ratio setting in “ASPECT SELECT/R-ASPECT SELECT”).

- OFF : SAFETY MARKER does not function.
- 90% : Marked area is 90% of the 16:9 screen ratio.
- 88% : Marked area is 88% of the 16:9 screen ratio.
- 80% : Marked area is 80% of the 16:9 screen ratio.

NOTES:

- When a picture of 4:3 aspect ratio is input, SAFETY MARKER for 4:3 screen is displayed.
- To display SAFETY MARKER for 16:9 screen ratio when a picture of 16:9 aspect ratio is input, set “MARKER SELECT/R-MARKER SELECT” to OFF. (In this case, setting of ASPECT SELECT is invalid.)

COLOR MATRIX

Selects or adjusts the standard of the color demodulation (color rendering).

Press the \triangleright button to display the setting menu illustrated on the right.

```

-COLOR MATRIX-
▶SELECT          : MANUAL
R-Y PHASE       : 90
R/B GAIN        : 0.86
G-Y PHASE       : 244
G/B GAIN        : 0.30
sub menu
reset
EXIT: [MENU] ADJUST: [ ] + SELECT:
    
```

The menu screen when MANUAL is selected.

- The standard setting is set to “ITU601” or “ITU709” depending on the input signal format. The factory preset of MANUAL is ITU709.

Input Signal Format	Standard setting	Manual setting (MANUAL)
NTSC, PAL, 480/60i, 480/60p, 576/50i, 575/50p	ITU601	ITU709
720/50p, 720/60p, 1080/50i, 1080/60i, 1035/60i, 1080/24psF	ITU709	

■ SELECT

Selects the picture matrix standard.

- ITU601 or ITU709 : Standard setting
- MANUAL : Manual setting

NOTE:

The following items are displayed when MANUAL is selected. When ITU601 or ITU709 is selected, they are not displayed.

■ R-Y PHASE

Sets the R-Y phase.

- 90/92/94/112

■ R/B GAIN

Sets the R/B gain.

- 0.86/0.56/0.68/0.79

■ G-Y PHASE

Sets the G-Y phase.

- 244/253/236/240

■ G/B GAIN

Sets the G/B gain.

- 0.30/0.34/0.40/0.45

ITU601	R-Y PHASE	90
	R/B GAIN	0.79
	G-Y PHASE	244
	G/B GAIN	0.45
ITU709	R-Y PHASE	90
	R/B GAIN	0.86
	G-Y PHASE	244
	G/B GAIN	0.30

HOW TO USE "SET-UP MENU"

"SET-UP MENU" SCREENS

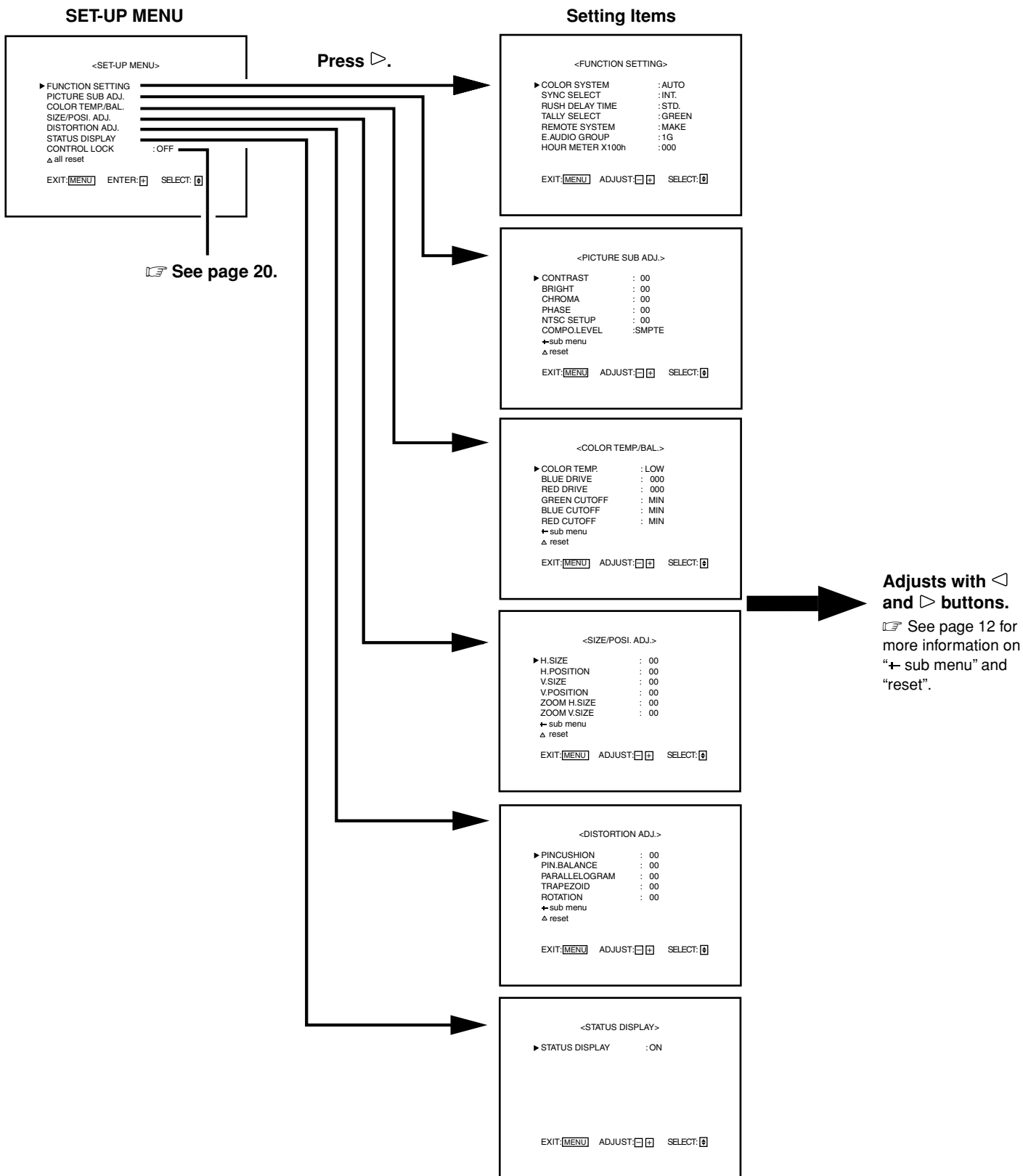

* To go back the previous MENU, press MENU.

ITEM CONTENTS AND ADJUSTMENT RANGE/SETTINGS

FUNCTION SETTING

Selects the control systems for the COLOR SYSTEM, synchronized signal, RUSH DELAY TIME, tally lamp colors, and MAKE/TRIGGER terminal.

- Checks the amount of time that the monitor has been used.
- Selects the audio channel group for the EMBEDDED AUDIO. (When an input card compliant with EMBEDDED AUDIO is installed.)

Press the \triangleright button to display the setting menu illustrated on the right.

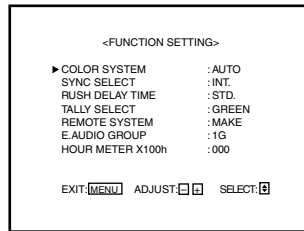

COLOR SYSTEM

Selects the color system when using the video input card.

- AUTO** : Changes NTSC and PAL automatically.
- NTSC** : Keeps the color system NTSC.
- PAL** : Keeps the color system PAL.

NOTE:

Normally select AUTO. However, if the input signal is unstable, select NTSC or PAL.

SYNC SELECT

Synchronized signal selection.

- INT.** : The input video signal is synchronized with the built-in sync signal.
- EXT.** : The input video signal is synchronized with an external signal from an external sync terminal.

RUSH DELAY TIME

Sets the time when the power supply to the monitor's circuits (excluding the micro computers) starts after the power switch is pressed.

- STD.** : The power supply starts approx. 1 second after the power switch is pressed.
- SLOW** : The power supply starts approx. 3.2 seconds after the power switch is pressed.

NOTE:

If you are going to turn several Multi-Format Monitors on at the same time, it is recommended to apply SLOW to some of the monitors to control rush current.

TALLY SELECT

Selects the color of the tally lamp (when lit) on the upper front panel.

- GREEN** : The tally lamp lights in green.
- RED** : The tally lamp lights in red.

REMOTE SYSTEM

Selects the control system for the MAKE/TRIGGER terminals. Refer to "HOW TO USE THE MAKE/TRIGGER TERMINAL" on page 21.

- **MAKE (make contact)/TRIGGER (trigger contact)**

E.AUDIO GROUP

Selects the audio channel group for EMBEDDED AUDIO. It is displayed when an input card compliant with EMBEDDED AUDIO is installed.

1G/2G/1-2G

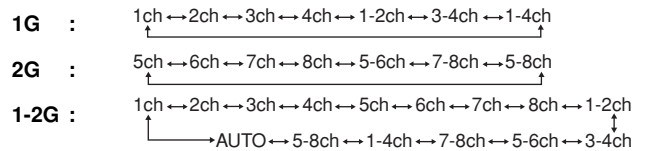

NOTE:

The auto setting mixes and outputs all 8 signal channels. Sets the output level automatically by detecting the number of channels receiving the signal.

* About sound output level

Sound output level is set to a standard output level for all channels when several sound channels are output at the same time. The more channels are selected, the lower each channel's level will be. (Each channel's level becomes half for 1-2 channel, 1/4 for 1-4 channel.)

HOUR METER X100h

Displays the total usage time of the monitor in hundred-hour units.

- **000 ~ 655**

NOTES:

- When the timer passes 655, it returns to 000.
- The timer does not count the usage time under one hour.

HOW TO USE “SET-UP MENU” (cont’d)

COLOR TEMP./BAL.

Sets or adjusts the color temperature or white balance.

Press the ▷ button to display the setting menu illustrated on the right.

- Use the five items indicated with ※ mark to make fine adjustments between the monitors.

■ COLOR TEMP.

SIZE/POSI. ADJ.

Adjusts the size or position of the picture.

Press the \triangleright button to display the setting menu illustrated on the right.

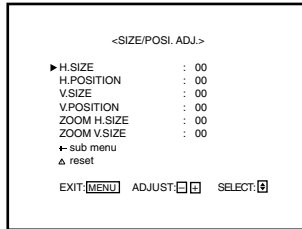

■ H.SIZE

Adjusts the horizontal screen size.

• **-20 ~ 00 ~ +20 (*)**

- : Reduces the screen size horizontally.
- + : Enlarges the screen size horizontally.

* Reduced to 00 ~ +20 during the under-scan mode.

■ H.POSITION

Adjusts the horizontal screen position.

• **-20 ~ 00 ~ +20**

- : Move the screen to the left.
- + : Move the screen to the right.

■ V.SIZE

Adjusts the vertical screen size.

• **-20 ~ 00 ~ +20**

- : Reduces the screen size vertically.
- + : Enlarges the screen size vertically.

■ V.POSITION

Adjusts the vertical screen position.

• **- 20 ~ 00 ~ + 20**

- : Move the screen up.
- + : Move the screen down.

■ ZOOM H. SIZE

• **- 20 ~ 00**

■ ZOOM V. SIZE

• **-20 ~ 00 ~ +20**

NOTE:

ZOOM H. SIZE and ZOOM V. SIZE are displayed only when the ZOOM function is operated. ZOOM H. SIZE adjusts the screen size horizontally, and ZOOM V. SIZE adjusts it vertically when the ZOOM is operated.

DISTORTION ADJ.

Compensates the picture distortion.

Press the \triangleright button to display the setting menu illustrated on the right.

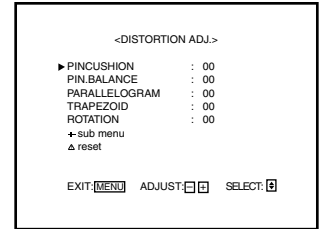

■ PINCUSHION

Compensates pincushion picture distortion.

• **-20 ~ 00 ~ +20**

- : Expands both left and right sides of the picture.
- + : Squeezes both left and right sides of the picture.

■ PIN.BALANCE

Adjusts the compensation balance of the pincushion picture distortion.

• **-20 ~ 00 ~ +20**

- : The picture is expanded on the left side, and squeezed on the right side.
- + : The picture is squeezed on the left side, and expanded on the right side.

■ PARALLELOGRAM

Compensates parallelogram picture distortion.

• **-20 ~ 00 ~ +20**

- : Moves the upper side of the picture to the right, and the lower side to the left.
- + : Moves the upper side of the picture to the left, and the lower side to the right.

■ TRAPEZOID

Compensates trapezoid picture distortion.

• **-20 ~ 00 ~ +20**

- : Enlarges the upper side of the picture.
- + : Reduces the upper side of the picture.

■ ROTATION

Compensates for picture tilt.

• **-31 ~ 00 ~ +31**

- : Turns the picture clockwise.
- + : Turns the picture counterclockwise.

HOW TO USE “SET-UP MENU” (cont’d)

STATUS DISPLAY

Sets the status display ON/OFF.

* Switches the display on and off. Also selects the type of display.

Press the \triangleright button to display the setting menu illustrated on the right.

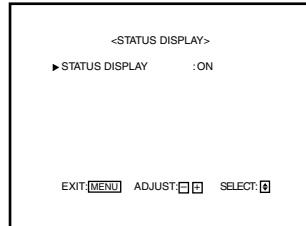

■ STATUS DISPLAY

Sets the status display ON or OFF.

ON : The information is displayed.

OFF : The information is not displayed.

CONTROL LOCK

■ CONTROL LOCK

Invalidates most of operations on the front panel (including menu screen operations).

OFF : Enables normal operations.

ON : Invalidates all operations except the power switch and CONTROL LOCK.

NOTE:

While CONTROL LOCK is set to ON, only the following operations are available:

– turning the monitor’s power ON or OFF.

– displaying the SET-UP MENU to set CONTROL LOCK to OFF.

Attempting to perform any other operation causes the “Control lock on!” warning to appear on the screen for approx. 3 seconds.

all reset

Resets all SET-UP MENU items to factory-preset values.

1. Select “all reset” by \triangle/∇ buttons, then press \triangleright button. Confirmation message is displayed.

2. To initialize, press \triangleright button.

To cancel the initialization, press the MENU button.

HOW TO USE EXTERNAL CONTROL

ABOUT EXTERNAL CONTROL

The Multi-Format Monitor has two external control terminals.

One is the MAKE/TRIGGER terminal, which allows the monitor to be controlled by the MAKE (make contact) or TRG. (trigger contact) method selected in the function setting.

MAKE (make contact system): Controls functions either by short-circuiting (short with GND of 15th terminal) or stable disconnection (terminal open) of the controlled terminal.

TRG. (trigger system) : Controls the function by instantaneously (one second) short-circuiting (short with GND of 15th terminal) the controlled terminal.

* MAKE or TRIGGER are selected from REMOTE SYSTEM in the setup menu.

The other terminal used for remote control is the RS-232C terminal, and this allows the monitor to be controlled by serial communication.

NOTE: Control priority is in the following order; ① MAKE/TRIGGER terminal > ② RS-232C terminal > ③ front panel buttons.
When trigger contact is on, the front panel buttons can be operated.

HOW TO USE THE MAKE/TRIGGER TERMINAL

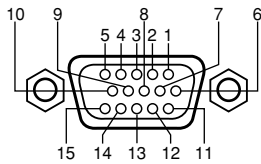

No.	Functions to be controlled	Disconnection	Short-circuiting	*1
1	Turns on the tally lamp	Off	On	*2
2	Changes the input to INPUT A	Invalid	Valid	
3	Changes the input to INPUT B	Invalid	Valid	
4	Changes the input to INPUT C	Invalid	Valid	
5	Changes the input to INPUT D	Invalid	Valid	
6	Changes the input to INPUT E	Invalid	Valid	
7	Changes the input to INPUT F	Invalid	Valid	
8	COLOR OFF	Off	On	
9	AREA MARKER	Off	On	
10	ASPECT	Off	On	
11	TALLY SELECT	GREEN	RED	
12	AREA MARKER set-up	without "R-"	with "R-"	*3
13	STATUS DISPLAY	ON	OFF	
14	External Control	Invalid	Valid	*2
15	GND			

*1 : The TRIGGER (trigger contact) system switches each setting by instantaneously (approx. 1 second) short-circuiting (short with GND of 15th terminal) the controlled terminal.

*2 : TALLY (1st terminal) and EXTERNAL CONTROL (14th terminal) must be controlled with the MAKE (make contact) system even under the TRIGGER (trigger contact) system.

*3 : Activating each with "R-" or without "R-" setting in the AREA MARKER menu is possible. Refer to "AREA MARKER" on page 14 for details.

Operation

1. Short-circuit EXTERNAL CONTROL (14th terminal) to GND (15th terminal) to activate the external control.
2. Under the MAKE system, controls each function by short-circuiting (short with GND of 15th terminal) or stable disconnection (terminal open) of the controlled terminal.
3. Under the TRIGGER (trigger contact) system, controls each function by Pulse Control, that is by instantaneously (approx. 1 second) short-circuiting (short with GND of 15th terminal) the controlled terminal.

NOTES:

- When using INPUT A (the 2nd pin) through INPUT F (7th terminal), only the terminal in use should be short-circuited, the others must be disconnected.
- Under the TRIGGER system, multiple terminals cannot be short-circuited to GND (15th terminal). Be sure to short-circuit the single terminal to GND.

HOW TO USE EXTERNAL CONTROL

(cont'd)

HOW TO USE THE RS-232C TERMINAL

You can control the monitor from your PC via the RS-232C terminal.

For details on operating the monitor from the PC, consult your dealer or service centre for details.

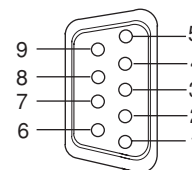

1. Cable

Prepare a straight cable with a D-sub connector (9-pin, female) and a D-sub connector (9-pin, male).

2. Communications Specifications

Baud Rate : 4800/9600/19200 (factory pre-set; 4800)
 Data Bits : 8 bits
 Parity : No parity
 Stop Bits : 1
 Flow Control : Hardware (RTS/CTS)

Pin No.	Signal
1	DCD (Data Carrier Detect)
2	RD (Receive Data)
3	TD (Transmit Data)
4	DTR (Data Terminal Ready)
5	GND (Ground)
6	DSR (Data Set Ready)
7	RTS (Request To Send)
8	CTS (Clear To Send)
9	RI (Ring Indication)

3. Commands

Format

Header	ID	Command	Data	CR
--------	----	---------	------	----

Header

- ! Control from the PC to the monitor
- ? Reference from the PC to the monitor
- @ Answer from the monitor to the PC

ID + Command + Data

B	Basic command	Characters	00, 01 or No data
D	Command for adjusting the picture size	00 ~ 08	-20 ~ +20 or -31 ~ +31
S	Command for adjusting the picture quality	00 ~ 05	-20 ~ +20
M	Command for selecting the menu item	00 ~ 0E	00, 01, 10, 11
F	Command for selecting the menu item	00 ~ 0A	00, 01
W	Command for adjusting the white balance	00 ~ 05	-256 ~ +255
C	Command for inquiring for the monitor's status	00	0 ~ 655

During Communication from the PC to the Monitor

The monitor receives the data when DSR remains ON (high) and CTS is set to ON.

During Communication from the Monitor to the PC

The monitor sends the data when both DSR and DCD are set to ON and RTS is set to ON.

Communication Procedures

The following is the communication procedures.

1. Starting the communication

Receives the connection command (!BCN1Cr) from the PC → Sends the monitor's status (@BOKCr) to the PC

2. Performing the external control

Receives the control command (!XXXXCr) from the PC → Sends the monitor's status (@BOKCr) to the PC

* The monitor repeats these receiving and sending if necessary.

3. Terminating the communication

Receives the termination command (!BCN0Cr) → Sends the monitor's status (@BOKCr) to the PC

* After sending the data to the monitor, the PC must first receive the data from the monitor and then send the next command because the communication is performed in a hand-shake system. If the PC does not receive the status from the monitor after sending the command, re-send the command.

TROUBLESHOOTING

Solutions to common problems related to your monitor are described here. If none of the solutions presented here solve the problem, unplug the monitor and consult a Panasonic-authorized dealer or service center for assistance.

Problems	Points to be checked	Measures (Remedy)	Reference pages
No power supply	Is the power plug loosened or disconnected?	Firmly insert the power plug.	—
	Is the main power turned OFF?	Turn the main power ON.	6
No picture with the power on	Is the signal cable disconnected?	Connect the signal cable firmly.	7, 8
	Is the power of the connected component ON? Is the signal output from the connected component?	Turn on the power of the connected component and set it correctly.	—
	Is the input signal selected correctly?	Select the correct input with the INPUT SELECT buttons.	5
	Is the input signal adapted to the monitor's specification?	Check that the input signal format corresponds to the installed input card format.	7, 8
	Are any of the self-check indicators (INPUT SELECT A through F buttons) blinking?	Follow the procedures in "SELF-CHECK INDICATIONS".	25
No sound	Is the audio cable disconnected?	Connect the audio cable firmly.	7, 8
	Is the audio signal output from the connected component?	Set the connected component correctly.	—
	Is the volume output set to minimum?	Adjust the speaker volume with the VOLUME (volume adjustment) buttons.	4
Wrong color	Has the picture adjustment been changed?	Set each picture adjustment knob to the standard (centered) position. Or, set each picture adjustment item in [PICTURE SUB ADJ.] in the <SET-UP MENU> screen to Standard (00) (or use the [reset] function).	4, 18
	Has the WHITE BALANCE setting been changed?	Set each [COLOR TEMP./BAL.] item in the <SET-UP MENU> screen to Standard (000) (or use the [reset] function).	18
	Are any cables connected to the component/RGB input card?	Connect each signal cable firmly.	7
	Has the correct signal been input to the component/RGB input card and the correct INPUT been selected on the monitor?	Select INPUT A/C/E when the component signal is input, or select INPUT B/D/F when the RGB signal is input.	7
Unnatural picture	Has [CONTRAST] or [BRIGHT] been changed?	Adjust the CONTRAST or BRIGHT picture adjustment knobs. Or, adjust the [CONTRAST] or [BRIGHT] item in [PICTURE SUB ADJ.] in the <SET-UP MENU> screen.	4, 18
Shaking picture	Is the monitor close to a motor, transformer or any other device generating a strong magnetic field? (a fan, fluorescent light, laser printer, another monitor, etc.)	Move the monitor away from the device until the picture stops shaking. Connect the power plug to another AC outlet away from the former one.	—

TROUBLESHOOTING (cont'd)

Problems	Points to be checked	Measures (Remedy)	Reference pages
Irregular color	Is the monitor placed or moved close to a speaker or any other device incorporating a magnet? Has the position of the monitor been changed with the power on?	Move the device away from the monitor. Press the DEGAUSS button on the front panel to degauss the screen. When degaussing, wait more than 30 minutes for maximum effect.	4
Wrong picture position, wrong picture size	Has the picture position, size or distortion been changed?	Adjust the picture size (H. SIZE, V. SIZE) or position (H. POSITION, V. POSITION) in the [SIZE/POS. ADJ.] item in the <SET-UP MENU> screen. Adjust the picture distortion (PINCUSHION, PIN. EALANCE, TRAPEZOID and PARALLELOGRAM) in the [DISTORTION ADJ.] item in the <SET-UP MENU> screen.	19
Front panel buttons and knobs do not function	Have the UNDER SCAN or ASPECT button been pressed?	When the UNDER SCAN or ASPECT button is lit, press each button to invalidate each setting.	4, 5
	Has the CONTROL LOCK function been set to ON? Has the monitor's setting been changed to enable control from an external unit via the REMOTE terminals?	Set the CONTROL LOCK function to OFF. Change the setting of the external control to control the monitor locally.	20 21, 22

The following are not malfunctions:

- You may see two horizontal lines on the monitor. They are the shadows of the "damper lines" that are necessary for composing the monitor. These lines are not a malfunction.

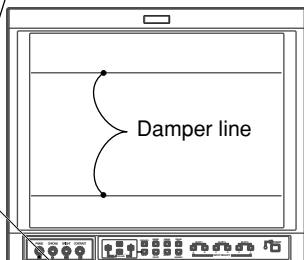

- About CRT tube reflection (when Zoom mode is used.)
The screen might appear as brownish white. This is due to a reflection of part of the image on the CRT caused by certain signal sources, and it is not a malfunction.

- When a bright still image (such as a white cloth) is displayed for a long period, it may appear to be colored. This is due to the structure of the cathode ray tube and will disappear when another image is displayed.
- You may sometimes experience a mild electric shock when you touch the picture tube. This phenomenon is due to a normal buildup of static electricity on the CRT and is not harmful.
- The monitor emits a strange sound when the room temperature changes suddenly. This is only a problem if an abnormality appears on the screen as well.
- If two or more monitors are operated next to each other, their images may shake or be distorted. This phenomenon is due to mutual interference; it is not a malfunction. Move the monitors away from each other until the interference disappears or turn the power off on any monitor that is not being used.

When black vertical lines appear on the screen

Black vertical lines may appear on the screen if the aperture grill is tilted as a result of being shaken or jolted during shipment.

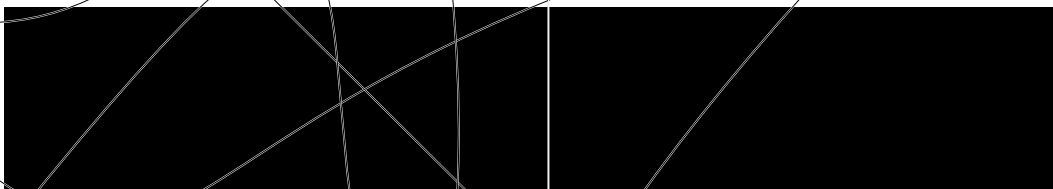

In this case, try tapping the monitor on the side. If this does not get rid of the lines, follow the procedure below.

1. Display a white screen, so that the problem area can be seen clearly.
2. Maximize the "CONTRAST" and "BRIGHT" adjustments, then place a bright white rectangle on the area.
3. After a while, the lines should disappear.

■ SELF-CHECK INDICATIONS

When the screen goes blank, and one or more of the INPUT SELECT A through F buttons on the front control panel start blinking...

This monitor has a self-check function, which allows it to detect malfunctions and alert you. This makes trouble-shooting easier. Whenever a problem occurs, a combination of “self-check indicators” (INPUT SELECT A through F buttons) will blink and the monitor’s power automatically turns off. If this happens, follow the steps below and contact your dealer to resolve the problem.

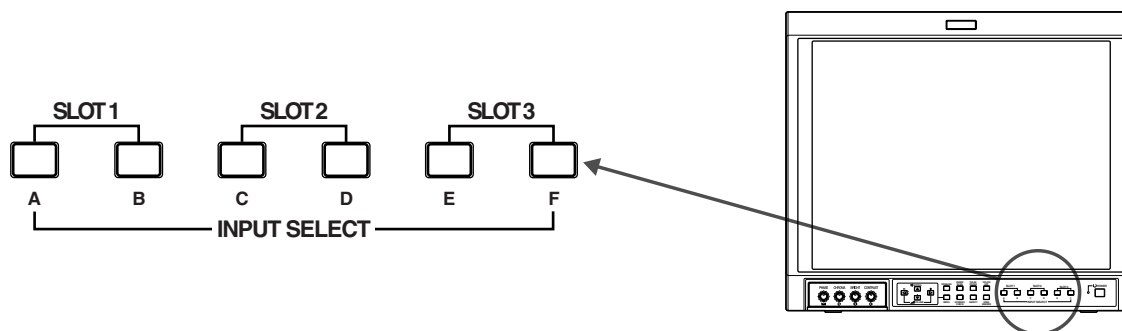

1. Check which indicators are blinking.
2. Turn off the main power switch on the back of the monitor.
3. Disconnect the Power Cord from the AC outlet.
4. Contact your dealer with the information about which indicators are blinking.

NOTE:

If you turn on the monitor's power immediately after turning it off (or after a short-term power failure), the self-check indicators may blink, and no image may be displayed.

When this happens, turn off the power, and wait at least 10 seconds before turning it on again. If the self-check indicators have stopped blinking, you can use the monitor as usual.

SPECIFICATIONS

- **Type** : Multi-Format Monitor
- **Picture Tube** : 17" measured diagonally
- **Effective Screen Size** : Width : 330 mm (13")
Height : 250 mm (9-7/8")
Diagonal : 410 mm (16-1/4")
- **Scanning Frequency** : H : 15 kHz/27 kHz – 45 kHz
V : 50 Hz – 80 Hz
- **Video Band** : Component : 25 MHz (–3 dB)
Video (Y/C) : 8 MHz (–3 dB)
- **Horizontal Resolution** : Video (Y/C) : 600 TV lines
1080/60i : 800 TV lines
- **Input Terminals** : Installing an optional input card in SLOT 1, 2, or 3 is required.
INPUT A/INPUT B: Terminals on the input card in SLOT 1
INPUT C/INPUT D: Terminals on the input card in SLOT 2
INPUT E/INPUT F: Terminals on the input card in SLOT 3
- **Compliant Video Signal** : NTSC (3.58 MHz)/PAL (4.43 MHz) (using the BT-YA701P)
480i/576i/480p/576p/1080i (50 Hz/60 Hz/24psF)/720p (50 Hz/60 Hz) (using the BT-YA702P)
D1 serial digital (using the BT-YA703P)
HD serial digital (using the BT-YA705G)

- **Remote Inputs** : • Point-of-contact connection, 1 line, D-sub connector (15-pin 3-line)
• Serial connection, 1 line, D-sub connector (9-pin), compliant to RS-232C
- **Audio Output** : 1 W (monaural)
- **Built-in Speaker** : 8 cm (3-1/4") round x 1
- **Environmental Conditions** : Operating temperature : 5°C – 35°C (41°F – 95°F)
Operating humidity : 20% – 80% (non-condensing)
- **Power Requirements** : 120 V AC, 50Hz/60 Hz
- **Power Consumption (when input card is inserted)** : 1.56 A (Max. 1.85 A)
- **Dimensions** : Width : 395 mm (15-5/8")
Height : 334 mm (13-1/4")
Depth : 466.5 mm (18-3/8") (not including wide mask and input card)
- **Weight** : 23.7 kg (52.1 lbs) (not including wide mask and input card)
- **Accessory** : AC power cord
Power cord holder x 1 (case and cover)
Screws x 2 (Power cord holder)
Wide Mask x 1
Screws x 4 (Wide Mask)

[Dimensions] Unit : mm (inch)

<Front View with the wide mask attached>

been
anatory purposes
ffer slightly.

inge without notice.

LCT1464-001A_EN_22-27-6 26

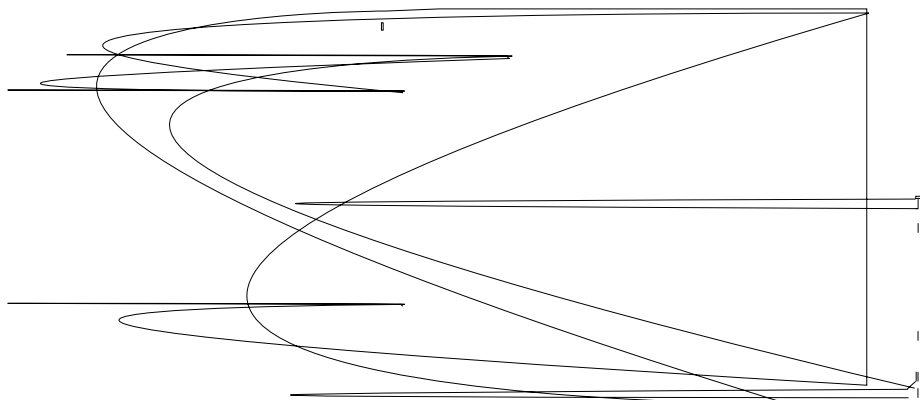

■ Compliant Signal Formats of Each Input Card

Input Signals	BT-YA701P	BT-YA702P	BT-YA703P	BT-YA705G
NTSC (3.58 MHz)	⊙	—	—	—
PAL (4.43 MHz)	⊙	—	—	—
Black-and-White (50 Hz/60 Hz)	⊙	—	—	—
480/60i (525i)	—	⊙	⊙	—
480/60p (525p)	—	⊙	—	—
576/50i	—	⊙	⊙	—
576/50p	—	⊙	—	—
720/50p (720p)	—	⊙	—	⊙
720/60p (720p)	—	⊙	—	⊙
1080/50i	—	⊙	—	⊙
1080/60i (1125i)	—	⊙	—	⊙
1035/60i (1125i) (*1)	—	○	—	○
1080/24psF	—	⊙	—	⊙
EMBEDDED AUDIO	—	—	—	⊙

⊙ : Input possible. Pre-set.

○ : Input possible. Not pre-set.

— : Input impossible

*1 : 1035/60i (1125i) is not pre-set. To input signals of these types, some setup adjustments are required.

Panasonic

PANASONIC BROADCAST & TELEVISION SYSTEMS COMPANY
UNIT COMPANY OF MATSUSHITA ELECTRIC CORPORATION OF AMERICA

Executive Office:

One Panasonic Way 4E-7, Secaucus, NJ 07094 (201) 348-7000

EASTERN ZONE:

One Panasonic Way 4E-7, Secaucus, NJ 07094 (201) 348-7621

Southeast Region:

1225 Northbrook Parkway, Ste 1-160, Suwanee, GA 30024 (770) 338-6835

Central Region:

1707 N Randall Road E1-C-1, Elgin, IL 60123 (847) 468-5200

WESTERN ZONE:

3330 Cahuenga Blvd W., Los Angeles, CA 90068 (323) 436-3500

Government Marketing Department:

52 West Gude Drive, Rockville, MD 20850 (301) 738-3840

Broadcast PARTS INFORMATION & ORDERING:

9:00 a.m. – 5:00 p.m. (EST) (800) 334-4881/24 Hr. Fax (800) 334-4880

Emergency after hour parts orders (800) 334-4881

TECHNICAL SUPPORT:

Emergency 24 Hour Service (800) 222-0741

Panasonic Canada Inc.

5770 Ambler Drive, Mississauga, Ontario L4W 2T3 (905) 624-5010

Panasonic de Mexico S.A. de C.V.

Av angel Urraza Num. 1209 Col. de Valle 03100 Mexico, D.F. (52) 1 951 2127

Panasonic Sales Company

Division of Matsushita Electric of Puerto Rico Inc.

San Gabriel Industrial Park, 65th Infantry Ave., Km. 9.5, Carolina, Puerto Rico 00630 (787) 750-4300