



POWER AMPLIFIER

IPA 8200

Owner's Manual
Bedienungsanleitung
Mode d'emploi
Manual de instrucciones
Manuale di istruzioni
Руководство пользователя

English

Deutsch

Français

Español

Italiano

Русский



EN
DE
FR
ES
IT
RU

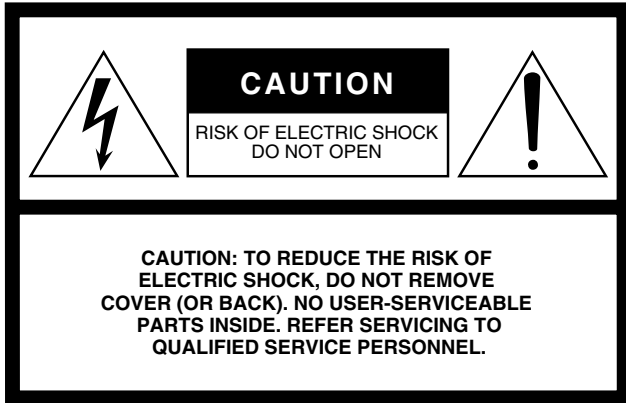

Explanation of Graphical Symbols

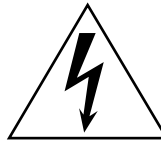

The lightning flash with arrowhead symbol within an equilateral triangle is intended to alert the user to the presence of uninsulated “dangerous voltage” within the product’s enclosure that may be of sufficient magnitude to constitute a risk of electric shock to persons.



The exclamation point within an equilateral triangle is intended to alert the user to the presence of important operating and maintenance (servicing) instructions in the literature accompanying the product.

The above warning is located on the top of the unit.

IMPORTANT SAFETY INSTRUCTIONS

- 1 Read these instructions.
- 2 Keep these instructions.
- 3 Heed all warnings.
- 4 Follow all instructions.
- 5 Do not use this apparatus near water.
- 6 Clean only with dry cloth.
- 7 Do not block any ventilation openings. Install in accordance with the manufacturer’s instructions.
- 8 Do not install near any heat sources such as radiators, heat registers, stoves, or other apparatus (including amplifiers) that produce heat.
- 9 Do not defeat the safety purpose of the polarized or grounding-type plug. A polarized plug has two blades with one wider than the other. A grounding type plug has two blades and a third grounding prong. The wide blade or the third prong are provided for your safety. If the provided plug does not fit into your outlet, consult an electrician for replacement of the obsolete outlet.
- 10 Protect the power cord from being walked on or pinched particularly at plugs, convenience receptacles, and the point where they exit from the apparatus.
- 11 Only use attachments/accessories specified by the manufacturer.
- 12 Use only with the cart, stand, tripod, bracket, or table specified by the manufacturer, or sold with the apparatus. When a cart is used, use caution when moving the cart/apparatus combination to avoid injury from tip-over.
- 13 Unplug this apparatus during lightning storms or when unused for long periods of time.
- 14 Refer all servicing to qualified service personnel. Servicing is required when the apparatus has been damaged in any way, such as power-supply cord or plug is damaged, liquid has been spilled or objects have fallen into the apparatus, the apparatus has been exposed to rain or moisture, does not operate normally, or has been dropped.



WARNING

TO REDUCE THE RISK OF FIRE OR ELECTRIC SHOCK, DO NOT EXPOSE THIS APPARATUS TO RAIN OR MOISTURE.

(UL60065_03)

FCC INFORMATION (U.S.A.)

1. IMPORTANT NOTICE: DO NOT MODIFY THIS UNIT!

This product, when installed as indicated in the instructions contained in this manual, meets FCC requirements. Modifications not expressly approved by Yamaha may void your authority, granted by the FCC, to use the product.

2. **IMPORTANT:** When connecting this product to accessories and/or another product use only high quality shielded cables. Cable/s supplied with this product **MUST** be used. Follow all installation instructions. Failure to follow instructions could void your FCC authorization to use this product in the USA.

* This applies only to products distributed by YAMAHA CORPORATION OF AMERICA.

(oscillator)

In Finland: Laite on liitettävä suojamaadoituskoskettimilla varustettuun pistorasiaan.

In Norway: Apparatet må tilkoples jordet stikkontakt.

In Sweden: Apparatens skall anslutas till jordat uttag.

(class1_hokuo)

PRECAUTIONS

PLEASE READ CAREFULLY BEFORE PROCEEDING

* Please keep this manual in a safe place for future reference.



WARNING

Always follow the basic precautions listed below to avoid the possibility of serious injury or even death from electrical shock, short-circuiting, damages, fire or other hazards. These precautions include, but are not limited to, the following:

Power supply/Power cord

- Only use the voltage specified as correct for the device. The required voltage is printed on the name plate of the device.
- Use only the included power cord.
If you intend to use the device in an area other than in the one you purchased, the included power cord may not be compatible. Please check with your Yamaha dealer.
- Do not place the power cord near heat sources such as heaters or radiators, and do not excessively bend or otherwise damage the cord, place heavy objects on it, or place it in a position where anyone could walk on, trip over, or roll anything over it.
- Be sure to connect to an appropriate outlet with a protective grounding connection. Improper grounding can result in electrical shock.

Do not open

- Do not open the device or attempt to disassemble the internal parts or modify them in any way. The device contains no user-serviceable parts. If it should appear to be malfunctioning, discontinue use immediately and have it inspected by qualified Yamaha service personnel.

Water warning

- Do not expose the device to rain, use it near water or in damp or wet conditions, or place containers on it containing liquids which might spill into any openings. If any liquid such as water seeps into the device, turn off the power immediately and unplug the power cord from the AC outlet. Then have the device inspected by qualified Yamaha service personnel.
- Never insert or remove an electric plug with wet hands.

If you notice any abnormality

- If the power cord or plug becomes frayed or damaged, or if there is a sudden loss of sound during use of the device, or if any unusual smells or smoke should appear to be caused by it, immediately turn off the power switch, disconnect the electric plug from the outlet, and have the device inspected by qualified Yamaha service personnel.
- If this device should be dropped or damaged, immediately turn off the power switch, disconnect the electric plug from the outlet, and have the device inspected by qualified Yamaha service personnel.



CAUTION

Always follow the basic precautions listed below to avoid the possibility of physical injury to you or others, or damage to the device or other property. These precautions include, but are not limited to, the following:

Power supply/Power cord

- Remove the electric plug from the outlet when the device is not to be used for extended periods of time, or during electrical storms.
- When removing the electric plug from the device or an outlet, always hold the plug itself and not the cord. Pulling by the cord can damage it.

Location

- Before moving the device, remove all connected cables.
- When setting up the device, make sure that the AC outlet you are using is easily accessible. If some trouble or malfunction occurs, immediately turn off the power switch and disconnect the plug from the outlet. Even when the power switch is turned off, electricity is still flowing to the product at the minimum level. When you are not using the product for a long time, make sure to unplug the power cord from the wall AC outlet.
- If the device is mounted in an EIA standard rack, carefully read the section "Precautions when rack-mounting the unit" on page 5. Inadequate ventilation can result in overheating, possibly causing damage to the device(s), malfunction, or even fire.

- Do not use the device in a confined, poorly-ventilated location. Make sure that there is adequate space between the device and surrounding walls or other devices: at least 5cm at the sides, 10cm behind and 10cm above. Inadequate ventilation can result in overheating, possibly causing damage to the device(s), or even fire.
- Do not expose the device to excessive dust or vibrations, or extreme cold or heat (such as in direct sunlight, near a heater, or in a car during the day) to prevent the possibility of panel disfiguration or damage to the internal components.
- Do not place the device in an unstable position where it might accidentally fall over.
- Do not block the vents. This device has ventilation holes at the front and rear to prevent the internal temperature from becoming too high. In particular, do not place the device on its side or upside down. Inadequate ventilation can result in overheating, possibly causing damage to the device(s), or even fire.
- Do not use the device in the vicinity of a TV, radio, stereo equipment, mobile phone, or other electric devices. Doing so may result in noise, both in the device itself and in the TV or radio next to it.
- Do not place the device in a location where it may come into contact with corrosive gases or salt air. Doing so may result in malfunction.

Connections

- Before connecting the device to other devices, turn off the power for all devices. Before turning the power on or off for all devices, set all volume levels to minimum.
- Turn off the power before connecting speakers, and use only the speaker cables for connecting speakers to the speaker jacks. Failure to do so can result in fire or electrical shock.

Handling caution

- When turning on the AC power in your audio system, always turn on the device LAST, to avoid speaker damage. When turning the power off, the device should be turned off FIRST for the same reason.
- Condensation can occur in the device due to rapid, drastic changes in ambient temperature – when the device is moved from one location to another, or airconditioning is turned on or off, for example. Using the device while condensation is present can cause damage. If there is reason to believe that

condensation might have occurred, leave the device for several hours without turning on the power until the condensation has completely dried out.

- Do not insert your fingers or hands in any gaps or openings on the device (vents).
- Avoid inserting or dropping foreign objects (paper, plastic, metal, etc.) into any gaps or openings on the device (vents) If this happens, turn off the power immediately and unplug the power cord from the AC outlet. Then have the device inspected by qualified Yamaha service personnel.
- Do not use speakers for a long period of time at a high or uncomfortable volume level, since this can cause permanent hearing loss. If you experience any hearing loss or ringing in the ears, consult a physician.
- Do not rest your weight on the device or place heavy objects on it, and avoid use excessive force on the buttons, switches or connectors.
- Do not use this device for any purpose other than driving loudspeakers.

Yamaha cannot be held responsible for damage caused by improper use or modifications to the device, or data that is lost or destroyed.

Always turn the power off when the device is not in use.

The performance of components with moving contacts, such as switches, volume controls, and connectors, deteriorates over time. Consult qualified Yamaha service personnel about replacing defective components.

European models

Purchaser/User Information specified in EN55103-1 and EN55103-2.

Inrush Current: 26A

Conforms to Environments: E1, E2, E3 and E4

* Specifications and descriptions in this owner's manual are for information purposes only. Yamaha Corp. reserves the right to change or modify products or specifications at any time without prior notice. Since specifications, equipment or options may not be the same in every locale, please check with your Yamaha dealer.

IMPORTANT NOTICE FOR THE UNITED KINGDOM

Connecting the Plug and Cord

WARNING: THIS APPARATUS MUST BE EARTHED

IMPORTANT. The wires in this mains lead are coloured in accordance with the following code:

GREEN-AND-YELLOW	: EARTH
BLUE	: NEUTRAL
BROWN	: LIVE

As the colours of the wires in the mains lead of this apparatus may not correspond with the coloured markings identifying the terminals in your plug proceed as follows:

The wire which is coloured GREEN-and-YELLOW must be connected to the terminal in the plug which is marked by the letter E or by the safety earth symbol \oplus or colored GREEN or GREEN-and-YELLOW.

The wire which is coloured BLUE must be connected to the terminal which is marked with the letter N or coloured BLACK.

The wire which is coloured BROWN must be connected to the terminal which is marked with the letter L or coloured RED.

• This applies only to products distributed by Yamaha Music U.K. Ltd.

(3 wires)

Introduction

Thank you for purchasing the Yamaha IPA8200 power amplifier.

In order to take full advantage of the IPA8200's functionality and to ensure trouble-free operation, please read this owner's manual carefully before use.

After you have read the manual, keep it in a safe place for reference when needed.

Features

- **Space-saving high-efficiency multi-channel 200W @ 4Ω x 8 power amplifier**
- **Switchable between STEREO/PARALLEL/BRIDGE modes as needed for your application**
- **Euroblock input jacks and barrier strip output jacks for easy installation**
- **High-pass filter with switchable cutoff frequency (20 Hz / 55 Hz)**
- **Input sensitivity / gain select switch switchable between three positions (+4 dBu, 26 dB, 32 dB)**

Precautions when rack-mounting the unit

Operation of this device is guaranteed for an environmental temperature range of 0 – 40°C. If you are mounting only this device in an EIA standard rack, you may mount multiple units without leaving a space between them. If you are mounting this device along with other types of device in an EIA standard rack, the ambient temperature inside the rack may rise due to heat produced from the other devices, preventing this device from performing as designed. To ensure that heat does not build up inside this device, you must observe the following conditions when mounting it in a rack.

- If you mount this device in a rack together with heat-generating devices such as power amps made by other companies, you must leave 1U or more space between this device and other devices. You should also install a ventilation panel in this space or leave it open to ensure adequate ventilation.
- Leave the back of the rack open, and allow 10 cm or more distance between the rack and the wall or ceiling to ensure adequate ventilation. If you are unable to leave the back of the rack open, you must install a commercially available fan kit or other forced air circulating system to the rack. If you have installed a fan kit, there may be cases in which closing the back of the rack will provide better cooling. For details, refer to the instructions that came with the rack system or fan kit.

Contents

Introduction	5
Features	5
Precautions when rack-mounting the unit	5
Controls and Functions	7
Front Panel	7
Rear Panel.....	8
Mode settings	9
STEREO mode.....	9
PARALLEL mode	9
BRIDGE mode.....	9
Connections	10
Input jack connections (Euroblock).....	10
Speaker connections (barrier strip)	10
Troubleshooting	11
Specifications	57
General Specifications.....	57
Block Diagram	58
Dimensions.....	58
Current Draw	59

Accessories (Please make sure the following items are included in the package.)

- IPA8200 Owner's Manual (this document)
- Power cable (2.5 m) x 1
- Security cover x 1
- Allen wrench x 1
- Security cover attachment screws x 2
- Euroblock plug (3P) x 8

Controls and Functions

Front Panel

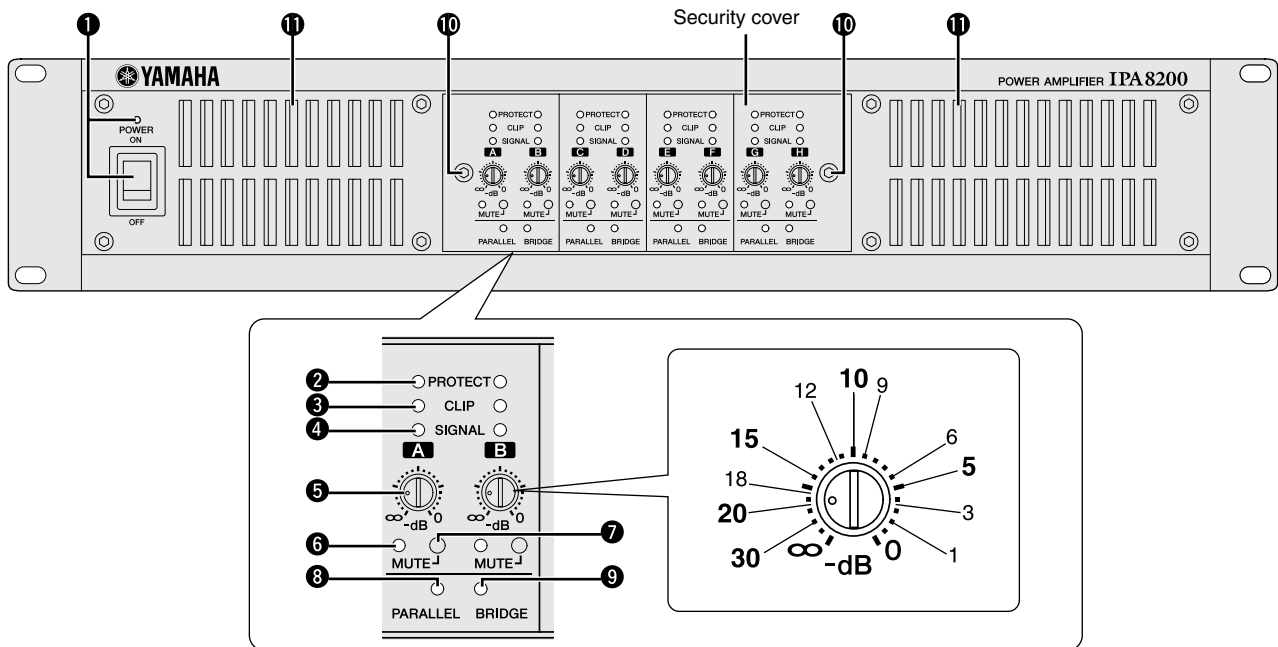

1 POWER switch and indicator

Turns power to the unit on or off. The indicator lights green when the power is on.

2 PROTECT indicator

When the protection system is active, the indicator lights red. When this is lit, the amplifier or power supply is automatically shut down, and no sound will be output from the speakers.

3 CLIP indicator

This indicator will light red when the output power exceeds 100 W for an 8Ω load or 200 W for a 4Ω load. When this is lit, the limiter will automatically operate.

4 SIGNAL indicator

This indicator will light green when the output level exceeds 2 Vrms. (This will light at 0.5 W or greater for an 8Ω load, 1 W or greater for a 4Ω load.)

5 Attenuator

These are detented knobs that attenuate the input signal of each channel (A–H) over 41 steps in a range of 0 dB – ∞ dB.

NOTE • To operate these knobs, use a slotted screwdriver with a blade no wider than 5.5 mm.

6 MUTE indicator

This will light red when mute is activated.

7 MUTE switch

This turns muting on/off for each channel. Use a thin rod to turn muting on/off.

8 PARALLEL indicator

This will light orange when the rear panel MODE switch is set to PARALLEL.

9 BRIDGE indicator

This will light orange when the rear panel MODE switch is set to BRIDGE.

10 Screw holes for security cover

If desired, you can use these two screw holes for attaching the included security cover to prevent the attenuator setting from being changed. Use the included Allen wrench and screws to attach the cover.

11 Air intakes

The amplifier uses forced-air cooling. The variable speed cooling fan draws air in from the front and exhausts it through the rear. The cooling fan operates at low speed when the heat sink temperature is below 65 °C (149 °F), or at high speed when the temperature exceeds 65 °C (140 °F). Please be sure that you do not block the air intakes or exhaust vents.

Rear Panel

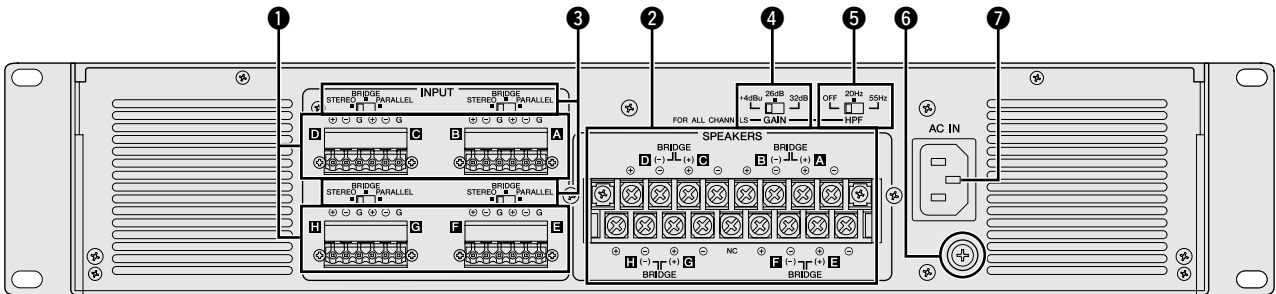

1 INPUT connectors

These are balanced input connectors. The included Euroblock connectors can be used to make connections here.

2 SPEAKERS connectors

These are barrier strip type speaker output connectors.

- NOTE**
- If using BRIDGE mode, connect the speakers to the “+” pin of channels A/C/E/G and the “-” pin of channels B/D/F/H.
 - Do not connect the pin marked NC located in the center of the bottom row of the barrier strip connectors.

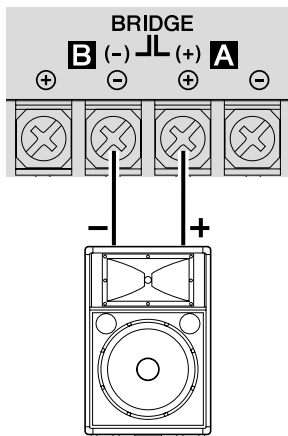

3 MODE switches

These specify the amplifier’s operation mode for each two channels.

- **STEREO mode**
Each channel (A–H) will operate independently.
- **BRIDGE mode**
The amplifiers will be bridged for pairs of adjacent channels (A-B, C-D, E-F, G-H), obtaining a high-power output.
- **PARALLEL mode**
The input signals will be input to the adjacent channels (A-B, C-D, E-F, G-H) as well.

4 GAIN switch

This switches the input sensitivity / gain for all channels together.

- **+4 dBu:** Sets the input sensitivity to +4 dBu.
- **26 dB:** Sets the gain to 26 dB.
- **32 dB:** Sets the gain to 32 dB.

5 HPF switch

Turns the high pass filter (20 Hz or 55 Hz) on/off. If this is set to 20 Hz or 55 Hz, the frequency components below that frequency will be cut by a 12 dB/oct. filter.

6 Ground screw

Hum and interference may be reduced in some cases by connecting the screw to an ground or to the chassis of the mixer, preamp, or other device in your system.

7 AC inlet

Connect this to the socket end of the included AC power cable . Connect the plug end of the AC power cable to an AC outlet of the correct voltage.



- If this device is to be rack mounted and transported frequently, be sure to support the rear end of the unit with mounting hardware that matches the size of the rack used.

Mode settings

Speakers can be connected to the IPA8200 using the following three mode settings. The total load impedance of the speakers that can be connected will depend on the mode setting. Do not use a setup that has a lower impedance than the minimum values shown below.

STEREO mode

If the rear panel MODE switch is set to STEREO, each channel will operate independently. You can use the front panel attenuators to adjust the attenuation for each channel independently.

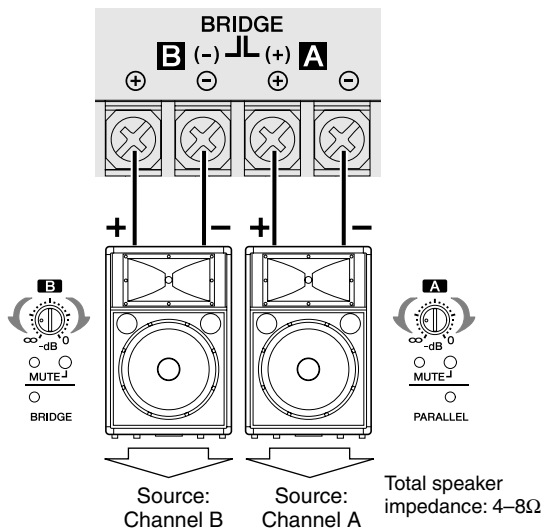

NOTE • Total speaker impedance must be 4–8Ω.

PARALLEL mode

If the rear panel MODE switch is set to PARALLEL, the input signals will be input to the adjacent channels (A-B, C-D, E-F, G-H) as well. Either of adjacent two channels can be used as an input connector. You can use the front panel attenuators to adjust the attenuation for each channel independently.

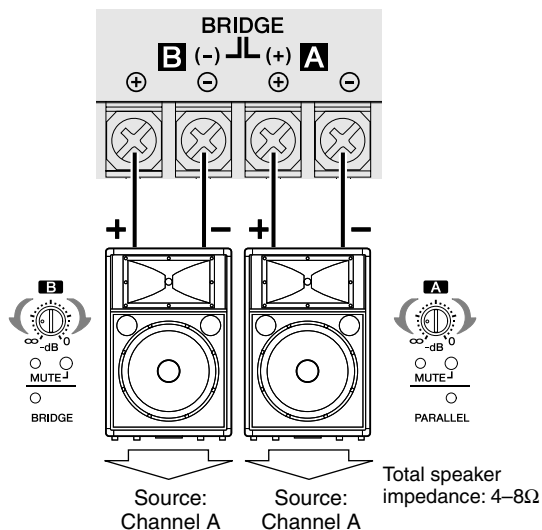

NOTE • Total speaker impedance must be 4–8Ω.

BRIDGE mode

If the rear panel MODE switch is set to BRIDGE, the amplifiers will be bridged between adjacent pairs of channels (A-B, C-D, E-F, G-H), and the IPA8200 will operate as a high-power amplifier. Either of adjacent two channels can be used as an input connector. Use the front panel channel A/C/E/G attenuators to adjust the attenuation.

- NOTE**
- If using BRIDGE mode, connect the speakers to the “+” pin of channels A/C/E/G and the “-” pin of channels B/D/F/H.
 - Total speaker impedance must be 8–16Ω.

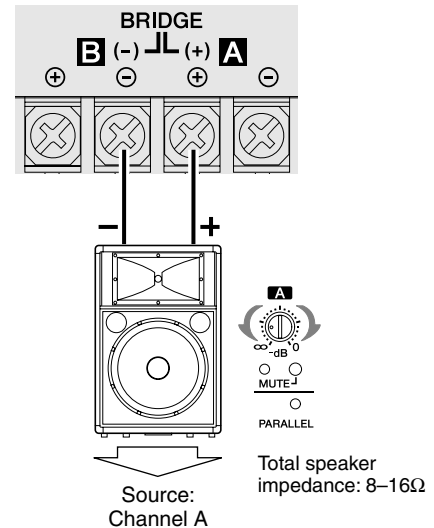

Connections

Input jack connections (Euroblock)

Please be sure to use the supplied Euroblock connectors. If you lose them, contact your nearest Yamaha dealer.

● Cable preparation

- To prepare the cable for attachment to a Euroblock connector, strip the wire as shown in the illustration, and use stranded wire to make connections. With a Euroblock connection, the stranded wire may be prone to breakage because of metal fatigue due to the weight of the cable or due to vibration. When rack-mounting your equipment, use a lacing bar when possible to bundle and fasten the cables.

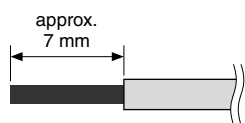

- If cables will be frequently connected and disconnected, as in the case of a portable installation, we recommend that you use ferrules with insulation sleeves. Use a ferrule whose conductor portion has an external diameter of 1.6 mm or less, and a length of approximately 7 mm (such as the A10, 5-6WH made by the Phoenix Contact corporation).

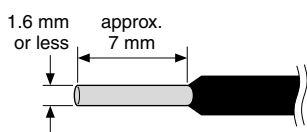

- If you use stranded wire, do not tin (plate with solder) the exposed end.

- If the wire insertion ports are closed, turn the screws on top of the connector counterclockwise to open the ports.
- Insert the wires into the appropriate ports, following the indication of the pole on the input terminal, and turn the screws on top of the connector clockwise to fasten the wires.
- Connect the Euroblock connector to the IPA8200's input jack.

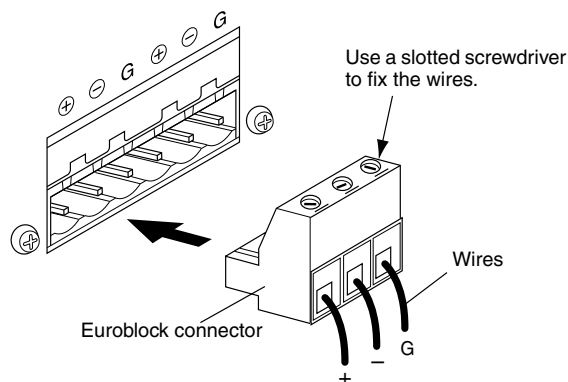

Speaker connections (barrier strip)

If using a spade lug

From below, insert the spade lug all the way, and tighten the screw.

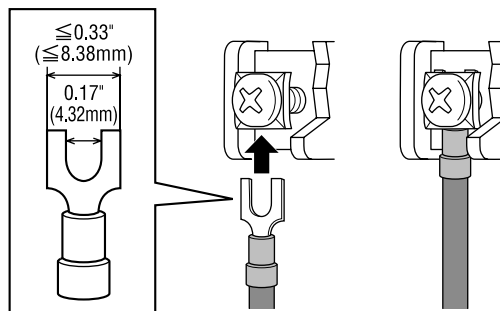

If using a bare conductor

Wrap the conductor around the barrier strip terminal as shown below, and tighten the screw. Be sure that the bare wire does not touch the chassis.

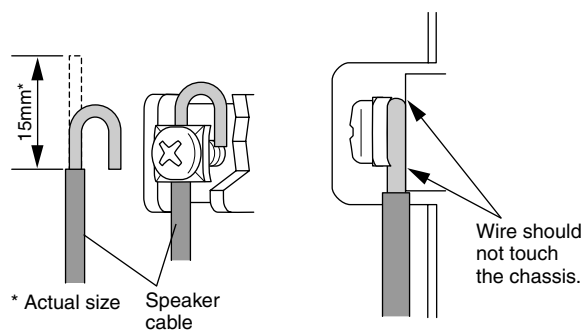

- NOTE**
- Do not connect the pin marked NC located in the center of the bottom row of the barrier strip connectors.
 - If using BRIDGE mode, connect the speakers to the "+" pin of channels A/C/E/G and the "-" pin of channels B/D/F/H.

Troubleshooting

Indicator(s)	Possible cause	Remedy	Protection circuit
CLIP indicator is lit.	Output exceeds 100 W (8Ω) or 200 W (4Ω).	Lower the input level.	Limiter circuit will operate to protect the power amp and power supply.
PROTECT indicator is lit.	Speaker output connector is shorted.	Check whether the speaker output connector or speaker cable could be shorted, and then power-cycle the IPA8200. If the PROTECT indicator is still lit, contact your Yamaha dealer.	The protection circuit will operate to protect the power amp and power supply.
	The power amp section's heat sink temperature has exceeded 95°C or the power supply section's heat sink temperature has exceeded 85°C.	Check whether there might be blockage at the air intake or a ventilation problem inside the rack, and verify that the load impedance of the connected speakers is not below the rated value (4Ω or 8Ω/ BRIDGE). Then wait until the unit's temperature has dropped, and power-cycle the unit. If the PROTECT indicator is still lit, contact your Yamaha dealer.	The protection circuit will operate to protect the power amp.
	A DC offset voltage is being output to the speaker output connector.	Consult your Yamaha dealer.	The protection circuit will operate to protect the speakers.

Specifications

General Specifications

Output Power	4Ω per channel	200W x 8		
	8Ω per channel	100W x 8		
	8Ω / BRIDGE	400W x 4		
1kHz, THD+N=1%	4Ω per channel	180W x 8		
	8Ω per channel	90W x 8		
	8Ω / BRIDGE	360W x 4		
20Hz-20kHz, THD+N=1%	4Ω per channel	200W x 8		
	8Ω per channel	100W x 8		
	8Ω / BRIDGE	400W x 4		
1kHz, 20ms Burst	4Ω per channel	200W x 8		
	8Ω per channel	100W x 8		
	8Ω / BRIDGE	400W x 4		
Maximum Input Level	+24dBu			
Input Impedance	20kΩ(balanced), 10kΩ(unbalanced)			
Input Sensitivity (dBu)	Switch Position	+4dBu	26dB	32dB
	8Ω, Att. max	Input sensitivity	+4dBu	+5.2dBu
Voltage Gain	Switch Position	+4dBu	26dB	32dB
	Att. Max	Voltage Gain	27.2dB	26dB
S/N Ratio	A-weighted	≥100dB		
THD+N	1kHz, half power, 4Ω	≤0.5%		
Frequency Response	1W, 8Ω	20Hz-20kHz, +0dB, -1.5dB		
Channel Separation	1kHz, half power, 8Ω Att. max, input 600Ω shunt	≥60dB		
Controls	Front Panel	POWER switch (rocker) MUTE switch (push ON/push OFF) x 8 Attenuator (41position) x 8		
	Rear Panel	MODE switch (STEREO/BRIDGE/PARALLEL) x 4 GAIN switch (+4dBu/26dB/32dB) x 1 HPF switch (OFF/20Hz/55Hz) x 1		
Connectors	Input	Euroblock (balanced)/ch		
	Output	Barrier strip/ch		
	Power	AC inlet x 1		
Indicators	POWER x 1 (Green), PROTECT x 8 (Red), CLIP x 8 (Red), SIGNAL x 8 (Green), MUTE x 8 (Red), PARALLEL x 4 (Orange), BRIDGE x 4 (Orange)			
Load Protection	POWER switch on/off	Output mute		
	DC-fault	Power supply shutdown		
Amplifier Protection	Thermal	Output mute (heatsink temp ≥95°C)		
	Over current	Power supply shutdown		
Power Supply Protection	Thermal	Power supply shutdown (heatsink temp ≥85°C)		
Limiter Circuit	Clip limiting	Limiting level ≥100W@8Ω or 200W@4Ω		
Cooling	High/Low two speed fan x 2			
AC Power Requirement	U.S./Canada: 120V, 60Hz Korea: 220V, 60Hz China: 220V, 50Hz Other: 220V-240V, 50/60Hz			
Power Consumption	400W			
Dimensions (W x H x D)	480 x 88 x 406.5mm (18-7/8 x 3-7/16 x 16 inch) (The depth is measured from the front panel surface to the rear mounting hardware.)			
Weight	10.5kg (23.2 lbs)			
Included Accessories	AC power cord (2.5m) x 1, Security cover x 1, Allen wrench x 1, Security cover attachment screw x 2, 3-pin Euroblock connector x 8, Owner's manual			

- Half power = 3dB below rated power
- 0dBu = 0.775Vrms

Block Diagram

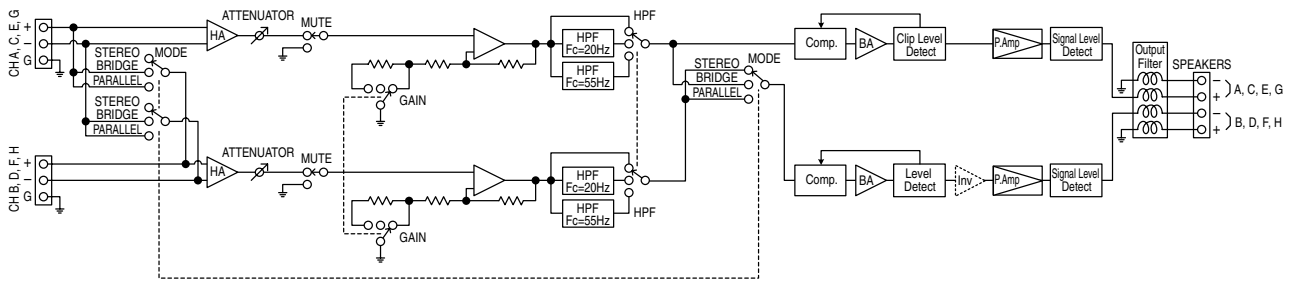

Dimensions

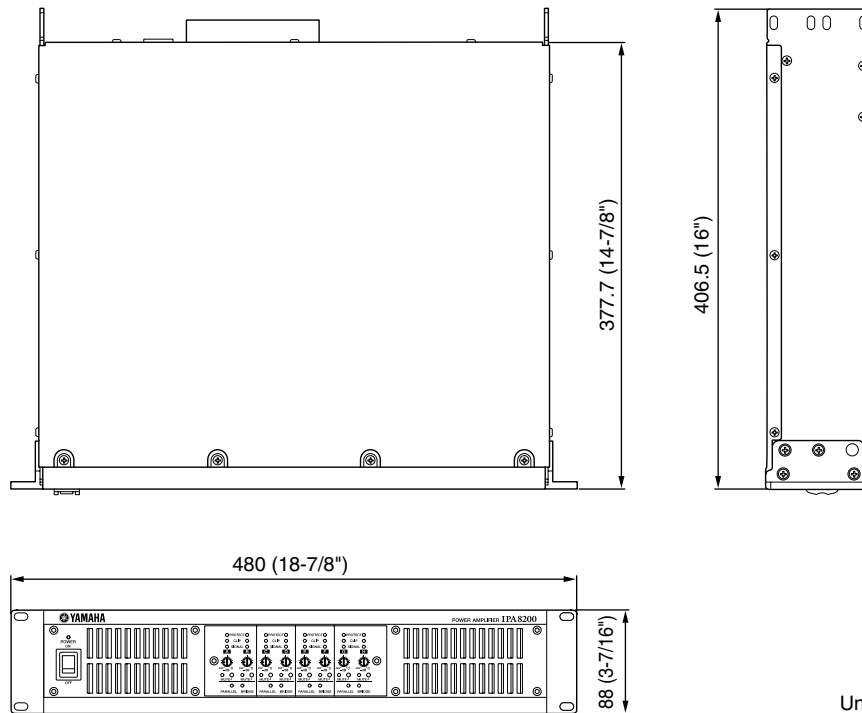

Unit: mm (inch)

Current Draw

		Line Current (A)		Power (W)			Thermal Dissipation	
		100/120V	230/240V	In	Out	Dissipated	Btu/h	kcal/h
Idle		0.8	0.4	69	0	69	235	59
1/8 power	8Ω/ch	1.9	1.0	189	100	89	304	77
	4Ω/ch	3.3	1.5	327	200	127	433	109
1/3 power	8Ω/ch	3.9	1.8	389	267	122	417	105
	4Ω/ch	7.7	3.3	774	533	241	821	207

1/8 power is typical of program material with occasional clipping. Refer to these figures for most applications.

1/3 power represents program material with extremely heavy clipping.

Test signal: Pink Noise, bandwidth limited from 22Hz to 22kHz

1W = 0.860kcal/h, 1BTU = 0.252kcal

Note that Line Voltage [V] x Line Current [A] = [VA], not equals to [W].

Inrush current: 11A (100V), 13A (120V), 26A (240V)

MEMO

EN

Information for Users on Collection and Disposal of Old Equipment

This symbol on the products, packaging, and/or accompanying documents means that used electrical and electronic products should not be mixed with general household waste.

For proper treatment, recovery and recycling of old products, please take them to applicable collection points, in accordance with your national legislation and the Directives 2002/96/EC.

By disposing of these products correctly, you will help to save valuable resources and prevent any potential negative effects on human health and the environment which could otherwise arise from inappropriate waste handling.

For more information about collection and recycling of old products, please contact your local municipality, your waste disposal service or the point of sale where you purchased the items.

[For business users in the European Union]

If you wish to discard electrical and electronic equipment, please contact your dealer or supplier for further information.

[Information on Disposal in other Countries outside the European Union]

This symbol is only valid in the European Union. If you wish to discard these items, please contact your local authorities or dealer and ask for the correct method of disposal.

DE

Verbraucherinformation zur Sammlung und Entsorgung alter Elektrogeräte

Befindet sich dieses Symbol auf den Produkten, der Verpackung und/oder beiliegenden Unterlagen, so sollten benutzte elektrische Geräte nicht mit dem normalen Haushaltsabfall entsorgt werden.

In Übereinstimmung mit Ihren nationalen Bestimmungen und den Richtlinien 2002/96/EC, bringen Sie alte Geräte bitte zur fachgerechten Entsorgung, Wiederaufbereitung und Wiederverwendung zu den entsprechenden Sammelstellen.

Durch die fachgerechte Entsorgung der Elektrogeräte helfen Sie, wertvolle Ressourcen zu schützen und verhindern mögliche negative Auswirkungen auf die menschliche Gesundheit und die Umwelt, die andernfalls durch unsachgerechte Müllentsorgung auftreten könnten.

Für weitere Informationen zum Sammeln und Wiederaufbereiten alter Elektrogeräte, kontaktieren Sie bitte Ihre örtliche Stadt- oder Gemeindeverwaltung, Ihren Abfallentsorgungsdienst oder die Verkaufsstelle der Artikel.

[Information für geschäftliche Anwender in der Europäischen Union]

Wenn Sie Elektrogeräte ausrangieren möchten, kontaktieren Sie bitte Ihren Händler oder Zulieferer für weitere Informationen.

[Entsorgungsinformation für Länder außerhalb der Europäischen Union]

Dieses Symbol gilt nur innerhalb der Europäischen Union. Wenn Sie solche Artikel ausrangieren möchten, kontaktieren Sie bitte Ihre örtlichen Behörden oder Ihren Händler und fragen Sie nach der sachgerechten Entsorgungsmethode.

FR

Information concernant la Collecte et le Traitement des déchets d'équipements électriques et électroniques

Le symbole sur les produits, l'emballage et/ou les documents joints signifie que les produits électriques ou électroniques usagés ne doivent pas être mélangés avec les déchets domestiques habituels.

Pour un traitement, une récupération et un recyclage appropriés des déchets d'équipements électriques et électroniques, veuillez les déposer aux points de collecte prévus à cet effet, conformément à la réglementation nationale et aux Directives 2002/96/EC.

En vous débarrassant correctement des déchets d'équipements électriques et électroniques, vous contribuerez à la sauvegarde de précieuses ressources et à la prévention de potentiels effets négatifs sur la santé humaine qui pourraient advenir lors d'un traitement inapproprié des déchets.

Pour plus d'informations à propos de la collecte et du recyclage des déchets d'équipements électriques et électroniques, veuillez contacter votre municipalité, votre service de traitement des déchets ou le point de vente où vous avez acheté les produits.

[Pour les professionnels dans l'Union Européenne]

Si vous souhaitez vous débarrasser des déchets d'équipements électriques et électroniques veuillez contacter votre vendeur ou fournisseur pour plus d'informations.

[Information sur le traitement dans d'autres pays en dehors de l'Union Européenne]

Ce symbole est seulement valable dans l'Union Européenne. Si vous souhaitez vous débarrasser de déchets d'équipements électriques et électroniques, veuillez contacter les autorités locales ou votre fournisseur et demander la méthode de traitement appropriée.

ES

Información para Usuarios sobre Recolección y Disposición de Equipamiento Viejo

Este símbolo en los productos, embalaje, y/o documentación que se acompañe significa que los productos electrónicos y eléctricos usados no deben ser mezclados con desechos hogareños corrientes.

Para el tratamiento, recuperación y reciclado apropiado de los productos viejos, por favor llévelos a puntos de recolección aplicables, de acuerdo a su legislación nacional y las directivas 2002/96/EC.

Al disponer de estos productos correctamente, ayudará a ahorrar recursos valiosos y a prevenir cualquier potencial efecto negativo sobre la salud humana y el medio ambiente, el cual podría surgir de un inapropiado manejo de los desechos.

Para mayor información sobre recolección y reciclado de productos viejos, por favor contacte a su municipio local, su servicio de gestión de residuos o el punto de venta en el cual usted adquirió los artículos.

[Para usuarios de negocios en la Unión Europea]

Si usted desea deshacerse de equipamiento eléctrico y electrónico, por favor contacte a su vendedor o proveedor para mayor información.

[Información sobre la Disposición en otros países fuera de la Unión Europea]

Este símbolo sólo es válido en la Unión Europea. Si desea deshacerse de estos artículos, por favor contacte a sus autoridades locales y pregunte por el método correcto de disposición.

IT

Informazioni per gli utenti sulla raccolta e lo smaltimento di vecchia attrezzatura

Questo simbolo sui prodotti, sull'imballaggio, e/o sui documenti che li accompagnano significa che i prodotti elettriche e elettroniche non dovrebbero essere mischiati con i rifiuti domestici generici.

Per il trattamento, recupero e riciclaggio appropriati di vecchi prodotti, li porti, prego, ai punti di raccolta appropriati, in accordo con la Sua legislazione nazionale e le direttive 2002/96/CE.

Smaltendo correttamente questi prodotti, Lei aiuterà a salvare risorse preziose e a prevenire alcuni potenziali effetti negativi sulla salute umana e l'ambiente, che altrimenti potrebbero sorgere dal trattamento improprio dei rifiuti.

Per ulteriori informazioni sulla raccolta e il riciclaggio di vecchi prodotti, prego contatti la Sua amministrazione comunale locale, il Suo servizio di smaltimento dei rifiuti o il punto vendita dove Lei ha acquistato gli articoli.

[Per utenti imprenditori dell'Unione europea]

Se Lei desidera disfarsi di attrezzatura elettrica ed elettronica, prego contatti il Suo rivenditore o fornitore per ulteriori informazioni.

[Informazioni sullo smaltimento negli altri Paesi al di fuori dell'Unione europea]

Questo simbolo è valido solamente nell'Unione europea. Se Lei desidera disfarsi di questi articoli, prego contatti le Sue autorità locali o il rivenditore e richieda la corretta modalità di smaltimento.

For details of products, please contact your nearest Yamaha representative or the authorized distributor listed below.

Die Einzelheiten zu Produkten sind bei Ihrer unten aufgeführten Niederlassung und bei Yamaha Vertragshändlern in den jeweiligen Bestimmungsländern erhältlich.

Pour plus de détails sur les produits, veuillez-vous adresser à Yamaha ou au distributeur le plus proche de vous figurant dans la liste suivante.

Para detalles sobre productos, contacte su tienda Yamaha más cercana o el distribuidor autorizado que se lista debajo.

Per ulteriori dettagli sui prodotti, rivolgersi al più vicino rappresentante Yamaha oppure a uno dei distributori autorizzati elencati di seguito.

Подробные сведения об инструменте можно получить у местного представителя корпорации Yamaha или уполномоченного дистрибьютора, указанного в следующем списке.

NORTH AMERICA

CANADA

Yamaha Canada Music Ltd.
135 Milner Avenue, Scarborough, Ontario,
M1S 3R1, Canada
Tel: 416-298-1311

U.S.A.

Yamaha Corporation of America
6600 Orangethorpe Ave., Buena Park, Calif. 90620,
U.S.A.
Tel: 714-522-9011

CENTRAL & SOUTH AMERICA

MEXICO

Yamaha de México S.A. de C.V.
Calz. Javier Rojo Gómez #1149,
Col. Guadalupe del Moral
C.P. 09300, México, D.F., México
Tel: 55-5804-0600

BRAZIL

Yamaha Musical do Brasil Ltda.
Rua Joaquim Floriano, 913 - 4º andar, Itaim Bibi,
CEP 04534-013 Sao Paulo, SP. BRAZIL
Tel: 011-3704-1377

ARGENTINA

Yamaha Music Latin America, S.A.
Sucursal de Argentina
Olga Cossettini 1553, Piso 4 Norte
Madero Este-C1107CEK
Buenos Aires, Argentina
Tel: 011-4119-7000

PANAMA AND OTHER LATIN AMERICAN COUNTRIES/ CARIBBEAN COUNTRIES

Yamaha Music Latin America, S.A.
Torre Banco General, Piso 7, Urbanización Marbella,
Calle 47 y Aquilino de la Guardia,
Ciudad de Panamá, Panamá
Tel: +507-269-5311

EUROPE

THE UNITED KINGDOM

Yamaha Music U.K. Ltd.
Sherbourne Drive, Tilbrook, Milton Keynes,
MK7 8BL, England
Tel: 01908-366700

GERMANY

Yamaha Music Europe GmbH
Siemensstraße 22-34, 25462 Rellingen, Germany
Tel: 04101-3030

SWITZERLAND/LIECHTENSTEIN

Yamaha Music Europe GmbH
Branch Switzerland in Zürich
Seefeldstrasse 94, 8008 Zürich, Switzerland
Tel: 01-383 3990

AUSTRIA

Yamaha Music Europe GmbH Branch Austria
Schleiergasse 20, A-1100 Wien, Austria
Tel: 01-60203900

CZECH REPUBLIC/SLOVAKIA/ HUNGARY/SLOVENIA

Yamaha Music Europe GmbH Branch Austria
Schleiergasse 20, A-1100 Wien, Austria
Tel: 01-602039025

POLAND

Yamaha Music Europe GmbH
Branch Sp.z o.o. Oddział w Polsce
ul. 17 Stycznia 56, PL-02-146 Warszawa, Poland
Tel: 022-868-07-57

THE NETHERLANDS/ BELGIUM/LUXEMBOURG

Yamaha Music Europe Branch Benelux
Clarissenhof 5-b, 4133 AB Vianen, The Netherlands
Tel: 0347-358 040

FRANCE

Yamaha Musique France
BP 70-77312 Marne-la-Vallée Cedex 2, France
Tel: 01-64-61-4000

ITALY

Yamaha Musica Italia S.P.A.
Combo Division
Viale Italia 88, 20020 Lainate (Milano), Italy
Tel: 02-935-771

SPAIN/PORTUGAL

Yamaha Música Ibérica, S.A.
Ctra. de la Coruna km. 17, 200, 28230
Las Rozas (Madrid), Spain
Tel: 91-639-8888

SWEDEN

Yamaha Scandinavia AB
J. A. Wettergrens Gata 1, Box 30053
S-400 43 Göteborg, Sweden
Tel: 031 89 34 00

DENMARK

YS Copenhagen Liaison Office
Generatorvej 6A, DK-2730 Herlev, Denmark
Tel: 44 92 49 00

NORWAY

Norsk filial av Yamaha Scandinavia AB
Grini Næringspark 1, N-1345 Østerås, Norway
Tel: 67 16 77 70

RUSSIA

Yamaha Music (Russia)
Office 4015, entrance 2, 21/5 Kuznetskii
Most street, Moscow, 107996, Russia
Tel: 495 626 0660

OTHER EUROPEAN COUNTRIES

Yamaha Music Europe GmbH
Siemensstraße 22-34, 25462 Rellingen, Germany
Tel: +49-4101-3030

AFRICA

Yamaha Corporation,
Asia-Pacific Music Marketing Group
Nakazawa-cho 10-1, Naka-ku, Hamamatsu,
Japan 430-8650
Tel: +81-53-460-2313

MIDDLE EAST

TURKEY/CYPRUS

Yamaha Music Europe GmbH
Siemensstraße 22-34, 25462 Rellingen, Germany
Tel: 04101-3030

OTHER COUNTRIES

Yamaha Music Gulf FZE
LOB 16-513, P.O.Box 17328, Jubel Ali,
Dubai, United Arab Emirates
Tel: +971-4-881-5868

ASIA

THE PEOPLE'S REPUBLIC OF CHINA

Yamaha Music & Electronics (China) Co.,Ltd.
2F, Yunhedasha, 1818 Xinzha-lu, Jingan-qu,
Shanghai, China
Tel: 021-6247-2211

INDIA

Yamaha Music India Pvt. Ltd.
5F Ambience Corporate Tower Ambience Mall Complex
Ambience Island, NH-8, Gurgaon-122001, Haryana, India
Tel: 0124-466-5551

INDONESIA

PT. Yamaha Music Indonesia (Distributor)
PT. Nusantik
Gedung Yamaha Music Center, Jalan Jend. Gatot
Subroto Kav. 4, Jakarta 12930, Indonesia
Tel: 21-520-2577

KOREA

Yamaha Music Korea Ltd.
8F, 9F, Dongsung Bldg. 158-9 Samsung-Dong,
Kangnam-Gu, Seoul, Korea
Tel: 080-004-0022

MALAYSIA

Yamaha Music Malaysia, Sdn., Bhd.
Lot 8, Jalan Perbandaran, 47301 Kelana Jaya,
Petaling Jaya, Selangor, Malaysia
Tel: 3-78030900

SINGAPORE

Yamaha Music Asia Pte., Ltd.
#03-11 A-Z Building
140 Paya Lebor Road, Singapore 409015
Tel: 747-4374

TAIWAN

Yamaha KHS Music Co., Ltd.
3F, #6, Sec.2, Nan Jing E. Rd. Taipei.
Taiwan 104, R.O.C.
Tel: 02-2511-8688

THAILAND

Siam Music Yamaha Co., Ltd.
4, 6, 15 and 16th floor, Siam Motors Building,
891/1 Rama 1 Road, Wangmai,
Pathumwan, Bangkok 10330, Thailand
Tel: 02-215-2626

OTHER ASIAN COUNTRIES

Yamaha Corporation,
Asia-Pacific Music Marketing Group
Nakazawa-cho 10-1, Naka-ku, Hamamatsu,
Japan 430-8650
Tel: +81-53-460-2317

OCEANIA

AUSTRALIA

Yamaha Music Australia Pty. Ltd.
Level 1, 99 Queensbridge Street, Southbank,
Victoria 3006, Australia
Tel: 3-9693-5111

COUNTRIES AND TRUST TERRITORIES IN PACIFIC OCEAN

Yamaha Corporation,
Asia-Pacific Music Marketing Group
Nakazawa-cho 10-1, Naka-ku, Hamamatsu,
Japan 430-8650
Tel: +81-53-460-2313

HEAD OFFICE Yamaha Corporation, Pro Audio & Digital Musical Instrument Division
Nakazawa-cho 10-1, Naka-ku, Hamamatsu, Japan 430-8650
Tel: +81-53-460-2441



Yamaha Pro Audio global web site:
<http://www.yamahaproaudio.com/>

Yamaha Manual Library
<http://www.yamaha.co.jp/manual/>