

KY-F1030 Digital Camera

JVC[®]

**Digital Camera
Digitale Kamera
Caméra numérique**

**KY-F1030 INSTRUCTIONS
BEDIENUNGSANLEITUNG
MANUEL D'INSTRUCTIONS**

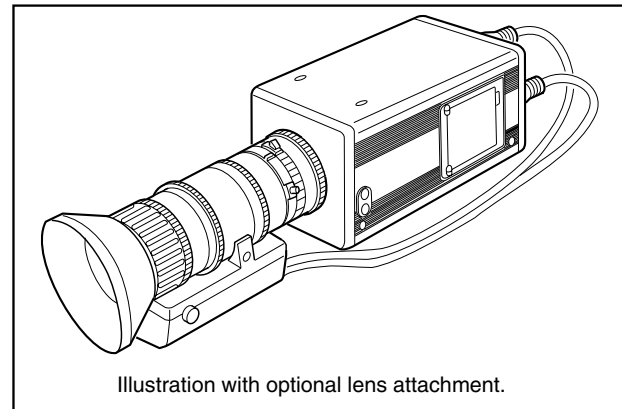

Introduction

Before recording

Settings and adjustments for recording

Various recording methods

Menu screen settings

Others

JVC[®]
VICTOR COMPANY OF JAPAN, LIMITED

JVC[®] is a registered trademark owned by VICTOR COMPANY OF JAPAN, LTD.
JVC[®] is a registered trademark in Japan, the U.S.A., the U.K. and many other countries.
© 2001 VICTOR COMPANY OF JAPAN, LIMITED

Printed in Japan
LWT0016

For Customer Use:
Enter below the Serial No. which is located on the unit. Retain this information for future reference.

Model No. **KY-F1030**

Serial No. _____

This instruction book is made from 100% recycled paper.

LWT0016

IMPORTANT SAFEGUARDS

1. Read all of these instructions.
2. Save these instructions for later use.
3. All warnings on the product and in the operating instructions should be adhered to.
4. Unplug this appliance system from the wall outlet before cleaning. Do not use liquid cleaners or aerosol cleaners. Use a damp cloth for cleaning.
5. Do not use attachments not recommended by the appliance manufacturer as they may cause hazards.
6. Do not use this appliance near water - for example, near a bathtub, washbowl, kitchen sink, or laundry tub, in a wet basement, or near a swimming pool, etc.
7. Do not place this appliance on an unstable cart, stand, or table. The appliance may fall, causing serious injury to a child or adult, and serious damage to the appliance.
Use only with a cart or stand recommended by the manufacturer, or sold with the appliance. Wall or shelf mounting should follow the manufacturer's instructions, and should use a mounting kit approved by the manufacturer. An appliance and cart combination should be moved with care.
Quick stops, excessive force, and uneven surfaces may cause the appliance and cart combination to overturn.
8. Slots and openings in the cabinet and the back or bottom are provided for ventilation, and to insure reliable operation of the appliance and to protect it from overheating, these openings must not be blocked or covered. The openings should never be blocked by placing the appliance on a bed, sofa, rug, or other similar surface.
This appliance should never be placed near or over a radiator or heat register. This appliance should not be placed in a built-in installation such as a bookcase unless proper ventilation is provided.
9. This appliance should be operated only from the type of power source indicated on the marking label. If you are not sure of the type of power supplied to your home, consult your dealer or local power company. For appliance designed to operate from battery power, refer to the operating instructions.
10. This appliance system is equipped with a 3-wire grounding type plug (a plug having a third (grounding) pin). This plug will only fit into a grounding-type power outlet. This is a safety feature. If you are unable to insert the plug into the outlet, contact your electrician to replace your obsolete outlet. Do not defeat the safety purpose of the grounding plug.
11. For added protection for this product during a lightning storm, or when it is left unattended and unused for long periods of time, unplug it from the wall outlet and disconnect the antenna or cable system. This will prevent damage to the product due to lightning and power-line surges.
12. Do not allow anything to rest on the power cord. Do not locate this appliance where the cord will be abused by persons walking on it.

PORTABLE CART WARNING
(symbol provided by RETAC)



S3126A

13. Follow all warnings and instructions marked on the appliance.
14. Do not overload wall outlets and extension cords as this can result in fire or electric shock.
15. Never push objects of any kind into his appliance through cabinet slots as they may touch dangerous voltage points or short out parts that could result in a fire or electric shock. Never spill liquid of any kind on the appliance.
16. Do not attempt to service this appliance yourself as opening or removing covers may expose you to dangerous voltage or other hazards. Refer all servicing to qualified service personnel.
17. Unplug his appliance from the wall outlet and refer servicing to qualified service personnel under following conditions:
 - a. When the power cord or plug is damaged or frayed.
 - b. If liquid has been spilled into the appliance.
 - c. If the appliance has been exposed to rain or water.
 - d. If the appliance does not operate normally by following the operating instructions. Adjust only those controls that are covered by the operating instructions as improper adjustment of other controls may result in damage and will often require extensive work by a qualified technician to restore the appliance to normal operation.
 - e. If the appliance has been dropped or the cabinet has been damaged.
 - f. When the appliance exhibits a distinct change in performance - this indicates a need for service.
18. When replacement parts are required, be sure the service technician has used replacement parts specified by the manufacturer that have the same characteristics as the original part. Unauthorized substitutions may result in fire, electric shock, or other hazards.
19. Upon completion of any service or repairs to this appliance, ask the service technician to perform routine safety checks to determine that the appliance is in safe operating condition.

JVC Sales Office

1. JVC PROFESSIONAL PRODUCTS (U.K.) LIMITED

ULLSWATER HOUSE, KENDAL AVENUE
LONDON, W3 0XA, UNITED KINGDOM
TEL : 020 8896 6000

2. JVC PROFESSIONAL PRODUCTS GMBH

GRÜENER WEG 12, 61169 FRIEDBERG / HESSEN GERMANY
TEL : (06031)6050

3. JVC PROFESSIONAL PRODUCTS ITALIA S.p.A.

VIA MARIO PANNUNZIO 4, 20156 MILANO, ITALY
TEL : (02)38.05.01

4. JVC FRANCE S.A.

1, AVENUE EIFFEL 78422 CARRIERES-SUR-SEINE, CEDEX FRANCE
TEL : 33.1.61.04.11.64.

5. JVC ESPAÑA S.A.

CTRA GRACIA MANRESA, KM 14 750 EDIFICIO CAN CASTANYER
08190 SANT CUGAT DEL VALLES (BARCELONA) SPAIN
TEL : (93)5653210

6. JVC BELGIUM S.A./N.V.

RUE DE LA PETITE LLE 3, KLEIN-EILANDSTRAAT,
BRUXELLES 1070 BRUSSEL, BELGIUM
TEL : (02)529-4211

7. JVC NEDERLAND B.V.

JVC PLEIN DE HEYDERWEG 2, 2314 XZ LEIDEN, NEDERLAND
TEL : (071)5453333

8. JVC SVENSKA AB

VEDDESTAVAGEN 15, S-175 62 JARFALLA-STOCKHOLM, SWEDEN
TEL : (08)7950400

9. JVC NORGE A/S

P.O.BOX 2012, POSTTERMINALEN 3103, TONSBERG, NORWAY
TEL : (333)61600

10. JVC DENMARK A/S

HELGESHOJ ALLE 30 DK-2630, TASTRUP, DENMARK
TEL : (43)509000

11. SPITZER ELECTRONIC AG

MUHLEMATTSTRASSE 13, 4104 OBERWIL, SWITZERLAND
TEL : 0614051111

12. OY HEDPRO AB

LAUTTASAARENTIE 50, FIN-00200 HELSINKI, FINLAND
TEL : 35896828244

13. ELECTROINDUSTRIAL HELLAS S.A.

62, PIRAEUS AVE, 183 46 MOSCHATO, ATHENS, GREECE
TEL : (01)4832855

14. ORIELA S.A.

CAMPO STA. CLARA 160-A, 1100 LISBOA PORTUGAL
TEL : 351-1-882-3382

15. FACO HF

FAXAFEN 12, P.O.BOX 442, 108 108 REYKJAVIK, ICELAND
TEL : 91-588-3050

Thank you for purchasing the JVC KY-F1030 Digital Camera.

These instructions are for KY-F1030U.

The instructions are given in three languages:

English from page E2 to E46

German from page G2 to G46

French from page F2 to F46

SAFETY PRECAUTIONS

FOR USA AND CANADA



CAUTION: TO REDUCE THE RISK OF ELECTRIC SHOCK, DO NOT REMOVE COVER (OR BACK). NO USER SERVICEABLE PARTS INSIDE. REFER SERVICING TO QUALIFIED SERVICE PERSONNEL.



The lightning flash with arrowhead symbol, within an equilateral triangle is intended to alert the user to the presence of uninsulated "dangerous voltage" within the product's enclosure that may be of sufficient magnitude to constitute a risk of electric shock to persons.



The exclamation point within an equilateral triangle is intended to alert the user to the presence of important operating and maintenance (servicing) instructions in the literature accompanying the appliance.

Information for USA

This device complies with Part 15 of the FCC Rules. Changes or modifications not approved by JVC could void the user's authority to operate the equipment.

INFORMATION (FOR CANADA) RENSEIGNEMENT (POUR CANADA)

- This Class B digital apparatus complies with Canadian ICES-003.
- Cet appareil numérique de la classe B est conforme à la norme NMB-003 du Canada.

Changes or modifications not approved by JVC could void the user's authority to operate the equipment.

WARNING:
TO REDUCE THE RISK OF FIRE OR ELECTRIC SHOCK, DO NOT EXPOSE THIS APPLIANCE TO RAIN OR MOISTURE.

This unit should be used with 12V DC only.

CAUTION:
To prevent electric shocks and fire hazards, do NOT use any other power source.

CAUTION:
To prevent electric shock, do not open the cabinet. No user serviceable parts inside. Refer servicing to qualified service personnel.

Due to design modifications, data given in this instruction book are subject to possible change without prior notice.

This unit is designed for professional use only.

For Sweden

VARNING

Explosionsfara vid felaktigt batteribyte. Använd samma batterityp eller en ekvivalent typ som rekommenderas av apparattillverkaren. Kassera använt batteri enligt fabrikantens instruktion.

For Denmark

ADVARSEL

Lithiumbatteri – Eksplosionsfare ved fejlagtig håndtering. Udskiftning må kun ske med batteri af samme fabrikat og type. Lever det brugte batteri tilbage til leverandøren.

For Norway

ADVARSEL

Lithiumbatteri – Eksplosjonsfare. Ved utskifting benyttes kun batteri som anbefalt av apparatfabrikanten. Brukt batteri returneres apparatieverandøren.

For Finland

VAROITUS

Paristo voi räjähtää, jos se on virheellisesti asennettu. Vaihda paristo ainoastaan laitevalmistajan suosittelemaan tyyppiin. Hävitä käytetty paristo valmistajan ohjeiden mukaisesti.

This equipment is in conformity with the provisions and protection requirements of the corresponding European Directives. This equipment is designed for professional video appliances and can be used in the following environments.

- residential area (in houses) or rural area
- commercial and light industry; e.g. offices or theatres
- urban outdoors

In order to keep the best performance and furthermore for electromagnetic compatibility we recommend to use cables not exceeding the following length:

Port	Cable	Length	Port	Cable	Length
DC IN	Exclusive Cable	2 meters	MONITOR	Monitor Cable	2 meters
LENS	Cable of LENS	0.4 meter	IEEE1394	IEEE1394 Cable	4.5 meters
REMOTE	Single wire	5 meters	MD CONTROL	MD CONTROL Cable	0.6 meters

Caution : Where there are strong electromagnetic waves or magnetism, for example near a radio or TV transmitter, transformer, motor, etc., the picture may be disturbed. In such case, please keep the apparatus away from the sources of the disturbance.

Table of Contents

1. Introduction	
Features	6
Accessories and attachments	7
Cautionary notes for the correct usage of this product	8
Part names and their functions	9
Pin configurations of connectors	12
2. Before shooting	
Connecting through digital output connector	14
Connecting through analog output connector	15
Combining with a presentation system	16
Mounting the lens	17
Connecting power	18
Connecting the IEEE 1394 Cable	18
Mounting the camera	19
Fall prevention	20
3. Settings and adjustments for shooting	
Lens settings	21
Monitor adjustment	21
White balance adjustment	22
Focus adjustment	24
4. Shooting a computer monitor screen	
Shooting a PC monitor	25
Synchronizing flash and External Trigger	26
White spot compensation	28
5. Menu screen settings	
Menu screen flow	30
Setting procedure	32
Menu contents	33
EXPOSURE screen	33
WHITE BALANCE screen	36
PROCESS screen	37
LENS screen	39
SYSTEM SETTING screen	40
MENU (QUICK) screen	41
Resetting menu settings	43

6. Others	
About ALC and EEI operations	44
Specifications	45

Characters and symbols used in this instruction book

CAUTION	Cautionary notes concerning operation of the unit
MEMO	Reference such as restrictions of features, etc.
	Reference page or item

In general, the names of products manufactured by other companies and mentioned in these instructions are trademarks or registered trademarks of these companies.

Symbols like ™, ®, ©, etc., are not used in these instructions.

1. Introduction

Features

- The KY-F1030 is a digital camera employing a 1/2" CCD with 1.45 million effective pixels.
- Employment of RGB primary color filter CCD for color adjustment close to that of 3-CCD cameras.
- Output of 1360 × 1024-pixel digital/analog video signal possible.
- Built-in DSP for real-time processing of the video signal that is output as a 7.5 frames-per-second Y, Cb, Cr 4:2:2 digital signal enables real-time transfer to personal computer by means of IEEE1394 host adapter.
- Using the designated scan rate converter enables display of the analog output on an SXGA-compliant monitor.
- Built-in IEEE1394 connector enables remote control from personal computer. (Software provided.)

Accessories and attachments



Power cable (2 m)
8-pin cable for connecting with AC adapter.
(☞ page E18)

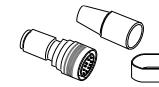

Remote plug (10-pin)
Plug for REMOTE terminal
(☞ page E12)

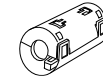

Clamp filter
For IEEE1394 cable
(☞ page E18)



Wire clamp (5 pcs.)
For clamping cables on the rear.



CD-ROM (1 disk)
Contains special application software "KY-LINK".
* For details, see the "Readme.txt" file on the disc "Enu".



Camera mounting bracket locking screw (3 units)
For attaching the mounting bracket on the top surface of the camera.



Instruction manual

1. Introduction (continued)

Cautionary notes for the correct usage of this product

- Before recording an important event, etc., always check to make sure that this product is working properly.
- We are not liable for any missed recordings caused by malfunction of this unit, etc.

■ Phenomena unique to CCD

• Smearing and blooming

When using CCD to shoot a bright light source, a smearing effect may occur running a white line vertical to the light source. In addition, a blooming effect may also occur when the light source is extremely bright, spreading light to the source surroundings.

• Line distortion

Line and patterns may appear distorted when shot.

• White spots

White spots may appear on the screen when operating under high temperatures. Always use the product under recommended ambient temperatures.

White spots may also appear at a slow shutter speed setting (1/8 s or higher).

To reduce this phenomenon, this product is provided with a built-in white spot compensation function. (Z page E28 White spot compensation)

■ Cautionary notes

• Influence of strong electric waves and magnets

Screen noise and discolouration may occur when using the product near antennas of radios and televisions or near transformers, monitors, etc. with strong magnetic force.

• Compatible lenses (⇨ page E17 Mounting the lens)

Although the lens mount of this product is a type C mount, take caution as there are restrictions on the lenses that can be used.

• To save electricity, turn off the system when not in use.

■ Cleaning

When clean the equipment please use dry cleaning cloth or wet cleaning cloth with small amount of alcohol.

Do not spill any liquid into KY-F1030.

■ Do not install the KY-F1030 in a location where it is subject to radiation or x-rays or where corrosive gasses are generated.

Part names and their functions

[Front and bottom]

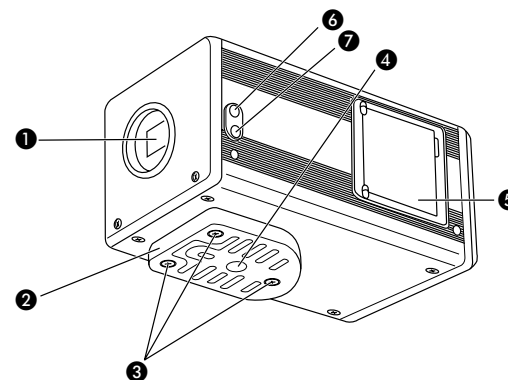

① Lens mount

Although the lens mount conforms to the type C mount lens.

Mounting the lens (⇨ page E17)

② Camera mounting bracket

Although the mounting bracket is mounted on the bottom of the camera when shipped, the bracket can also be mounted on the top of the camera.

Mounting the camera (⇨ page E19)

③ Locking screws for the camera mounting bracket (M2.6 × 6mm, 3 units)

CAUTION

- Always use the attached screws. Using screws that exceed 6mm may result in malfunction of the unit.
- When the bracket is mounted on the top surface of the camera, use the provided screws (length: 10 mm).

④ Screw holes for mounting the camera (1/4-inch)

Used when mounting the camera to a fixer or rotating platform.

⑤ Side switch panel (inside)

Open the door to access a switch panel used when making settings on menus.

Side switch panel section (⇨ page E11)

⑥ [FOCUS] backfocus adjustment screw

This is adjusted to the optimal wide setting when shipped from the factory. Should be readjusted when required by the lens used in combination with the camera.

Focus adjustment (⇨ page E24)

⑦ [LOCK] backfocus locking screw

Screw to lock the backfocus adjustment mechanism.

Focus adjustment (⇨ page E24)

[Rear]

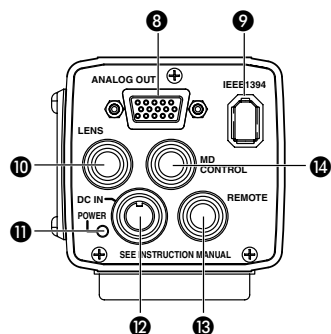

- 8 [ANALOG OUTPUT] connector**
Analog output connector for video signal. Used when connecting the camera to an SXGA-compliant capture board or the designated scan rate converter integrated with the computer.
Pin configurations of connectors ([page E13](#))

MEMO

Only output when the AC adapter (AA-P700) is used as the power supply.

- 9 [IEEE1394] digital output connector**
Digital output connector for video signal. Used when connecting to the PC's IEEE 1394 host adapter.
Pin configurations of connectors ([page E13](#))
- 10 [LENS] connector 1**
To connect the lens' camera cable (for iris control, power supply).
Pin configurations of connectors ([page E12](#))
Mounting the lens ([page E17](#))

- 11 [POWER] indicator**
Lights when power is supplied to the camera.
- 12 [DC IN] connector (Mini DIN 8-pin, female)**
Power (DC 12V) for the camera is supplied through this inlet.
For the power supply, use the AA-P700 AC adapter.
Pin configurations of connectors ([page E12](#))
Connecting power ([page E18](#))
- 13 [REMOTE] terminal (Metal 10-pin, female)**
Used to connect external devices such as a trigger switch or flash unit.
Pin configurations of connectors ([page E12](#))
Connecting through digital output connector ([page E14](#))
Synchronizing flash and trigger ([page E26](#))
- 14 [MD CONTROL] lens connector 2**
To connect the lens control cable (for zoom, focusing control).
Pin configurations of connectors ([page E12](#))
Mounting the lens ([page E17](#))

MEMO

The motorized lens can only be controlled (zoom, IRIS, focus) from the KY-F1030 when the AC adapter (AA-P700) is used as the power supply.

Part names and their functions (continued)

[Side switch panel section (inside)]

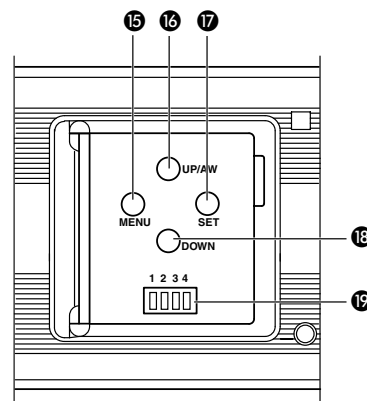

- 15 [MENU] button**
Press this button to output the menu screen through the [ANALOG OUT] connector **6**. Press again to stop display of the menu.
Setting procedure ([page E32](#))
- 16 [UP/AW] auto white balance, UP button**
- [AW (auto white)]**
Press this button to adjust the white balance when the light source illuminating the subject changes.
White balance adjustment ([page E22](#))
 - [UP]**
While the menu screen is displayed, press this button to move up to a selectable item on the menu. While an item is selected, use this button to change the set value.
Setting procedure ([page E32](#))
- 17 [SET] button**
While the menu screen is displayed, press this button to select a submenu or confirm a selected item or set value.
Setting procedure ([page E32](#))
- 18 [DOWN] button**
While the menu screen is displayed, press this button to move down to a selectable item on the menu. While an item is selected, use this button to change the set value.
Setting procedure ([page E32](#))
- 19 Function setting switch**
Used for setting the functions of the KY-F1030.



- Switch 1 <TEST PATTERN>**
ON: Test signal is output.
OFF: The image being shot by the camera is output.
Monitor adjustment ([page E21](#))
SYSTEM SETTING screen ([page E40](#))
- Switch 2 <MENU LOCK>**
ON: Disables the [MENU] button **15**.
OFF: Enables the [MENU] button **15**.
- Switch 3 <SYNC ON GREEN>**
ON: Applies the sync signal to the green (G) channel of the video signal that is output through the ANALOG OUT connector **8**.
OFF: The sync signal is not applied.
- Switch 4 <RESERVED>**
This switch is not used. Leave it at OFF.

1. Introduction (continued)

Pin configurations of connectors

DC IN terminal (Mini DIN 8-pin, female)

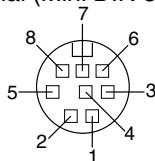

Pin no.	Signal name
1	NC
2	GND
3	NC
4	NC
5	GND
6	12V
7	NC
8	12V

LENS terminal (Metal 12-pin, female)

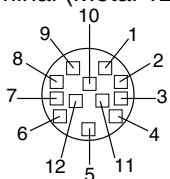

Pin no.	Signal name
1	NC
2	NC
3	GND
4	NC
5	IRIS CONTROL
6	12V DC 400mA max.
7	IRIS POSITION
8	IRIS AUTO /MANU
9 to 12	NC

CAUTION

Use device whose current consumption is max. 400 mA or less.

REMOTE terminal (Metal 10-pin, female)

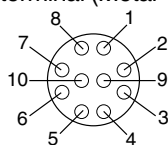

Pin no.	Signal name
1	A. WHITE L active
2	TRG IN L active
3	WEN L active 3.3V(p-p)
4	FLASH
5	NC
6	RS-SDI
7	RS-SDO
8	GND
9	12V
10	OPERATION

CAUTION

- Consult your JVC dealer concerning the remote terminal connection.
- Remote cable must use shielded cable. Outer shield of remote cable must to connect 10-pin connector outer metal shell.
- Do not input the external trigger during the first 5 seconds after the power is turned ON.

Terminal name	I/O	Conditions
2 TRG IN	IN • 3.3V CMOS • Schmidt Trigger • Pull-up to 3.3V at 4.7k Ω	• Contact point recommended • Maximum rated voltage: 5.3V • H level: 2.4 ~ 5.0V • L level: 0 ~ 0.5V • Pulse width: 130 μ s or higher
3 WEN	OUT • 3.3V (p-p) negative polarity	
4 FLASH	OUT • Open collector	• Maximum rated current: 150mA • Maximum rated voltage: 12V

ANALOG OUTPUT terminal (D-sub 15-pin, female)

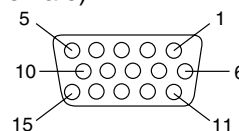

Pin no.	Signal name
1	R OUT 700mV(p-p), 75 Ω
2	G OUT 700mV(p-p), 75 Ω
3	B OUT 700mV(p-p), 75 Ω
4	NC
5	NC
6	R GND
7	G GND
8	B GND
9	WEN
10	GND
11	GND
12	NC
13	Hs (3.3V(p-p) negative polarity)
14	Vs (3.3V(p-p) negative polarity)
15	NC

CAUTION

Do not connect directly to monitor for use with personal computers.

IEEE 1394 connector

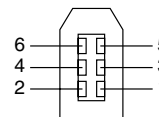

Pin no.	Signal name
1	VP (Current)
2	VG (GND)
3	TPB -
4	TPB +
5	TPA -
6	TPA +

MD CONTROL (Metal 12-pin, female)

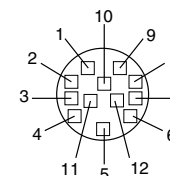

Pin no.	Signal name
1	FOCUS CONT SELECT
2	ZOOM CONT SELECT
3	GND
4 ~ 5	NC
6	+12 V
7	NC
8	FOCUS CTL
9	ZOOM CTL
10 ~ 12	NC

2. Before shooting

Connecting through digital output connector

The KY-F1030 can be remote-controlled from a personal computer, and the shot image can be shown on the computer's monitor.

<Connection Example> Shooting with the camera when the flash is fired by the timing of an external trigger switch.

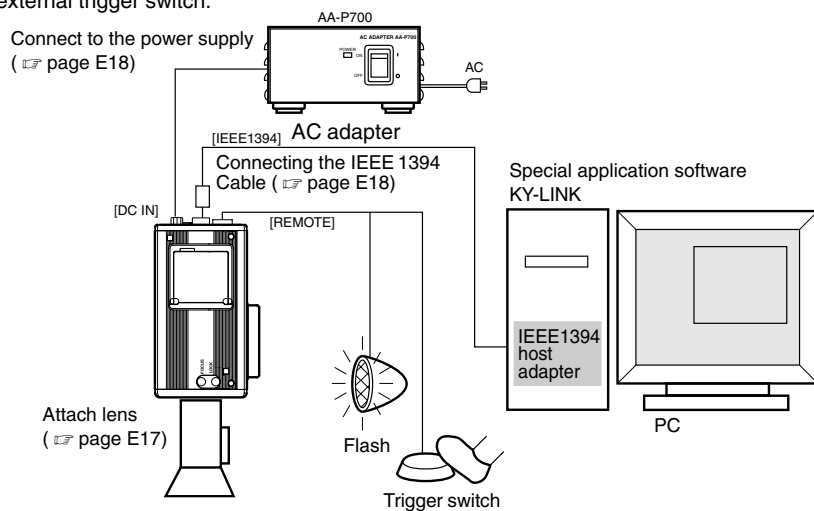

1. Connect the KY-F1030's [IEEE1394] connector to the IEEE1394 host adapter on the PC.
2. Connect the flash and trigger switch to the [REMOTE] terminal.
3. Turn on the power of the KY-F1030.
* The power for KY-F1030 can be supplied from the IEEE1394 connector of personal computer. However, be sure to use the AC adapter (AA-P700) when using the motorized lens or when using both analog output and digital output in combination.
4. Turn ON the PC, and then start up the special application software KY-LINK.
* For how to operate the application software, see the Help file of the KY-LINK.

CAUTION

- Do not turn the power switch on the AC adapter ON/OFF or unplug the IEEE1394 cable while the application software is running.
- Before using the computer with the KY-F1030, release any settings that automatically set the computer in the Stand by or Hibernate mode.

MEMO

If two or more KY-F1030 cameras are connected to one computer, it is not possible to view the camera images simultaneously.

Connecting through analog output connector

The image shot by the KY-F1030 can be shown on the computer's monitor.

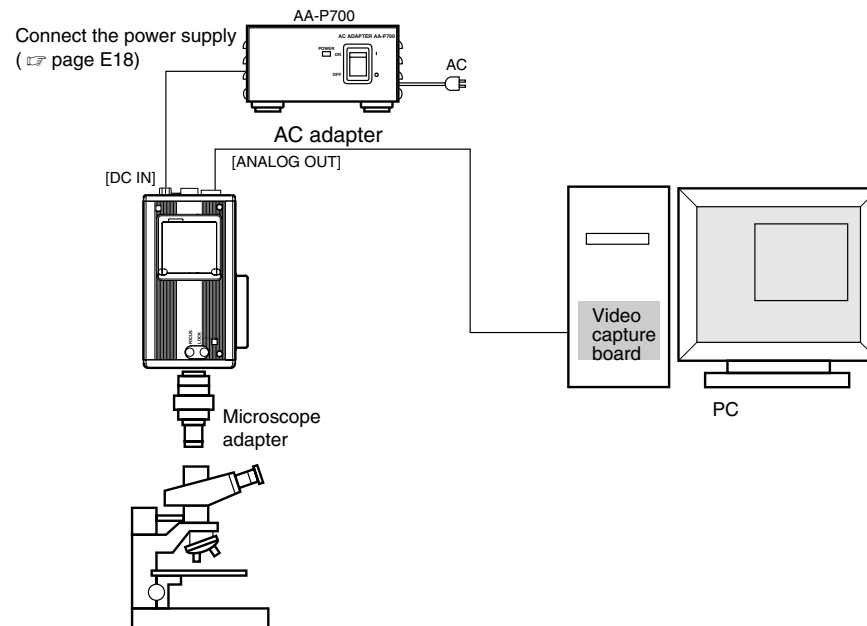

1. Connect the KY-F1030's [ANALOG OUT] connector to the PC's capture board.
2. Connect the AC adapter (AA-P700) to the KY-F1030, and then turn ON the power.
3. Turn ON the PC.
* For instructions on how to operate the video capture board or the employed application software, see the respective instruction manual.

CAUTION

Use a 1/2-inch C-mount microscope adapter compatible with the microscope to be employed.

MEMO

When the shutter speed becomes slower (slower than 1/7.5s), the image may be seen interrupted. Also, the image will not freeze even when the external trigger switch is pressed.

2. Before shooting (continued)

Combining with a presentation system

The image shot by the KY-F1030 can be passed through a scan rate converter and shown on a D-ILA presenter or SXGA-compliant monitor.

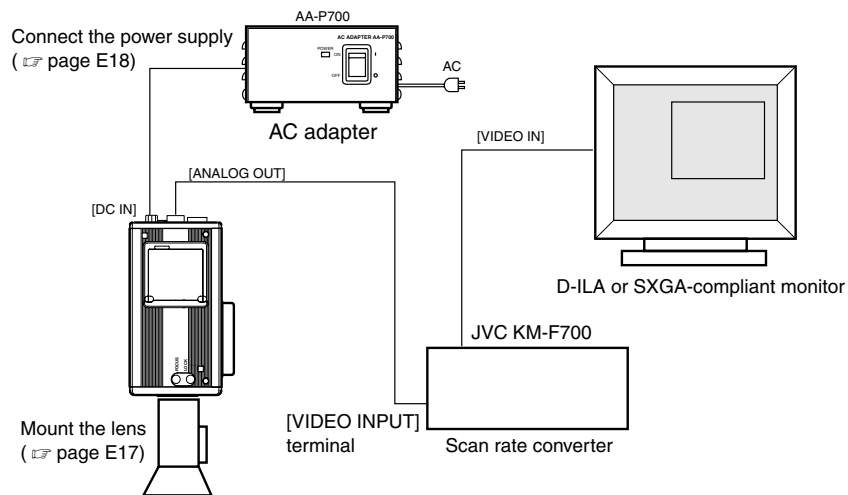

1. Connect the KY-F1030's [ANALOG OUT] connector to the scan rate converter's [VIDEO INPUT] terminal.
2. Connect the AC adapter (AA-P700) to the KY-F1030, and then turn ON the power.
3. Turn ON the other devices.

* Also see the instructions for the scan rate converter to be used.

MEMO

- When connected to the PC through the [IEEE1394] connector, or an RS-232C device is connected to the [REMOTE] terminal, the auto white balance function of the scan rate converter will be disabled.
- When the shutter speed becomes slower (slower than 1/7.5s), the image may be seen interrupted.
- The image will not freeze even when the scan rate converter's [FREEZE] button is pressed.
- The scan rate converter's [SEND] command is invalid.

Mounting the lens

Follow the procedure shown below when mounting a motorized lens. For further details, see the instruction manual of the lens and lens remote control.

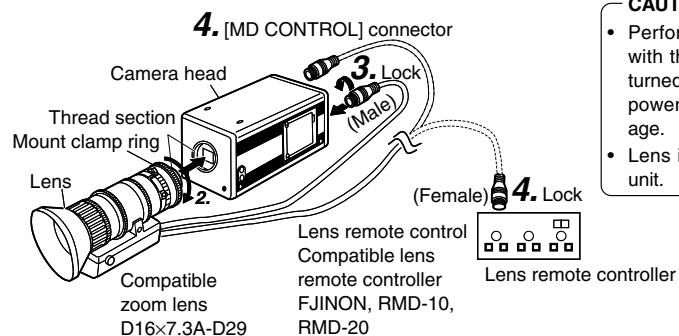

CAUTION

- Perform mounting of the lens with the power of the camera turned OFF. Mounting with the power on could result in damage.
- Lens is not included with this unit.

1. Remove the lens mount cap. At this time, take caution so that dust do not enter inside the mount.
2. To mount the lens, lightly press the thread section of the lens mount onto the thread section of KY-F1030, then turn the lens unit or KY-F1030 slowly clockwise until it is securely tightened.

MEMO

To change the position of the lens rotation:

- ① First, turn the mount clamp ring clockwise (1/4 turns) with the lens facing you.
- ② Slowly turn the lens and after adjusting the position, retighten the mount clamp ring.

3. Insert the camera cable of the lens into the [LENS] connection terminal on the rear of KY-F1030, then securely lock. The iris control is made from the KY-F1030.
4. When using the lens remote controller, connect the lens control cable (female) to the remote control. Also, when focusing and zoom controller is to be performed on the KY-F1030, connect the lens control cable (female) to the [MD CONTROL] terminal on the KY-F1030. When operating the lens iris manually by lens remote control connection, set IRIS MODE to manual. (page E33)

CAUTION

When using a motorized lens, use the AC adapter as power supply for the KY-F1030.

If power is supplied via the [IEEE1394] connector, control of the motorized lens is not possible from the KY-F1030.

2. Before shooting (continued)

Connecting power

Between the 8 pin DC IN terminal on the rear of the main unit and the 8 pin TO CAMERA terminal of the AC adapter (AA-P700) connect the power cable (2m) which is provided.

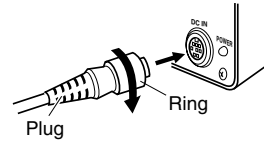
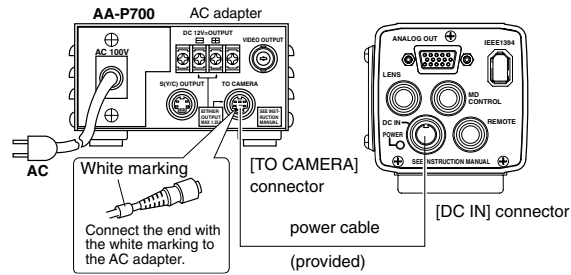

- After inserting the plug completely, tighten the securing ring. Make sure white indication of power cable comes to AA-P700 side.

CAUTION

- Be sure to use the AA-P700 power supply. Before connecting power cable, make sure that the power switch on the AA-P700 is set to OFF. Connecting with the power switch on may result in camera malfunction.
- When connected through the digital output (Connecting through digital output connector (page E14)), power can be supplied from the PC but control of a motorized lens and analog output will not be possible.

MEMO

Wait at least 10 seconds before turning the power switch back on, when it has just been turned off. Turning the power switch on and off quickly may cause malfunctions, such as failure to boot, etc.

Connecting the IEEE1394 Cable

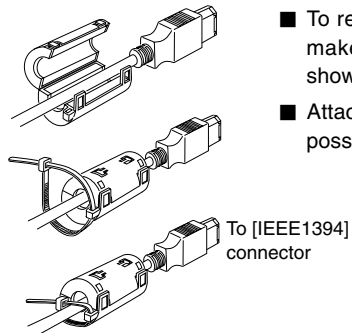

- To reduce the emission of unwanted radio waves, make sure to attach the provided clamp filter as shown in the figure on the left.
- Attach the clamp filter as close to the KY-F1030 as possible as shown in the figure.

Mounting the camera

< Mounting method >

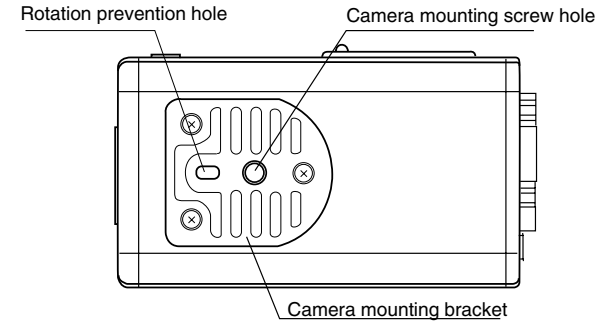

- When mounting the camera, use the camera mount screw hole located on the camera mounting bracket.
- When mounting the camera, use the rotation prevention hole to prevent the unit from falling and securely mount the unit.

< Changing the camera mounting bracket position >

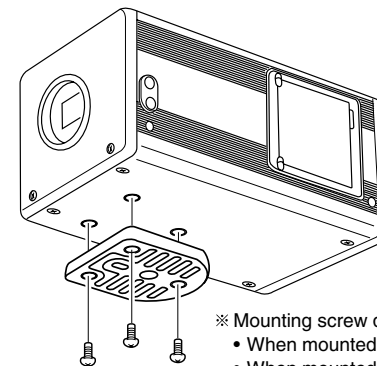

When shipped, the camera mounting bracket is mounted on the bottom of the unit. To mount it on the top of the unit, simply remove the 3 locking screws holding the camera mounting bracket.

CAUTION

- When the camera mounting bracket is mounted on the top surface of the camera, be sure to use the provided screws (length: 10 mm).

※ Mounting screw dimensions:

- When mounted on top: 10 mm
- When mounted on underside: 6 mm

2. Before shooting (continued)

Fall prevention

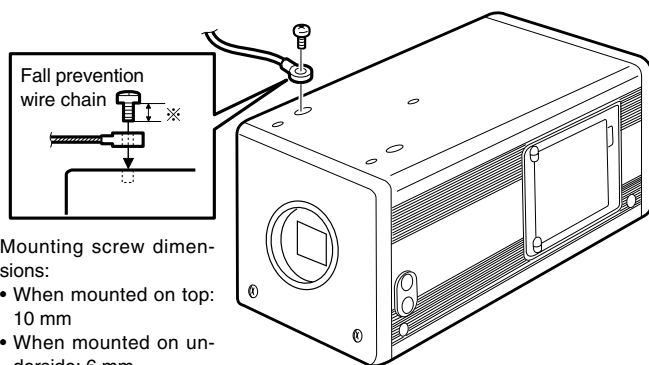

- ※ Mounting screw dimensions:
- When mounted on top: 10 mm
 - When mounted on underside: 6 mm

MEMO

- Special attention is required when mounting the unit to the wall or ceiling. Rather than attempting to do it yourself, request a qualified person to perform such installation. Falling of the unit may result in bodily injury.
- To prevent the unit from falling, connect the unit to a strong surface with a wire chain, etc. When connecting such chain, use the bracket locking screw hole on the side which the camera mounting bracket is not mounted.
 - When mounted on top: M 2.6 × 10 mm (provided)
 - When mounted on underside: M 2.6 × 6 mmTake special caution to the length of the optional wire as well.
- For the fall-preventive wire, use the one with the strength that is more than 10 times of a mass including the lens.

3. Settings and adjustments for shooting

Lens settings

Set according to whether the used lens to be used is an auto-iris lens or a manual lens.

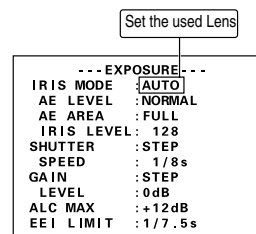

(Default setting: AUTO)

Set the [IRIS MODE] on the [EXPOSURE] screen.
(page E33)

AUTO : Setting when auto-iris lens is used in auto mode.
MANUAL : Set when using a manual lens, using an auto-iris lens in **MANUAL** or no lens.

* If the auto-iris lens cable is not connected to the [LENS] connector, the setting automatically becomes "MANUAL".

Monitor adjustment

The colour contrast and brightness are adjusted whilst, built-in test signals of the camera are being displayed on the PC monitor.

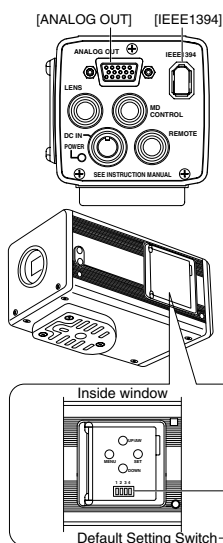

1. Connect the [ANALOG OUT] connector or the [IEEE1394] connector to the PC.

2. Set the function setting switch NO.1 on the switch panel on the side of the KY-F1030 to "ON".



3. Turn ON the KY-F1030, and then start the PC.

* When connecting through the [IEEE1394] connector, power is supplied from the PC.

4. Adjust the monitor.

MEMO

- For how to adjust, see the instructions for the employed monitor.
- The peak level of the test signal is set to 0.7V from the factory. To use 0.57V, change the setting by [TEST PATTERN] → [LEVEL] on the [SYSTEM SETTING] screen.
page E40 TEST PATTERN

3. Settings and adjustments for shooting (cont'd)

White balance adjustment

Since the colour of light (light temperature) changes depending on the light source, readjust the white balance (AUTO WHITE) when the light source of the object changes.

※ In the digital output mode, white balance adjustment should be performed using the special application software [KY-LINK].

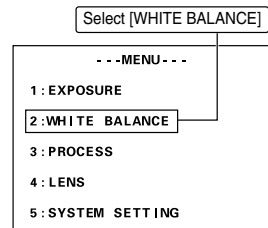
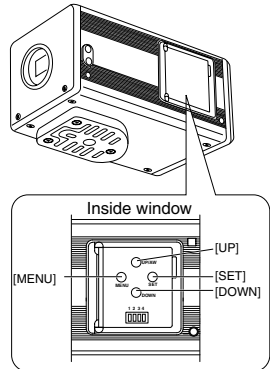

[MENU] screen

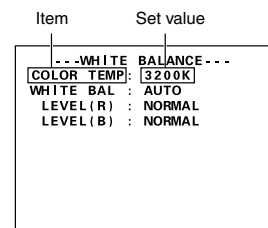

WHITE BALANCE screen

1. Open the side switch panel, and press the [MENU] button for 2 seconds or longer. The [MENU] screen appears on the monitor screen.
2. Press the [UP] or [DOWN] button to select [2. WHITE BALANCE] (the text will be displayed in purple when selected), then press the [SET] button. The [WHITE BALANCE] screen will appear.
3. Press the [UP] or [DOWN] button to select [COLOR TEMP] (the text will be displayed in purple when selected), then press the [SET] button. The set value will be displayed in purple, indicating that it can be changed.
4. Press the [UP] or [DOWN] button to select the setting depending on the usage environment.
3200K: when using low temperature lighting such as a halogen lamp, etc.
5600K: when using high temperature lighting under the sunlight, etc.
Pressing the [SET] button will register the setting in the main unit memory. The set value will be displayed in white.

MEMO

Pressing the [MENU] button without pressing the [SET] button will not register the set value and the unit will return to the setting prior to the change.

5. Press the [UP], [DOWN] and [SET] buttons to set [WHITE BAL] in the [WHITE BALANCE] screen to "AUTO".
6. After pressing the [MENU] button twice to return to the normal screen, place a white object with the same lighting conditions as the object to record, then zoom in to display white near the center of the screen (more than 80% area of screen).

3. Settings and adjustments for shooting (cont'd)

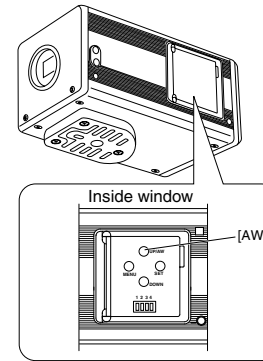

7. Press the [AW] (Auto White) button.

- When auto white is in operation, the auto-white operation area and [AUTO WHITE OPERATION] will be displayed on the monitor screen.
- When the white balance is successfully set, [AUTO WHITE OK] will appear for about 3 seconds on the screen and the unit will return to the normal screen.

MEMO

- When the shutter speed is set to a slow speed, it may take a while before the white balance operation is completed.
- With the factory setting, it may take up to 13 seconds depending on the subject. (When setting the shutter speed to 1 s takes maximum of 1 minute 45 seconds.)

Auto-white operation area

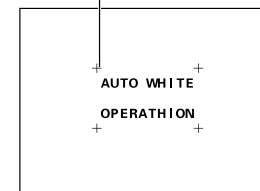

Auto white in operation

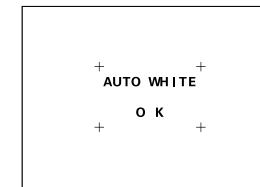

Auto white operation completed

MEMO

- When the colour temperature of the subject changes as the darkness increases, do not change the illumination. Instead, narrow the lens iris, and take the white balance again by pressing the [AW] (Auto White) button.
- When a shutter speed exceeding 1 sec is used, it is not possible to launch the auto white balance function.
Temporarily return the shutter setting to below 1 sec and launch the auto white balance function, or set the [WHITE BAL] item to "MANUAL" or "PRESET".
- Pressing the [AW] button in the FREEZE condition, cancels the freeze.

- Error display
When the auto white balance cannot be set, one of the following error messages will appear and the unit will return to the normal screen.

NG: OBJECT (bad object)

Displayed when the object consists of little whiteness or when the colour temperature is not correct. Change to a white object and redo the white balance.

ERROR: LOW LIGHT (shortage of light)

Displayed when the lighting is too dark. Brighten the lighting and redo the white balance.

ERROR: OVER LIGHT (excessive light)

- Displayed when the lighting is too bright. Close the lens iris or lower the brightness and redo the white balance.

3. Settings and adjustments for shooting (cont'd)

Focus adjustment

Back focus adjustment can be performed on the KY-F1030. When using a lens that is not provided with function for adjustment of back focus, make the adjustment as described in the following. Perform this adjustment while observing the PC's monitor screen.

* When using a lens that is provided with function for adjustment of back focus, make the adjustment on the lens side.

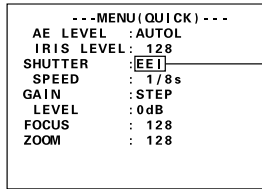
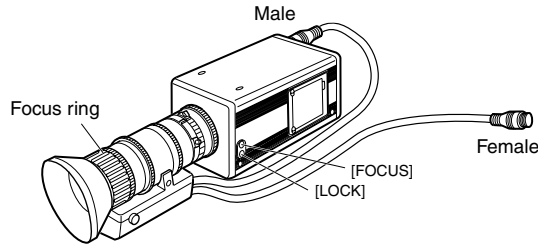

Set the EEI mode

1. Using a screwdriver, loosen the [LOCK] backfocus locking screw by turning it counterclockwise.
2. Open the lens' iris.
3. If the image is blurred with white, make the setting in the EEI mode. [MENU (QUICK)] screen (☞ page E41)
4. Zoom lens to maximum telephoto position.
5. Adjust the focus of the lens.
6. Zoom lens to maximum wide-angle position.
7. Turn the [FOCUS] backfocus adjustment screw to obtain optimal focus.
8. Repeat steps 4 through 7 two or three times.
9. Turn the [LOCK] backfocus locking screw clockwise to lock.

4. Shooting a computer monitor screen

Shooting a PC monitor

Horizontal line noise will appear on the screen when attempting to record images on a PC monitor or display. To clear this noise, KY-F1030 shutter speed must be adjusted with scan speed of the monitor.

※ In the digital output mode, the settings should be performed using the special application software [KY-LINK].

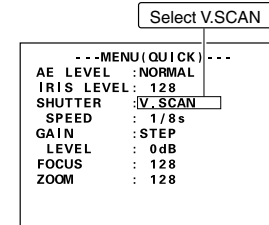
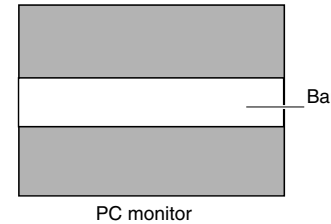
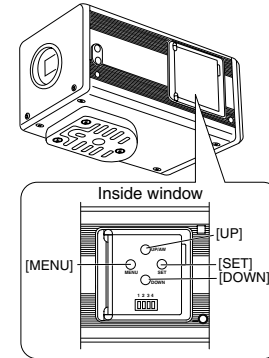

MENU (QUICK) screen

1. Open the side switch panel, and press the [MENU] button. The [MENU (QUICK)] screen appears on the monitor screen.
2. Press the [UP] or [DOWN] button to select [SHUTTER], then press [SET] (The set value of [SHUTTER] item will be displayed in purple).
3. Use the [UP] or [DOWN] button to change the set value to "V. SCAN", then press the [SET] button (The set value of [SHUTTER] item will return to white).
4. Next, press the [UP] or [DOWN] button to select [SHUTTER SPEED], then press the [SET] button.
5. Press either [UP] or [DOWN] to change the shutter speed.
When a black bar can be seen on the screen:
decrease the shutter speed by pressing the [DOWN] button.
When a white bar can be seen on the screen:
increase the shutter speed by pressing the [UP] button.
6. Press the [SET] button when the bar is at its minimum. Data is registered to KY-1030 memory.
7. Press the [MENU] button to return to the normal screen.

MEMO

- The vertical scan frequency differs depending on the PC type and the horizontal bar may not be completely cleared away. The frequency may also change depending on the software used.

4. Shooting a computer monitor screen (cont'd)

Synchronizing flash and external trigger

To synchronize the flash with the input of an external trigger, use the [REMOTE] connector on the rear.

Pin configurations of connectors ([page E12](#)).

■ When the shutter mode is other than “RANDOM” “EEI” ([page E34, SHUTTER item](#))

- In response to the trigger input, the KY-F1030 outputs a flash signal for the CCD accumulation period of the next frame.
- The image shot at the moment that the FLASH signal is outputted is output as the next frame.
- In the case of digital output, output stops with shooting of this frame and the image on the PC's monitor will be in the FREEZE condition.
- How to cancel the FREEZE condition can be selected. ([page E40, \[FRZ CANCEL\] item](#))
- The trigger interval must be minimum 3 frames (405 msec) at a shutter speed of 1/7.5 s or faster.
- When the FREEZE cancel mode is set to “MANUAL”, FLASH will not be output in response to the trigger input for FREEZE cancellation.

Timing chart

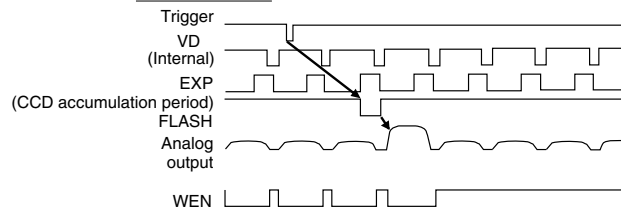

MEMO

- During output of the FLASH signal, the [FREEZE] indication will appear momentarily on the computer monitor. If it is preferred that the indication is not shown, set the [FRZ DISPLAY] item to “OFF”.
[Page E40, \[FRZ DISPLAY\] item.](#)

■ When the shutter mode is “RANDOM”

- CCD accumulation is performed in sync with the trigger input, and this period is output as the FLASH signal.
- At the same shutter speeds the delay from the trigger input to the FLASH output is almost uniform as shown in Table A below. Also, the pulse width of the FLASH output differs with the shutter speed.
- The trigger input interval is restricted as shown in Table B. Do not input at a shorter interval than the minimum interval shown in the table.

Shutter speed	A Delay [ms]	B Minimum trigger interval [ms]
1/8s	0.203 ± 0.063	395
1/15s	0.203 ± 0.063	337
1/30s	0.203 ± 0.063	304
1/60s	0.203 ± 0.063	287
1/125s	0.203 ± 0.063	278
1/250s	2.953 ± 0.063	277
1/500s	4.953 ± 0.063	277
1/1000s	5.953 ± 0.063	277
1/2000s	6.453 ± 0.063	277

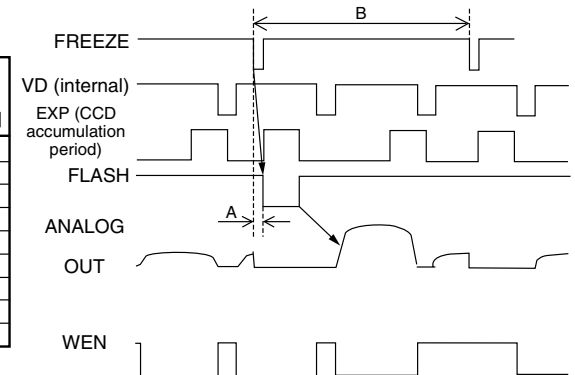

- * In the following situations, the FLASH signal is continuously generated in sync with the CCD regardless of the external trigger.

- When [SHUTTER] on the EXPOSURE screen is set to “EEI”.
- When [GAIN] on the EXPOSURE screen is set to “ALC”.
- When [IRIS MODE] on the EXPOSURE screen is set to “AUTO”.
- While AW (Auto White) is operating.

MEMO

- In the condition where the shutter mode is RANDOM, the image quality may deteriorate at the time of FREEZE as noise may be applied or white spots may appear.

4. Shooting a computer monitor screen (cont'd)

White spot compensation

One of the inherent, general characteristics of CCDs is that white spots may appear in the image at slow shutter speeds or during shooting at high temperatures.

To moderate this phenomenon, this camera is provided with a white spot compensation function.

※ In the digital output mode, white spot adjustment should be performed using the special application software [KY-LINK].

How to use

■ White spot detection

Because the number of spots and their size differ with the temperature and shutter speed, etc., it is necessary to detect the positions of the white spots under the conditions of use before the white spot compensation is used.

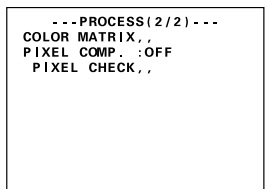
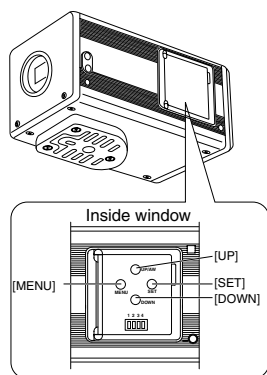

PROCESS (2/2) screen

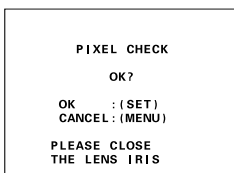

PIXEL CHECK screen

1. Make the settings under the conditions at which the unit is to be used (ambient temperature and shutter speed, etc.).
2. Prevent light from entering the CCD by closing the lens iris, etc.
3. Open the side switch panel, and press the [MENU] button for 2 seconds or longer. The [MENU] screen appears on the monitor screen.
4. Press the [UP] or [DOWN] button to select [PIXEL CHECK] on the [PROCESS(2/2)] screen, and then press the [SET] button to display the [PIXEL CHECK] screen.
5. When the [SET] button is pressed, detection of the positions of white spots starts. The detection may take several minutes.
6. When the detection is completed, "PIXEL CHECK OK" is displayed for about 3 seconds before the [MENU] screen returns.

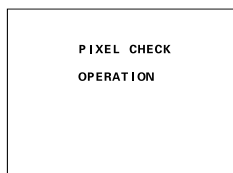

Screen during detection

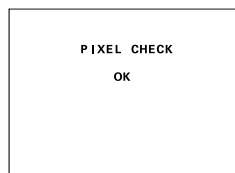

Screen when detection is completed

MEMO

- The camera's white spot compensation function cannot compensate completely for all white spots. White spot detection and compensation by this camera must be performed under the following conditions. White spot compensation is not possible under other conditions. Even when these conditions are met, the properties of the white spots may prevent compensation.

No. of detections and compensations: Within a total of 10 spots.

- The screen shown on the right may appear if light enters the CCD while white spot detection is being performed, or due to the conditions of the white spots. In this case, confirm that light is not entering the CCD. If light is not entering the CCD but the screen nevertheless remain displayed, accelerate the shutter one step and perform the detection again.
- When white spot compensation is carried out, the compensation of the pixel data is performed based on surrounding pixel data, which means that accurate data may not be obtained in case of an image with fine details.
- The result of the white spot detection is retained until the next white spot detection is performed.

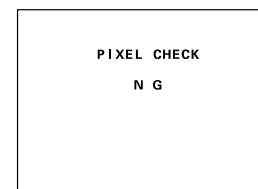

5. Menu screen settings

Menu screen flow

There are 2 types of menu screens: MENU (QUICK) screen, MENU screen.

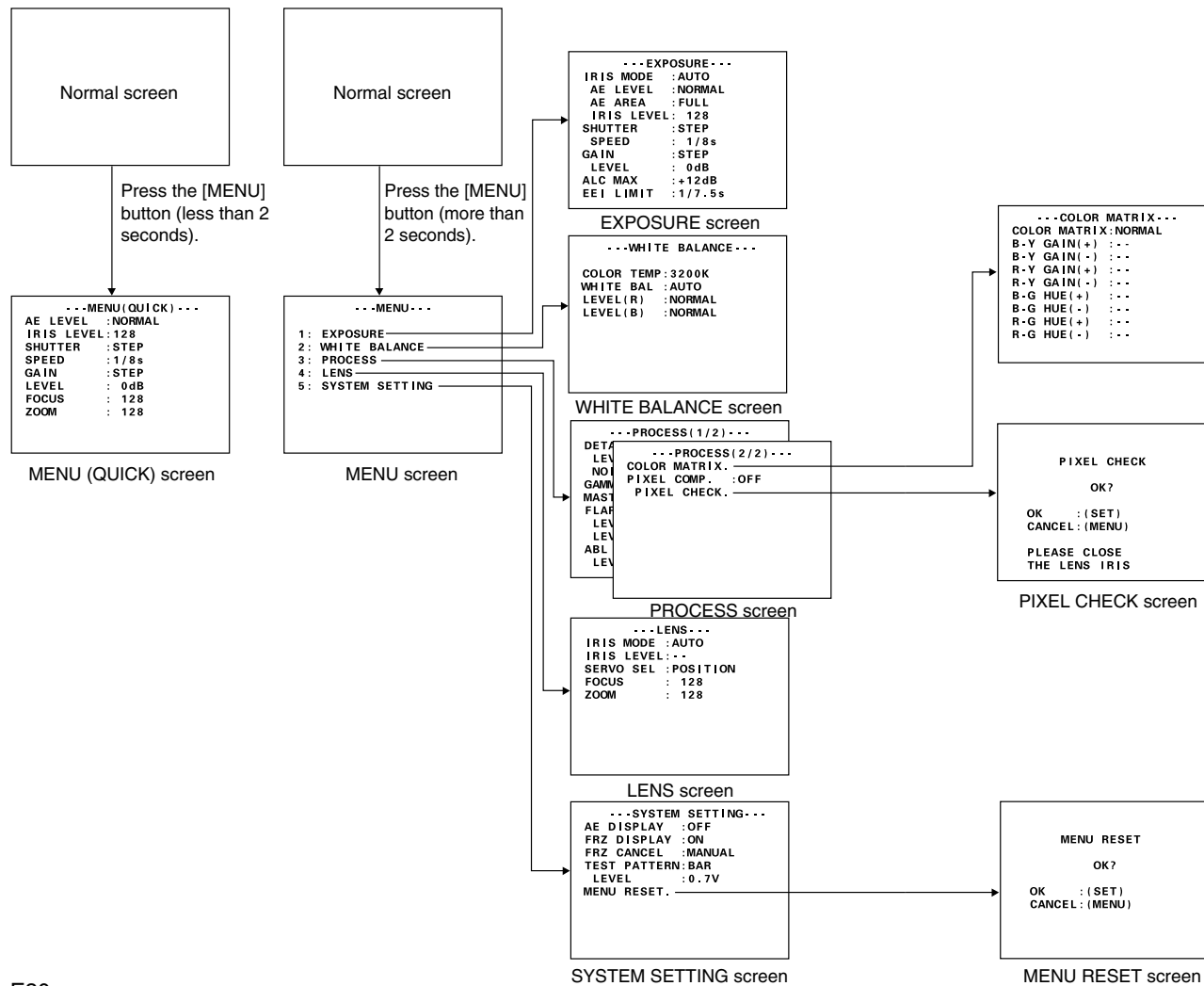

MEMO

- Pressing the [MENU] button while in any of the menu screens will return the unit to the previous screen.
- When an RS-232C device is connected, the items that can be operated by the remote control unit will be indicated by [REMOTE] in the [MENU] screen, and these items will not be operable directly on the camera.
- The menu is not displayed if the KY-F1030 is connected to the PC through the digital output connector (page E14).

5. Menu screen settings (continued)

Setting procedure

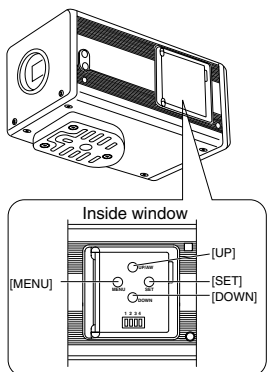

1. Open the side switch panel, and press the [MENU] button for 2 seconds or longer. The [MENU] screen appears on the monitor screen.

* The [MENU (QUICK)] screen can be displayed by pressing the [MENU] button for less than 2 seconds.

2. Press the [UP] or [DOWN] button to select a menu item (the menu item will be displayed in purple when selected), then press the [SET] button to display the submenu screen.

3. In the submenu screen, press the [UP] or [DOWN] button in the same manner as above to select a submenu item, then press the [SET] button. The setting will be confirmed and registered to the memory.

The set value will be displayed in purple, indicating that it can be changed.

4. Use the [UP] and [DOWN] buttons to change to set value, then press the [SET] button to confirm (the set value will return to white).

MEMO

- Continuous pressing of the [UP] or [DOWN] button will change the set value in increment of 10. Use this feature when making large changes in value.
- Pressing the [MENU] button without pressing the [SET] button will return the setting to the previous value without making changes.

5. Press the [MENU] button twice to return to the normal screen.

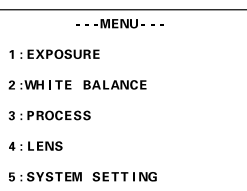

MENU screen

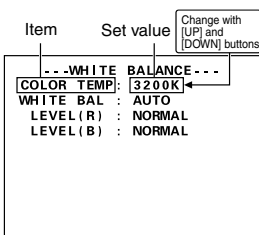

WHITE BALANCE screen (example)

Menu contents

- 1 : EXPOSURE: Used for settings related to the video level, such as iris, shutter, sensitivity, etc.
- 2 : WHITE BALANCE: Used to make settings for color temperature and white balance.
- 3 : PROCESS: Used to make settings for detail compensation, gamma, master black, flare compensation, Auto Black Level (ABL), etc.
- 4 : LENS : Sets the control method for the lens iris and lens focus, and zoom control method.
- 5 : SYSTEM SETTING: Sets the screen display method and level of test pattern.

EXPOSURE screen

[] indicates the factory setting

Item	Set Value	Contents
IRIS MODE	[AUTO] MANUAL	Switched in accordance with the used lens. AUTO: When using auto-iris lens. MANUAL: • When using manual iris lens. • Lens not mounted • When using manual iris while auto-iris lens is mounted. *When the auto-iris lens cable is not connected to the [LENS] connector, the setting automatically becomes "MANUAL".
AE LEVEL	-128 -127 : [NORMAL] : 126 127	Used to adjust the video level when auto-iris, ALC and EEI are used, Increasing the value: Raises the level Decreasing the value: Lowers the level MEMO "----" is displayed when auto-iris, ALC, and EEI are all set to not operate.
AE AREA	[FULL] SQUARE SPOT	Used to set the detection area for auto-iris. Switch the setting in accordance with the conditions of use. <div style="display: flex; justify-content: space-around; align-items: center;"> <div style="text-align: center;"> <p>FULL</p> <p>Detection area</p> </div> <div style="text-align: center;"> <p>SQUARE</p> <p>Detection area</p> </div> <div style="text-align: center;"> <p>SPOT</p> <p>Detection area</p> </div> </div> MEMO During selection of the detection area, the detection area is shown on the screen connected to the analog output.
IRIS LEVEL	0 1 • [128] • 254 255	Used to set the iris level when the IRIS MODE is set to "MANUAL". Increasing the value: Opens the iris Decreasing the value: Closes the iris

5. Menu screen settings (continued)

EXPOSURE screen (continued)

[] indicates the factory setting

Item	Set Value	Contents
SHUTTER	[STEP] V.SCAN RANDOM EEI OFF	Used to switch the shutter mode. STEP: The shutter speed can be changed with the [SPEED] item. V. SCAN: The shutter speed can be changed with the [SPEED] item. Enables more detailed setting than [STEP]. RANDOM: Used to synchronize the CCD accumulation timing with the Trigger input. The shutter speed can be changed with the [SPEED] item. EEI: Used to automatically change the shutter speed in accordance with the brightness of the subject. OFF: Fixed at 1/7.5 s.
SPEED When "STEP" is selected	4s 2s 1s 1/2s 1/4s [1/8s] 1/15s 1/30s 1/60s 1/125s 1/250s 1/500s 1/1000s 1/2000s	The shutter speed can be changed when SHUTTER is set to "STEP", "V.SCAN" or "RANDOM".
SPEED When "V.SCAN" is selected	3.990s • [1/7.501s] • • 1/5906.836s	<p>MEMO</p> <ul style="list-style-type: none"> When the shutter speed is slower than 1/7.5 s, the following phenomena may occur. <ol style="list-style-type: none"> The screen update rate becomes longer in the case of digital output. The displayed image will appear intermittently in the case of analog output. Time will be required for the auto white, auto iris and ALC operations. If the shutter speed is set slower than 1 s, these operations will behave as follows. <p>Auto white : Auto white balance function cannot be started. (☞ page E23 White balance adjustment)</p> <p>Auto iris : Stops at the iris value at that time. ALC : Stops at the sensitivity at that time.</p> <p>To use a shutter speed slower than 1 s, use with the following settings selected: IRIS MODE : MANUAL GAIN : STEP or V.GAIN</p> <ul style="list-style-type: none"> There may be shortage of light when the shutter speed is increased. In this case, adjust the iris or sensitivity. Attention should be paid to the picture quality when the sensitivity is raised since the image becomes coarse.
SPEED When "RANDOM" is selected	1/7.500s • [1/126.134s] • • 1/5648.193s	

EXPOSURE screen (continued)

[] indicates the factory setting

Item	Set Value	Contents
GAIN	[STEP] ALC V.GAIN	Used to switch the sensitivity mode. STEP: The sensitivity can be changed with the "LEVEL" item. ALC: The sensitivity is automatically changed in accordance with ambient brightness. V.GAIN: The sensitivity can be changed in detail with the "LEVEL" item.
LEVEL When "STEP" is selected	[0dB] +6dB +12dB	
LEVEL When "V. GAIN" is selected	[0dB] +0.2dB +0.4dB • • +12dB	
ALC MAX	[+12dB] +6dB	Sets the maximum sensitivity of ALC, which automatically switches the sensitivity in accordance with ambient brightness.
EEI LIMIT	[1/7.5s] 1s	Sets the minimum value for the shutter speed when the shutter mode is set to "EEI". 1/7.5s: Set to 1/7.5s. 1s: Set to 1s. * When analog output is used, the monitor image will be stopping many times when the shutter speed becomes slower, so set at "1/75.s".

5. Menu screen settings (continued)

WHITE BALANCE screen

[] indicates the factory setting

Item	Set Value	Contents
COLOR TEMP	[3200K] 5600K	Used to set the standard color temperature of the white balance. 3200K: For use under low color temperature illumination, such as halogen lamps, etc. 5600K: For use under high color temperature illumination, such as sunlight, etc.
WHITE BALANCE	[AUTO] MANUAL PRESET	Used to set the white balance mode. AUTO: Select this setting when white balance adjustment should be operating. (☞ page E23 White balance adjustment) Fine adjustment of the white accomplished by the white balance can be made using LEVEL (R) and LEVEL (B). MANUAL: The white balance can be changed using LEVEL (R) and LEVEL (B). PRESET: The white balance is fixed at the setting made for the COLOR TEMP item.
LEVEL (R) When "AUTO" is selected.	- 8 - 7 • [NORMAL] • 8	The red color in the white balance can be adjusted when [WHITE BAL] is set to "AUTO" or "MANUAL". Increasing the value: Red tint of screen becomes stronger Decreasing the value: Red tint of screen becomes weaker
LEVEL (R) When "MANUAL" is selected.	0 • • [32] • 63	
LEVEL (B) When "AUTO" is selected.	- 8 - 7 • [NORMAL] • 8	The blue color in the white balance can be adjusted when [WHITE BAL] is set to "AUTO" or "MANUAL". Increasing the value: Blue tint of screen becomes stronger Decreasing the value: Blue tint of screen becomes weaker
LEVEL (B) When "MANUAL" is selected.	0 • • [32] • 63	

Color temperature when COLOR TEMP and WHITE BALANCE are set. * Regard the values as reference values.

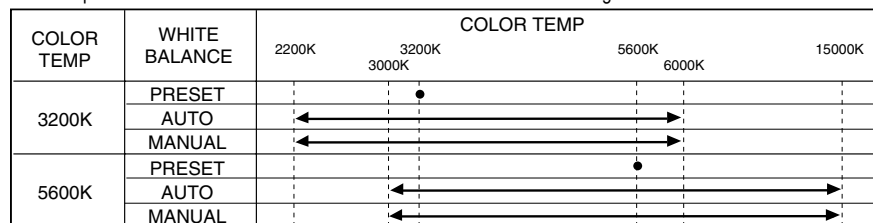

PROCESS screen

[] indicates the factory setting

Item	Set Value	Contents
DETAIL	[ON] OFF	Used to set whether to emphasize details (contours). ON: Detail emphasis is performed. OFF: Detail emphasis is not performed.
LEVEL When "ON" is selected	-7 -6 • [NORMAL] • 7	When [DETAIL] is set to "ON", the emphasis level of the detail is adjusted. Increasing the value: Sharpens details Decreasing the value: Softens details
NOISE SUP. When "ON" is selected	[OFF] LOW MIDDLE HIGH	Reduces noise in the video signal. OFF: Noise reduction is not performed. LOW, MIDDLE, HIGH: Noise reduction is performed. The reduction rate increases in the order of LOW → MIDDLE → HIGH. MEMO Note that when the noise reduction is increased, details may get lost in the coarse parts of the image.
GAMMA	[ON] OFF	ON: The video signal is compensated to make the image viewed on the screen natural. OFF: No compensation and the video signal is output linearly.
MASTER BLACK	-32 -31 • [0] • 31	Used to adjust the pedestal level (master black), which is the standard of black when the lens is capped. To see more details in black areas, raising the pedestal level will brighten the entire screen. Increasing the value: Raises the pedestal level Decreasing the value: Lowers the pedestal level
FLARE	[ON] OFF	Compensation of the black level when flaring effect occurs and black areas are tinted with color due to irregular reflection of light entering the lens.
LEVEL (R) When "ON" is selected	-32 -31 • [NORMAL] • 31	Compensation of the black level of Rch Increasing the value: Red tint becomes weaker Decreasing the value: Red tint becomes stronger
LEVEL (B) When "ON" is selected	-32 -31 • [NORMAL] • 31	Compensation of the black level of Bch Increasing the value: Blue tint becomes weaker Decreasing the value: Blue tint becomes stronger

5. Menu screen settings (continued)

PROCESS screen (continued)

[] indicates the factory setting

Item	Set Value	Contents
ABL	[ON] OFF	Used to set whether to use automatic adjustment of the black level in accordance with the signal level during shooting. Use this adjustment when the black level of the video image fluctuates.
LEVEL When "ON" is selected	-32 -31 • [NORMAL] • 31	Black level is adjusted. Increasing the value: Lowers the black level. (Compensation becomes higher) Decreasing the value: Raises the black level. (Compensation becomes smaller)
COLOR MATRIX.	[NORMAL] ADJUST	Used to set whether the color matrix value should be a standard value or variable. NORMAL: Standard value used for color matrix. ADJUST: The color matrix becomes variable. The following adjustments can only be made when this setting is selected.
B - Y GAIN (+) When "ADJUST" is selected	-8 -7 • [NORMAL]	Adjusts the color saturation. Increasing the value: Colors become more glowing Decreasing the value: Colors become duller ◦ B - Y GAIN (+): More blue ◦ B - Y GAIN (-): More yellow ◦ B - Y GAIN (+): More red/magenta ◦ B - Y GAIN (-): More green/cyan
B - Y GAIN (-) When "ADJUST" is selected	7 8	
R - Y GAIN (+) When "ADJUST" is selected		
R - Y GAIN (-) When "ADJUST" is selected		
B - G HUE (+) When "ADJUST" is selected	-32 -31 • [NORMAL]	
B - G HUE (-) When "ADJUST" is selected	• 30 31	
R - G HUE (+) When "ADJUST" is selected		
R - G HUE (-) When "ADJUST" is selected		

E38

PROCESS screen

[] indicates the factory setting

Item	Set Value	Contents
PIXEL COMP.	[OFF] ON	Selects whether or not white spot compensation should be performed. OFF : White spot compensation not performed. ON : White spot compensation performed. ☞ page E28 [White spot compensation]
PIXEL CHECK		Detects the positions of white spots. ☞ page E28 [White spot compensation]

LENS screen

[] indicates the factory setting

Item	Set Value	Contents
IRIS	[AUTO] MANUAL	Switched in accordance with the employed lens. AUTO: When auto-iris lens is employed. MANUAL: • When manual iris lens is employed. • No lens mounted. • When auto-iris lens is mounted but used as manual iris lens. * If the auto-iris lens cable is not connected to the [LENS] connector, the setting automatically becomes "MANUAL".
IRIS LEVEL When "MANUAL" is selected	0 1 • [128] • 255	Sets the iris level when "MANUAL" is selected for the IRIS MODE. Increasing the value: Opens the iris Decreasing the value: Closes the iris
SERVO SEL	[POSITION] SPEED	Sets the lens control method. Normally, use the "POSITION" setting. * If the lens control cable is not connected to the [MD CONTROL] connector, "- - -" is displayed.
FOCUS When "POSITION" is selected	0 1 • [128] • 255	Selects the focus position. Increasing the value: Focus far away Decreasing the value: Focus nearby
ZOOM When "POSITION" is selected	0 1 • [128] • 255	Selects the zoom position. Increasing the value: Toward telephoto Decreasing the value: Toward wide-angle

E39

5. Menu screen settings (continued)

SYSTEM SETTING screen

[] indicates the factory setting

Item	Set Value	Contents
AE DISPLAY	[OFF] ON	Used to set whether the ALC, EEI and IRIS values are displayed on the analog output screen. OFF: No on-screen-display ON: On-screen-display
FRZ DISPLAY	[ON] OFF	Used to set whether the "FREEZE" indicator is shown on the screen at the time of trigger input. ON: Displayed OFF: Not displayed
FRZ CANCEL	[MANUAL] AUTO (1s) AUTO (3s) AUTO (5s) OFF	Sets the method for canceling the FREEZE when the monitor screen is in FREEZE condition when connection is made through digital output. MANUAL : Cancelled by trigger input. AUTO(1s) : Cancelled after 1 second. AUTO(3s) : Cancelled after 3 seconds. AUTO(5s) : Cancelled after 5 seconds. OFF : Not cancelled. * When set to "AUTO" or "OFF", the displayed screen can be updated by trigger input during the FREEZE condition.
TEST PATTERN	[BAR] RAMP IMPULSE	Sets the test pattern type output when the function setting switch No.1 <TEST PATTERN> is set to "ON". BAR : "BAR" pattern is output. RAMP : "RAMP" pattern is output. IMPULSE : "IMPULSE" pattern is output.
LEVEL When "BAR"/ "IMPULSE" is selected	[0.7V] 0.57V	Sets the level of the color signal bar output from the KY-1030's [ANALOG OUT] connector. 0.7V: 0.7V test signal is output 0.57V: 0.57V test signal is output
MENU RESET		Resets all the set values of menus to the initial values. ☞ page E43, Resetting menu settings

MENU (QUICK) screen

[] indicates the factory setting

Item	Set Value	Contents
AE LEVEL	-128 -127 • [0] • • 126 127	Used to adjust the video level when using auto iris, ALC and EEI. Increase the number : raise the level Decrease the number : lower the level MEMO "---" is displayed when auto iris, ALC, and EEI are all set to not work.
IRIS LEVEL	0 1 • • [255]	Used to set the iris level when the IRIS MODE is set to "MANUAL". Increase the number : open iris Decrease the number : close iris
SHUTTER	[STEP] V.SCAN RANDOM EEI OFF	Used to switch the shutter mode. STEP: The shutter speed can be changed with the [SPEED] item. V. SCAN: The shutter speed can be changed with the [SPEED] item. Enables more detailed setting than [STEP]. RANDOM: Used to synchronize the CCD accumulation timing with the trigger input. The shutter speed can be changed with the [SPEED] item. EEI: Used to automatically change the shutter speed in accordance with the brightness of the subject. OFF: Fixed at 1/7.5 s.
SPEED When "STEP" is selected	4s 2s 1s 1/2s 1/4s [1/8s] 1/15s 1/30s 1/60s 1/125s 1/250s 1/500s 1/1000s 1/2000s	The shutter speed can be changed when SHUTTER is set to "STEP", "V.SCAN" or "RANDOM".

5. Menu screen settings (continued)

MENU (QUICK) screen (continued)

[] indicates the factory setting

Item	Set Value	Contents
SHUTTER		<p>MEMO</p> <ul style="list-style-type: none"> When the shutter speed is slower than 1/7.5 s, the following phenomena may occur. <ol style="list-style-type: none"> The screen update rate becomes longer in the case of digital output. The displayed image will appear intermittently in the case of analog output. Time will be required for the auto white, auto iris and ALC operations. If the shutter speed is set slower than 1 s, these operations will behave as follows. <ul style="list-style-type: none"> Auto white : Auto white balance function cannot be started. (→ page E23 White balance adjustment) Auto iris : Stops at the iris value at that time. ALC : Stops at the sensitivity at that time. To use a shutter speed slower than 1 s, use with the following settings selected: <ul style="list-style-type: none"> IRIS MODE : MANUAL GAIN : STEP or V.GAIN There may be shortage of light when the shutter speed is increased. In this case, adjust the iris or sensitivity. Attention should be paid to the picture quality when the sensitivity is raised since the image becomes coarse.
SPEED When "V.SCAN" is selected	3.990s • • [1/7.501s] • • 1/5906.836s	
SPEED When "RANDOM" is selected	1/7.500s • [1/126.134s] • • 1/5648.193s	
GAIN	[STEP] ALC V.GAIN	Used to switch the sensitivity mode. STEP: The sensitivity can be changed with the "LEVEL" item. ALC: The sensitivity is automatically changed in accordance with ambient brightness. V. GAIN: The sensitivity can be changed in detail with the "LEVEL" item.
LEVEL When "STEP" is selected	[0dB] +6dB +12dB	
LEVEL When "V. GAIN" is selected	[0dB] +0.2dB +0.4dB • • +12dB	
FOCUS	0 1 • [128] • 255	Selects the focus position. Increasing the value: Focus far away Decreasing the value: Focus nearby
ZOOM	0 1 • [128] • 255	Selects the zoom position. Increasing the value: Toward telephoto Decreasing the value: Toward wide-angle

Resetting menu settings

This settings made on the menu screens can be returned to the initial settings as when shipped from the factory.

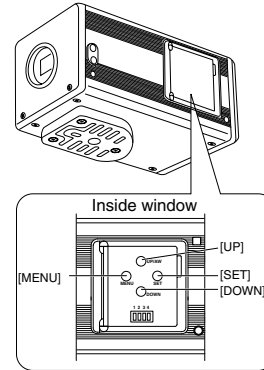

1. Open the side switch panel, and press the [MENU] button for 2 seconds or longer.
The [MENU] screen appears on the monitor screen.

2. Press the [UP] or [DOWN] button to select [5. SYSTEM SETTING] (displayed in purple when selected), and then press the [SET] button.
The [SYSTEM SETTING] screen appears.

3. Press the [UP] or [DOWN] button to select [MENU RESET] (displayed in purple when selected), and then press the [SET] button.
The [MENU RESET] screen appears.

4. When the [SET] button is pressed, all the menu settings are returned to the initial settings.
At this time, the "MENU RESET OK" message appears for about 3 seconds before the [SYSTEM SETTING] screen returns.

5. Press the [MENU] button again to return to the normal screen.

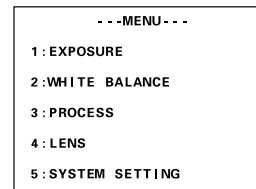

MENU screen

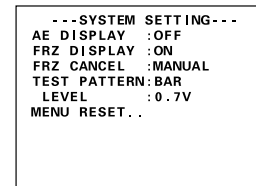

SYSTEM SETTING screen

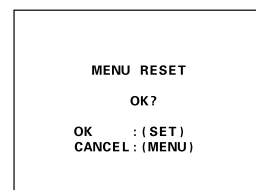

MENU RESET screen

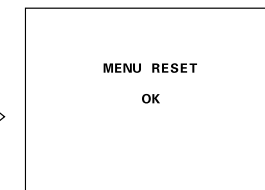
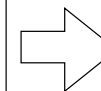

Completion screen

6. Others

About ALC and EEI operations

ALC stands for Automatic Level Control and EEI for Extended Electronic Iris. (☞ page E34)
By making the respective settings, the Automatic Level Control (ALC) will operate under dark lighting, and the electronic shutter (EEI) will operate under bright lighting. Furthermore, setting the IRIS mode to AUTO will synchronize sensitivity, iris and electronic shutter so that an appropriate signal level can be acquired automatically at all times.

The ALC mode increases sensitivity from 0dB to +12dB under dark lighting and the EEI mode automatically adjusts the range of 1/7.5 s to 1/2384.7 s (calculated value) under bright lighting. In other words, the signal level is adjusted in the range of 2 graduations of the aperture under dark lighting and 8 graduations under bright lighting. When the IRIS mode is set to manual, the sensitivity and electronic shutter change continuously while the iris setting stays fixed. (☞ page E33 IRIS MODE)

This feature holds the advantage of being able to shoot under changing light conditions without the depth of field altering.

MEMO

- The status of ALC and EEI can be displayed on the screen. (☞ page E40 AE DISPLAY)
- When EEI is used, the amount of change in one step of the signal level will be large and the precision becomes bad as the shutter speed is faster.
- When analog output is used, and EEI LIMIT is set to 1s when a dark subject is shot, the image will appear intermittently so the 1/7.5s setting should be used.

Operational range (when ALC MAX: +12dB)

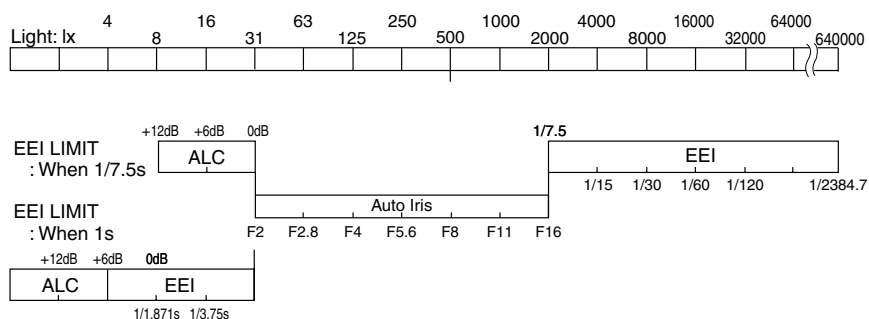

Specifications

Imaging device:	1/2 inch IT CCD
Scanning type:	Progressive
Available pixels:	1.45 million pixels (1392 (H) × 1040 (V))
Effective no. of pixels:	ANALOG : 1360 × 1024 DIGITAL : 1280 × 960 1360 × 1024
Aspect ratio:	Approx. 4:3
SHUTTER speed:	3.990s to 1/5960.836s
Lens mount:	C mount
Analog output:	R/G/B signal: 0.7V (p-p), 75 Ω
Digital output:	IEEE1394 – 1995 (IIDC 1394-based Digital Camera Specification Ver. 1.30 standard)
Synchronization:	internal
Sync signal output:	Hs, Vs 3.3V (p-p) negative polarity or SYNC ON GREEN 0.3V (p-p)
Operating temperature range:	0°C to 40°C (with humidity of less than 80%RH)
Input voltage:	DC 12V ∴ (when AA-P700 is used) DC8V to 40V ∴ (IEEE1394 power supply)
Power consumption:	8 W (when AA-P700 is used, including lens) 3.2 W (when AA-P700 is used, camera in stand-alone use) 2.5 W (when IEEE1394 power supply +12V)
Mass:	Approx. 470g

Connectable PC models:

- Pentium III 1 GHz or higher DOS/V, PC/AT compatible machine (Pentium 4 1.3 GHz or higher is recommended*)
- Memory 64 MB or more
- 20 MB or more empty hard disk space (space for application software install)
- OS: Windows 98SE/Me/2000
- Video circuit: Circuit capable of full-color display at XGA (1024 x 768) or higher resolution (UXGA 1600 x 1200 or higher is recommended*)

- More than one empty PCI slot (Ver. 2.1)

* When the recommended conditions are not met, the image may stretch outside the screen depending on the image size, or the display frame rate may become slow.

Connectable peripheral equipment

- Video Capture Board
MATROX METEOR2-MC/4
- IEEE1394 Host Adapter Board
TECHNOSCOPE PFW-41
- Scan Rate Converter
JVC KM-F700
- Options
- Lens: D16 x 7.3A – D29
- AC Adapter: AA-P700

Specifications

External dimensions (unit: mm)

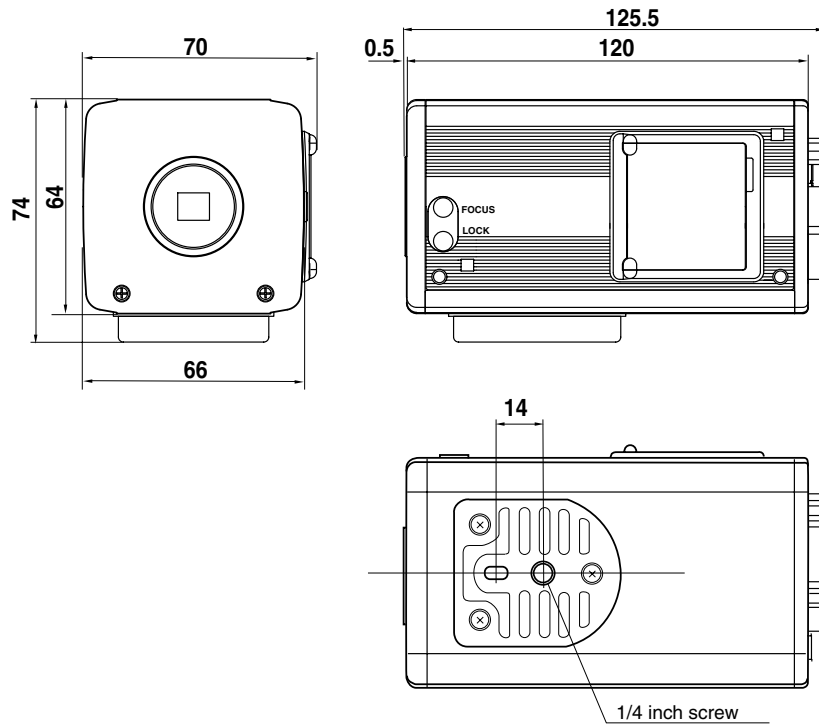

Design and specifications are subject to change without notice.