

TOSHIBA



DVD VIDEO PLAYER & VIDEO CASSETTE RECORDER

SD-V390-S-TU

OWNER'S MANUAL

VHS Hi-Fi

Before connecting, operating or adjusting this product,
please read this instruction booklet carefully and completely.



Safety Precautions



CAUTION
RISK OF ELECTRIC SHOCK
DO NOT OPEN



CAUTION: TO REDUCE THE RISK OF ELECTRIC SHOCK DO NOT REMOVE COVER (OR BACK) NO USER-SERVICEABLE PARTS INSIDE REFER SERVICING TO QUALIFIED SERVICE PERSONNEL.



This lightning flash with arrowhead symbol within an equilateral triangle is intended to alert the user to the presence of uninsulated dangerous voltage within the product's enclosure that may be of sufficient magnitude to constitute a risk of electric shock to persons.



The exclamation point within an equilateral triangle is intended to alert the user to the presence of important operating and maintenance (servicing) instructions in the literature accompanying the product.

WARNING: TO REDUCE THE RISK OF FIRE OR ELECTRIC SHOCK, DO NOT EXPOSE THIS APPARATUS TO RAIN OR MOISTURE.

CAUTION: TO PREVENT ELECTRIC SHOCK, MATCH WIDE BLADE OF PLUG TO WIDE SLOT, FULLY INSERT.

ATTENTION: POUR ÉVITER LES CHOC ÉLECTRIQUES, INTRODUIRE LA LAME LA PLUS LARGE DE LA FICHE DANS LA BORNE CORRESPONDANTE DE LA PRISE ET POUSSER JUSQU'AU FOND.

WARNING: Do not install this equipment in a confined space such as a book case or similar unit.

NOTE TO CABLE/TV INSTALLER: This reminder is provided to call the cable TV system installer's attention to Article 820-40 of the National Electric Code (U.S.A.). The code provides guidelines for proper grounding and, in particular, specifies that the cable ground shall be connected to the grounding system of the building, as close to the point of the cable entry as practical.

CAUTION:

This DVD+VCR employs a Laser System.

To ensure proper use of this product, please read this owner's manual carefully and retain for future reference should the unit require maintenance, contact an authorized service location.

Use of controls, adjustments, or the performance of procedures other than those specified herein may result in hazardous radiation exposure.

To prevent direct exposure to laser beam, do not try to open the enclosure. Visible laser radiation when open. DO NOT STARE INTO BEAM.

CAUTION: The apparatus should not be exposed to water (dripping or splashing) and no objects filled with liquids, such as vases, should be placed on the apparatus.

FCC WARNING: This equipment may generate or use radio frequency energy. Changes or modifications to this equipment may cause harmful interference unless the modifications are expressly approved in the instruction manual. The user could lose the authority to operate this equipment if an unauthorized change or modification is made.

REGULATORY INFORMATION: FCC Part 15

This product has been tested and found to comply with the limits for a Class B digital device, pursuant to Part 15 of the FCC Rules. These limits are designed to provide reasonable protection against harmful interference when the product is operated in a residential installation. This product generates, uses, and can radiate radio frequency energy and, if not installed and used in accordance with the instruction manual, may cause harmful interference to radio communications. However, there is no guarantee that interference will not occur in a particular installation. If this product does cause harmful interference to radio or television reception, which can be determined by turning the product off and on, the user is encouraged to try to correct the interference by one or more of the following measures:

- Reorient or relocate the receiving antenna.
- Increase the separation between the product and receiver.
- Connect the product into an outlet on a circuit different from that to which the receiver is connected.
- Consult the dealer or an experienced radio/TV technician for help.



NOTES ON COPYRIGHTS:

It is forbidden by law to copy, broadcast, show, broadcast via cable, play in public, or rent copyrighted material without permission.

This product features the copy protection function developed by Macrovision. Copy protection signals are recorded on some discs. When recording and playing the pictures of these discs on a VCR, picture noise will appear.

This product incorporates copyright protection technology that is protected by method claims of certain U.S. patents and other intellectual property rights owned by Macrovision Corporation and other rights owners. Use of this copyright protection technology must be authorized by Macrovision Corporation, and is intended for home and other limited viewing uses only unless otherwise authorized by Macrovision Corporation. Reverse engineering or disassembly is prohibited.

SERIAL NUMBER: The serial number is found on the back of this unit. This number is unique to this unit and not available to others. You should record requested information here and retain this guide as a permanent record of your purchase.

Model No. _____

Serial No. _____

IMPORTANT SAFETY INSTRUCTIONS

CAUTION: PLEASE READ AND OBSERVE ALL WARNINGS AND INSTRUCTIONS IN THIS OWNER'S MANUAL AND THOSE MARKED ON THE UNIT. RETAIN THIS BOOKLET FOR FUTURE REFERENCE.

This set has been designed and manufactured to assure personal safety. Improper use can result in electric shock or fire hazard. The safeguards incorporated in this unit will protect you if you observe the following procedures for installation, use, and servicing.

This unit does not contain any parts that can be repaired by the user. **DO NOT REMOVE THE CABINET COVER, OR YOU MAY BE EXPOSED TO DANGEROUS VOLTAGE. REFER SERVICING TO QUALIFIED SERVICE PERSONNEL ONLY.**

1. Read These Instructions

All safety and operating instructions should be read before the product is operated.

2. Follow All Instructions

All operating and use instructions should be followed.

3. Keep These Instructions

The safety and operating instructions should be retained for future reference.

4. Heed All Warnings

All warnings on the product and in the operating instructions should be adhered to.

5. Power Sources

This product should be operated only from the type of power source indicated on the marking label. If you are not sure of the type of power supply in your home, consult your product dealer or local power company. For products intended to operate from battery power, or other sources, refer to the operating instructions.

6. Grounding or Polarization

Do not defeat the safety purpose of the polarized plug has two blades with one wider than the other. A grounding-type plug has two blades and a third grounding prong. The wide blade or the prong are provided for your safety. If the provided plug does not fit into your outlet, consult an electrician for replacement of the obsolete outlet.

7. Ventilation

Slots and openings in the cabinet are provided for ventilation and to ensure reliable operation of the product and to protect it from overheating. These openings must not be blocked or covered. The openings should never be blocked by placing the product on a bed, sofa, rug or other similar surface. This product should not be placed in a built-in installation such as a bookcase or rack unless proper ventilation is provided or the manufacturer's instructions have been adhered to.

8. Heat

Do not install near any heat sources such as radiators, heat registers, stoves, or other apparatus (including amplifiers) that produce heat.

9. Water and Moisture

Do not use this apparatus near water. For example: near a bath tub, wash bowl, kitchen sink, Laundry tub, in a wet basement; or near a swimming pool.

10. Cleaning

Unplug this product from the wall outlet before cleaning. Do not use liquid cleaners or aerosol cleaners. Clean only with dry cloth.

11. Power-Cord Protection

Protect the power cord from being walked on or pinched particularly at plugs, convenience receptacles, and the point where they exit from the apparatus.

12. Overloading

Do not overload wall outlets, extension cords, or integral convenience receptacles, this can result in a risk of fire or electric shock.

13. Lightning

Unplug this apparatus during lightning storms or when unused for long periods of time. This will prevent damage to the product due to lightning and power-line surges.

14. Object and Liquid Entry

Never push objects of any kind into this product through openings as they may touch dangerous voltage points or short-out parts that could result in a fire or electric shock. Never spill liquid of any kind on the product.

15. Attachments

Only use attachments/accessories specified by the manufacturer.

16. Accessories

Use only with the cart, stand, tripod, bracket, or table specified by the manufacturer or sold with the apparatus. When a cart is used, use caution when moving the cart/apparatus combination to avoid injury from tip-over.



PORTABLE CART
WARNING

17. Disc Tray

Keep your fingers well clear of the disc tray as it is closing. It can cause personal injury.

18. Burden

Do not place a heavy object on or step on the product. The object may fall, causing serious personal injury and serious damage to the product.

19. Connecting

When you connect the product to other equipment, turn off the power and unplug all of the equipment from the wall outlet. Failure to do so may cause an electric shock and serious personal injury. Read the owner's manual of the other equipment carefully and follow the instructions when making any connections.

20. Sound Volume

Reduce the volume to the minimum level before you turn on the product. Otherwise, sudden high volume sound may cause hearing or speaker damage.

21. Sound Distortion

Do not allow the product to output distorted sound for a long time. It may cause speaker overheating and fire.

22. Earphone

When you use the earphone, keep the volume at a moderate level. If you use the earphone continuously with high volume sound, it may cause hearing damage.

23. Laser Beam

Do not look into the opening of the disc tray or ventilation opening of the product to see the source of the laser beam. It may cause sight damage.

24. Disc

Do not use a cracked, deformed, or repaired disc. These discs are easily broken and may cause serious personal injury and product malfunction.

25. Damage Requiring Service

Refer all servicing to qualified service personnel. Servicing is required when the apparatus has been damaged in any way, such as power-supply cord or plug is damaged, liquid has been spilled or objects have fallen into the apparatus, the apparatus has been exposed to rain or moisture, does not operate normal, or has been dropped.

26. Servicing

Do not attempt to service this product yourself as opening or removing the cover may expose you to dangerous voltage or other hazards. Refer all servicing to qualified service personnel.

27. Replacement parts

When replacement parts are required, be sure the service technician has used replacement parts specified by the manufacturer or have the same characteristics as the original part. Unauthorized substitutions may result in fire, electric shock, or other hazards.

28. Safety Check

Upon completion of any service or repairs to this product, ask the service technician to perform safety checks to determine that the product is in proper operating condition.

Table of Contents

Introduction

Safety Precautions	2
IMPORTANT SAFETY INSTRUCTIONS	3
Table of Contents	4
Before Use	5-6
Playable Discs	5
Precautions	6
Notes on Discs	6
About Symbols	6
Front Panel	7
Display Window	8
Remote Control	9
Rear Panel	10

Preparation

Connections	11-14
Connecting Antenna/Cable TV to a DVD+VCR	11
Basic TV Connections	12
Optional, Preferred TV Connections	13-14
Before Operation - VCR Part	15-17
On-Screen Display(OSD)	15
Setting the On-Screen Display	15
Setting the VCR Setup Menu	16
Channel Selection	16
Setting the Clock	17
Before Operation - DVD Part	18-21
General Explanation	18
On-Screen Display	18
Initial Settings	19-22
• <i>General Operation</i>	19
• <i>Language</i>	19
• <i>Picture</i>	19
• <i>Sound</i>	20
• <i>Others</i>	20
• <i>Parental Control</i>	21

Operation



Operation with tape	22-28
Normal Playback	22
Special Effect Playbacks	22
• <i>Search</i>	22
• <i>Still Picture and Frame-by-Frame Playback</i>	22
• <i>Slow Motion</i>	22
• <i>Instant Skip</i>	22
VISS (VHS Index Search System)	23
Normal Recording	23
Timer Recording	24-25
One touch Timer Recording(OTR)	25
Dubbing and Editing	26
Copying from DVD to VCR	26
VHS Hi-Fi Stereo System/MTS Broadcast	27
Tape Counter Memory Feature	28
Additional Information	28
• <i>S-VHS Quasi Playback (SQPB)</i>	28
• <i>Auto Play System</i>	28
• <i>Video Head Cleaning</i>	28
• <i>Blank Search</i>	28
Operation with DVD and Video CD	29-32
Playing DVD and Video CD	29
General Features	29
• <i>Moving to another TITLE</i>	29
• <i>Moving to another CHAPTER</i>	29
• <i>Slow Motion</i>	29
• <i>Still Picture and Frame-by-Frame Playback</i>	30
• <i>Search</i>	30
• <i>Random</i>	30

• <i>Time Search</i>	30
• <i>Selecting the sound enhancement</i>	30
• <i>Repeat</i>	31
• <i>Repeat A-B</i>	31
• <i>Zoom</i>	31
• <i>Marker Search</i>	31
Special DVD Features	32
• <i>Checking the contents of DVD Video discs: Menus</i>	32
• <i>Title Menu</i>	32
• <i>Disc Menu</i>	32
• <i>Camera Angle</i>	32
• <i>Changing the Audio Language</i>	32
• <i>Changing the Audio Channel</i>	32
• <i>Subtitle</i>	32
Operation with Audio CD	33
Playing an Audio CD	33
• <i>Pause</i>	33
• <i>Moving to another Track</i>	33
• <i>Repeat Track/ All/ Off</i>	33
• <i>Search</i>	33
• <i>Random</i>	33
• <i>Repeat A-B</i>	33
• <i>Selecting the sound enhancement</i>	33
• <i>Changing the Audio Channel</i>	33
Operation with MP3 Disc	34
Playing an MP3 disc	34
• <i>Pause</i>	34
• <i>Moving to another Track</i>	34
• <i>Repeat Track/ All/ Off</i>	34
Notes on MP3 Discs	34
Operation with JPEG Disc	35
Viewing a JPEG disc	35
• <i>Moving to another File</i>	35
• <i>Repeat All/ Off</i>	35
Operation with WMA Disc	36
Playing an WMA disc	36
• <i>Pause</i>	36
• <i>Moving to another Track</i>	36
• <i>Repeat Track/ All/ Off</i>	36
Programmed Playback	37
Programmed Playback with Audio CD, MP3	
JPEG and WMA Discs	37
Programmed Playback with Video CD	37
• <i>Repeat Programmed Tracks/All/Off</i>	38
• <i>Repeat Programmed All/Off</i>	38
• <i>Erasing a Track/File from Program List</i>	38
• <i>Erasing the Complete Program List</i>	38
Additional Information - DVD Part	39
One Touch Replay	39
Screen Saver	39
Video Mode Setting	39

Reference



Troubleshooting	40-41
Language Code List	42
Country/Area Code List	43
Specifications	44
Warranty	45-46

About the symbols for instructions

-  Indicates hazards likely to cause harm to the unit itself or other material damage.
-  Indicates special operating features of this unit.
-  Indicates tips and hints for making the task easier.

Before Use

Playable Discs

	DVD (8 cm/12 cm disc)
	Video CD (VCD) (8 cm / 12 cm disc)
	Audio CD (8 cm/12 cm disc)

In addition, this unit can play a DVD-R, CD-R or CD-RW that contains audio titles, MP3 or JPEG files.

Notes

- Depending on the conditions of the recording equipment or the CD-R/RW disc itself, some CD-R/RW discs cannot be played on the unit.
- The unit cannot play discs that contain data other than MP3 and CD-DA data.
- Do not attach any seal or label to either side (the labeled side or the recorded side) of a disc.
- Do not use irregularly shaped CDs (e.g., heart-shaped or octagonal). It may result in malfunctions.

Notes on DVDs and Video CDs

Some playback operations of DVDs and Video CDs may be intentionally fixed by software manufacturers. As this unit plays DVDs and Video CDs according to disc content designed by the software manufacturer, some playback features of the unit may not be available, or other functions may be added. Refer also to the instructions supplied with the DVDs and Video CDs. Some DVDs made for business purposes may not be playable on this unit.

Regional code of the DVD+VCR and DVDs

This DVD+VCR is designed and manufactured for playback of region 1 encoded DVD software. The region code on the labels of some DVD discs indicates which type of DVD+VCR can play those discs. This unit can play only DVD discs labeled 1 or ALL. If you try to play any other discs, the message “Check Regional Code” will appear on the TV screen. Some DVD discs may not have a region code label even though their playback is prohibited by area limits.



Note on DTS-encoded CDs

When playing DTS-encoded CDs, excessive noise may be exhibited from the analog stereo output. To avoid possible damage to the audio system, turn down the volume before playing back such discs, adjust the volume gradually, and keep the volume level low. To enjoy DTS Digital Surround™ playback, an external 5.1 channel DTS Digital Surround™ decoder system must be connected to the digital output of the unit.

Disc-related terms

Title (DVD only)

The main film content or accompanying feature content or music album.

Each title is assigned a title reference number enabling you to locate it easily.

Chapter (DVD only)

Sections of a picture or a musical piece that are smaller than titles. A title is composed of one or several chapters. Each chapter is assigned a chapter number to enable you to locate the chapter you want. Depending on the disc, chapters may not be recorded.

Track (Video CD and audio CD only)

Sections of a picture or a musical piece on a video CD or an audio CD. Each track is assigned a track number, enabling you to locate the track you want.

Scene

On a video CD with PBC (Playback control) functions, moving pictures and still pictures are divided into sections called “Scenes”. Each scene is displayed in the menu screen and assigned a scene number, enabling you to locate the scene you want. A scene is composed of one or several tracks.

Types of video CDs

There are two types of video CDs:

Video CDs equipped with PBC (Version 2.0)



PBC (Playback control) functions allow you to interact with the system via menus, search functions, or other typical computer-like operations. Moreover, still pictures of high resolution can be played if they are included in the disc.

Video CDs not equipped with PBC (Version 1.1)

Operated in the same way as audio CDs, these discs allow playback of video pictures as well as sound, but they are not equipped with PBC.

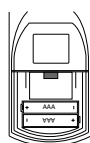
Remote control battery installation



Detach the battery cover on the rear of the remote control, and insert two R03 (size AAA) batteries with  and  aligned correctly.

Caution

Do not mix old and new batteries. Never mix different types of batteries (standard, alkaline, etc.).

Remote Control Operation Range

Point the remote control at the remote sensor and press the buttons.

- **Distance:** About 23 ft (7 m) from the front of the remote sensor
- **Angle:** About 30° in each direction of the front of the remote sensor

Before Use (Continued)

Precautions

Handling the unit

When shipping the unit

The original shipping carton and packing materials come in handy. For maximum protection, re-pack the unit as it was originally packaged at the factory.

When setting up the unit

The picture and sound of a nearby TV, VCR, or radio may be distorted during playback. In this case, position the unit away from the TV, VCR, or radio, or turn off the unit after removing the disc.

To keep the surface clean

Do not use volatile liquids, such as insecticide spray, near the unit. Do not leave rubber or plastic products in contact with the unit for a long period of time. They will leave marks on the surface.

Cleaning the unit

To clean the cabinet

Use a soft, dry cloth. If the surfaces are extremely dirty, use a soft cloth lightly moistened with a mild detergent solution. Do not use strong solvents such as alcohol, benzene, or thinner, as these might damage the surface of the unit.

To obtain a clear picture

The DVD+VCR is a high-tech, precision device. If the optical pick-up lens and disc drive parts are dirty or worn, the picture quality will be poor. Regular inspection and maintenance are recommended after every 1,000 hours of use. (This depends on the operating environment.) For details, please contact your nearest dealer.

Notes on Discs

Handling discs

Do not touch the playback side of the disc. Hold the disc by the edges so that fingerprints will not get on the surface. Do not stick paper or tape on the disc.

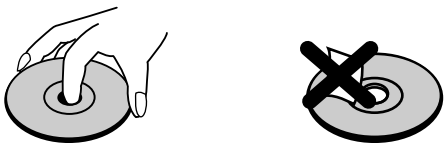

Storing discs

After playing, store the disc in its case. Do not expose the disc to direct sunlight or sources of heat, or leave it in a parked car exposed to direct sunlight, as there may be a considerable temperature increase inside the car.

Cleaning discs

Fingerprints and dust on the disc can cause poor picture quality and sound distortion. Before playing, clean the disc with a clean cloth. Wipe the disc from the center out.

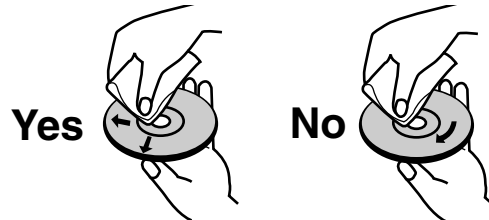

Do not use strong solvents such as alcohol, benzene, thinner, commercially available cleaners, or anti-static spray intended for older vinyl records.





About Symbols

About the symbol display

“” may appear on the TV screen during operation. This icon means the function explained in this owner’s manual is not available on that specific DVD video disc.

About the disc symbols for instructions

A section whose title has one of the following symbols are applicable only to those discs represented by the symbol.

-  DVD DVD
-  VCD2.0 Video CDs with the PBC (playback control) function.
-  VCD1.1 Video CDs without the PBC (playback control) function.
-  CD Audio CDs.
-  MP3 MP3 Discs.

Setting the Output Source

You must select one of your output sources (DVD or VCR) to view on the TV screen.

- **If you want to view output source of DVD deck:**
Press DVD on the remote or DVD/VCR on the front panel until DVD indicator in the display window lights and output source of DVD deck is viewed on the TV screen.
- **If you want to view output source of VCR deck:**
Press VCR on the remote or DVD/VCR on the front panel until VCR indicator in the display window lights and output source of VCR deck is viewed on the TV screen.

NOTES

- If you insert a disc when the DVD+VCR is in the VCR mode, the DVD+VCR will be set to DVD mode automatically.
- If you insert a cassette tape without prevention tab when the DVD+VCR is in the DVD mode, the DVD+VCR will be set to VCR mode automatically.

Front Panel

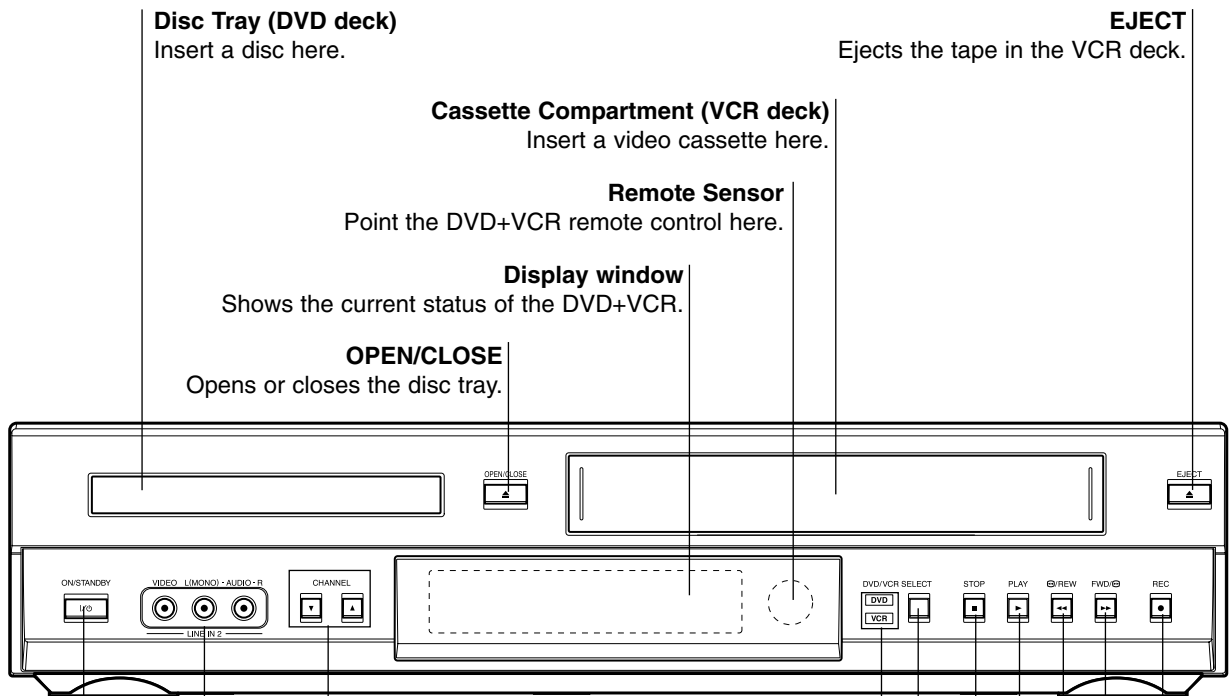

Disc Tray (DVD deck)
Insert a disc here.

EJECT
Ejects the tape in the VCR deck.

Cassette Compartment (VCR deck)
Insert a video cassette here.

Remote Sensor
Point the DVD+VCR remote control here.

Display window
Shows the current status of the DVD+VCR.

OPEN/CLOSE
Opens or closes the disc tray.

CHANNEL (▲/▼)
To scan up or down through memorized channels.

DVD/VCR indicator
Indicates the active deck.

DVD/VCR SELECT
Toggles control between the DVD deck and the VCR deck.

LINE 2 (VIDEO IN/AUDIO IN (Left/Right))
Connect the audio/video output of an external source (Audio system, TV/Monitor, Another VCR).

STOP
Stops playback.

PLAY
To play back a recorded tape.

ON/STANDBY
Switches the DVD+VCR ON and OFF.

REW
DVD: Go to beginning of current chapter/track or to previous chapter/track. Press and hold for a fast reverse search.
VCR: Rewinds the tape during the STOP mode or for fast reverse picture search.

FWD
DVD: Go to NEXT chapter/track. Press and hold for two seconds for a fast forward search.
VCR: Advances the tape during the STOP mode or for fast forward picture search.

REC
To record normally or to activate One-touch Timer Recording by repeated presses.

Display Window

DVD DVD inserted.

VCD Video CD inserted

CD Audio CD inserted.

A ↔ B Indicates A-B repeat mode.

ALL Indicates repeat all mode.

 **ANGLE** active.

MP3 MP3 disc inserted.

PROG. Programmed playback active.

TITLE Indicates current title number.

CHP/TRK Indicates current chapter or track number.

VCR DVD+VCR functions are available and channels are selected at DVD+VCR.

TIMER DVD+VCR is in timer recording or a timer recording is programmed.

REC DVD+VCR is Recording.

CDREC DVD to VCR copy is in progress.

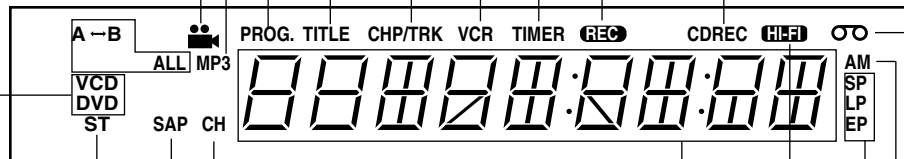

CH DVD+VCR is tuned to Channel XX.

SAP Indicates when a SAP BILINGUAL broadcast is being received.

ST Indicates a stereo broadcast is being received.

Indicates total playing time, elapsed time, remaining time or current deck status (Playback, Pause, etc).

HI-FI Indicates the unit is playing back a tape recorded in Hi-Fi.

SP LP EP Displays the recording and playback speed.

AM Indicates AM time. (PM is not displayed.)

A cassette is in the VCR deck.

Remote Control

DVD/VCR select button
Select the output source (DVD or VCR) to view on the TV screen.

0-9 numerical buttons
Selects numbered options in a menu.

INPUT SELECT
To select the VCR deck's source (Tuner, LINE 1, or LINE 2).

ANGLE ●
Selects a DVD camera angle if available.

SUBTITLE ●
Selects a subtitle language.

AUDIO ●
Selects an audio language (DVD) or an audio channel (CD).

INSTANT REPLAY ●
Replays through 10 seconds of playback.

PLAY ●
Starts playback.

REW ●
Rewinds the tape during the STOP mode or for fast reverse picture search.

FWD ●
Advances the tape during the STOP mode or for fast forward picture search.

SLOW ●
Forward slow playback of tape.

STOP ●
Stops playback.

PAUSE/STILL, PAUSE/STEP ●
Pause playback or recording temporarily/press repeatedly for frame-frame playback.

SKIP ●
Skip to beginning of current chapter or track, press twice in quick successions to go to previous chapter or track. Press and hold button for about two seconds to search backward. (For DVD only)

SKIP ●
Skip to next chapter or track. Press and hold button for about two seconds to search backward. (For DVD only)

SETUP, VCR MENU
Accesses or removes DVD setup menu and VCR menu.

TV/VCR
To view channels selected by the VCR tuner or by the TV tuner.

Left/Right/Up/Down ●
- Selects an option in the menu
- **CH/TRK (+/-)**: Selects channel of VCR. Adjusts manually the tape's picture onscreen.

ENTER ●
- Acknowledges menu selection.
- Displays functions on the TV screen.

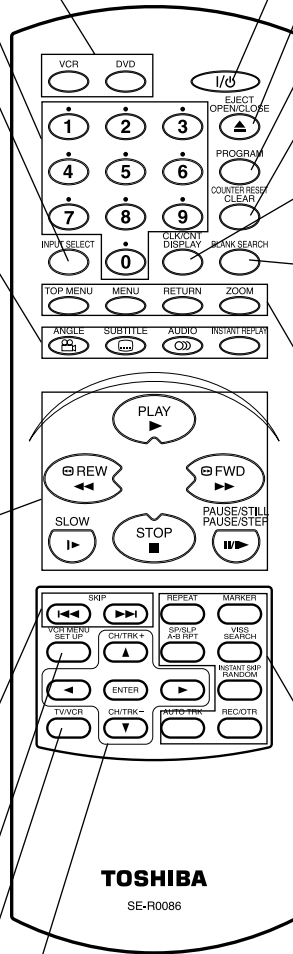

POWER
Switches DVD+VCR ON and OFF.

EJECT, OPEN/CLOSE
- Opens and closes the disc tray.
- Ejects the tape in the VCR deck.

PROGRAM
Accesses or removes Program menu.

COUNT RESET, CLEAR
- Resets tape counter to M 0:00:00
- Removes a track number on the program menu or a mark on the MARKER SEARCH menu.

CLK/CNT, DISPLAY
Accesses On-Screen display. Switches among the clock, tape counter and tape remaining modes on the display.

BLANK SEARCH
Finds end points of recording.

● **TOP MENU**
Displays the disc's Title menu, if available.

● **MENU**
Accesses menu on a DVD disc.

● **RETURN**
- Removes the setup menu.
- Displays the menu of a video CD with PBC.

● **ZOOM**
Enlarges DVD video image.

● **REPEAT**
Repeat chapter, track, title, all.

● **A-B REPEAT, SP/SLP**
- Repeats sequence.
- Selects recording speed

● **MARKER**
Marks any point during playback.

● **VISS, SEARCH**
- Enters the VISS function mode.
- Displays MARKER SEARCH menu.

● **RANDOM, INSTANT SKIP**
- Plays tracks in random order.
- Fast forwards picture search through 30 seconds of recording.

● **REC/OTR**
Records normally or activates One touch Timer Recording with repeated presses.

● **AUTO TRK**
Adjusts automatically the tape's picture onscreen.

Note

This remote control use the same buttons for VCR and DVD functions (ex. PLAY).
When using a VCR, first press the VCR button.
When using a DVD, first press the DVD button.

Rear Panel

DVD/VCR OUT (VIDEO/AUDIO (Left/Right))
Connect to a TV with video and audio inputs.

COMPONENT OUT (Y Pb Pr)
Connect to a TV with Y Pb Pr inputs.

LINE 1 (VIDEO IN/AUDIO IN (Left/Right))
Connect the audio/video output of an external source (Audio system, TV/Monitor, Another VCR).

ANALOG OUT (Left/Right) (DVD OUT)
Connect to a TV, amplifier, receiver, or stereo system.

S-VIDEO OUT (DVD OUT)
Connect to a S-Video Input on TV.

Video Output Select Switch
Select either S-VIDEO or COMPONENT, depending on how you connect DVD Player to the TV.

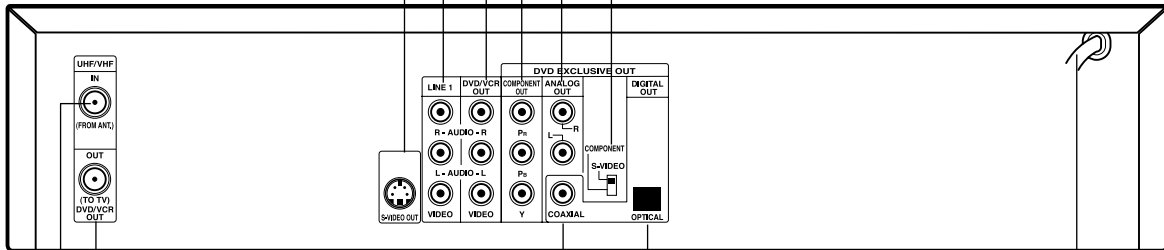

AC Power Cord
Plug into the power source.

DIGITAL AUDIO OUT (OPTICAL) (DVD OUT)
Connect to digital (optical) audio equipment.

UHF/VHF OUT (DVD/VCR OUT)
Connect to a TV with RF coaxial inputs.

DIGITAL AUDIO OUT (COAXIAL) (DVD OUT)
Connect to digital (coaxial) audio equipment.

UHF/VHF IN (ANTENNA INPUT)
Connect the VHF/UHF/CATV antenna to this terminal.



Do not touch the inner pins of the jacks on the rear panel. Electrostatic discharge may cause permanent damage to the unit.

Connections

Tips

- Depending on your TV and other equipment you wish to connect, there are various ways you could connect the DVD+VCR. Use connections described on pages 11-14.
- Please refer to the manuals of your TV, VCR, Stereo System or other devices as necessary to make the best connections.
- For better sound reproduction, connect the DVD+VCR's DVD/VHS AUDIO OUT jack to the audio in jacks of your amplifier, receiver, stereo or audio/video equipment. See *Optional, Preferred TV Connections* on page 13-14.

Caution

- Make sure the DVD+VCR is connected directly to the TV. Tune the TV to the correct video input channel.
- Do not connect the DVD+VCR's DVD/VHS AUDIO OUT jack to the phono in jack (record deck) of your audio system.
- Do not connect your DVD+VCR via your VCR. The DVD image could be distorted by the copy protection system.

Connecting Antenna/Cable TV to DVD+VCR

- 1 Disconnect the antenna leads from the rear of the TV.
- 2 Identify the type of cable from your antenna. If it is a round cable as illustrated, it is a 75 ohm coaxial antenna cable. This cable will connect directly to the jack marked ANT.IN on your DVD+VCR.

Tip

If your antenna lead wire is a flat type antenna cable, connect it to a Antenna Adaptor (300-ohm to 75-ohm) (not supplied) and slip the Adaptor onto the ANT.IN jack. The Adaptor does not screw on to the DVD+VCR, it just slips over the jack.

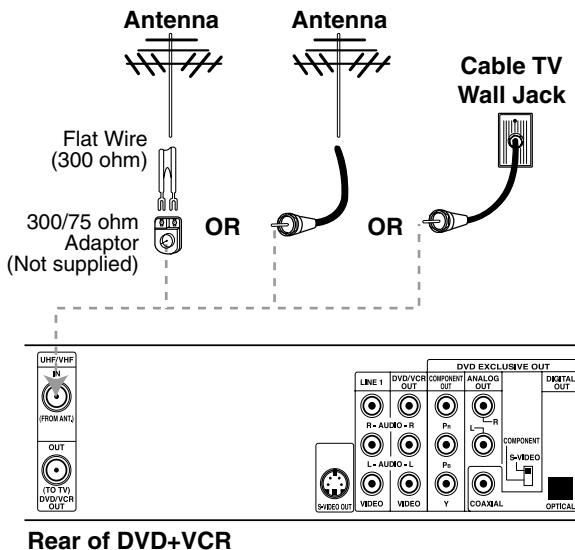

Without Cable Box

If your cable wire is connected to your TV without a converter or descrambler box, unscrew the wire from your TV and attach it to the ANT.IN jack on the DVD+VCR. Use the supplied round coaxial cable to connect between the DVD+VCR's RF.OUT jack and the 75 ohm antenna input jack on the TV. With this connection, you can receive all midband, super band, and hyperband channels.

With Cable Box

If a converter is required in your cable system, follow the instruction below:
The cable hookup permits both TV and DVD+VCR operation.

To view or record CATV channel

- 1 Tune the TV to the DVD+VCR output channel (CH 3 or 4).
- 2 Set the DVD+VCR channel selector to the output channel of the Cable Converter box by pressing the CH/TRK (+/-) or number (0-9) of your DVD+VCR. (Example: CH3)
- 3 Select the channel to view at the Cable Converter Box.

Notes

- With this connection, you CANNOT record one program while viewing another.
- If you are using a cable box to tune channels, it is not necessary to do Auto Channel Programming(Auto Channel Set) as indicated on page 16.

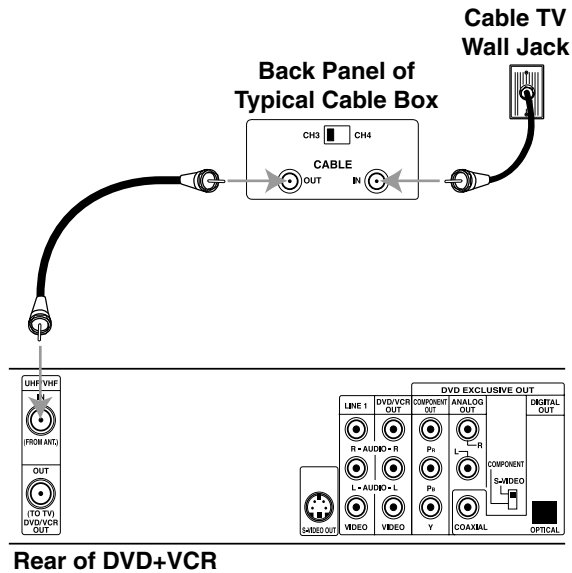

PREPARATION

Connections (Continued)

Basic TV Connections

- Make one of the following connections, depending on the capabilities of your existing equipment.

RF coaxial connection

Connect the RF.OUT jack on the DVD+VCR to the antenna in jack on the TV using the 75-ohm Coaxial Cable supplied (**R**).

Note

If you use this connection, tune the TV to the DVD+VCR's RF output channel (CH 3 or 4).

How to set the DVD+VCR's RF output channel

1. When the DVD+VCR is turned off, press and hold CHANNEL ▲ or CHANNEL ▼ on the front panel for about five seconds. It will turn itself on and "RF 03" or "RF 04" appears in the display window.
2. Press CHANNEL ▲ or CHANNEL ▼ on the front panel or CH/TRK (+/-) on the remote control to change the RF output channel (CH 03 or CH 04).
3. Turn off and on the DVD+VCR.
4. Press the TV CH to 3 or 4 depending on the RF output channel you had selected.
Now you can watch the DVD+VCR playback on CH3 or CH4 of your TV.

Audio/Video connection

- 1 Connect the DVD/VHS VIDEO OUT jack on the DVD+VCR to the video in jack on the TV using the video cable supplied (**V**).
- 2 Connect the Left and Right DVD/VHS AUDIO OUT jacks on the DVD+VCR to the audio left/right in jacks on the TV (**A1**) using the supplied audio cables.

Note

If you use this connection, set the TV's source selector to VIDEO.

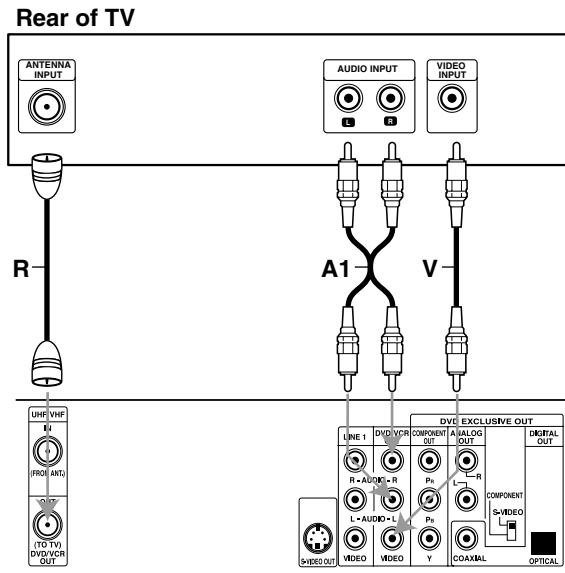

Rear of DVD+VCR

Connections (Continued)

Optional, Preferred TV Connections

Notes

- You can **ONLY** watch and listen to DVD playback through the connections shown below.
- **When using the COMPONENT VIDEO OUT jacks, set the video output select switch to COMPONENT. When using the S-VIDEO OUT jack, set the video output select switch to S-VIDEO.**

S-Video connection

- 1** Connect the S-VIDEO OUT jack on the DVD+VCR to the S-Video in jack on the TV using the optional S-Video cable (**S**).
- 2** Connect the Left and Right AUDIO OUT jacks of the DVD+VCR to the audio left/right in jacks on the TV using the supplied audio cables (**A2**).

Component Video (Color Stream®) connection

- 1** Connect the COMPONENT VIDEO OUT jacks on the DVD Player to the corresponding in jacks on the TV using an optional Y Pb Pr cable (**C**).
- 2** Connect the Left and Right AUDIO OUT jacks of the DVD+VCR to the audio left/right in jacks on the TV (**A2**) using the supplied audio cables.

Progressive Scan (ColorStream® pro) connection

- If your television is a high-definition or “digital ready” television, you may take advantage of the DVD Player’s progressive scan output for the highest video resolution possible.
 - If your TV does not accept the Progressive Scan format, the picture will appear scrambled if you select Progressive Scan output from the DVD Player.
- 1** Connect the COMPONENT VIDEO OUT jacks on the DVD Player to the corresponding in jacks on the TV using an optional Y Pb Pr cable (**C**).
 - 2** Connect the Left and Right AUDIO OUT jacks of the DVD Player to the audio left/right in jacks on the TV (**A2**) using the supplied audio cables.

Notes

- Set the Progressive to “On” from the setup menu, see page 19.
- Progressive scan does not function simultaneously with the analog video connections (yellow VIDEO OUT jack).

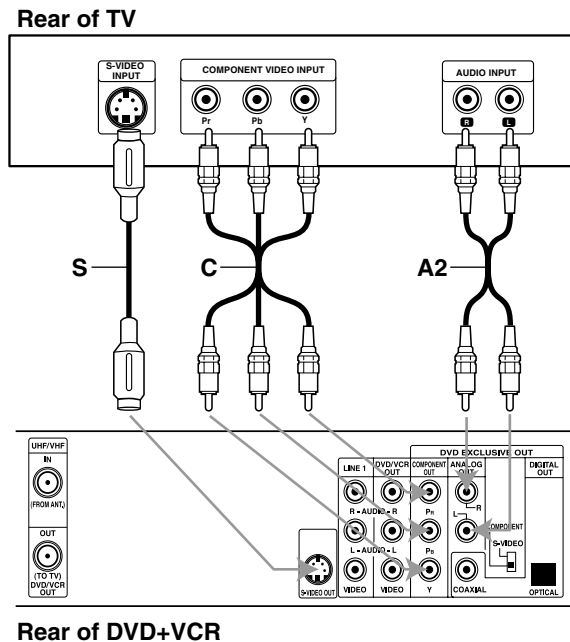

Rear of DVD+VCR

Note

If the TV has an S-video input, connect the DVD player with the S-video cable. When using an S-video cable, do not connect the yellow video cable.

Connections (Continued)

Optional, Preferred TV Connections

Note

You can ONLY listen to DVD playback using COAXIAL (X), OPTICAL (O) and AUDIO OUT (A2) connections. The tuner and VCR will still be heard through the RF.OUT (R) or DVD/VHS AUDIO OUT (A1) jack. (See page 12.)

Connecting to an amplifier equipped with two channel analog stereo or Dolby Surround

Connect the Left and Right AUDIO OUT (or DVD/VHS AUDIO OUT) jacks on the DVD+VCR to the audio left and right in jacks on your amplifier, receiver, or stereo system using the audio cables (A1, A2) supplied.

Connecting to an amplifier equipped with two channel digital stereo (PCM) or to an Audio/Video receiver equipped with a multi-channel decoder (Dolby Digital™, MPEG 2, or DTS)

- 1 Connect one of the DVD+VCR's DIGITAL AUDIO OUT jacks (OPTICAL O or COAXIAL X) to the corresponding jack on your amplifier. Use an optional digital (optical O or coaxial X) audio cable.
- 2 You will need to activate the DVD+VCR's digital output. (See *Digital Audio Output* on page 20).

Digital Multi-channel sound

A digital multi-channel connection provides the best sound quality. For this you need a multi-channel Audio/Video receiver that supports one or more of the audio formats supported by your DVD+VCR (MPEG 2, Dolby Digital and DTS). Check the receiver manual and the logos on the front of the receiver.

Caution:

Due to the DTS Licensing agreement, the digital output will be in DTS digital out when DTS audio stream is selected.

Notes

- If the audio format of the digital output does not match the capabilities of your receiver, the receiver will produce a strong, distorted sound or no sound at all.
- Six Channel Digital Surround Sound via digital connection can only be obtained if your receiver is equipped with a Digital Multi-channel decoder.
- To see the audio format of the current DVD in the on-screen display, press AUDIO.

Rear of DVD+VCR

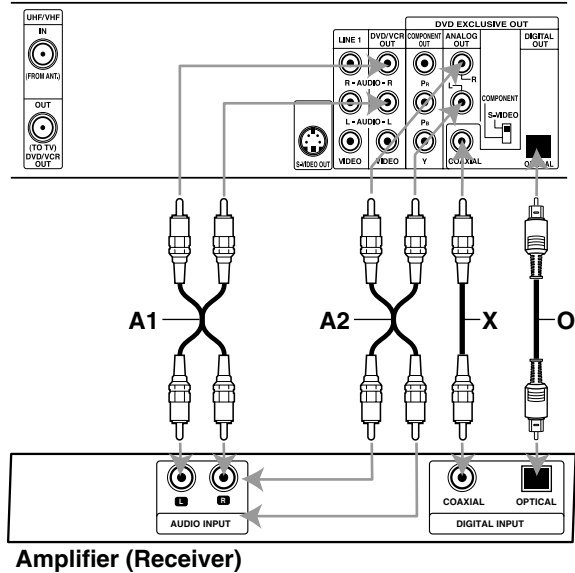

Accessory Audio/Video (A/V) Connections to DVD+VCR

Connect the VHS IN 1 or AV INPUT jacks on the DVD+VCR to the audio/video out jacks on your accessory component, using the optional audio/video cables.



Jack panel of Accessory

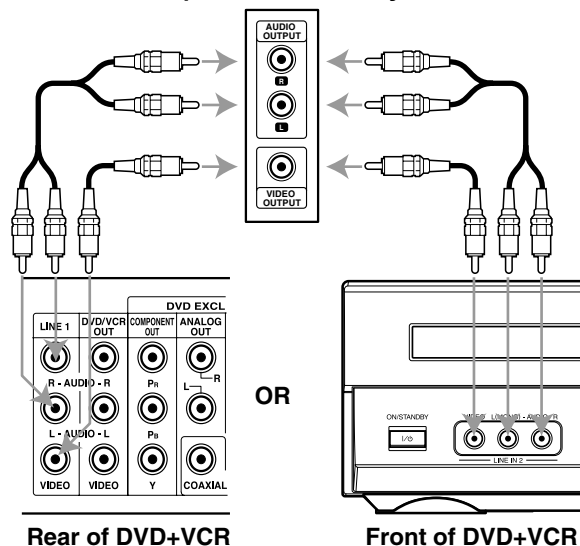

Rear of DVD+VCR

Front of DVD+VCR

Before Operation - VCR Part

On-Screen Display (OSD)

Some of these functions will be displayed every time the VCR is operated.

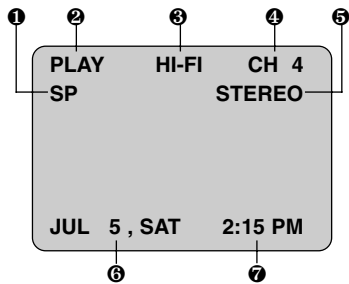

❶ TAPE SPEED DISPLAY

Shows the current tape speed.

❷ FUNCTION DISPLAY

Indicates the function in progress.

❸ HI-FI DISPLAY

Indicates when this unit is playing back tape recorded with Hi-Fi.

❹ CHANNEL DISPLAY

Indicates the selected channel (or LINE1, LINE2).

❺ STEREO/SAP DISPLAY (MONO is not displayed)

Shows the type of audio signal received by the VCR tuner.

❻ DATE DISPLAY

Shows the current date. (Month/Date/Day of the week format)

❼ CLOCK/COUNT/REMAIN DISPLAY

Shows the current time, the tape counter and remaining time on the tape.

Each press of the **ENTER** changes the TV screen in the following sequence.

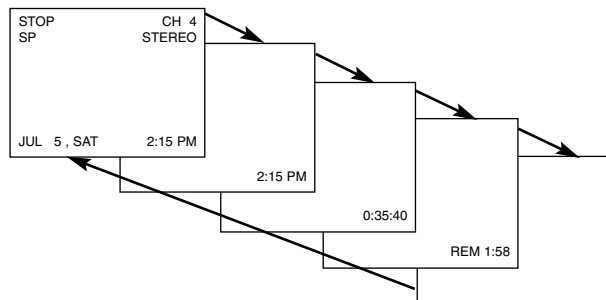

N Notes

- The function displays can be seen displayed on the TV screen for 5 seconds.
- The clock (or tape counter, tape remaining) mode will continue until you press **ENTER**.
- The tape counter and the remaining tape length indicator appear only when a cassette is inserted. Also, the remaining tape length indicator appears after any tape operation.

Easy Information

If the Extended Data Service (XDS) signals are provided along with normal TV signal in your area or during playback of a tape recorded with Extended Data Service (XDS) signals, the station ID, program title and program details are shown on the TV screen.

When viewing a channel with Extended Data Service (XDS) signals, press **ENTER** then the station ID will appear on the TV screen. Press **ENTER** again and the program details will appear on the TV screen.

When viewing a tape recorded with Extended Data Service (XDS) signals, press **ENTER** twice then the program title and program details will appear on the TV screen.

Program Details

LENGTH: Indicates the run length of a program.

TIME REMAINING: Indicates the remaining time of a program.

RATING: Indicates the rating of the current program (N/A, G, PG, PG-13, R, NC-17, X and Not Rated). The rating N/A means that the motion picture ratings are not applicable to this program.

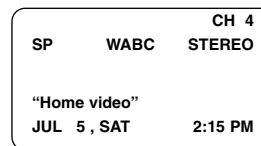

Easy Information Screen (Station ID)

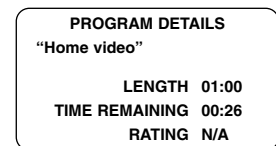

Easy Information Screen (Program details)

Setting the On-Screen Display

The **SETUP**, clock setting, and timer recordings are accessed conveniently with On-Screen Menu Displays that lead you through each step. The following pages describe the On-screen selections to be set.

Menu Selection

Your VCR allows remote control adjustment of several features.

1 Press **VCR MENU** and the **MAIN** menu will appear.

2 Select the desired menu with **▲/▼** button and then press **ENTER**.

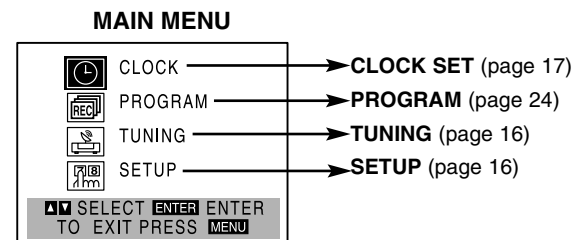

N Note

Menus remain on-screen for 3 minutes.

3 Press **VCR MENU** when finished.

Before Operation - VCR Part (Continued)

Setting the VCR Setup Menu

- 1 Press **VCR MENU** and the **MAIN** menu will appear.
- 2 Press **▲/▼** to select the **SETUP** menu, then press **ENTER**.
The **SETUP** menu will appear.

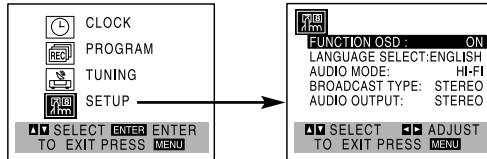

- 3 Press **▲/▼** to choose a desired option on the **SETUP** menu. Then press **◀/▶** to choose a desired setting.

FUNCTION OSD

The on-screen display of this DVD+VCR can be turned on or off.

- **FUNCTION OSD** can be switched between **ON** and **OFF** by pressing **◀/▶**.

LANGUAGE SELECT

The on-screen programming of this DVD+VCR can be displayed in either English, Spanish, or French.

- **LANGUAGE SELECT** can be switched among **ENGLISH**, **SPANISH** and **FRENCH** by pressing **◀/▶**.

AUDIO MODE

The DVD+VCR has two separate audio playback systems, the high quality VHS Hi-Fi system and standard **NORMAL** mono system. The same audio is generally recorded on both systems. The VHS Hi-Fi system plays on separate (left and right) channels, and the **NORMAL** system plays monaural sound. The normal track is always played so the cassette can be played on a DVD+VCR that does not have VHS Hi-Fi.

- **AUDIO MODE** can be switched between **HI-FI** and **NORMAL** by pressing **◀/▶**.

BROADCAST TYPE (STEREO/SAP/MONO)

Multichannel Television Sound (MTS) carries stereo and/or Second Audio Program (SAP) bilingual signals. Set this display to the desired position when both MTS stereo and SAP signals are received. When only one of the MTS signal is received, the DVD+VCR automatically selects the corresponding receiving mode (Stereo or SAP) regardless of the selected position. For normal operation, the display should be in the **STEREO** position. The DVD+VCR will then record a **STEREO** program when available, and record a **mono** program IF the program is **NOT IN STEREO**. For weak **STEREO** and/or **SAP** broadcasts, changing the display to **mono** may give clearer sound.

- **BROADCAST TYPE** can be switched among **STEREO**, **SAP**, and **MONO** by pressing **◀/▶**.

AUDIO OUTPUT (STEREO/LEFT/RIGHT)

Used during playback [when **AUDIO MODE** (**HI-FI**/**NORMAL**) is in **HI-FI** position] for selecting the audio output signals from the **AUDIO OUT** terminals (L ch and R ch), and **RF.OUT**.

This display setting should normally be left in the **stereo** position, so that when a **stereo** tape is played, the **stereo** sound will be heard through the left and right channels. If a **mono** tape is played and the audio output is set to **stereo**, the same **mono** sound will be heard from both left and right channels.

- **AUDIO OUTPUT** can be switched among **STEREO**, **LEFT**, and **RIGHT** by pressing **◀/▶**.

- 4 Press **VCR MENU** when finished.

Channel Selection

This DVD+VCR is equipped with a frequency synthesized tuner capable of receiving up to 181 channels. These include VHF channels 2-13, UHF channels 14-69 and CATV channels 1-125.

Preparation:

- Connect the DVD+VCR to the desired type of antenna or cable TV system, as shown in Connecting Antenna/Cable TV to DVD+VCR on page 11.

AUTO CHANNEL PROGRAMMING

- 1 Press **VCR MENU** and the **MAIN** menu will appear.
- 2 Press **▲/▼** to select the **TUNING** menu, then press **ENTER**.
The **TUNING** menu will appear.

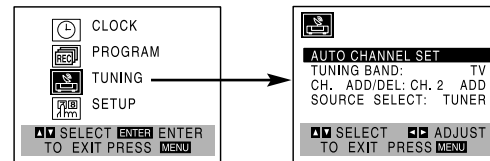

- 3 Press **▼** to choose the **SOURCE SELECT** option, then press **◀/▶** to select **TUNER**.
Press **◀/▶** repeatedly to switch among **TUNER**, **LINE1** and **LINE2**.
- 4 Press **▲/▼** to choose the **AUTO CHANNEL SET** option, then press **◀/▶** to set the channel.
The tuner will automatically cycle through all available channels in the area and place them in the tuner's memory.
- 5 After the **AUTO CHANNEL SET** **PROCEEDING** is complete, make sure the **TUNING BAND** is set appropriately (**TV** or **CATV**) by pressing **▲/▼** and choosing the correct **TUNING BAND** (**TV** or **CATV**) by pressing **◀/▶** using the **TUNING** menu.
Remember, **TV** is for the air antenna reception, **CATV** is for cable or wireless cable connection.
- 6 Press **VCR MENU** to return to the **TV** screen.
- 7 Use **CH/TRK (+/-)** or **CHANNEL (▲/▼)** on the front panel to cycle the DVD+VCR through the channels in memory.

TO ADD OR ERASE CHANNELS FROM MEMORY

This feature allows you to add or erase channels from memory manually.

- 1 Press **▼** to choose the **CH. ADD/DEL** option on the **TUNING** menu. Press **◀/▶** to select a channel to add or erase.
- 2 Press **ENTER** to add or erase the channel.
Repeat steps 1 and 2 to add or erase channels.
- 3 Press **VCR MENU** to return to the **TV** screen.

Before Operation - VCR Part (Continued)

Setting the Clock

The DVD+VCR gives you two ways to set the time and date: the Auto Clock Feature or manually. The Auto Clock Feature enables the DVD+VCR to set up the clock when the DVD+VCR is turned off.

Things to know before starting

- The clock uses the 12-hour system. (Be sure to set AM and PM correctly.)
- The initial Clock Setting is **JANUARY 1, 2003, 12:00 AM**.

Auto Clock Set

The Auto Clock Set feature is set to ON at the factory. In the ON setting, the DVD+VCR looks for a channel carrying XDS (Extended Data Services) information. XDS updates the clock using the Coordinated Universal Time.

The Auto Clock Feature enables the DVD+VCR to set up the clock when the DVD+VCR is turned off.

- 1 Press VCR MENU and the MAIN menu will appear.**
- 2 Press ▲/▼ to choose the CLOCK menu.**
- 3 Press ENTER and the CLOCK menu will appear.**

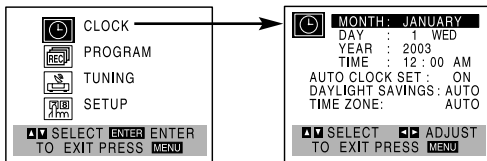

- 3 Press ▼ to choose the AUTO CLOCK SET option.**
Press ◀/▶ to choose ON.

The Auto Clock Set feature is set to ON at the factory. In the ON setting, the DVD+VCR looks for a channel carrying XDS (Extended Data Services) information. XDS updates the clock using the Coordinated Universal Time.

- 4 Press ▼ to choose the DAYLIGHT SAVINGS item.**

Press ◀/▶ to choose AUTO, ON or OFF.

If you choose AUTO, the VCR sets the clock using the DST information broadcast in the signal (channel).
If you choose ON, the VCR sets the clock when the Daylight Saving Time is started and ended.

- 5 Press ▼ to choose the TIME ZONE item.**
Press ◀/▶ to choose the correct time zone (AUTO, EASTERN, CENTRAL, MOUNTAIN, PACIFIC, ALASKA or HAWAII).

If "AUTO" is selected as the time zone, the VCR sets the clock using the first Coordinated Universal Time information it finds in a broadcast signal.

- 6 Press VCR MENU when finished.**

- 7 Turn off the DVD+VCR and the auto clock setting works.**

Note

There are cases where the TV station does not send or sends wrong date and/or time information and the DVD+VCR sets the incorrect time.

If this happens we recommend that you set the clock manually.

Manual Clock Set

Example: July 5, 2003 ; 2:15 AM

- 1 Press VCR MENU and the MAIN menu will appear.**
- 2 Press ▲/▼ to choose the CLOCK menu.**
- 3 Press ENTER and the CLOCK menu will appear.**

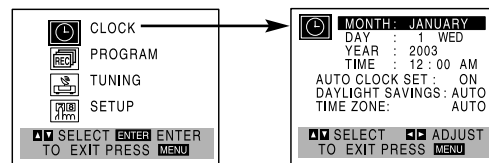

- 3 Press ◀/▶ to choose the month.**
- 4 Press ▼ to choose the DAY option.**
Use ◀/▶ to choose the day.
The day of the week will display automatically.
- 5 Press ▼ to choose the YEAR option.**
Use ◀/▶ to choose the year.
- 6 Press ▼ to choose the TIME option.**
Use ◀/▶ to choose the time.
Press and hold ◀/▶ to advance clock continuously.
- 7 Press ▼ to choose the DAYLIGHT SAVINGS item.**

Use ◀/▶ to choose AUTO, ON or OFF.

If you choose AUTO, the VCR sets the clock using the DST information broadcast in the signal (channel).

If you choose ON, the VCR sets the clock when the Daylight Saving Time is started and ended.

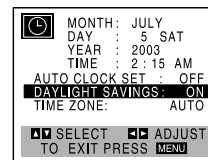

- 8 Press VCR MENU when finished.**

Note

If setting the clock manually, "AUTO CLOCK SET" must set to "OFF".

If set to "ON", an incorrect date and/or time will be entered again when the DVD+VCR is turned off.

Before Operation - DVD Part





General Explanation

This manual gives the basic instructions for operating the DVD+VCR. Some DVDs require specific operation or allow only limited operation during playback. When this occurs, the symbol  appears on the TV screen, indicating that the operation is not permitted by the DVD+VCR or is not available on the disc.









On-Screen Display

The general playback status can be displayed on the TV screen. Some options can be changed on the menu.

On-screen display operation

- 1** Press DISPLAY during playback.
- 2** Use / to select an option.
The selected option will be highlighted.
- 3** Use / to change the setting of an option.
The number buttons can also be used for setting numbers (e.g., title number). For some functions, press ENTER to execute the setting.





















Temporary Feedback Field Icons

-  TITLE Repeat Title
-  CHAPT Repeat Chapter
-  TRACK Repeat Track (non-PBC Video CDs and Audio CD only)
-  ALL Repeat Disc (non-PBC Video CDs and Audio CD only)
-  A B Repeat A-B
-  OFF Repeat Off
-  Resume play from this point
-  Action prohibited or not available

Notes













- Some discs may not provide all of the features on the on-screen display example shown below.
- If no button is pressed for 10 seconds, the on-screen display disappears.

DVD

Options		Function (Press  /  to select desired option)	Selection Method
Title Number	 1/3	Shows the current title number and total number of titles, and skips to the desired title number.	 /  , or Numeric, ENTER
Chapter Number	 1/12	Shows the current chapter number and total number of chapters, and skips to the desired chapter number.	 /  , or Numeric, ENTER
Time search	 0:16:57	Shows the elapsed playing time, and searches the point by the elapsed time directly.	Numeric, ENTER
Audio language and Digital Audio Output mode	 1 ENG D DD 5.1 CH	Shows the current audio soundtrack language, encoding method, and channel number, and changes the setting.	 /  , AUDIO
Subtitle language	 OFF	Shows the current subtitles language, and changes the setting.	 /  , SUBTITLE
Angle	 1/1	Shows the current angle number and total number of angles, and changes the angle number.	 /  , ANGLE
Sound	 NORM.	Shows the current sound mode, and changes the setting.	 / 

VCD2.0

VCD1.1

Items		Function (Press  /  to select desired item)	Selection Method
Track Number	 1/4	Displays the current track number, total number of tracks and PBC On mode, and skips to the desired track number.	 /  , or Numbers, ENTER
Time	 0:16:57	Displays the elapsed playing time (Display only)	-
Audio Channel	 STER.	Displays the audio channel, and changes you make to the audio channel.	 / 
Sound	 NORM.	Displays the current sound mode, and any changes you make to the setting.	 / 

Before Operation - DVD Part (Continued)

Initial Settings

You can set your own Personal Preferences on the DVD+VCR.

General Operation

- 1 Press **SETUP**.
The setup menu appears.



- 2 Use **▲/▼** to select the desired option.
The screen will show the current setting for the selected option, as well as alternate setting(s).
- 3 While the desired option is selected, press **▶**, then **▲/▼** to select the desired setting.
- 4 Press **ENTER** to confirm your selection.
Some options require additional steps.
- 5 Press **SETUP**, **RETURN**, or **PLAY** to exit the setup menu.

Language

Disc Language **DVD**

Select a language for the disc's Menu, Audio, and Subtitle.

Original : The original language set for the disc is selected.

Other : To select another language, press number buttons to enter the corresponding 4-digit number according to the language code list on page 42. If you enter the wrong language code, press CLEAR.

Notes

Disc Language selection may not work for some DVDs.



Menu Language

Select a language for the setup menu. This is the menu you see when you press **SETUP**.



Picture

TV Aspect **DVD**

4:3 Letterbox: Select when a standard 4:3 TV is connected. Displays theatrical images with masking bars above and below the picture.

4:3 Panscan: Select when a standard 4:3 TV is connected. Displays pictures cropped to fill your TV screen. Both sides of the picture are cut off.

16:9 Wide: Select when a 16:9 wide TV is connected.

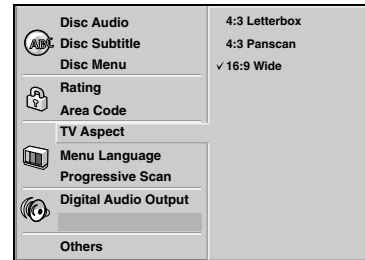

Progressive Scan **DVD**

Progressive Scan Video provides the highest resolution pictures with less flicker and line structure.

If you are using the COMPONENT VIDEO OUT jacks, but are connecting the DVD Player to a standard (analog) television, set Progressive Scan to Off.

If you are using the Component Video jacks for connection to a TV or monitor that is compatible with a progressive scan signal, set Progressive Scan to On.

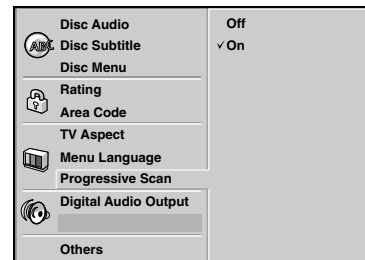

Notes

- Progressive Scan is available only when the VIDEO OUTPUT switch on the rear panel is set to COMPONENT.

Caution

Once the setting for progressive scan output is entered, an image will only be visible on a progressive scan compatible TV or monitor. If you set Progressive Scan to On in error, you must reset the unit. Pointing the remote at the player, press the STOP key to stop any disc that is playing. Next, press the STOP key again and hold it for five seconds before releasing it. The video output will be restored to the standard setting, and a picture will once again be visible on a conventional analog TV or monitor.

Before Operation - DVD Part (Continued)

Sound

Digital Audio Output

Each DVD disc has a variety of audio output options. Set the DVD+VCR's Digital Audio Output according to the type of audio system you use.

DOLBY DIGITAL/PCM: Select DOLBY DIGITAL/PCM if you connected the DVD+VCR's DIGITAL AUDIO OUT jack to a Dolby Digital decoder (or an amplifier or other equipment with a Dolby Digital decoder).

Stream/PCM: Select Stream/PCM if you connected the DVD+VCR's DIGITAL AUDIO OUT jack to an amplifier or other equipment with a DTS decoder, Dolby Digital decoder or MPEG decoder.

PCM: Select when connected to a 2 channel digital stereo amplifier. The DVD+VCR output sounds in the PCM 2ch format when you play a DVD video disc recorded with a Dolby Digital, MPEG1, or MPEG2 recording system.



Sample Frequency

To change the Sample Frequency setting, first select the desired Digital Audio Output as indicated as above. If your receiver or amplifier is NOT capable of handling 96KHz signals, select 48KHz. When this choice is made, this unit will automatically convert any 96KHz signals to 48KHz so your system can decode them. If your receiver or amplifier is capable of handling 96KHz signals, select 96KHz. When this choice is made, this unit will pass each type of signal through without any further processing.

Others

The DRC, Vocal, PBC, B.L.E., Pluge and DNR settings can be changed.

- Press ▲/▼ to select the desired item and press ENTER. The setting of the selected item alternates between On and Off.



Dynamic Range Control (DRC)

With the DVD format, you can hear a program's soundtrack in the most accurate and realistic presentation possible, thanks to digital audio technology. However, you may wish to compress the dynamic range of the audio output (the difference between the loudest sounds and the quietest ones). Then, you may listen to a movie at a lower volume without losing clarity of sound. Set DRC to On for this effect.

Vocal

Set Vocal to On only when a multi-channel karaoke DVD is playing. The karaoke channels on the disc will mix into normal stereo sound.

PBC

Set Playback Control (PBC) to On or Off.

On: Video CDs with PBC are played according to the PBC.
Off: Video CDs with PBC are played the same way as Audio CDs.

B.L.E. (Black Level Expansion)

To select the black level of playback pictures. Set your preference and monitor's ability.

On: Expanded grey scale. (0 IRE cut off)
Off: Standard grey scale. (7.5 IRE cut off)

Pluge (Blacker than Black)

For proper adjustment of your television brightness settings utilizing a commercially available test disc.

On: Select when you adjust the level of your TV using a commercially available test disc that contains pluge signals.

Off: For normal use.

DNR (Digital Noise Reduction)

You can reduce ambient noise in the picture.

DNR1: Normal level
DNR2: Expanded level.
Off: Off.

Notes

- Actual picture enhancement may vary depending on the quality of the disc.
- While the DNR2 (expanded level) can provide additional improvement in the reduction of noise in the video signal, it may produce undesirable picture artifacts on some discs. Should this occur, select a more appropriate DNR level (normal or off).
- Depending on the disc, some picture detail may be lost by the picture enhancement.
- A DVD audio disc with Dolby Digital or DTS soundtrack may be played, some DVD audio discs include moving pictures which may be modified by the above processes.

Before Operation - DVD Part (Continued)

Parental Control

Rating **DVD**

Movies on DVDs may contain scenes not suitable for children. Therefore, discs may contain Parental Control information that applies to the complete disc or to certain scenes on the disc. These scenes are rated from 1 to 8, and alternatively, more suitable scenes are available for selection on some discs. Ratings are country dependent. The Parental Control feature allows you to prevent discs from being played by your children or to have certain discs played with alternative scenes.

Disc Audio	8
Disc Subtitle	7
Disc Menu	6
Rating	5
Area Code	4
TV Aspect	3
Menu Language	2
Progressive Scan	1
Digital Audio Output	▶Unlock Change
Others	

- 1 Select Rating on the Setup menu using ▲/▼ buttons.
- 2 While Rating is selected, press ▶.
- 3 When you have not entered a password yet.
Enter a 4-digit password using the numbered buttons to create a personal 4-digit security password, then press ENTER. Enter the 4-digit password again and press ENTER to verify.
When you have already entered a password;
Enter a 4-digit password using the numerical buttons to confirm the personal 4-digit security password, then press ENTER.

If you make a mistake before pressing ENTER, press CLEAR and enter 4-digit security password again.

- 4 Select a rating from 1 to 8 using ▲/▼ buttons.
Level 1 : DVD software for adults cannot be played back.
Level 8 : All DVD software can be played back.
The limitation will be more severe as the level number is lower.
Unlock: If you select Unlock, Parental Control is not active. The disc will play in full.
Ratings 1 to 8: Some discs contain scenes not suitable for children. If you set a rating for the DVD+VCR, all disc scenes with the same rating or lower will be played. Higher rated scenes will not be played unless an alternative scene is available on the disc. The alternative must have the same rating or a lower one. If no suitable alternative is found, playback will stop. You must enter the 4-digit password or change the rating level in order to play the disc.

- 5 Press ENTER to confirm your rating selection, then press SETUP to exit the menu.

Area Code **DVD**

Enter the code of a country/area whose standards were used to rate the DVD video disc, referring to the list (See "Country/Area Code List", page 43.).

Disc Audio	Code Set
Disc Subtitle	U S
Disc Menu	
Rating	
Area Code	
TV Aspect	
Menu Language	
Progressive Scan	
Digital Audio Output	
Others	

- 1 Select Area Code using the ▲/▼ buttons on the setup menu.
- 2 While Area Code is selected, press ▶.
- 3 Follow step 3 of "Rating" on left.
- 4 Select the first character using the ▲/▼ buttons.
- 5 Press ▶ to shift to second character and select the second character using ▲/▼ buttons.
- 6 Press ENTER to confirm your Area code selection, then press SETUP to exit the menu.

N Note

Confirmation of the 4-digit password is necessary when the password is changed (see Changing the 4-digit password below).

Changing the 4-digit password

- 1 Follow Steps 1-2 as shown above to the left (Rating).
- 2 Enter the old password, then press ENTER.
- 3 Select Change using ▲/▼ buttons then press ENTER.
- 4 Enter the new 4-digit password, then press ENTER.
- 5 Enter exactly the same password a second time and verify by pressing ENTER.
- 6 Press SETUP to exit the menu.

If you forget your 4-digit password

If you forget your password, clear the current password by following the procedure below.

- 1 Press SETUP to display the setup menu. Move the cursor down to "Rating".
- 2 Use the Number buttons to enter "210499". The cursor will move up to "Disc Audio" automatically. The 4-digit password is cleared.
- 3 Enter a new password as shown above to the left (Rating).

Operation with tape

Normal Playback

Preparation:

- Turn on the TV.
- Tune the TV to the DVD+VCR output channel (CH 3 or 4) or set the TV's source selector to VIDEO.
- If a direct VIDEO/AUDIO connection is made between the DVD+VCR and the TV, set the TV's source selector to VIDEO.
- Set the Output Source to VCR as shown in Setting the Output Source on page 6.

1 Insert a prerecorded video cassette.

The  indicator will light and the DVD+VCR will power-up automatically.

- Make sure that the TIMER indicator in the display window is not lighted. If it is, press **POWER** once.
- If a tape without a safety tab is inserted, the unit will start playback automatically.

2 Press PLAY once.

PLAY appears on the TV screen .

- It is not necessary to select the tape speed for playback. It will be automatically selected by the DVD+VCR.
- In playback, the **TV/VCR** selector switches to VCR mode automatically.

3 Press STOP to stop playback.

STOP appears on the TV screen.

- If the tape reaches the end before STOP is pressed, the DVD+VCR will automatically stop, rewind, eject, and it will turn itself off.

Tracking Control

Auto Tracking

The automatic tracking function adjusts the picture to remove snow or streaks.

The AUTO TRACKING function works in the following cases:

- When the AUTO TRK button is pressed.
- A tape is played back for the first time.
- Tape speed (SP, LP, SLP) changes.
- Streaks or snow appear because of scratches on the tape.

Manual Tracking

If noise appears on the screen during playback, press either **CH/TRK (+/-)** on the remote control or **CHANNEL (▲/▼)** on the front panel until the noise on the screen is reduced.

- In case of vertical jitter, adjust these controls very carefully.
- Tracking is automatically reset to normal when the tape is ejected or the power cord is unplugged for more than 3 seconds.

Special Effect Playbacks

Special effects playback notes

- Horizontal lines (noise bars) will appear on the TV screen. This is normal.
- The audio is automatically muted during special effect modes, so there is no sound during search.
- During the high-speed picture search modes, a short period is needed to stabilize tape speed when re-entering the PLAY mode. Slight interference may be observed during this period.

Search

This function lets you quickly and visually search for a desired tape section in either direction: forward and reverse.

1 Press REW or FWD during playback.

The DVD+VCR will be activated in the SEARCH mode.

- If the DVD+VCR is left in the SEARCH mode for more than 3 minutes, the DVD+VCR will automatically enter the PLAY mode, to protect the tape and video heads.

2 To return to playback, press PLAY.

Still Picture and Frame-by-Frame Playback

1 Press PAUSE/STILL during playback.

Still picture will appear on the TV screen.

- If a still picture vibrates vertically, stabilize it by pressing **CH/TRK (+/-)** on the remote control.
- If the DVD+VCR is left in the STILL mode for more than 5 minutes, the DVD+VCR will automatically enter the STOP mode to protect the tape and video heads.

2 Press PAUSE/STILL repeatedly to advance the video picture one frame at a time while viewing a still picture.

3 To return to playback, press PLAY.

Slow Motion

1 Press SLOW during playback or still mode.

The tape will be played back at a speed 1/19 times slower than the normal speed.

- During slow playback, use **CH/TRK (+/-)** on the Remote Control to minimize noise bands.
- If slow motion mode continues for more than 3 minutes, the DVD+VCR will automatically change to playback mode.

2 To return to playback, press PLAY.

Instant Skip

This is useful for skipping commercials or short program segments.

1 Press INSTANT SKIP during the playback mode.

The tape will fast forward picture search through 30 seconds of recording.

- The skipping time can be extended by pressing INSTANT SKIP.
- Subsequent presses result in advancing the fast forward picture search time by 30-second increments (maximum 3 minutes).

2 When the search is completed, the DVD+VCR will go into playback mode automatically.

Operation with tape (Continued)

VISS (VHS Index Search System)

The VHS INDEX SEARCH SYSTEM enables you to locate the beginning of any recording made on this VCR. Whenever a recording begins, an invisible INDEX mark is recorded on the tape.

VISS Scan

VISS SCAN lets you search out each VISS mark on the recorded tape and play 5 seconds before advancing to the next VISS mark.

- 1 Insert a cassette tape that has VISS signals marked.**
- 2 Press the VISS button once during PLAYBACK or STOP mode.**

The VISS -- indicator will appear in the display window.
- 3 Press either the FWD or the REW button.**

The VISS SCAN will start. The indicator appears simultaneously during scanning. The tape will be rewound or rapidly advanced to the next signal marked.

The tape will be played back for approximately 5 seconds, and then rewound or rapidly advanced to the next VISS signal.

 - Press VISS or STOP button to stop the VISS SCAN mode.
- 4 At the desired program, press the PLAY button.**

Normal playback of that program will begin.

VISS Search

You can locate the desired program and play it back automatically by designating the number of its VISS signal. Up to the 99th VISS signal from the preset position on the tape can be located.

- 1 Press the VISS button once during PLAYBACK or STOP mode.**

The VISS -- indicator will appear in the display window.
- 2 Enter the number of VISS signals you wish to skip.**

Up to 99 signals may be skipped from any given position on the tape.
- 3 Press either the FWD or REW button once.**

The SrCH 02 (for example) message appears in the display window. When the desired VISS signal is found, playback begins automatically.

 - If the end of the tape is reached during forward VISS search, the VCR will automatically stop, rewind, eject, and turn itself off.

Normal Recording

Preparation:

- Turn on the power of both the DVD+VCR and TV.
- Tune the TV to the DVD+VCR output channel (CH 3 or 4) or set the TV's source selector to VIDEO.
- If a direct VIDEO/AUDIO connection is made between the DVD+VCR and the TV, set the TV's source selector to VIDEO.

- 1 Insert a video cassette that the safety tab intact.**
- 2 Select the desired channel by using CH/TRK (+/-).**
 - If you are recording from another source via audio/video input jacks (at the Rear or Front panel), select the LINE1 or LINE2 by pressing INPUT SELECT.
- 3 Set the desired recording speed (SP or SLP) by pressing SP/SLP.**
 - This DVD+VCR is not designed to record in LP mode.
- 4 Set the MTS mode as desired (See page 17, 27).**
- 5 Press REC/OTR once.**

Recording will start. (The REC indicator will light in the display window.)

 - REC indicator appears only when the Output Source is set to VCR.
 - If a cassette with no safety tab is loaded, the cassette will be ejected automatically.
- 6 Press STOP to stop recording.**

If the tape reaches the end before STOP is pressed, the DVD+VCR will automatically stop, rewind, eject, and it will turn itself off.

To pause the recording

- 1 Press PAUSE/STILL to pause the tape during recording.

The REC indicator will flash in the display window.
- 2 When you want to continue recording, press PAUSE/STILL or press REC/OTR.
 - After 5 minutes in pause mode, the tape will be stopped automatically to protect the tape and the video heads.

To record one TV program while watching another

- 1 Press TV/VCR to select the TV mode during recording.

The VCR indicator disappears.
- 2 Using the TV, select the channel to be viewed.

Tips

Always use PAUSE/STILL for best results when making changes during recording.

For example: To change channels during recording, first press PAUSE/STILL to put the unit in pause mode. Then select the desired channel on the DVD+VCR, and press PAUSE/STILL again to resume recording.

Operation with tape (Continued)

Timer Recording

This DVD+VCR can be programmed to record up to 8 programs within a period of 1 year. For unattended recording, the timer needs to know the channels to be recorded and the starting and ending times.

Things to know before starting

- If you try to set the program timer before setting the clock, PLEASE SET THE CLOCK appears for a moment and then CLOCK menu appears on the TV screen. Set the time and date before proceeding.
- Make sure a tape is in the DVD+VCR and the safety tab is in place or the tape will be automatically ejected.

Preparation:

- Turn on the power of both the DVD+VCR and the TV.
- Be sure the TV is set to the DVD+VCR output channel (3 or 4).
- Make sure the TUNING BAND in the TUNING menu is set appropriately (TV or CATV).

1 Press VCR MENU and the MAIN menu will appear.

2 Use ▲/▼ to choose the PROGRAM menu.

3 Press ENTER to go to the PROGRAM menu. The PROGRAM menu will appear.

- If all programs have already been entered, FULLY PROGRAMMED message will appear for a moment and then PROGRAM 1 will appear on the TV screen.

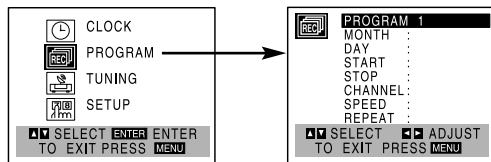

4 Use ◀/▶ to choose the PROGRAM No. (1-8).

5 Use ▼ to choose the MONTH option.

Use ◀/▶ to choose the desired month.

6 Use ▼ to choose the DAY option.

Use ◀/▶ to choose the desired day.

7 Use ▼ to choose the START option.

Use ◀/▶ to choose the desired start time.
Press and hold ◀/▶ to advance the clock faster.

8 Use ▼ to choose the STOP option.

Use ◀/▶ to choose the desired stop time.
Press and hold ◀/▶ to advance the clock faster.

9 Use ▼ to choose the CHANNEL option.

Use ◀/▶ to choose the desired channel (Channel, LINE1 or LINE2).

Cable Users: If you have CABLE TV and used Cable Box in Connecting Antenna/Cable TV to DVD+VCR (page 11), using a cable box converter, you must set the channel in this step to match the cable box output channel (usually CH 3 or 4). Change channels on the cable box instead of with the DVD+VCR.

10 Use ▼ to choose the SPEED option.
Use ◀/▶ to choose the desired recording speed (AUTO, SP or SLP).

- AUTO mode determines how much tape is left and switches speed from SP to SLP, if necessary, to complete recording the program. There will be some picture and sound distortion at the point of the speed change.

11 Use ▼ to choose the REPEAT option.
Use ◀/▶ to choose the desired repeat (ONCE, WEEKLY or DAILY).

- ONCE event....for recording up to 8 programs on a single day or over the days within a period of 1 year.
- WEEKLY event....for recording up to 8 programs on a certain day of every week.
- DAILY event....for recording up to 8 programs at the same time(s) Monday through Friday.

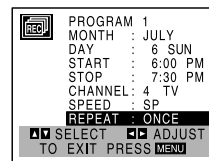

Tip

If the input data is wrong, use ▲ to select the data and correct it using ◀/▶.

12 Press VCR MENU, the program will be memorized at the DVD+VCR.

- TIMER indicator lights in the display window.
- If the program preset time is past, the PAST TIME PROGRAMMED message will appear on the TV screen. Return to the incorrect program and program it with the correct time.
- If you had entered a past date, the timer recording will be performed on that date of the next year.
- Additional programs may be entered by repeating steps 1-12.

Cable Users: If your cable hookup is via a TV converter box, you can program multiple recordings only on the converter box output channel. This is because the converter determines what channel you view through your DVD+VCR.

Tip

If you have finished programming and you want to set the DVD+VCR to record the programs you have entered. **MAKE SURE YOU HAVE INSERTED A TAPE INTO THE DVD+VCR.** The DVD+VCR is now set to record the preset programs.

Note

If the power fails or the DVD+VCR is unplugged from the AC outlet, the correct clock time and timer settings are kept in memory for approximately 3 seconds. After 3 seconds, the clock and program timer must be reset when power is restored. Reset the clock according to instructions.

After setting a timer recording, it will start if a timer recording passes over the start time when stopping the playback or recording.

Operation with tape (Continued)

Checking (Erasing) the Timer Program

Programming can be checked whenever the DVD+VCR is turned on.

- 1 Press VCR MENU and the MAIN menu will appear.
- 2 Use ▲/▼ to choose the PROGRAM menu. Press ENTER and the PROGRAM menu will appear.

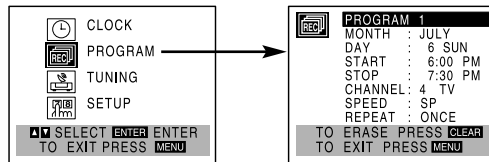

- 3 Use ◀/▶ to select a program you want to check or erase. If you want to erase the program, press CLEAR.
- 4 Press VCR MENU to return to the TV screen.

Program Priority

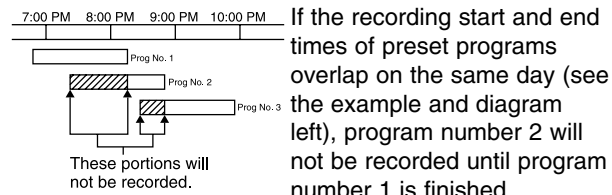

If the recording start and end times of preset programs overlap on the same day (see the example and diagram left), program number 2 will not be recorded until program number 1 is finished.

The first part of program number 2 will not be recorded. The same thing will happen to program number 3.

One touch Timer Recording(OTR)

One touch Timer Recording allows you to make a recording easily of a preset length without using the program timer.

Preparation:

- Turn on the power of both the DVD+VCR and the TV.
- Be sure the TV is tuned to the DVD+VCR output channel (3 or 4).
- If a direct VIDEO/AUDIO connection is made between the DVD+VCR and the TV, set the TV's source selector to VIDEO.

1 Insert a video cassette with the safety tab intact.

2 Select the desired channel by using CH/TRK (+/-) or number (0-9).

The channel number appears on the TV screen.

- If you are recording from another source via audio/video input jacks (at the Rear or Front panel), select the LINE1 or LINE2.

3 Set the desired recording speed (SP or SLP) by pressing SP/SLP.

The tape speed will appear on the TV screen.

4 Press REC/OTR twice.

The menu as illustrated, will appear on the TV screen.

- Recording will start. (The TIMER indicator will light)

5 Press REC/OTR repeatedly to select the recording time length.

At the end of the recording, the DVD+VCR will stop recording and shut off.

- During One touch Timer Recording, changing the channel on the DVD+VCR will not be possible.
- You can stop the recording by pressing STOP.

ONE TOUCH TIMER RECORD MENU

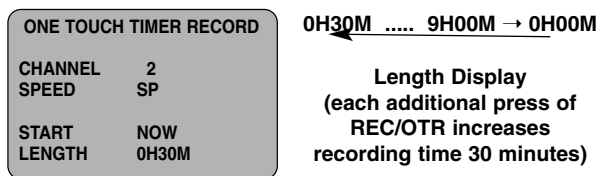

Checking the Recording Time

Press REC/OTR once to check the recording time. The recalled setting will automatically return to the TV screen after 6 seconds.

To extend the Recording Time

The recording time can be extended anytime by pressing REC/OTR.

Subsequent presses result in advancing the recording time by 30-minute increments to a maximum of 9 hours.

Notes

- If you press PAUSE/STILL during One touch timer recording, the DVD+VCR will enter the recording pause mode. Instant timer recording is cancelled.
- If the DVD+VCR is set to "0H00M", the DVD+VCR goes to normal recording mode.

Operation with tape (Continued)

Dubbing and Editing

If you wish to edit or dub your camcorder (or another VCR) recordings to this DVD+VCR, the rear (or Front) panel mounted Audio and Video (A/V) input jacks make the connections quick and easy. These direct A/V jacks will also provide better picture results than using the RF jack on the rear panel.

1 Connect the camcorder's (or another VCR's) A/V outputs to your DVD+VCR as illustrated on page 14.

2 Set the input channel "LINE2". (press INPUT SELECT to select LINE2.)

- If you have connected your DVD+VCR to the A/V input jacks on the rear of DVD+VCR, you should select the input channel LINE1 by pressing **INPUT SELECT** twice.

3 Play the tape in the camcorder (or another VCR). If you have a TV attached to your DVD+VCR, you can see the video playing.

4 When your desire recording begins, press DVD+VCR's REC/OTR once to start.

Note

Before recording, please confirm the recording start position.

Copying from DVD to VCR

This unit allows you to copy the contents of a DVD to a VHS tape.

Note

If the DVD you are attempting to copy is copy protected, you will not be able to copy the disc. It is not permitted to copy Macrovision encoded DVDs. "Lock" is displayed in the display window.

1 Insert Disc

Insert the disc you wish to copy in the DVD deck and close the disc tray.

2 Insert VHS Tape

Insert a blank VHS video tape into the VCR deck.

3 Press PLAY on the DVD deck.

The DVD will go into play mode

- If the DVD disc menu appears, you may need to press the **PLAY** manually to begin copying.

4 Press REC on the VCR deck.

- The DVD+VCR will go into Record mode.
- "CDREC" indicator will light.

5 Stop the Copy Process

When the DVD is finished playing, press the **VCR** on the remote control and then press **STOP** (■) to end the copy. You must stop the Copy process manually when the DVD movie ends, or the unit may replay and record over and over again.

Note

When you stop the DVD playback during copying, the recording on VCR is stopped automatically.

Operation with tape (Continued)

VHS Hi-Fi Stereo System/ MTS Broadcast

This DVD+VCR is equipped with the VHS Hi-Fi audio sound system for recording and playback. The information below gives a brief description of Hi-Fi audio and how to record and play a tape in the Hi-Fi audio mode.

Playback with Hi-Fi Stereo Audio Sound

A stereo TV with AUDIO/VIDEO input jacks or a stereo audio system is required for true stereo playback. To experience the full and rich stereo sound available with Hi-Fi recorded tapes, we recommend the connection of this unit to a home stereo audio system.

- 1 Set the **AUDIO MODE** option to **HI-FI** on the **SETUP** menu .

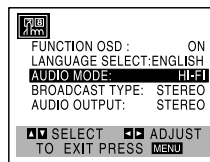

- 2 Set the **AUDIO OUTPUT** option to **STEREO** position.

(STEREO) POSITION: The left channel sound (L) is heard from the left speaker and the right channel sound (R) is heard from the right speaker.

(LEFT) POSITION: The left channel sound (L) is heard from both speakers.

(RIGHT) POSITION: The right channel sound (R) is heard from both speakers.

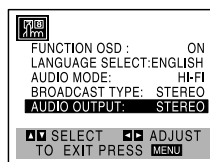

- 3 Press **VCR MENU**.

- 4 Insert a cassette and press **PLAY**.
Adjust volume at your stereo system.

MTS (Multi-Channel TV Sound)

This DVD+VCR will decode MTS stereo and bilingual (SAP) off-the-air broadcast sound signals. It also decodes stereo TV sound from local cable companies, as long as they operate on assigned cable frequencies and use the EIA-recommended MTS stereo/bilingual TV sound system.

Multichannel TV Sound Indicator (MTS)

Shows Onscreen as illustrated below when **ENTER** is pressed.

- One or both of the indicators will light, depending on the MTS broadcast.

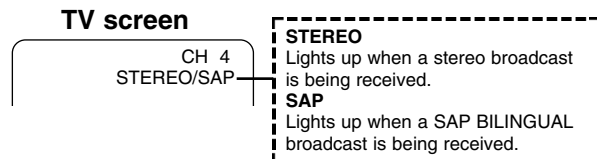

If only **STEREO** appears on the TV screen.

The DVD+VCR can record in stereo onto the VHS Hi-Fi audio tracks when the **BROADCAST TYPE** option is in the **STEREO** position. The DVD+VCR will also record mono audio onto the mono audio track.

If only **SAP** appears on the TV screen.

Set the **BROADCAST TYPE** option to **SAP**.

If **STEREO/SAP** appears on the TV screen

Use the **BROADCAST TYPE** option to select the desired recording mode (**STEREO** or **SAP**).

SAP (Second Audio Program) Recording

Some stations transmit a Second Audio Program, which is used for a second language or additional information. When the station broadcasts a Second Audio Program, follow the procedure below to record the SAP.

- 1 Insert a video cassette with the safety tab intact.
- 2 Set the **BROADCAST TYPE** option to **SAP** (**SETUP** menu).

Do this if only the **SAP** appears on the TV screen or you know the program will use the **SAP**.

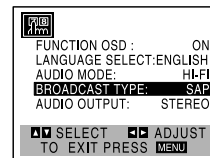

- 3 Press **VCR MENU**.

- 4 Set the desired recording speed (**SP** or **SLP**) by pressing **SP/SLP**.

- 5 Select the desired channel. The **SAP** should appear on the TV screen.

- 6 Press **REC/OTR** once

You are now recording the program you see and hear on the TV.

- 7 Press **STOP** to stop recording.

Operation with tape (Continued)

Tape Counter Memory Feature

Real-Time Counter

Shows length of tape run in hours, minutes, and seconds. Press **CLK/CNT** to select the real-time counter display.

Every press of **CLK/CNT** changes the TV screen as illustrated below.

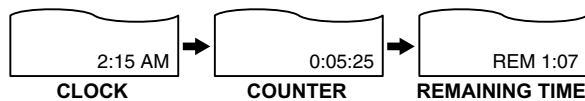

- Counter changes to "0:00:00" when the cassette is ejected.
- The real-time counter does not operate if nothing is recorded on the tape.
- The real-time counter will not work unless a tape is inserted.

Counter Memory Function

This is useful if there is a section of tape you want to view immediately after recording or if you want to return to the same point several times.

- 1** Begin recording or playing a tape.
- 2** Press **CLK/CNT** repeatedly to display the real-time counter appears on the TV screen.
- 3** At the point that you want locate later, reset the real-time counter to "0:00:00" by pressing **COUNTER RESET**.
- 4** Continue to play or record.
- 5** Press **STOP** when recording or playback finishes.
- 6** Press **REW**.
The tape automatically stops when the tape counter returns to about "0:00:00".

Tape Remaining

This function allows the time of the remaining tape to be displayed during recording or playback. Press **CLK/CNT** until the **REM** indicator displays on the TV screen during recording or playback.

Note

The remaining tape length indicator may not be displayed correctly depending on the condition of the tape and the kind of the tape (T-140, T-160, or T-210 etc)

Additional Information

- In manual recording, Timer recording, One-touch Timer Recording, playback, or fast forward modes, the DVD+VCR automatically starts rewinding the tape at the end of the tape. The cassette will stop at the beginning of the tape and be ejected, and the DVD+VCR will turn itself off.
- After you have finished using the DVD+VCR, rewind, eject, and remove the cassette. Place the cassette in its protective sleeve to protect it from dust. It is not necessary to rewind the cassette before removing it, but if you do, it will be ready to play or record the next time you use it.
- Be sure the DVD+VCR Channel Selector is on the correct channel you wish to record. The channel that is being recorded can always be checked by setting the television on the DVD+VCR channel (3 or 4) and pressing the **TV/VCR** selector to turn the DVD+VCR's VCR indicator on.
- Do not attempt to hook up more than one television set to the DVD+VCR for either recording or playback.

S-VHS Quasi Playback (SQPB)

- This DVD+VCR can also play back a tape which is recorded in S-VHS playback picture.
- This DVD+VCR cannot record in S-VHS format
- SQPB is an abbreviation for S-VHS Quasi Playback.

Auto Play System

This DVD+VCR features automatic playback. Load a cassette (with the safety tab removed).

- The Output Source is changed to VCR mode automatically.
- The power turns on automatically and playback begins.
- At the end of the tape, the DVD+VCR stops, then rewinds.
- The cassette is ejected after rewinding and goto standby.



Video Head Cleaning

- Whenever a video cassette is inserted into or ejected from this unit the video head is automatically cleaned.
- However, it is possible that the heads may become clogged when playing an old or damaged tape. If the image on your screen resembles the picture on the left while playing back a tape, the heads may require cleaning.
- To clean the heads, obtain a head cleaning tape from your local video dealer. Follows the instructions that come with the cleaning tape, as excessive use can shorten head life.

Blank Search

The Blank Search enables you to locate the end of any recording. Whenever a recording creates, a blank content is recorded on the tape.

Press **BLANK SEARCH** during playback or in the stop mode and rapidly advanced to find blank content. To find next blank content, press **BLANK SEARCH** again.

Operation with DVD and Video CD

Playing DVD and Video CD

Playback Setup **DVD** **VCD2.0** **VCD1.1**

- Turn on the TV and select the video input source connected to the DVD+VCR.
- Audio system: Turn on the audio system and select the input source connected to the DVD+VCR.
- Set the Output Source to DVD as shown in Setting the Output Source on page 6.

1 Press **OPEN/CLOSE** to open the disc tray.

2 Load your chosen disc in the tray, with the label facing up.

When a double-sided DVD is inserted, make sure the side you want to play is facing down.

3 Press **OPEN/CLOSE** to close the tray.

“dISC LOAD” appears in the display window, and playback starts automatically.

If playback does not start, press **PLAY**.

In some cases, the disc menu might appear instead.

For some VCD discs, it might take 5 or 6 secs after pressing **PLAY** before the playback picture appears.

If a menu screen is displayed

The menu screen may be displayed first after loading a DVD or Video CD that contains a menu.

DVD

Use **◀/▶/▲/▼** buttons to select the title/chapter you want to view, then press **ENTER** to start playback. Press **TOP MENU** or **MENU** to return to the menu screen.

VCD2.0

- Use the number buttons to select the track you want to view.
Press **RETURN** to return to the disc menu screen.
- Menu setting and the exact operating procedures for using the disc menu may differ depending on the disc. Follow the instructions on each menu screen.
You also may set **PBC** to **Off** under setup. See page 20.

Notes

- If Parental Control is set and the disc is not within the Rating settings (not authorized), the 4-digit password must be entered and/or the disc must be authorized (see Parental Control, on page 21).
- DVDs may have a region code.
- Your DVD+VCR will not play discs that have a region code different from your DVD+VCR. The region code for this DVD+VCR is 1 (one).
- Do not keep an image or on-screen displayed for a long time.

General Features

Note

Unless stated otherwise, all operations described use the remote control. Some features may also be available on the Setup menu.

Moving to another TITLE **DVD** 1/3

When a disc has more than one title, you can move to another title as follows:

- Press **DISPLAY** when playback is stopped, then press the appropriate numbered button (0-9) then press **ENTER** to select a title number.

Moving to another CHAPTER/TRACK

DVD **VCD1.1**  1/12  1/3

When a title on a disc has more than one chapter or a disc has more than one track, you can move to another chapter/track as follows:

- Press **SKIP** (**⏮**) or **SKIP** (**⏭**) briefly during playback to return to the beginning of the current chapter/track or to select the next chapter/track.
- Press **SKIP** (**⏮**) twice in quick succession to step back to the previous chapter/track.
- To go directly to any chapter/track during playback, press **DISPLAY**. Then, press **▲/▼** to select **C** (chapter) (or for a Video CD, select **T** for track). Then, enter the chapter number using the numbered buttons (0-9).
- For two-digit numbers, press the buttons in rapid succession.

Slow Motion **DVD** **VCD2.0** **VCD1.1**

- 1 Press **PAUSE/STEP** during playback.
The DVD+VCR will now go into **PAUSE** mode.
- 2 Press **SKIP** (**⏮**) or **SKIP** (**⏭**) during pause mode.
The DVD+VCR will enter **SLOW** mode.
- 3 Use **SKIP** (**⏮**) or **SKIP** (**⏭**) to select the required speed: **◀** 1/16, **◀** 1/8, **◀** 1/4 or **◀** 1/2 (backward), or **▶** 1/16, **▶** 1/8, **▶** 1/4 or **▶** 1/2 (forward).
- 4 To return to playback, press **PLAY**.

Note

Slow motion playback in reverse is not available from a Video CD.

Operation with DVD and Video CD (Continued)

General Features (continued)

Still Picture and Frame-by-frame playback

DVD **VCD2.0** **VCD1.1**

- 1 Press PAUSE/STEP during playback.
The DVD+VCR will now go into PAUSE mode.
- 2 With a DVD, you can advance the picture frame by frame by pressing PAUSE/STEP repeatedly on the remote control.
- 3 To return to playback, press PLAY.

Search **DVD** **VCD2.0** **VCD1.1**

- 1 Press REW or FWD for about two seconds during playback.
The DVD+VCR will now go into SEARCH mode.
- 2 Press REW or FWD repeatedly to select the required speed: ◀◀X2, ◀◀X4, ◀◀X16, ◀◀X100 (backward) or ▶▶X2, ▶▶X4, ▶▶X16, ▶▶X100 (forward).
With a Video CD, the Search speed changes: ◀◀X2, ◀◀X4, ◀◀X8 (backward) or ▶▶X2, ▶▶X4, ▶▶X8 (forward).
- 3 To return to playback, press PLAY.

Random **Karaoke DVD** **VCD1.1**

- 1 Press RANDOM during playback or in stop mode.
The unit automatically begins Random Playback and "RANDOM" appears on the TV screen.
- 2 To return to normal playback, press RANDOM until "NORMAL" appears on the TV screen.



Tips

By pressing SKIP (◀◀) or SKIP (▶▶) during Random playback, the unit selects another title (track) and resumes Random playback.



Note

This function only works with DVD Karaoke discs and video CD without PBC.

Time Search **DVD** 0:16:57

The Time Search function allows you to start playing at any chosen time on the disc.

- 1 Press DISPLAY during playback. The on-screen display appears on the screen.
The Time Search box shows the elapsed playing time of the current disc.
- 2 Within 10 seconds, use ▲/▼ to select the Time Search icon in the on-screen display.
The ":-:-:-" appears in the Time Search box.
- 3 Within 10 seconds, use the numbered buttons to enter the required start time. Enter hours, minutes and seconds from left to right in the box.
If you enter the wrong numbers, press CLEAR to remove the numbers you entered. Then enter the correct numbers.
- 4 Within 10 seconds, press ENTER.
Playback starts from the selected time on the disc. If you enter an invalid time, playback will continue from the current point.

Selecting the sound enhancement

DVD **VCD2.0** **VCD1.1**  **NORM.**  **3D SUR**  **DIALOGUE**

- 1 Press DISPLAY during playback.
- 2 Use ▲/▼ to select the sound icon.
The sound option will be highlighted.
- 3 Use ◀/▶ to select "NORM", "3D SUR" or "DIALOGUE".

NORM. : Normal sound

3D SUR: This player can produce a 3D Surround effect, which simulates multi-channel audio playback from two conventional stereo speakers, instead of the five or more speakers normally required to listen to multi-channel audio from a home theater system.

DIALOGUE: Enhances critical center channel information to make dialogue more intelligible (only when playing a DVD video disc recorded on the Dolby Digital recording system).

- To use this enhancement on audio output from the DIGITAL AUDIO OUT jack, be sure to set "Digital Audio Output" to "PCM". See page 20.

Operation with DVD and Video CD (Continued)

Repeat **DVD** **VCD2.0** **VCD1.1**



DVD Video Discs - Repeat Chapter/Title/Off

- 1 To repeat the currently playing chapter, press REPEAT.
The Repeat Chapter icon appears on the TV screen.
- 2 To repeat the title currently playing, press REPEAT a second time.
The Repeat Title icon appears on the TV screen.
- 3 To exit Repeat mode, press REPEAT a third time.
The Repeat Off icon appears on the TV screen.

Video CDs - Repeat Track/All/Off

- 1 To repeat the track currently playing, press REPEAT.
The Repeat Track icon appears on the TV screen.
- 2 To repeat the disc currently playing, press REPEAT two times.
The Repeat All icon appears on the TV screen.
- 3 To cancel Repeat mode, press REPEAT repeatedly until the Repeat Off icon appears on the TV screen.

Note

- On a Video CD with PBC, you must set PBC to Off on the setup menu to use the Repeat function.
See page 20.
- If you press SKIP (⏮) twice or SKIP (⏭) during Repeat Chapter/Track playback, the repeat playback cancels.

Repeat A-B **DVD** **VCD2.0** **VCD1.1**



To repeat a sequence in a title:

- 1 Press A-B at your chosen starting point.
A- appears briefly on the TV screen.
- 2 Press A-B again at your chosen end point.
A-B appears briefly on the TV screen, and the repeat sequence begins
- 3 To cancel the sequence, press A-B.

Zoom **DVD** **VCD2.0** **VCD1.1**

The Zoom function allows you to enlarge the video image and to move through the enlarged image.

- 1 Press ZOOM during playback or still playback to activate the Zoom function.
If you press ZOOM repeatedly, the magnification level increases up to six steps.
- 2 Use ◀/▶/▲/▼ buttons to move through the zoomed picture.
- 3 Press CLEAR to resume normal playback or return to the paused image.

Note

- The zoom function may not work for some DVDs.
- The zoom function may not work on multi-angle scenes.

Marker Search **DVD** **VCD2.0** **VCD1.1**



You can start playback from a memorized point. Up to nine points can be memorized.

To enter a mark, follow these steps.

- 1 During disc playback, press MARKER when playback reaches the spot that you want to memorize.
The Marker icon will appear on the TV screen briefly.
- 2 Repeat step 1 to enter up to nine Marker points on a disc.

To Recall a Marked Scene

- 1 During disc playback, press SEARCH.
The Marker Search menu will appear on the screen.
- 2 Within 10 seconds, press ◀/▶ to select a Marker number that you want to recall.
- 3 Press ENTER.
Playback will start from the Marked scene.
- 4 To remove the MARKER SEARCH menu, press SEARCH.

To clear a Marked Scene

- 1 During disc playback, press SEARCH.
The Marker Search menu will appear on the screen.
- 2 Within 10 seconds, press ◀/▶ to select a Marker number that you want to erase.
- 3 Press CLEAR.
The Marker number will be erased from the list.
- 4 Repeat steps 2 and 3 to erase additional Marker numbers.
- 5 To remove the MARKER SEARCH menu, press SEARCH.

Operation with DVD and Video CD (Continued)

Special DVD Features

Checking the contents of DVD Video discs: Menus

DVDs may contain menus that allow you to access special features. To use the disc menu, press MENU. Then, press the appropriate number button to select an option. Or, use ◀/▶/▲/▼ buttons to highlight your selection, then press ENTER.

Title Menu

1 Press TOP MENU.

If the current title has a menu, the menu will appear on the screen. Otherwise, the disc menu may appear.

2 The menu can list camera angles, spoken language and subtitle options, and chapters for the title.

3 To remove the title menu, press TOP MENU again.

Disc Menu

1 Press MENU.

The disc menu is displayed.

2 To remove the disc menu, press MENU again.

Camera Angle 1/1

If the disc contains sequences recorded from different camera angles, the angle icon blinks on the TV screen. You can then change the camera angle if you wish.

- Press ANGLE repeatedly during playback to select a desired angle.

The number of the current angle appears on the display.

Changing the Audio Language



Press AUDIO repeatedly during playback to hear a different audio language or audio track.

Changing the Audio Channel

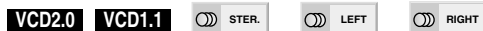

Press AUDIO repeatedly during playback to hear a different audio channel (STEREO, LEFT or RIGHT).

Subtitles 1 ENG

Press SUBTITLE repeatedly during playback to see the different subtitle languages.

Note

If  appears, the feature is not available on the disc.

Operation with Audio CD

Playing an Audio CD

- 1 **Insert a disc and close the tray.**
The menu appears on the TV screen.

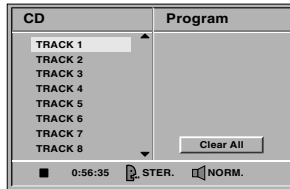

Audio CD menu

- 2 **Press ▲/▼ to select a track then press PLAY.**
Playback starts.
During playback, the current track's elapsed playing time will appear on the display window.
Playback will stop at the end of the disc.
- 3 **To stop playback at any other time, press STOP.**

Pause **CD**

- 1 Press PAUSE/STEP during playback.
- 2 To return to playback, press PLAY or press PAUSE/STEP again.

Moving to another Track **CD**

- Press SKIP (▶▶) or SKIP (◀◀) briefly during playback to go to the next track or to return to the beginning of the current track.
- Press SKIP (◀◀) twice in quick successions to step back to the previous track.
- To go directly to any track, enter the track number using the numbered buttons (0-9) during playback.

Repeat Track/All/Off **CD**

- 1 To repeat the track currently playing, press REPEAT.
The Repeat Track icon appears on the menu screen.
- 2 To repeat all tracks on a disc, press REPEAT a second time.
The Repeat All icon appears on the menu screen.
- 3 To cancel Repeat mode, press REPEAT a third time.
The Repeat Off icon appears on the menu screen.

Note

The REPEAT button is not available when the  mark appears.

Press PROGRAM to disappear the  mark.

Search **CD**

- 1 Press and hold REW or FWD for about two seconds during playback.
The player will now go into SEARCH mode.
- 2 Press REW or FWD repeatedly to select the required speed: ◀◀X2, ◀◀X4, ◀◀X8 (backward) or ▶▶X2, ▶▶X4, ▶▶X8 (forward).
- 3 Search speed and direction are indicated on the menu screen.
- 4 To exit SEARCH mode, press PLAY.

Random **CD**

- 1 Press RANDOM during playback or when playback is stopped.
The unit automatically begins Random Playback and "RAND." appears on the menu screen.
- 2 To return to normal playback, press RANDOM repeatedly until "RAND." disappears on the menu screen.

Repeat A-B **CD**

To repeat a sequence.

- 1 During disc playback, press A-B at your chosen starting point.
The Repeat icon and "A -" appears on the menu screen.
- 2 Press A-B again at your chosen end point.
The Repeat icon and "A B" appears on the menu screen, and the sequence begins to play repeatedly.
- 3 To exit the sequence and return to normal play, press A-B again.
The Repeat icon and "OFF" appear on the menu screen.

Selecting the sound enhancement **CD**

- 1 Press DISPLAY during playback.
- 2 Use ◀/▶ to select the sound icon.
The sound option will be highlighted.
- 3 Use ▲/▼ to select "NORM." or "3D SUR".

NORM. : Normal sound

3D SUR: This player can produce a 3D Surround effect, which simulates multi-channel audio playback from two conventional stereo speakers, instead of the five or more speakers normally required to listen to multi-channel audio from a home theater system.

Changing the Audio Channel **CD**

Press AUDIO repeatedly during playback to hear a different audio channel (STER., LEFT, or RIGHT).

Operation with MP3 Disc

Playing an MP3 disc **MP3**

The DVD Player can play MP3 formatted recordings on CD-ROM, CD-R or CD-RW discs.

Before playing MP3 recordings, read the notes on MP3 Recordings on right.

1 Insert a disc and close the tray.

The MP3/JPEG/WMA choice menu appears on the TV screen.



2 Press **▲/▼** to select the MP3 then press **ENTER**. The MP3 menu appears on the TV screen.

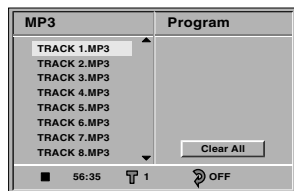

MP3 menu

3 Press **▲/▼** to select a track then press **PLAY**. Playback starts.

During playback, the current track's elapsed playing time will appear on the display.

Playback will stop at the end of the disc.

Press TOP MENU to move to the next page.

Press MENU to move to the previous page.

4 To stop playback at any other time, press **STOP**.

Pause **MP3**

1 Press PAUSE/STEP during playback.

2 To return to playback, press PLAY or press PAUSE/STEP again.

Moving to another Track **MP3**

- Press SKIP (▶▶) or SKIP (◀◀) briefly during playback to advance to the next track or to return to the beginning of the current track.

- Press SKIP (◀◀) twice in quick successions to step back to the previous track.

Repeat Track/All/Off **MP3**

1 To repeat the track currently playing, press REPEAT.



The Repeat Track icon appears on the menu screen.

2 To repeat all tracks on a disc, press REPEAT two times.

The Repeat All icon appears on the menu screen.

3 To cancel Repeat mode, press REPEAT repeatedly until the Repeat Off icon appears on the menu screen.

Note

- The REPEAT button is not available when the  mark appear. Press PROGRAM to clear the  mark.
- If you press SKIP (◀◀) twice or SKIP (▶▶) during Repeat Track playback, the repeat playback cancels.

Notes on MP3 Discs

About MP3

- An MP3 file is audio data compressed by using the MPEG1 audio layer-3 file-coding scheme. We call files that have the “.mp3” file extension “MP3 files”.
- The player cannot read an MP3 file that has a file extension other than “.mp3”.
- The player cannot read a non MP3 encoded file that has a file extension “.mp3”.

MP3 Disc compatibility with this player is limited as follows:

1. Sampling Frequency / only at 44.1kHz
2. Bit rate / within 32 - 320kbps
3. CD-R physical format should be “ISO 9660”
4. If you record MP3 files using the software which cannot create a FILE SYSTEM, for example “Direct-CD” etc., it is impossible to playback MP3 files. We recommend that you use “Easy-CD Creator”, which creates an ISO9660 file system.
5. A single session disc requires MP3 files in the first track. If there is no MP3 file in the 1st track, it cannot playback MP3 files. If you wish to playback MP3 files, format all the data in the disc or use a new one.
6. We do not recommend using CD-RW discs. Please use finished CD-R discs only.
7. File names should be named using 8 letters or less and must incorporate “.mp3” extension e.g. “*****.MP3”.
8. Do not use special letters such as “_?!><+*}{[@] ; V . , ” etc.
9. Total number of files on the disc should be less than 200.
10. Use 74 minute CD-R discs (650M), Do not use 80 minute CD-R (700M) software

This DVD player requires discs/recordings to meet certain technical standards in order to achieve optimal playback quality. Pre-recorded DVDs are automatically set to these standards. There are many different types of recordable disc formats (including CD-R containing MP3 files). That require certain pre-existing conditions (see above) to insure compatible playback.

Customers should also note that permission is required in order to download MP3 files and music from the Internet. TOSHIBA cannot grant such permission. Permission should always be sought from the copyright owner.

Operation with JPEG Disc

Viewing a JPEG disc **JPEG**

This DVD Player can play discs with JPEG files on it. Make sure the resolution of the JPEG files is less than 2 mega pixels (2M).

N Notes

- Depending upon the size and number of the JPEG files, it could take a long time for the DVD player to read the disc's contents. If you don't see an on-screen display after several minutes, some of the files are too big — reduce the resolution of the JPEG files to less than 2 mega pixels and burn another disc.
- Total number of files on the disc should be less than 200.
- Some discs/files may be incompatible due to different recording format or condition of discs/files.

1 Insert a disc and close the tray.

The MP3/JPEG/WMA choice menu appears on the TV screen.



2 Press ▲/▼ to select the JPEG then press ENTER.

The JPEG menu appears on the TV screen. Press RETURN to move to the previous menu (MP3/JPEG/WMA choice menu).

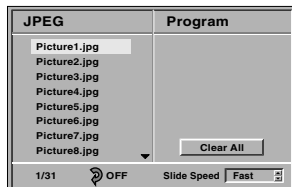

JPEG menu

3 If you want to view a particular file, press ▲/▼ to highlight a file and press ENTER or PLAY.

Viewing the file proceeding starts. During viewing a file, press DISPLAY or RETURN to move to the previous menu (JPEG menu). Press TOP MENU to move to the next page. Press MENU to move to the previous page.

T Tip

There are three viewing Slide Speed options: Fast, Normal, and Slow. Press ◀/▶ to highlight the Slide Speed then press ▲/▼ to select the option you want to use, and press ENTER.

4 To stop viewing at any other time, press STOP.

The JPEG menu appears.

Moving to another File

- Press SKIP (◀◀) or SKIP (▶▶) once during viewing to advance to the next file or to the previous file.

Repeat All/Off

- 1 To repeat all files on a disc, press REPEAT when JPEG menu appears.

The Repeat All icon appears on the menu screen.

- 2 Press PLAY or ENTER to start repeat playback.

- 3 To cancel Repeat mode, first press STOP to stop playback then press REPEAT when JPEG menu appears.

The Repeat Off icon appears on the menu screen.

N Note

The REPEAT button is not available when the [E] mark appear. Press PROGRAM to clear the [E] mark.

Notes on JPEG Files

- When you are using software such as “Easy CD Creator” to burn the jpeg files into the CD-R, ensure that all the selected files have the “.jpg” extensions when copying into the CD layout.
- If the files have “.jpe” or “.jpeg” extensions, please rename them as “.jpg” files.
- File names without “.jpg” extension will not be able to be read by this DVD+VCR. Even though the files are shown as JPEG image files in windows explorer.

Operation with WMA Disc

Playing an WMA disc **WMA**

The DVD Player can play WMA formatted recordings on CD-ROM, CD-R or CD-RW discs.

1 Insert a disc and close the tray.

The MP3/JPEG/WMA choice menu appears on the TV screen.



2 Press ▲/▼ to select the WMA then press ENTER.

The WMA menu appears on the TV screen.

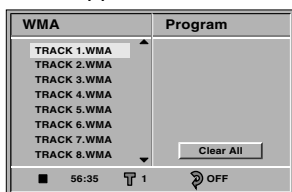

WMA menu

3 Press ▲/▼ to select a track then press PLAY.

Playback starts.

During playback, the current track's elapsed playing time will appear on the display.

Playback will stop at the end of the disc.

Press TOP MENU to move to the next page.

Press MENU to move to the previous page.

4 To stop playback at any other time, press STOP.

Pause **WMA**

1 Press PAUSE/STEP during playback.

2 To return to playback, press PLAY or press PAUSE/STEP again.

Moving to another Track **WMA**

- Press SKIP (▶▶) or SKIP (◀◀) briefly during playback to advance to the next track or to return to the beginning of the current track.
- Press SKIP (◀◀) twice in quick successions to step back to the previous track.

Repeat Track/All/Off **WMA**

1 To repeat the track currently playing, press REPEAT.

The Repeat Track icon appears on the menu screen.

2 To repeat all tracks on a disc, press REPEAT two times.

The Repeat All icon appears on the menu screen.

3 To cancel Repeat mode, press REPEAT repeatedly until the Repeat Off icon appears on the menu screen.

Note

- The REPEAT button is not available when the [E] mark appear. Press PROGRAM to clear the [E] mark.
- If you press SKIP (◀◀) twice or SKIP (▶▶) during Repeat Track playback, the repeat playback will be canceled.

WMA Disc compatibility with this player is limited as follows:

1. Sampling Frequency / within 32 - 44kHz
2. Bit rate / within 48 - 80kbps

Programmed Playback with Audio CD, MP3, JPEG or WMA Disc

Program allows you to store your favorite tracks/files (or files) for a particular disc in the player memory. Program can contain 32 tracks (Audio CD/Video CD) or 60 tracks (MP3/JPEG/WMA disc).

- 1 Insert a disc and close the tray.**
 - The Audio CD menu appears.
 - If MP3, JPEG or WMA disc is inserted, the MP3/JPEG/WMA choice menu appears on the TV screen.

Press ▲/▼ to select the MP3, JPEG or WMA then press ENTER. The MP3, JPEG or WMA menu appears on the TV screen. Press RETURN to move to the previous menu (MP3/JPEG/WMA choice menu).

- 2 Press PROGRAM in the stop mode or during playback (Audio CD, MP3 and WMA only) to enter the Program Edit mode.**

The  mark will appear to the right of the word Program on the right side of the menu screen.

Note

Press PROGRAM to exit the Program Edit mode; the  mark will disappear.

- 3 Press ▲/▼ to select a track/file then press ENTER to place the selected track/file on the Program list.**
- 4 Repeat step 3 to place additional tracks/files on the Program list.**

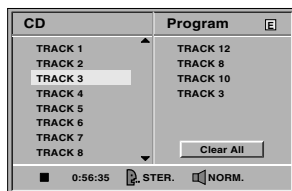

For example: Audio CD menu

- 5 Press ►.**

The programmed track/file you selected last is highlighted on the program list.
- 6 Press ▲/▼ to select the track/file you want to start playing.**

Press TOP MENU to move to the next page.
Press MENU to move to the previous page.
- 7 Press ENTER or PLAY to start.**

Playback begins in the order in which you programmed the tracks/files and "PROG." appears in the display window. Playback stops after playing the last programmed track/file on the program list.

Note

The programmed tracks/files are cleared when the power is turned off or the disc is removed.

Programmed Playback with Video CD

VCD2.0 **VCD1.1**

Note

On a Video CD with PBC, you must set PBC to Off on the setup menu to use the Program function. See page 20.

- 1 Insert Video CD and close the tray.**
- 2 Press PROGRAM while playback is stopped.**

The VCD Program menu will appear.

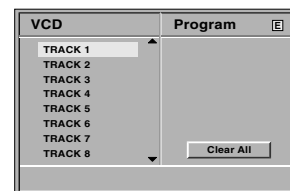

Note

Press RETURN or PROGRAM to exit the Program menu.

- 3 Follow steps 3-7 of "Programmed Playback with Audio CD, MP3, JPEG or WMA Disc" on left.**

Tip

To resume normal playback from programmed playback

Press and hold PROGRAM for 3 seconds until "PROG." indicator disappears in the display window.

Programmed Playback (Continued)

Repeat Programmed Tracks/All/Off

CD **MP3** **WMA**

- 1 To repeat the track currently playing, press REPEAT.
The Repeat Track icon appears on the menu screen.
- 2 To repeat all tracks on the program list, press REPEAT two times.
The Repeat All icon appears on the menu screen.
- 3 To cancel Repeat mode, press REPEAT repeatedly until the Repeat Off icon appears on the menu screen.



Note

If you press SKIP (⏮) twice or SKIP (⏭) during Repeat Track playback, the repeat playback cancels.

Repeat Programmed All/Off **JPEG**

- 1 To repeat all files on the program list, press REPEAT when JPEG menu appears.
The Repeat All icon appears on the menu screen.
- 2 Press PLAY or ENTER to start repeat playback.
- 3 To cancel Repeat mode, first press STOP to stop playback then press REPEAT when JPEG menu appears.

Note



The REPEAT button is not available when the  mark appear. Press PROGRAM to clear the  mark.

Erasing a Track/File from Program List



- 1 Press PROGRAM during playback or in the stop mode to enter the Program Edit mode.
The  mark will appear.

Note

JPEG can be programmed only in stop mode (when menu screen is displayed.)

- 2 Press  to move to the Program list.
- 3 Use / to select the track/file that you wish to erase from the Program list.
- 4 Press CLEAR.
The track/file will be erased from the Program list.

Erasing the Complete Program List

- 1 Follow steps 1-2 of "Erasing a Track/File from Program List" as above.
- 2 Use / to select "Clear All", then press ENTER.
The complete Program for the disc will be erased.
The programs are also cleared when the disc is removed.

One Touch Replay

Press INSTANT REPLAY during playback and the disc will reverse picture search through 10 seconds of playback. And then the playback will start from the point again.

Screen Saver

A screen saver image appears when you leave the DVD Player in stop mode for about five minutes.

Video Mode Setting **DVD** **VCD2.0** **VCD1.1**

- With certain discs, the playback picture may be flickering or Dot Crawl is shown on straight lines. That means Vertical interpolation or De-interlace is not perfectly matched with the disc. In this case, the picture quality may be improved by changing the video mode.
- To change the video mode, press and hold DISPLAY about 3 seconds during disc playback. The new video mode number selected is displayed on the TV screen. Check whether the video quality has improved. If not, repeat the above procedure until picture quality is improved.
- Video mode sequence:
Video1 → Video2 → Film → Adapt → Auto.
- If you turn off the power, the video mode will return to initial default state (Auto).

Detailed Description of each Video Mode

Auto : The source material of the DVD video (film material or video material) is determined from disc information.

Video1 : Suitable for playing video based content with comparatively little motion.

Video2 : Suitable for playing video based content with comparatively more motion.

Film : Suitable for playing film based content or video based material recorded by the progressive scan method.

Adapt : Determines the appropriate mode (film or video) during disc playback, and automatically selects the proper mode. Suitable for playing a disc comprised of film and video based content.

Troubleshooting

Check the following guide for the possible cause of a problem before contacting service.

Symptom	Cause	Correction
No power.	<ul style="list-style-type: none"> The power cord is disconnected. 	<ul style="list-style-type: none"> Plug the power cord into the wall outlet securely.
The power is on, but the DVD+VCR does not work.	<ul style="list-style-type: none"> No disc is inserted. No tape is inserted. 	<ul style="list-style-type: none"> Insert a disc or tape. (Check that the disc or tape indicator in the display window is lit.)
No picture.	<ul style="list-style-type: none"> The TV is not set to receive DVD+VCR signal output. 	<ul style="list-style-type: none"> Select the appropriate video input mode on the TV so the picture from the DVD+VCR appears on the TV screen.
	<ul style="list-style-type: none"> TV/VCR mode for DVD+VCR is set to TV. 	<ul style="list-style-type: none"> Press the TV/VCR button on the remote control repeatedly to choose VCR mode. TV indicator disappears in the display window.
	<ul style="list-style-type: none"> The video cable is not connected securely. 	<ul style="list-style-type: none"> Connect the video cable securely.
	<ul style="list-style-type: none"> The connected TV power is turned off. 	<ul style="list-style-type: none"> Turn on the TV.
No sound.	<ul style="list-style-type: none"> The equipment connected with the audio cable is not set to receive DVD+VCR signal output. 	<ul style="list-style-type: none"> Select the correct input mode of the audio receiver so you can listen to the sound from the DVD+VCR.
	<ul style="list-style-type: none"> The audio cables are not connected securely. 	<ul style="list-style-type: none"> Connect the audio cable securely.
	<ul style="list-style-type: none"> The power of the equipment connected with the audio cable is turned off. 	<ul style="list-style-type: none"> Turn on the equipment connected with the audio cable.
	<ul style="list-style-type: none"> The Digital Audio Output is set to the wrong position. 	<ul style="list-style-type: none"> Set the Digital Audio Output to the correct position, then turn on the DVD+VCR again by pressing POWER.
The playback picture is poor.	<ul style="list-style-type: none"> The disc is dirty. 	<ul style="list-style-type: none"> Clean the disc.
	<ul style="list-style-type: none"> Tape heads are dirty. 	<ul style="list-style-type: none"> Clean video heads.
	<ul style="list-style-type: none"> Tape is a rental or was recorded on another VCR. 	<ul style="list-style-type: none"> Use CH/TRK (+/-) for manual tracking adjustment while tape is playing.
The DVD+VCR does not start playback.	<ul style="list-style-type: none"> No disc is inserted. No tape is inserted. 	<ul style="list-style-type: none"> Insert a disc or tape. (Check that the disc or tape indicator in the display window is lit.)
	<ul style="list-style-type: none"> An unplayable disc is inserted. 	<ul style="list-style-type: none"> Insert a playable disc. (Check the disc type, color system, and Regional code.)
	<ul style="list-style-type: none"> The disc is placed upside down. 	<ul style="list-style-type: none"> Place the disc with the playback side down.
	<ul style="list-style-type: none"> The disc is not placed within the guide. 	<ul style="list-style-type: none"> Place the disc on the disc tray correctly inside the guide.
	<ul style="list-style-type: none"> The disc is dirty. 	<ul style="list-style-type: none"> Clean the disc.
	<ul style="list-style-type: none"> The Rating level is set. 	<ul style="list-style-type: none"> Cancel the Rating function or change the rating level.
The remote control does not work properly.	<ul style="list-style-type: none"> The remote control is not pointed at the remote sensor of the DVD+VCR. 	<ul style="list-style-type: none"> Point the remote control at the remote sensor of the DVD+VCR.
	<ul style="list-style-type: none"> The remote control is too far from the DVD+VCR. 	<ul style="list-style-type: none"> Operate the remote control within 23 ft (7 m).
	<ul style="list-style-type: none"> There is an obstacle in the path of the remote control and the DVD+VCR. 	<ul style="list-style-type: none"> Remove the obstacle.
	<ul style="list-style-type: none"> The batteries in the remote control are exhausted. 	<ul style="list-style-type: none"> Replace the batteries with new ones.
	<ul style="list-style-type: none"> This remote control use the same buttons for VCR and DVD functions (ex. PLAY). 	<ul style="list-style-type: none"> When using a VCR, first press the VCR button. When using a DVD, first press the DVD button.

Troubleshooting (Continued)

Symptom	Cause	Correction
Some channels are skipped over when using CH/TRK (+/-)	<ul style="list-style-type: none"> Those channels were deleted with the CH. ADD/DEL option. 	<ul style="list-style-type: none"> Use CH. ADD/DEL. to restore channels. See "Channel Selection" on page 16.
Picture and sound of broadcasting channel are weak or missing.	<ul style="list-style-type: none"> Antenna or cables are loose. 	<ul style="list-style-type: none"> Tighten connections or replace cable.
	<ul style="list-style-type: none"> Wrong TUNING BAND option is being used. 	<ul style="list-style-type: none"> Try all TUNING BAND options. See "Channel Selection" on page 16 for details.
Camcorder image is not shown.	<ul style="list-style-type: none"> Camcorder is off. 	<ul style="list-style-type: none"> Turn camcorder on and operate properly.
Camcorder image via A/V input to DVD+VCR is not shown on TV screen.	<ul style="list-style-type: none"> DVD+VCR SOURCE SELECT is not set to LINE1 or LINE2. 	<ul style="list-style-type: none"> Press INPUT SELECT to select LINE input channel (LINE1 or LINE2).
Timer recording is not possible.	<ul style="list-style-type: none"> Clock in DVD+VCR is not set to correct time. 	<ul style="list-style-type: none"> Set clock to correct time. See "Setting the Clock" on page 17.
	<ul style="list-style-type: none"> Timer has been programmed incorrectly. 	<ul style="list-style-type: none"> Reprogram Timer. See "Timer Recording" on page 24.
	<ul style="list-style-type: none"> TIMER indicator does not appear after programming timer. 	<ul style="list-style-type: none"> Reprogram Timer
TIMER indicator appears after DVD+VCR is turned off.	<ul style="list-style-type: none"> DVD+VCR is in Timer Recording mode. 	<ul style="list-style-type: none"> This is the normal indication that the DVD+VCR is in TIMER mode.
Stereo Audio Record and/or Playback is not present.	<ul style="list-style-type: none"> TV is not Stereo-compatible. 	<ul style="list-style-type: none"> No action is possible.
	<ul style="list-style-type: none"> Broadcast program is not in stereo format. 	<ul style="list-style-type: none"> No action is possible.
	<ul style="list-style-type: none"> DVD+VCR A/V Out jacks are not connected to TV A/V In jacks. 	<ul style="list-style-type: none"> Make A/V connections. Stereo is available only via A/V output from DVD+VCR.
	<ul style="list-style-type: none"> DVD+VCR Audio/Video Out is not selected for viewing at the TV. 	<ul style="list-style-type: none"> Select AUX or A/V source as TV input.
	<ul style="list-style-type: none"> DVD+VCR BROADCAST TYPE mode is set to SAP or MONO. 	<ul style="list-style-type: none"> Set BROADCAST TYPE mode to STEREO. See "Setting the VCR Setup Menu" on page 16.

Moisture Condensation

Moisture condensation can occur:	In locations where moisture condensation may occur:
<ul style="list-style-type: none"> When the DVD+VCR is moved from a cold place to a warm place. Under extremely humid conditions. 	<ul style="list-style-type: none"> Keep the DVD+VCR plugged into an AC power outlet with POWER On. This will help prevent condensation. When condensation has occurred, wait a few hours for the DVD+VCR to dry before using it.

Language Code List

Enter the appropriate code number for the initial settings “Disc Audio”, “Disc Subtitle” and/or “Disc Menu” (See page 19).

Code	Language	Code	Language	Code	Language	Code	Language
6566	Abkhazian	7074	Fiji	7678	Lingala	8373	Singhalese
6565	Afar	7073	Finnish	7684	Lithuanian	8375	Slovak
6570	Afrikaans	7082	French	7775	Macedonian	8376	Slovenian
8381	Albanian	7089	Frisian	7771	Malagasy	8379	Somali
6577	Amharic	7176	Galician	7783	Malay	6983	Spanish
6582	Arabic	7565	Georgian	7776	Malayalam	8385	Sudanese
7289	Armenian	6869	German	7784	Maltese	8387	Swahili
6583	Assamese	6976	Greek	7773	Maori	8386	Swedish
6588	Aymara	7576	Greenlandic	7782	Marathi	8476	Tagalog
6590	Azerbaijani	7178	Guarani	7779	Moldavian	8471	Tajik
6665	Bashkir	7185	Gujarati	7778	Mongolian	8465	Tamil
6985	Basque	7265	Hausa	7865	Nauru	8484	Tatar
6678	Bengali; Bangla	7387	Hebrew	7869	Nepali	8469	Telugu
6890	Bhutani	7273	Hindi	7879	Norwegian	8472	Thai
6672	Bihari	7285	Hungarian	7982	Oriya	6679	Tibetan
6682	Breton	7383	Icelandic	8065	Panjabi	8473	Tigrinya
6671	Bulgarian	7378	Indonesian	8083	Pashto, Pushto	8479	Tonga
7789	Burmese	7365	Interlingua	7065	Persian	8482	Turkish
6669	Byelorussian	7165	Irish	8076	Polish	8475	Turkmen
7577	Cambodian	7384	Italian	8084	Portuguese	8487	Twi
6765	Catalan	7465	Japanese	8185	Quechua	8575	Ukrainian
9072	Chinese	7487	Javanese	8277	Rhaeto-Romance	8582	Urdu
6779	Corsican	7578	Kannada	8279	Romanian	8590	Uzbek
7282	Croatian	7583	Kashmiri	8285	Russian	8673	Vietnamese
6783	Czech	7575	Kazakh	8377	Samoan	8679	Volapük
6865	Danish	7589	Kirghiz	8365	Sanskrit	6789	Welsh
7876	Dutch	7579	Korean	7168	Scots Gaelic	8779	Wolof
6978	English	7585	Kurdish	8382	Serbian	8872	Xhosa
6979	Esperanto	7679	Laothian	8372	Serbo-Croatian	7473	Yiddish
6984	Estonian	7665	Latin	8378	Shona	8979	Yoruba
7079	Faeroese	7686	Latvian, Lettish	8368	Sindhi	9085	Zulu

Country/Area Code List

Enter the appropriate code number for the initial setting "Area Code" (See page 21).

Code	Country/Area	Code	Country/Area	Code	Country/Area	Code	Country/Area
AD	Andorra	ER	Eritrea	LC	Saint Lucia	SC	Seychelles
AE	United Arab Emirates	ES	Spain	LI	Liechtenstein	SD	Sudan
AF	Afghanistan	ET	Ethiopia	LK	Sri Lanka	SE	Sweden
AG	Antigua and Barbuda	FI	Finland	LR	Liberia	SG	Singapore
AI	Anguilla	FJ	Fiji	LS	Lesotho	SH	Saint Helena
AL	Albania	FK	Falkland Islands	LT	Lithuania	SI	Slovenia
AM	Armenia	FM	Micronesia	LU	Luxembourg	SJ	Svalbard and Jan Mayen Islands
AN	Netherlands Antilles	FO	Faroe Islands	LV	Latvia	SK	Slovak Republic
AO	Angola	FR	France	LY	Libya	SL	Sierra Leone
AQ	Antarctica	FX	France (European Territory)	MA	Morocco	SM	San Marino
AR	Argentina	GA	Gabon	MC	Monaco	SN	Senegal
AS	American Samoa	GB	Great Britain	MD	Moldavia	SO	Somalia
AT	Austria	GD	Grenada	MG	Madagascar	SR	Suriname
AU	Australia	GE	Georgia	MH	Marshall Islands	ST	Saint Tome and Principe
AW	Aruba	GF	French Guyana	MK	Macedonia	SV	Former USSR
AZ	Azerbaijan	GH	Ghana	ML	Mali	SU	El Salvador
BA	Bosnia-Herzegovina	GI	Gibraltar	MM	Myanmar	SY	Syria
BB	Barbados	GL	Greenland	MN	Mongolia	SZ	Swaziland
BD	Bangladesh	GM	Gambia	MO	Macau	TC	Turks and Caicos Islands
BE	Belgium	GN	Guinea	MP	Northern Mariana Islands	TD	Chad
BF	Burkina Faso	GP	Guadeloupe (French)	MQ	Martinique (French)	TF	French Southern Territories
BG	Bulgaria	GQ	Equatorial Guinea	MR	Mauritania	TG	Togo
BH	Bahrain	GR	Greece	MS	Montserrat	TH	Thailand
BI	Burundi	GS	S. Georgia & S. Sandwich Isls.	MT	Malta	TJ	Tadjikistan
BJ	Benin	GT	Guatemala	MU	Mauritius	TK	Tokelau
BM	Bermuda	GU	Guam (USA)	MV	Maldives	TM	Turkmenistan
BN	Brunei Darussalam	GW	Guinea Bissau	MW	Malawi	TN	Tunisia
BO	Bolivia	GY	Guyana	MX	Mexico	TO	Tonga
BR	Brazil	HK	Hong Kong	MY	Malaysia	TP	East Timor
BS	Bahamas	HM	Heard and McDonald Islands	MZ	Mozambique	TR	Turkey
BT	Bhutan	HN	Honduras	NA	Namibia	TT	Trinidad and Tobago
BV	Bouvet Island	HR	Croatia	NC	New Caledonia (French)	TV	Tuvalu
BW	Botswana	HT	Haiti	NE	Niger	TW	Taiwan
BY	Belarus	HU	Hungary	NF	Norfolk Island	TZ	Tanzania
BZ	Belize	ID	Indonesia	NG	Nigeria	UA	Ukraine
CA	Canada	IE	Ireland	NI	Nicaragua	UG	Uganda
CC	Cocos (Keeling) Islands	IL	Israel	NL	Netherlands	UK	United Kingdom
CF	Central African Republic	IN	India	NO	Norway	UM	USA Minor Outlying Islands
CG	Congo	IO	British Indian Ocean Territory	NP	Nepal	US	United States
CH	Switzerland	IQ	Iraq	NR	Nauru	UY	Uruguay
CI	Ivory Coast	IR	Iran	NU	Niue	UZ	Uzbekistan
CK	Cook Islands	IS	Iceland	NZ	New Zealand	VA	Vatican City State
CL	Chile	IT	Italy	OM	Oman	VC	Saint Vincent & Grenadines
CM	Cameroon	JM	Jamaica	PA	Panama	VE	Venezuela
CN	China	JO	Jordan	PE	Peru	VG	Virgin Islands (British)
CO	Colombia	JP	Japan	PF	Polynesia (French)	VI	Virgin Islands (USA)
CR	Costa Rica	KE	Kenya	PG	Papua New Guinea	VN	Vietnam
CS	Former Czechoslovakia	KG	Kyrgyzstan	PH	Philippines	VU	Vanuatu
CU	Cuba	KH	Kambodia ⁶	PK	Pakistan	WF	Wallis and Futuna Islands
CV	Cape Verde	KI	Kiribati	PL	Poland	WS	Samoa
CX	Christmas Island	KM	Comoros	PM	Saint Pierre and Miquelon	YE	Yemen
CY	Cyprus	KN	Saint Kitts & Nevis Anguilla	PN	Pitcairn Island	YT	Mayotte
CZ	Czech Republic	KP	North Korea	PR	Puerto Rico	YU	Yugoslavia
DE	Germany	KR	South Korea	PT	Portugal	ZA	South Africa
DJ	Djibouti	KW	Kuwait	PW	Palau	ZM	Zambia
DK	Denmark	KY	Cayman Islands	PY	Paraguay	ZR	Zaire
DM	Dominica	KZ	Kazakhstan	QA	Qatar	ZW	Zimbabwe
DO	Dominican Republic	LA	Laos	RE	Reunion (French)		
DZ	Algeria	LB	Lebanon	RO	Romania		
EC	Ecuador			RU	Russian Federation		
EE	Estonia			RW	Rwanda		
EG	Egypt			SA	Saudi Arabia		
EH	Western Sahara			SB	Solomon Islands		

Specifications

General

Power requirements	AC 120V , 60 Hz
Power consumption	23W
Dimensions (approx.)	430 X 97.5 X 293 mm (16.9 x 3.9 x 11.5 inches) (w x h x d)
Mass (approx.)	4.8 kg (10.58 lbs)
Operating temperature	5°C to 40°C (41°F to 104°F)
Operating humidity	5 % to 90 %
Signal system	NTSC

Inputs

ANTENNA IN	Antenna or CATV input, 75 ohms
VHS VIDEO IN (LINE1, 2)	1 Vp-p 75 ohms, sync negative, RCA jack x 2
VHS AUDIO IN (LINE1, 2)	-6.0 dBm more than 47 kohms, RCA jack (L, R) x 2

Outputs

VIDEO OUT	1 Vp-p 75 ohms, sync negative
S-VIDEO OUT	(Y) 1.0 V (p-p), 75 ohms, negative sync, Mini DIN 4-pin x 1 (C) 0.3 V (p-p) 75 ohms
COMPONENT VIDEO OUT (Progressive Scan)	(Y) 1.0 V (p-p), 75 ohms, negative sync, RCA jack x 1 (Pb)/(Pr) 0.7 V (p-p), 75 ohms, RCA jack x 2
Audio output (digital audio)	0.5 V (p-p), 75 ohms, RCA jack x 1
Audio output (optical audio)	5 V (p-p), 75 Ω, Optical connector x 1
Audio output (analog audio)	2.0 Vrms (1 KHz, 0 dB), 330 ohms, RCA jack (L, R) x 1
RF OUT	Channel 3 or 4

VCR Specifications

Head system	Four head helical scan azimuth system
Timer	12-hour display type with AM, PM
Tape speed	SP: 33.35 mm/sec, LP: 16.67 mm/sec, SLP: 11.12 mm/sec
Tape width	12.7 mm
Maximum recording time	SP: 2 HOURS (T-120), SLP: 6 HOURS (T-120)/8 HOURS (T-160)
Rewind time	About 3 minutes (T-120)
Antenna	75 ohms (VHF/UHF)
VHF output signal	Channel 3 or 4 (Switchable)
Channel coverage	VHF: 2-13, UHF: 14-69, CATV: 1-125 (4A, A-W, W+1 - W+84, A-5 - A-1)
Frequency range	20Hz to 20kHz
Signal-to-noise ratio	More than 43dB
Dynamic range	More than 88 dB
Channel separation	More than 60 dB

DVD Specifications

Laser system	Semiconductor laser, wavelength 650 nm
Frequency response	DVD (PCM 96 kHz): 8 Hz to 44 kHz, DVD (PCM 48 kHz): 8 Hz to 22 kHz CD: 8 Hz to 20 kHz
Signal-to-noise ratio	More than 100dB (ANALOG OUT jacks only)
Harmonic distortion	Less than 0.008%
Dynamic range	More than 95 dB (DVD/CD)

Accessory:

Video cable x 1, Audio cable x 1, RF 75-ohm Coaxial Cable x 1, Remote control x 1, Batteries(AAA) x 2

- Design and specifications are subject to change without notice.

Manufactured under license from Dolby Laboratories. Dolby and the double-D symbol are trademarks of Dolby Laboratories. Confidential unpublished works. Copyright 1992-1997 Dolby Laboratories. All rights reserved.

DTS and DTS Digital Out are trademarks of Digital Theater Systems, Inc.

LIMITED WARRANTY DVD VIDEO PLAYER

Toshiba America Consumer Products, Inc. ("TACP"), Toshiba Hawaii ("THI") and Toshiba Canada Limited ("TCL") make the following limited warranties. These limited warranties extend to original purchaser or any person receiving this set as a gift from the original purchaser and to no other purchaser or transferee.

Limited Ninety (90) Day Warranty

TACP/THI warrant this product against defects in materials or workmanship for a period of ninety (90) days after the date of original retail purchase. During this period, TACP/THI will repair or replace a defective product or part, at their option, with a new or refurbished product or part without charge to you. You must deliver the entire product to a TACP/THI Authorized Service Station. You are responsible for all transportation and insurance charges for the unit to and from the Authorized Service Station. If you live in the U.S.A. you may, at your option, return your DVD Unit to:

Toshiba America Consumer Products Inc.
Returns Center
1420C Toshiba Dr.
Lebanon, TN 37087

Upon receipt we will, at our option, exchange the DVD Unit with a new or refurbished unit. **Canadian consumers are requested to contact TCL. In Hawaii consumers are requested to contact THI.**

Limited One (1) Year Warranty

TACP/THI further warrant the parts in this product against defects in materials or workmanship for a period of one (1) year after the date of original retail purchase. During this period, TACP/THI will repair or replace a defective product or part, at their option, with a new or refurbished product or part without charge to you, except that if a defective part is replaced after ninety (90) days from the date of the original retail purchase you pay labor charges involved in the replacement. You must also deliver the entire product to a TACP/THI Authorized Service Station. You are responsible for all transportation and insurance charges for the unit to and from the Authorized Service Station. If you live in the U.S.A. you may, at your option, return your DVD Unit to:

Toshiba America Consumer Products Inc.
Returns Center
1420C Toshiba Dr.
Lebanon, TN 37087

Upon receipt we will, at our option, exchange the DVD Unit with a new or refurbished unit. **Canadian Consumers are requested to contact TCL. In Hawaii consumers are requested to contact THI.**

Rental Units

The warranty for rental units begin with the first rental or thirty (30) days from the date of shipment to the rental firm, whichever comes first.

Commercial Units

Products sold and used for commercial use have a limited ninety (90) day warranty for all parts and labor.

Owner's Manual

You should read the owner's manual thoroughly before operating this product. You should complete and mail the enclosed Demographic card within ten (10) days after you, or the person who has given you this product as a gift, purchased this product. This is one way to enable TACP to provide you with better customer service and improved products. Failure to return the card will not affect your rights under this warranty.

Your Responsibility

The above warranties are subject to the following conditions:

- (1) You must retain your bill of sale or provide other proof of purchase.
- (2) You must notify a TACP/THI/TCL /Authorized Service Station within thirty (30) days after you discover a defective product or part.
- (3) All warranty servicing of this product must be made by a TACP/THI/TCL Authorized Service Station.
- (4) U.S.A. warranties are effective only if the product is purchased and operated in the Continental U.S.A. or Puerto Rico.
- (5) Labor service charges for set installation. Set up, adjustment of customer controls and installation or repair of antenna systems are not covered by this warranty. Reception problems caused by inadequate antenna systems are your responsibility.
- (6) Warranties extend only to defects in materials or workmanship as limited above and do not extend to any product or parts which have been lost or discarded by you or to damage to products or parts caused by misuse, accident, damage caused by Acts of God, such as lightning or fluctuations in electric power, improper installation, improper maintenance or use in violation of instructions furnished by us; or to units which have been altered or modified without authorization of TACP/THI/TCL or to damage to products or part thereof which have had the serial number removed, altered, defaced or rendered illegible.
- (7) Should you elect to return your DVD Unit to TACP after the ninety (90) days and within one (1) year, or after the warranty period has expired: Call (800)-631-3811 to receive information concerning an exchange price. Payment must be enclosed with product in the form of a certified check or money order including reason for return.
- (8) Physically damaged DVD Units are not acceptable for repair or exchange whether in or out of warranty and will be returned as received.

(Continued)

LIMITED WARRANTY DVD VIDEO PLAYER (Continued)

How to Obtain Warranty Service

- (1) Refer to the troubleshooting guide in your owner's manual. This check list may solve your problem.
- (2) In the U.S.A., only call the TACP toll free number 800-631-3811, or if in Hawaii or Canada see listing below within (30) days after you find a defective product or part.
- (3) Arrange for the delivery of the product to the TACP/THI/TCL Authorized Service Station or TACP Return Center. Products shipped to the Service Station must be insured and safely and securely packed, preferably in the original shipping carton, and a letter explaining the defect and also a copy of the bill of sale or other proof of purchase must be enclosed.

In the Continental United States contact:



In Hawaii contact:

Toshiba Hawaii Inc.
327 Kamakee Street
Honolulu, HA 96814
(808)-521-5377

In Canada contact:

Consumer Electronics Group
191 McNabb Street
Markham, Ontario L3R 8H2
(905)-470-5400

Consumer Electronics Group
22171 Fraserwood Way
Richmond, B.C. V6W 1J5
(604)-303-2500

Consumer Electronics Group
1643 North Service Road
Droval, QC H9P 1J1
(514)-856-4100

All warranties implied by state law, including the implied warranties of merchantability and fitness for a particular purpose, are expressly limited to the duration of the limited warranties set forth above. With the exception of any warranties implied by state law as hereby limited, the foregoing warranty is exclusive and in lieu of all other warranties, guarantees, agreements and similar obligations of manufacturer or seller with respect to the repair or replacement of any parts. In no event shall TACP/THI be liable for consequential or incidental damages.

No person, agent, distributor, dealer or company is authorized to change, modify or extend the terms of these warranties in any manner whatsoever. The time within which an action must be commenced to enforce any obligation of TACP/THI arising under the warranty or under any statute, or law of the United States or any state thereof, is hereby limited to ninety (90) days from the date you discover or should have discovered, the defect. This limitation does not apply to implied warranties arising under state law. This warranty gives you specific legal rights and you may also have other rights which may vary from state to state. Some states do not allow limitation on how long an implied warranty lasts, when an action may be brought, or the exclusion or limitation of incidental or consequential damages, so the above provisions may not apply to you.

ATTENTION CANADIAN CONSUMERS:

Canadian consumers are requested to complete the special Canadian "Warranty Registration Form" enclosed, and forward this completed form with a copy of bill of sale to TOSHIBA OF CANADA to "Register and Validate" their warranty. Product must be purchased from an Authorized Canadian Dealer. Products purchased in the U.S.A. and used in Canada are not covered by these warranties.

IMPORTANT: PACKING AND SHIPPING INSTRUCTION

When you send the product to a Service Station, you must use the original carton box and packing material, then insert the original carton box containing the unit into another carton using more packing material.

PRODUCT SAFETY SERVICING GUIDELINES FOR VIDEO PRODUCTS

CAUTION : DO NOT ATTEMPT TO MODIFY THIS PRODUCT IN ANY WAY, NEVER PERFORM CUSTOMIZED INSTALLATIONS WITHOUT MANUFACTURER'S APPROVAL. UNAUTHORIZED MODIFICATIONS WILL NOT ONLY VOID THE WARRANTY, BUT MAY LEAD TO YOUR BEING LIABLE FOR ANY RESULTING PROPERTY DAMAGE OR USER INJURY.

SERVICE WORK SHOULD BE PERFORMED ONLY AFTER YOU ARE THOROUGHLY FAMILIAR WITH ALL OF THE FOLLOWING SAFETY CHECKS AND SERVICING GUIDELINES. TO DO OTHERWISE, INCREASES THE RISK OF POTENTIAL HAZARDS AND INJURY TO THE USER.

WHILE SERVICING, USE AN ISOLATION TRANSFORMER FOR PROTECTION FROM A.C. LINE SHOCK.

SAFETY CHECKS

AFTER THE ORIGINAL SERVICE PROBLEM HAS BEEN CORRECTED, A CHECK SHOULD BE MADE OF THE FOLLOWING.

SUBJECT : FIRE & SHOCK HAZARD

1. BE SURE THAT ALL COMPONENTS ARE POSITIONED IN SUCH A WAY AS TO AVOID POSSIBILITY OF ADJACENT COMPONENT SHORTS. THIS IS ESPECIALLY IMPORTANT ON THOSE MODULES WHICH ARE TRANSPORTED TO AND FROM THE REPAIR SHOP.
2. NEVER RELEASE A REPAIR UNLESS ALL PROTECTIVE DEVICES SUCH AS INSULATORS, BARRIERS, COVERS, SHIELDS, STRAIN RELIEFS, POWER SUPPLY CORDS, AND OTHER HARDWARE HAVE BEEN REINSTALLED PER ORIGINAL DESIGN. BE SURE THAT THE SAFETY PURPOSE OF THE POLARIZED LINE PLUG HAS NOT BEEN DEFEATED.
3. SOLDERING MUST BE INSPECTED TO DISCOVER POSSIBLE COLD SOLDER JOINTS, SOLDER SPLASHES OR SHARP SOLDER POINTS. BE CERTAIN TO REMOVE ALL LOOSE FOREIGN PARTICLES.
4. CHECK FOR PHYSICAL EVIDENCE OF DAMAGE OR DETERIORATION TO PARTS AND COMPONENTS. FOR FRAYED LEADS, DAMAGED INSULATION (INCLUDING A.C. CORD), AND REPLACE IF NECESSARY FOLLOW ORIGINAL LAYOUT, LEAD LENGTH AND DRESS.
5. NO LEAD OR COMPONENT SHOULD TOUCH A RECEIVING TUBE OR A RESISTOR RATED AT 1 WATT OR MORE. LEAD TENSION AROUND PROTRUDING METAL SURFACES MUST BE AVOIDED.
6. ALL CRITICAL COMPONENTS SUCH AS FUSES, FLAMEPROOF RESISTORS, CAPACITORS, ETC. MUST BE REPLACED WITH EXACT FACTORY TYPES, DO NOT USE REPLACEMENT COMPONENTS OTHER THAN THOSE SPECIFIED OR MAKE UNRECOMMENDED CIRCUIT MODIFICATIONS.
7. AFTER RE-ASSEMBLY OF THE SET ALWAYS PERFORM AN A.C. LEAKAGE TEST ON ALL EXPOSED METALLIC PARTS OF THE CABINET, (THE CHANNEL SELECTOR KNOB, ANTENNA TERMINALS, HANDLE AND SCREWS) TO BE SURE THE SET IS SAFE TO OPERATE WITHOUT DANGER OF ELECTRICAL SHOCK. DO NOT USE A LINE ISOLATION TRANSFORMER DURING THIS TEST USE AN A.C. VOLT-METER, HAVING 5000 OHMS PER VOLT OR MORE SENSITIVITY, IN THE FOLLOWING MANNER; CONNECT A 1500 OHM 10 WATT RESISTOR, PARALLELED BY A .15 MFD. 150.V A.C TYPE CAPACITOR BETWEEN A KNOWN GOOD EARTH GROUND (WATER PIPE, CONDUIT, ETC.) AND THE EXPOSED METALLIC PARTS, ONE AT A TIME. MEASURE THE A.C. VOLTAGE ACROSS THE COMBINATION OF 1500 OHM RESISTOR AND .15 MFD CAPACITOR. REVERSE THE A.C. PLUG AND REPEAT A.C. VOLTAGE MEASUREMENTS FOR EACH EXPOSED METALLIC PART. VOLTAGE MEASURED MUST NOT EXCEED 75 VOLTS R.M.S. THIS CORRESPONDS TO 0.5 MILLIAMP A.C ANY VALUE EXCEEDING THIS LIMIT CONSTITUTES A POTENTIAL SHOCK HAZARD AND MUST BE CORRECTED IMMEDIATELY.

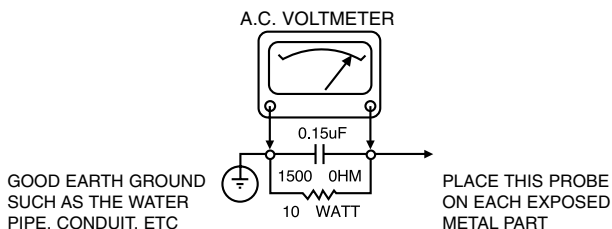

SUBJECT: GRAPHIC SYMBOLS



THE LIGHTNING FLASH WITH APROWHEAD SYMBOL, WITHIN AN EQUILATERAL TRIANGLE, IS INTENDED TO ALERT THE SERVICE PERSONNEL TO THE PRESENCE OF UNINSULATED "DANGEROUS VOLTAGE" THAT MAY BE OF SUFFICIENT MAGNITUDE TO CONSTITUTE A RISK OF ELECTRIC SHOCK.



THE EXCLAMATION POINT WITHIN AN EQUILATERAL TRIANGLE IS INTENDED TO ALERT THE SERVICE PERSONNEL TO THE PRESENCE OF IMPORTANT SAFETY INFORMATION IN SERVICE LITERATURE.

SUBJECT : X-RADIATION

1. BE SURE PROCEDURES AND INSTRUCTIONS TO ALL SERVICE PERSONNEL COVER THE SUBJECT OF X-RADIATION. THE ONLY POTENTIAL SOURCE OF X-RAYS IN CURRENT T.V. RECEIVERS IS THE PICTURE TUBE. HOWEVER, THIS TUBE DOES NOT EMIT X-RAYS WHEN THE HIGH VOLTAGE IS AT THE FACTORY SPECIFIED LEVEL. THE PROPER VALUE IS GIVEN IN THE APPLICABLE SCHEMATIC. OPERATION AT HIGHER VOLTAGES MAY CAUSE A FAILURE OF THE PICTURE TUBE OR HIGH VOLTAGE SUPPLY AND, UNDER CERTAIN CIRCUMSTANCES, MAY PRODUCE RADIATION IN EXCESS OF DESIRABLE LEVELS.
2. ONLY FACTORY SPECIFIED C.R.T. ANODE CONNECTORS MUST BE USED. DEGAUSSING SHIELDS ALSO SERVE AS X-RAY SHIELD IN COLOR SETS, ALWAYS RE-INSTALL THEM.
3. IT IS ESSENTIAL THAT SERVICE PERSONNEL HAVE AVAILABLE AN ACCURATE AND RELIABLE HIGH VOLTAGE METER. THE CALIBRATION OF THE METER SHOULD BE CHECKED PERIODICALLY AGAINST A REFERENCE STANDARD, SUCH AS THE ONE AVAILABLE AT YOUR DISTRIBUTOR.
4. WHEN THE HIGH VOLTAGE CIRCUITRY IS OPERATING PROPERLY THERE IS NO POSSIBILITY OF AN X-RADIATION PROBLEM. EVERY TIME A COLOR CHASSIS IS SERVICED, THE BRIGHTNESS SHOULD BE RUN UP AND DOWN WHILE MONITORING THE HIGH VOLTAGE WITH A METER TO BE CERTAIN THAT THE HIGH VOLTAGE DOES NOT EXCEED THE SPECIFIED VALUE AND THAT IT IS REGULATING CORRECTLY, WE SUGGEST THAT YOU AND YOUR SERVICE ORGANIZATION REVIEW TEST PROCEDURES SO THAT VOLTAGE REGULATION IS ALWAYS CHECKED AS A STANDARD SERVICING PROCEDURE. AND THAT THE HIGH VOLTAGE READING BE RECORDER ON EACH CUSTOMER'S INVOICE.
5. WHEN TROUBLESHOOTING AND MAKING TEST MEASUREMENTS IN A PRODUCT WITH A PROBLEM OF EXCESSIVE HIGH VOLTAGE, AVOID BEING UNNECESSARILY CLOSE TO THE PICTURE TUBE AND THE HIGH VOLTAGE SUPPLY. DO NOT OPERATE THE PRODUCT LONGER THAN IS NECESSARY TO LOCATE THE CAUSE OF EXCESSIVE VOLTAGE.
6. REFER TO HV. B+ AND SHUTDOWN ADJUSTMENT PROCEDURES DESCRIBED IN THE APPROPRIATE SCHEMATIC AND DIAGRAMS (WHERE USED).

SUBJECT: IMPLOSION

1. ALL DIRECT VIEWED PICTURE TUBES ARE EQUIPPED WITH AN INTEGRAL IMPLOSION PROTECTION SYSTEM, BUT CARE SHOULD BE TAKEN TO AVOID DAMAGE DURING INSTALLATION, AVOID SCRATCHING THE TUBE. IF SCRATCHED REPLACE IT.

2. USE ONLY RECOMMENDED FACTORY REPLACEMENT TUBES.

SUBJECT : TIPS ON PROPER INSTALLATION

1. NEVER INSTALL ANY PRODUCT IN A CLOSED-IN RECESS, CUBBY-HOLE OR CLOSELY FITTING SHELF SPACE. OVER OR CLOSE TO HEAT DUCT, OR IN THE PATH OF HEATED AIR FLOW.
2. AVOID CONDITIONS OF HIGH HUMIDITY SUCH AS: OUTDOOR PATIO INSTALLATIONS WHERE DEW IS A FACTOR, NEAR STEAM RADIATORS WHERE STEAM LEAKAGE IS A FACTOR, ETC.
3. AVOID PALCEMENT WHERE DRAPERIES MAY OBSTRUCT REAR VENTING. THE CUSTOMER SHOULD ALSO AVOID THE USE OF DECORATIVE SCARVES OR OTHER COVERINGS WHICH MIGHT OBSTRUCT VENTILATION.
4. WALL AND SHELF MOUNTED INSTALLATIONS USING A COMMERCIAL MOUNTING KIT. MUST FOLLOW THE FACTORY APPROVED MOUNTING INSTRUCTIONS A PRODUCT MOUNTED TO A SHELF OR PLATFORM MUST RETAIN ITS ORIGINAL FEET (OR THE EQUIVALENT THICKNESS IN SPACERS) TO PROVIDE ADEQUATE AIR FLOW ACROSS THE BOTTOM, BOLTS OR SCREWS USED FOR FASTENERS MUST NOT TOUCH ANY PARTS OR WIRING. PERFORM LEAKAGE TEST ON CUSTOMIZED INSTALLATIONS.
5. CAUTION CUSTOMERS AGAINST THE MOUNTING OF A PRODUCT ON SLOPING SHELF OR A TILTED POSITION, UNLESS THE PRODUCT IS PROPERLY SECURED.
6. A PRODUCT ON A ROLL-ABOUT CART SHOULD BE STABLE ON ITS MOUNTING TO THE CART. CAUTION THE CUSTOMER ON THE HAZARDS OF TRYING TO ROLL A CART WITH SMALL CASTERS ACROSS THRESHOLDS OR DEEP PILE CARPETS.
7. CAUTION CUSTOMERS AGAINST THE USE OF A CART OR STAND WHICH HAS NOT BEEN LISTED BY UNDERWRITERS LABORATORIES, INC. FOR USE WITH THEIR SPECIFIC MODEL OF TELEVISION RECEIVER OR GENERALLY APPROVED FOR USE WITH T.V.'S OF THE SAME OR LARGER SCREEN SIZE.
8. CAUTION CUSTOMERS AGAINST THE USE OF EXTENSION CORDS, EXPLAIN THAT A FOREST OF EXTENSIONS SPROUTING FROM A SINGLE OUTLET CAN LEAD TO DISASTROUS CONSEQUENCES TO HOME AND FAMILY.

SERVICING PRECAUTIONS

CAUTION : Before servicing the VCR+DVD covered by this service data and its supplements and addends, read and follow the **SAFETY PRECAUTIONS**. **NOTE** : if unforeseen circumstances create conflict between the following servicing precautions and any of the safety precautions in this publication, always follow the safety precautions.

Remembers Safety First:

General Servicing Precautions

1. Always unplug the VCR+DVD AC power cord from the AC power source before:
 - (1) Removing or reinstalling any component, circuit board, module, or any other assembly.
 - (2) Disconnection or reconnecting any internal electrical plug or other electrical connection.
 - (3) Connecting a test substitute in parallel with an electrolytic capacitor.
Caution : A wrong part substitution or incorrect polarity installation of electrolytic capacitors may result in an explosion hazard.
2. Do not spray chemicals on or near this VCR+DVD or any of its assemblies.
3. Unless specified otherwise in this service data, clean electrical contacts by applying an appropriate contact cleaning solution to the contacts with a pipe cleaner, cotton-tipped swab, or comparable soft applicator. Unless specified otherwise in this service data, lubrication of contacts is not required.
4. Do not defeat any plug/socket B+ voltage interlocks with which instruments covered by this service manual might be equipped.
5. Do not apply AC power to this VCR+DVD and/or any of its electrical assemblies unless all solid-state device heat sinks are correctly installed.
6. Always connect test instrument ground lead to the appropriate ground before connection the test instrument positive lead. Always remove the test instrument ground lead last.

Insulation Checking Procedure

Disconnect the attachment plug from the AC outlet and turn the power on. Connect an insulation resistance meter(500V) to the blades of the attachment plug. The insulation resistance between each blade of the attachment plug and accessible conductive parts (Note 1) should be more than 1M-ohm.

Note 1 : Accessible Conductive Parts including Metal panels, Input terminals, Earphone jacks, etc.

Electrostatically Sensitive (ES) Devices

Some semiconductor (solid state) devices can be damaged easily by static electricity. Such components commonly are called Electrostatically Sensitive (ES) Devices. Examples of typical ES devices are integrated circuits and some field effect transistors and semiconductor chip components.

The following techniques should be used to help reduce the incidence of component damage caused by static electricity.

1. Immediately before handling any semiconductor component or semiconductor-equipped assembly, drain off any electrostatic charge on your body by touching a known earth ground. Alternatively, obtain and wear a commercially available discharging wrist strap device, which should be removed for potential shock reasons prior to applying power to the unit under test.
2. After removing an electrical assembly equipped with ES devices, place the assembly on a conductive surface such as aluminum foil, to prevent electrostatic charge buildup or exposure of the assembly.
3. Use only a grounded-tip soldering iron to solder or unsolder ES devices.
4. Use only an anti-static solder removal device. Some solder removal devices not classified a "anti-static" can generate electrical charges sufficient to damage ES devices.
5. Do not use freon-propelled chemicals. These can generate electrical charge sufficient to damage ES devices.
6. Do not remove a replacement ES device from its protective package until immediately before you are ready to install it. (Most replacement ES devices are packaged with leads electrically shorted together by conductive foam, aluminum foil, or comparable conductive material).
7. Immediately before removing the protective material from the leads of a replacement ES device, touch the protective material to the chassis or circuit assembly into which the device will be installed.

Caution : Be sure no power is applied to the chassis or circuit, and observe all other safety precautions.

8. Minimize bodily motions when handling unpackaged replacement ES devices. (Normally harmless motion such as the brushing together of your clothes fabric or the lifting of your foot from a carpeted floor can generate static electricity sufficient to damage an ES device.)