

SETUP INSTRUCTIONS AND PRE-OPERATION CHECKLIST FOR SNAPPER GROUNDS CRUISER UTILITY VEHICLE

INTRODUCTION: These instructions cover the setup of the Snapper Grounds Cruiser utility vehicle. Complete each step carefully. A checklist has been provided. It is very important to verify and record each item on the list prior to placing the machine into service. The dry weight of the machine you are about to setup is 1,230 lb. It is strongly recommended that you use an overhead hoist when lifting the machine. The capacity of the device used for lifting must exceed the weight of the machine. **DO NOT** work on the machine until properly blocked and secured to prevent it from falling. If an overhead hoist is not available, you may have to remove boards from the crate bottom to gain access with floor type jacks.

WARNING

DO NOT attempt any adjustments, maintenance or service with the engine running. **STOP** engine. Set park brake. Shift transmission to neutral and remove key. Remove spark plug wire from spark plug and secure wire away from spark plug. Engine and components are **HOT**. Avoid serious burns, allow all parts to cool before working on machine.

STEP 1 INSTALL REAR TIRES

The machine is securely attached to the crate bottom at each wheel location. See Figure 1.1. The four steel plates must be removed before lifting the machine. The device used to lift the machine must have a capacity greater than 1230 lb. The cargo bed is attached to the frame of the machine with plastic straps. Carefully remove the straps and set the cargo bed aside for installation later.

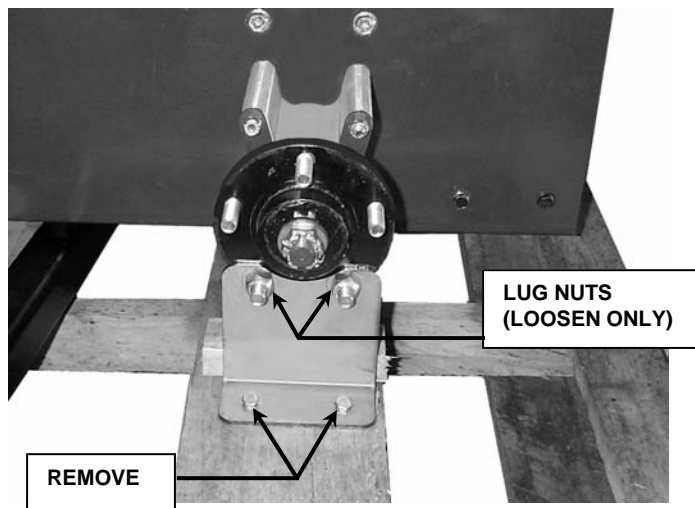

FIGURE 1.1

1. Loosen only, two lug nuts at left and right rear wheel hubs.
2. Remove the four bolts securing the left and right support plates to the crate bottom.
3. Lift machine, at the rear hitch, only high enough to allow tire installation. Block machine securely to prevent it from falling. Remove support plates.
4. Check castle nuts to insure that the cotter pins have been fully inserted and have at least one leg bent to secure in place.

5. Install left and right rear tires and secure each with 5 lug nuts. NOTE: The tires are directional. Install with valve stem out and the points of the chevron treads pointing forward. See Figure 1.2.



FIGURE 1.2

6. Remove blocks and lower rear of machine.
7. Torque lug nuts to 75 ft-lb using sequence shown. See Figure 1.2.

STEP 2 INSTALL FRONT BUMPER

The bolts used to attach the front bumper to the machine are already installed in the front frame. The bumper can be used to lift the weight of the front of the machine. The mounting hardware must be tightened securely (30 ft-lb).

1. Place bumper over four bolts at front of frame. Note orientation, flat side of side plates towards bottom
2. Attach using (4) 3/8-16 flange lock nuts.
3. Torque nuts to 30 ft-lb.

STEP 3 INSTALL FRONT TIRES

The front bumper can be used to lift the front of the machine. Block the machine to prevent it from falling. NOTE: The front tires are directional. Install with valve stems out and with the points of the chevron treads pointing forward.

1. Loosen only, two lug nuts at left and right front wheel hubs.
2. Remove the four bolts securing the left and right support plates to the crate bottom.
3. Lift front of machine only high enough to install front tires. Block machine securely to prevent it from falling. Remove support plates.
4. **REMOVE OPERATOR PROTECTIVE STRUCTURE FROM CRATE BOTTOM AT THIS TIME.**
5. Check front wheel hubs to insure that they rotate freely, the castle nuts are tight and the cotter pins are inserted fully and have at least one leg bent to secure in place.
6. Install left and right front tires and secure each with 5 lug nuts.
7. Remove blocks and lower machine.
8. Torque lug nuts to 75 ft-lb using sequence shown. See Figure 1.2.
9. Install dust caps onto wheel hubs

STEP 4 ADJUST TIRE PRESSURE

IMPORTANT! Correct tire inflation pressure is critical to the proper handling and braking of the machine.

1. Using a low-pressure tire gauge, check tire pressure.
2. Adjust tire pressure to 15 psi.

 WARNING 
Operator Protective Structure and Seat Belts must be installed and all mounting hardware tightened securely before starting or operating machine.

STEP 5 INSTALL SEAT BELTS

Mounting of seat belts is very important. Assemble carefully using the sequence shown. The seat belt with the latch plate is typically attached at the outside mounting hole. The seat belt with the buckle is attached at the inside or middle mounting hole. Tighten hardware to a snug rotating fit as described below.

IMPORTANT! The large 2 1/2" diameter flat washers must be installed on the inside surface of the seat support structure. See Figure 1.3.

1. Remove the top two bolts from the fuel tank straps and slide tank out. This will allow clearance to install the bolt used to mount the right seat belt. See Figure 1.4.

NOTE: tank straps remain loose until STEP 6, Operator Protective Structure installation has been completed.

2. Locate seat belts and hardware bag.

3. Place (1) 1/2" x 1 1/4" diameter flat washer on (1) 7/16-20 x 2" bolt. Insert bolt with washer into seat belt mounting plate. See Figure 1.3.
4. Insert bolt into hole in seat support. Place large 2 1/2" diameter flat washer over bolt against inside surface of seat support.
5. Place (1) 1/2" x 1 1/4" flat washer on bolt. Install (1) 7/16-20 top lock nut.

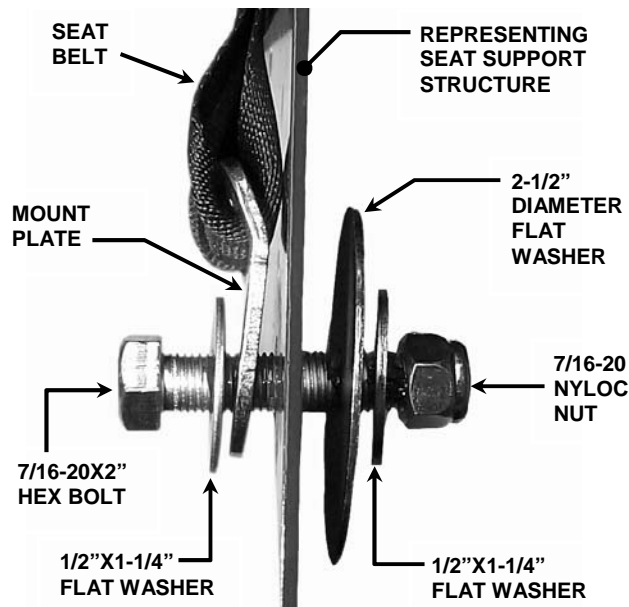



FIGURE 1.3

6. Tighten nut to a snug rotating fit. When properly tightened the mounting bracket should be able to rotate with some resistance to align properly with seat position and size of operator, but not rattle.
7. Repeat for remaining three belts.

 WARNING 
Safe operation of machine limits total occupants to (2), one operator and one passenger. Seat belts must be securely latched and adjusted to a snug fit before starting or operating the machine.

STEP 6 INSTALL OPERATOR PROTECTIVE STRUCTURE (OPS)

The installation of the Operator Protective Structure requires two people. The mounting hardware for the OPS and seat belts must be properly torqued. Do Not modify the OPS in any way. Install the OPS with the "WARNING" sign on the right (passenger's) side of the machine.

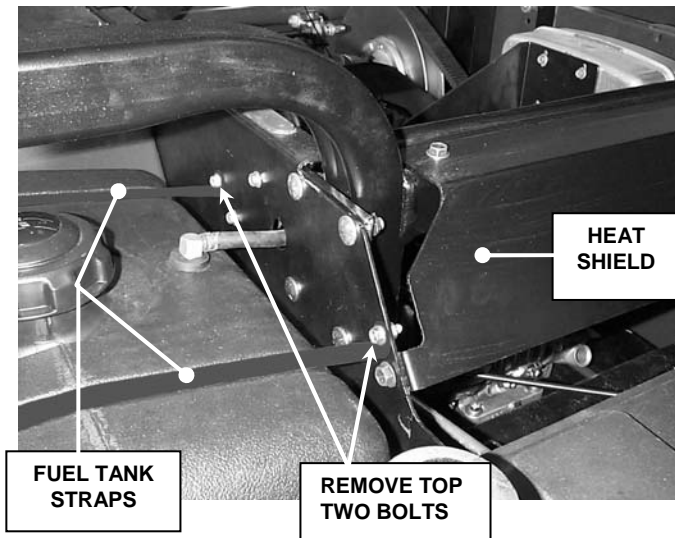

FIGURE 1.4

1. Locate the mounting hardware – (12) 3/8-16 x 1" round head carriage bolts and (12) 3/8-16 Nyloc nuts. Place 6 of each in the left and right seat support tray for easy access when attaching OPS to frame.
2. Raise OPS to vertical position and orientate so that the "WARNING" decal located on the side of the OPS is on the passenger's side of the machine.
3. Align holes in OPS with holes in frame. Get (1) carriage bolt started on each side. NOTE: insert bolts with head towards outside of frame as shown. Secure with 3/8-16 Nyloc nut. Do not tighten at this time.
4. Install remainder of the bolts and secure each with a Nyloc nut.
5. Torque ALL OPS mounting hardware to 30-35 ft-lb.
6. Reattach fuel tank straps. Tighten hardware securely.
7. Attach heat shield to OPS using (2) 5/16-18 self-tapping bolts. Do Not tighten at this time.
8. Attach heat shield to left and right frame rails using (2) 5/16-18 x 7/8" bolts and (2) 5/16-18 NyLoc nuts.
9. Tighten all heat shield hardware securely.
10. Reattach fuel tank straps. Tighten hardware securely.

STEP 7 ENGINE OIL AND TRANSMISSION FLUID

The engine oil and transmission fluid must be checked before operation.

1. Fill engine crankcase to proper level. Refer to Engine Owner's Manual for capacity and oil specifications. Check with dipstick unthreaded.
2. Check transmission fluid level. Bring to full level as necessary using MOBILFLUID 424 or equivalent. Check with dipstick fully threaded.

STEP 8 ACTIVATE BATTERY

Battery is located under the operator's seat. Remove battery from compartment before activating or charging. Activate and charge the battery in well ventilated area away from sparks and flame. Do Not smoke.

1. Remove battery from the battery compartment before charging.
2. Place battery in a well ventilated area on a level non-concrete surface.

⚠ WARNING ⚠

The electrolyte (acid) produces a highly explosive gas. Keep all sparks, flame and fire away from area when charging battery or when handling electrolyte or battery. Electrolyte (acid) is a highly corrosive liquid. Wear eye protection. Wash affected areas immediately after having eye or skin contact with electrolyte (acid). Battery acid is corrosive. Rinse empty acid containers with water and mutilate before discarding. If acid is spilled on battery, bench, or clothing, etc., Flush with clear water and neutralize with baking soda.

3. Remove battery cell caps. Fill cells as required with electrolyte (purchased separately) to proper level. Fill to 3/16" above cell plates. Filling battery with electrolyte will bring the battery to 80% of full charged state.

IMPORTANT: 3/16" above cell plates is the recommended level. Never place anything in battery other than specified electrolyte.

⚠ WARNING ⚠

DO NOT OVERFILL!

4. With cell caps removed, connect battery charger to battery terminals; RED to positive (+) and BLACK to negative (-) terminal.
5. Slow charge the battery at 4 to 6 amps for 2 hours to bring the battery to full charge.
6. After charging, check level of electrolyte and add as needed to bring level to 3/16" above cell plates.
7. Reinstall cell caps. Tighten securely to prevent leakage.

STEP 8 (Continued) ACTIVATE BATTERY

8. Thoroughly clean any spilled acid from battery. Neutralize with Baking Soda and flush with large quantity of water. Dry off battery.
9. Install battery into power unit. Place battery into battery tray and secure in place with retaining rod. See Figure 1.5.

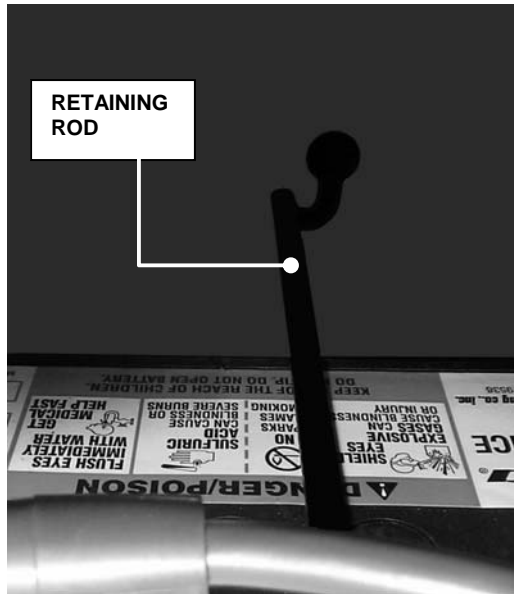

FIGURE 1.5

10. Attach battery cables to terminals on the battery as shown. See Figure 1.6. Connect positive (+) cables (red) first, from wiring harness to the positive terminal (+) on battery and secure with nut provided in hardware bag. Connect negative (-) cables (black) last, to negative terminal (-) on battery and secure. Apply a small amount of grease over terminals to prevent corrosion. See Figure 1.6.

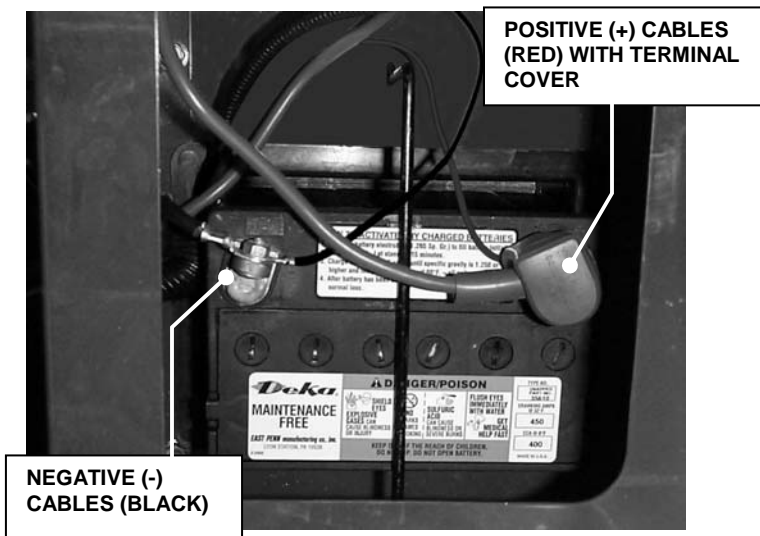

FIGURE 1.6

⚠

WARNING

⚠

Shield the positive terminal with Terminal Cover located on Positive Battery Cable. This prevents metal from touching the positive terminal, which could cause sparks.

STEP 9 INSTALL STEERING WHEEL

Make sure that the front tires are aligned perfectly straight before installing the steering wheel.

1. Make sure that front tires are pointing straight forward.
2. Slide foam cover over steering shaft.
3. Remove plastic cover from center of steering wheel.
4. Orientate the steering wheel so that spokes are horizontal and align splines.
5. Place washer and nut on steering shaft. Torque nut to 50-70 ft-lb.
6. Install plastic cover in center of steering wheel.

STEP 10 INSTALL OPERATOR'S AND PASSENGER'S SEAT

Carefully complete the following steps to install the seats.

1. Check seat bolts to insure hinge plate is tightened securely to the bottom of the seat. See Figure 1.7.
2. Align hinge plate with seat/pedestal assembly and insert hinge rod.

IMPORTANT: Hinge rod must protrude past both sides of the hinge plate and be positively retained by the hair pin.

3. Insert hair pin fully into hinge rod. Hairpin must be between hinge plate and seat/pedestal to retain rod properly. See Figure 1.7.
4. Check for 5/16" flat washer under head of seat knobs. Install washer, if missing, and tighten knobs securely.

STEP 10 (Continued)
INSTALL OPERATOR'S AND PASSENGER'S SEAT

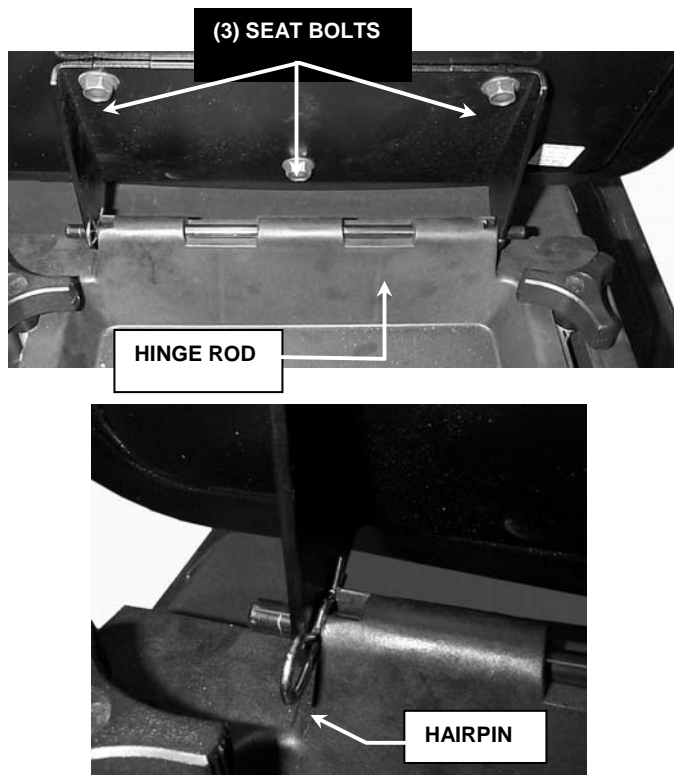

FIGURE 1.7

STEP 11
ATTACH CARGO BED

Attach bed to pivots at rear of frame. A prop rod is provided to support an empty cargo bed only in a raised position.

1. Align brackets on bottom rear of cargo bed with left and right pivots located at rear of frame. See Figure 1.8.
2. Insert (1) 1/2-13 x 3 3/4" bolt into each left and right pivot and secure with 1/2-13 NyLoc nuts. Tighten securely.
3. Attach prop rod to bracket on bottom of cargo bed using (1) 1/2-13 x 3" bolt and (1) 1/2-13 NyLoc nut. Tighten to a snug rotating fit.



FIGURE 1.8

STEP 12
ALIGN CARGO BED LATCH

Lower the Cargo bed slowly until the latch contacts the striker pin. The head of the striker pin should be inside of the latch as shown in figure 1.9. If it is not aligned correctly, loosen the bolts that attach the left and right bed pivot brackets. Then, position the latch over the striker pin as shown in figure 1.9 and re-tighten the bed pivot bracket bolts.

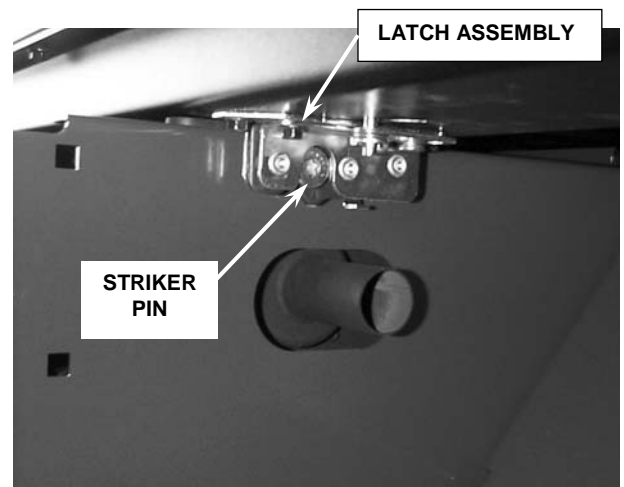

FIGURE 1.9

PRE-OPERATION CHECKLIST FOR SNAPPER GROUNDS CRUISER

Snapper has completed initial adjustments and performed operational tests prior to shipping the machine. Due to the possible effects of shipping, handling and storage, Snapper intends for all of the following items to be verified and necessary final adjustments made at time of setup. It remains good practice and is strongly recommended that all the items also be checked prior to placing the machine into service. It is very important that setup is verified and all operational tests completed and results are acceptable. After completing this form, sign and retain for future reference.

SET-UP

- _____ GENERAL INSPECTION for loose, missing or damaged components. Repaired as necessary.
- _____ WHEEL LUG NUTS checked and torqued to 75 ft-lb.
- _____ FRONT & REAR AXLE NUTS checked, castle nuts installed and secured with cotter pins.
- _____ TIRE PRESSURE, FRONT AND REAR, adjusted to 15 PSI.
- _____ SEAT BELTS installed, hardware tightened, and function of buckles verified.
- _____ OPERATOR PROTECTIVE STRUCTURE installed and hardware torqued to 50-70 ft-lb.
- _____ BATTERY activated, charged and installed properly.
- _____ STEERING WHEEL installed, alignment checked and nut torqued to 50-70 ft-lb.
- _____ CARGO BED AND PROP ROD installed and hardware tightened according to instructions.
- _____ CARGO BED LATCH function verified.
- _____ OPERATOR CONTROLS checked for binding and damage.

LUBRICATION AND FUEL

- _____ ENGINE OIL added to bring level up to full mark (Refer to Engine Manual).
- _____ TRANSMISSION FLUID checked and adjusted to full mark. (MOBILFLUID 424)
- _____ AXLE COUPLINGS AND STEERING KING PINS greased. (Refer to Operator's manual).
- _____ FUEL added to tank and system checked for leaks. (Refer to Engine Manual for fuel specifications).

OPERATIONAL TEST

- _____ ENGINE started, engine idles without dieing and runs smoothly.
- _____ SAFETY INTERLOCKS checked and all function correctly. (Refer to Operator's manual).
- _____ TRANSMISSION shifts into forward and reverse without excessive grinding of gears.
- _____ CLUTCH engages and accelerates smoothly and does not drag at idle.
- _____ STEERING checked and functions properly.
- _____ SERVICE BRAKE AND PARK BRAKE checked and both function properly. (Refer to Operator's manual).

CONSUMER INFORMATION

Purchase Date _____ Model _____ Serial No. _____

Retailer's Name _____ Signature _____

Address _____ City _____ State _____ Zip _____

MACHINE WILL BE USED COMMERCIALY? _ YES _____ NO

Purchaser's Name _____ Signature _____

Address _____ City _____ State _____ Zip _____

IMPORTANT: This form is to be retained for future reference regarding Warranty, proof of purchase, traceability for product recall or service, etc. Complete the Product Registration Card and Mail to Customer Service Department at SNAPPER, P.O. BOX 1379, McDonough, Georgia, 30253.