

OWNER'S MANUAL

Palsonic

51CM CORDLESS REMOTE COLOUR TELEVISION
MODEL: 5130G



Type Tested
Electrical
Safety

AS/NZS 3250 Lic 4164
Standards Australia
APP No: N15959

PALSONIC CORPORATION PTY LTD
1 JOYNTON AVENUE
WATERLOO NSW 2017 AUSTRALIA
TEL: (02) 9313 7111
FAX: (02) 9313 7555
www.palsonic.com.au

**PALSONIC CUSTOMER SERVICE
TELEPHONE
AUSTRALIA: 1300 657 888**

Contents

Congratulations on your purchase of this **Palsonic** colour television receiver. We recommend that you thoroughly read this manual before use to fully enjoy the many functions and excellent effects of this receiver.

Retain this manual in an easily accessible location for future reference.

Note: Screen displays and illustrations in this manual may differ from the actual ones for better visibility.

CONTENTS

Features	1
Important Safety Cautions	2
Identification of Controls	4
Installation	8
Menu Introduction	10
Turning On/Off	12
Select Input Signal	13
Tuning In	14
Channel Selection	17
Adjusting Picture	18
Sound Control	19
Clock Setting.....	20
System Setting.....	22
Safe Mode	24
Troubleshooting Guide	27
Specifications	28

- ▶ **Hyperband**
- ▶ **Intellectualised I²C bus control**
- ▶ **255 preset channels**
- ▶ **Automatic channel preset**
- ▶ **Full function remote control**
- ▶ **AV input and output terminals**
- ▶ **Clock/Game/Calendar**
- ▶ **Digital AFT technology**
- ▶ **Four picture modes**
- ▶ **ON timer/OFF timer**
- ▶ **Channel exchange**
- ▶ **Safe mode**

Important Safety Cautions

1

When any unusual situation occurs, turn off the power supply at once and remove the plug from the wall outlet. Contact a qualified service department in your local area.

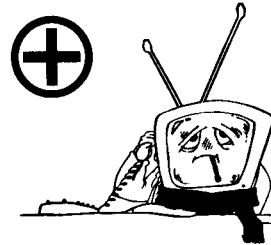

2

Do not expose the TV set to rain or excessive moisture. Avoid using the set in very warm or damp places and never use it in a bathroom.

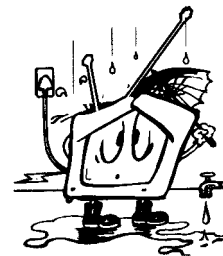

3

When cleaning dust off the picture tube disconnect the power first. You can wipe lightly with a piece of dry, clean and soft cloth.

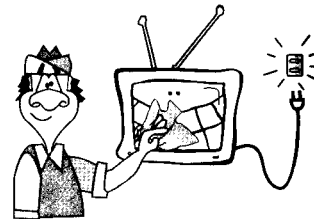

4

Avoid exposing the set to direct sunlight and other sources of heat to prevent damage to the cabinet and components.

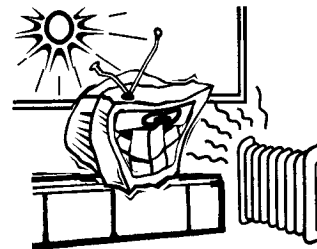

5

High voltage exists in this TV set. Do not remove the cover.

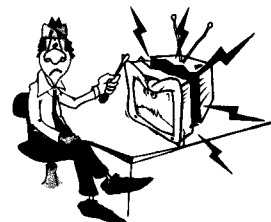

! This TV set can operate on an AC power of 240V, 50Hz. You must not use a power supply of any other type.

6 Do not cover the ventilating hole in the cabinet
Keep a space of more than 5 cm from the walls to the TV set to ensure adequate ventilation.

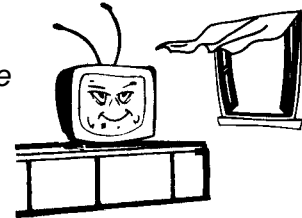

7 If the power cord or the plug is damaged contact a qualified service department for service.

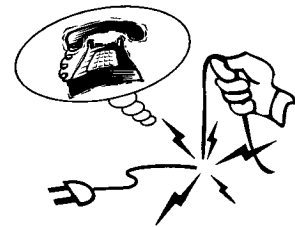

8 When the TV set is to be left unattended for a long period of time, turn off the power supply and remove the plug from the wall outlet.

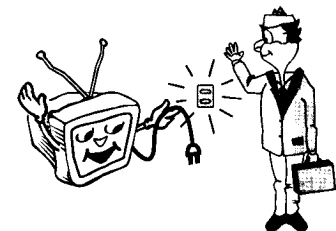

9 Don't try to push anything into the cabinet or place any vessel with water on the set.

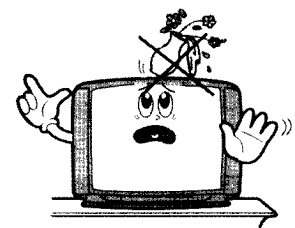

10 Don't overload wall outlets; extension cords, or integral convenience receptacles as this can result in a risk of fire or electric shock.

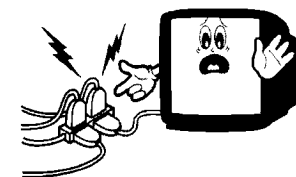

Identification of Controls

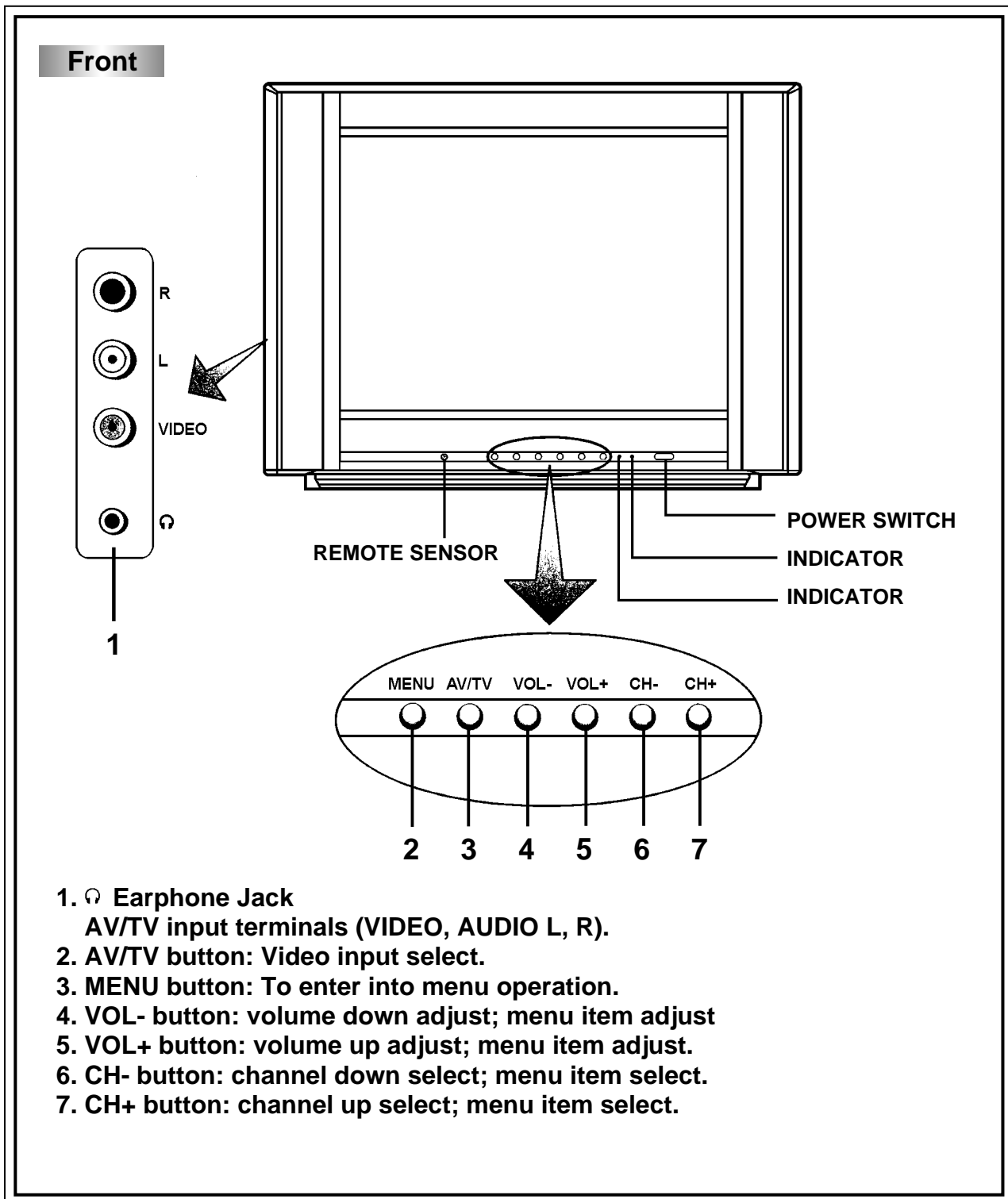

Back

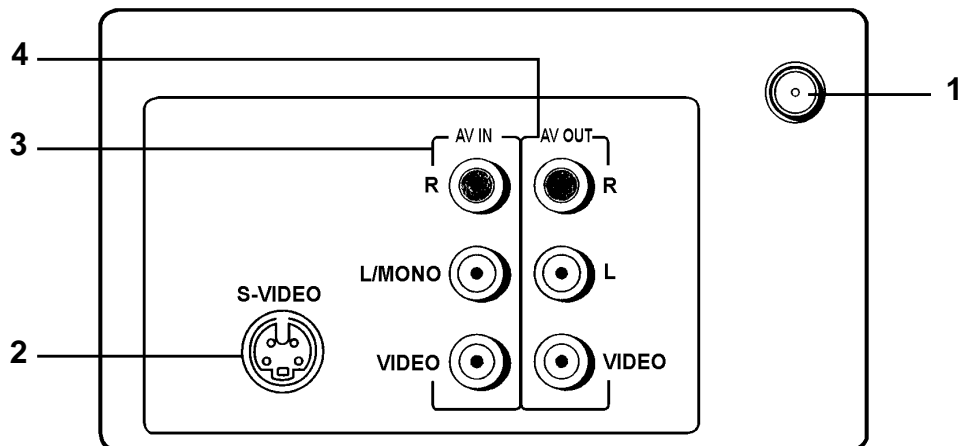
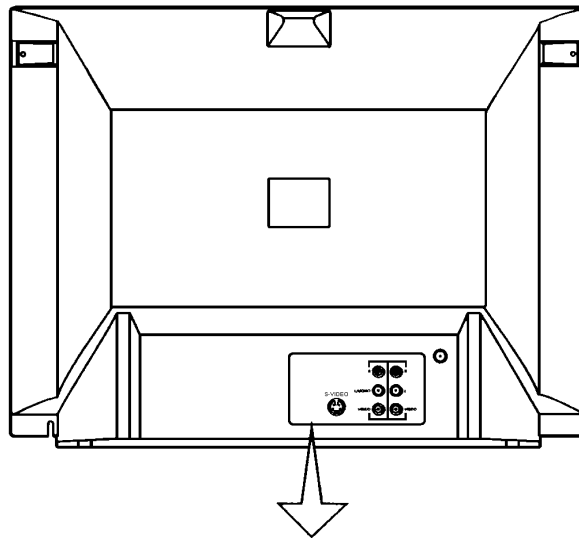

- 1. Antenna input
- 2. S-VIDEO input
- 3. AV input (VIDEO, AUDIO L/MONO, R)
- 4. AV output (VIDEO, AUDIO L/MONO, R)

Identification of Controls (continued)

Remote Controller

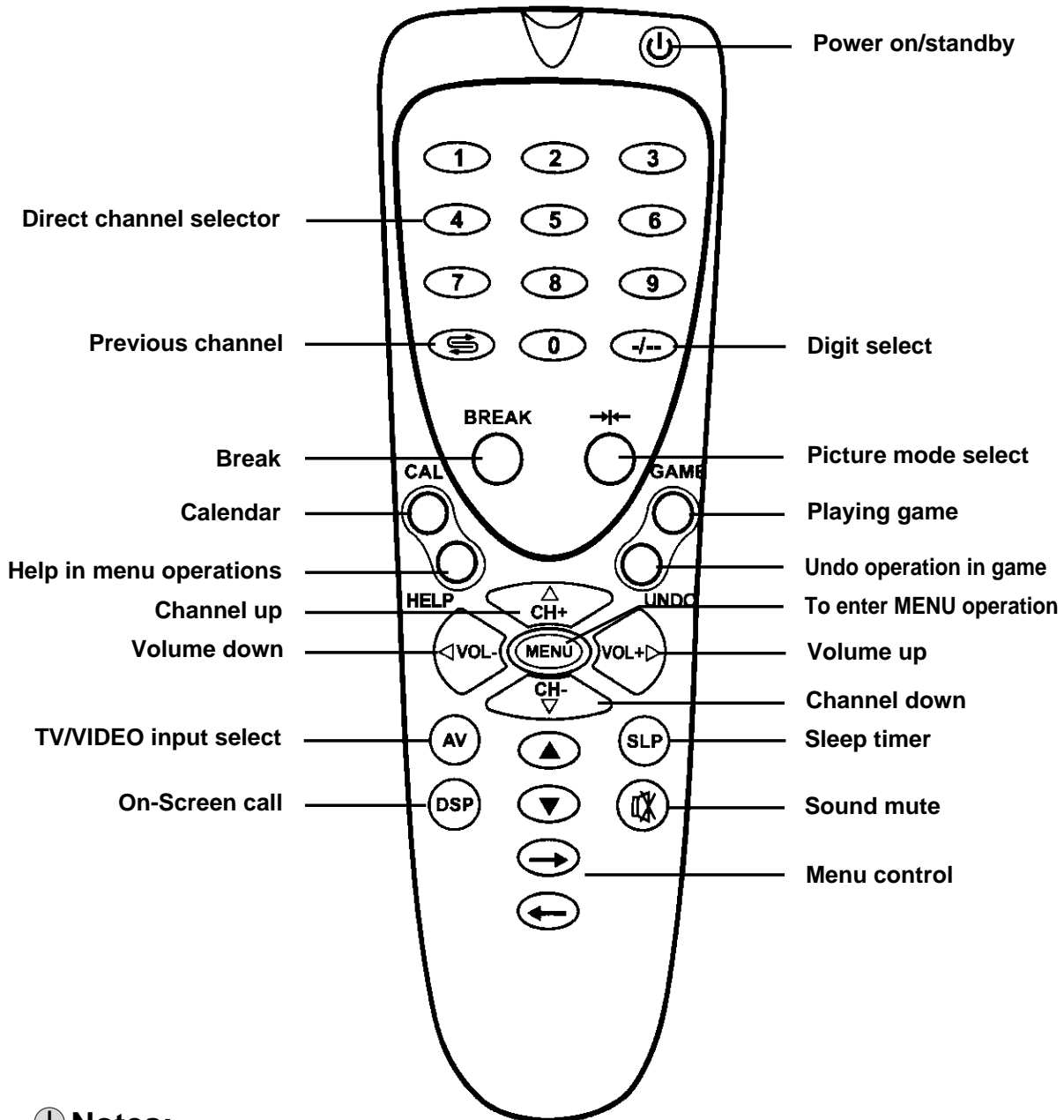

! Notes:

In most cases, the function CH+/- buttons are equal to the ▲/▼ buttons, and the function of VOL+/- buttons are equal to the →/← buttons.

Installing batteries

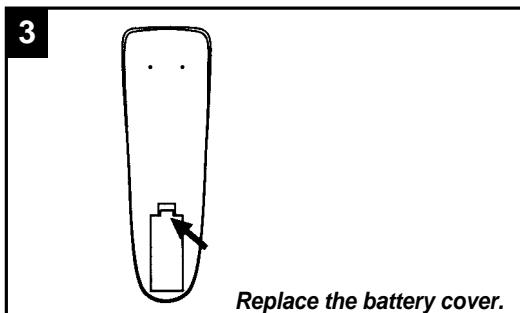
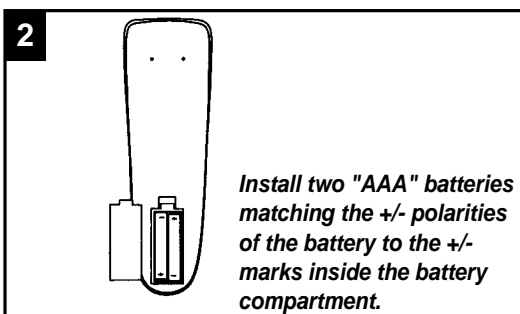
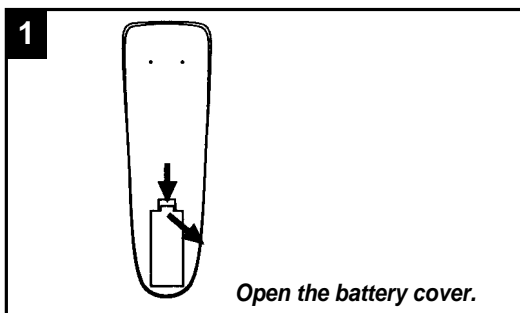

! Notes:

- ❑ The battery life should be about one year under normal use. Do not try to recharge batteries not intended to be recharged.
- ❑ Use only the size and type of batteries specified. Do not mix different types of batteries together or old batteries with fresh ones.
- ❑ When the remote control will not be used for a long period of time or when the batteries are worn out, remove the batteries.
- ❑ Do not throw the batteries into a fire. Dispose of used batteries in the specified manner.
- ❑ Do not drop, dampen or disassemble the remote control.

Effective range of the Remote

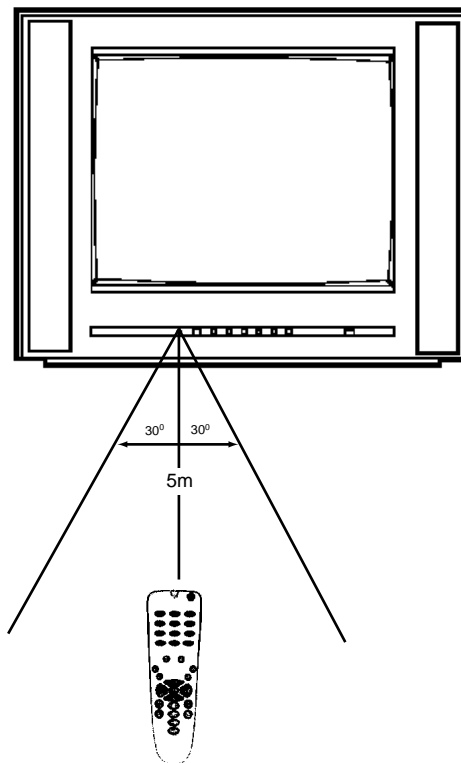

! Notes:

- ❑ When there is an obstacle between the TV and the transmitter, the transmitter may not operate.
- ❑ When direct sunlight, and incandescent lamp, fluorescent lamp or any other strong light shines on the REMOTE SENSOR of the TV the remote operation may be unstable.

Installation

INSTALL the unit in a room where direct light will not fall upon the screen. Total darkness or a reflection on the picture screen may cause eyestrain. Soft and indirect lighting is recommended for comfortable viewing.

Antenna installation

Optimum reception of colour requires a good signal and will generally mean that an outdoor aerial must be used. The exact type and position of the aerial will depend upon your particular area.

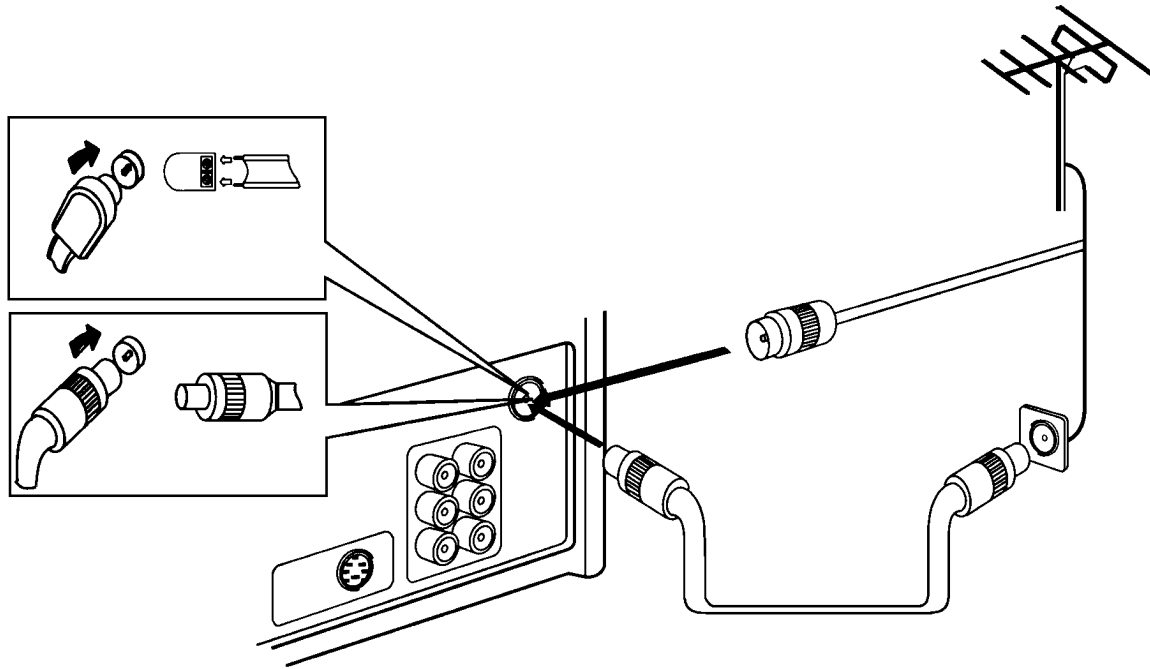

! Notes:

- It is recommended that the 75-ohm coaxial cable be used to eliminate interference and noise which may occur due to radio wave conditions.
- The aerial cable should not be bundled with the power cord and the like.

Connect to video and audio equipment

This TV set provides AV input terminals for your convenient connection to VTR, DVD or video camera to enjoy the high quality picture.

Please refer to the owner's manual of the equipment to be connected as well.

Important notes on the AV input terminals

Please do not connect and use the side and rear input terminals at the same time.

You can connect a stereo system to the AV output terminals on the set to enjoy a high quality sound from the stereo system. The AV output terminals output video and audio signals being displayed on the screen.

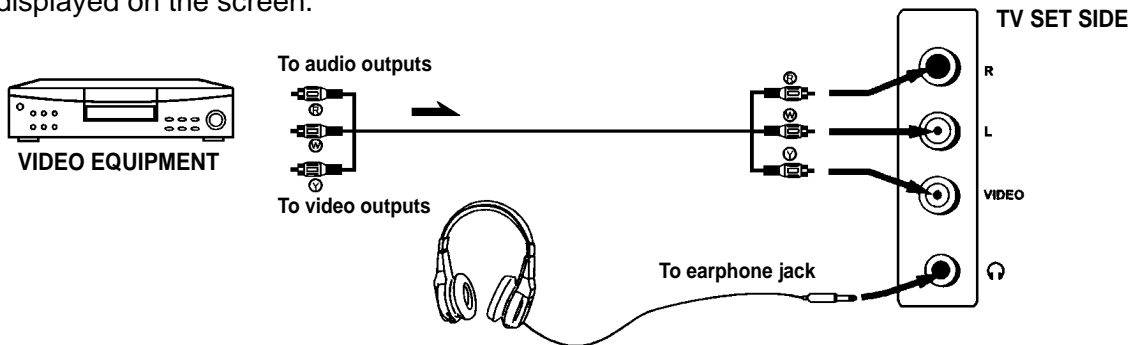

You can also use the AV terminals on the TV set rear as follows.

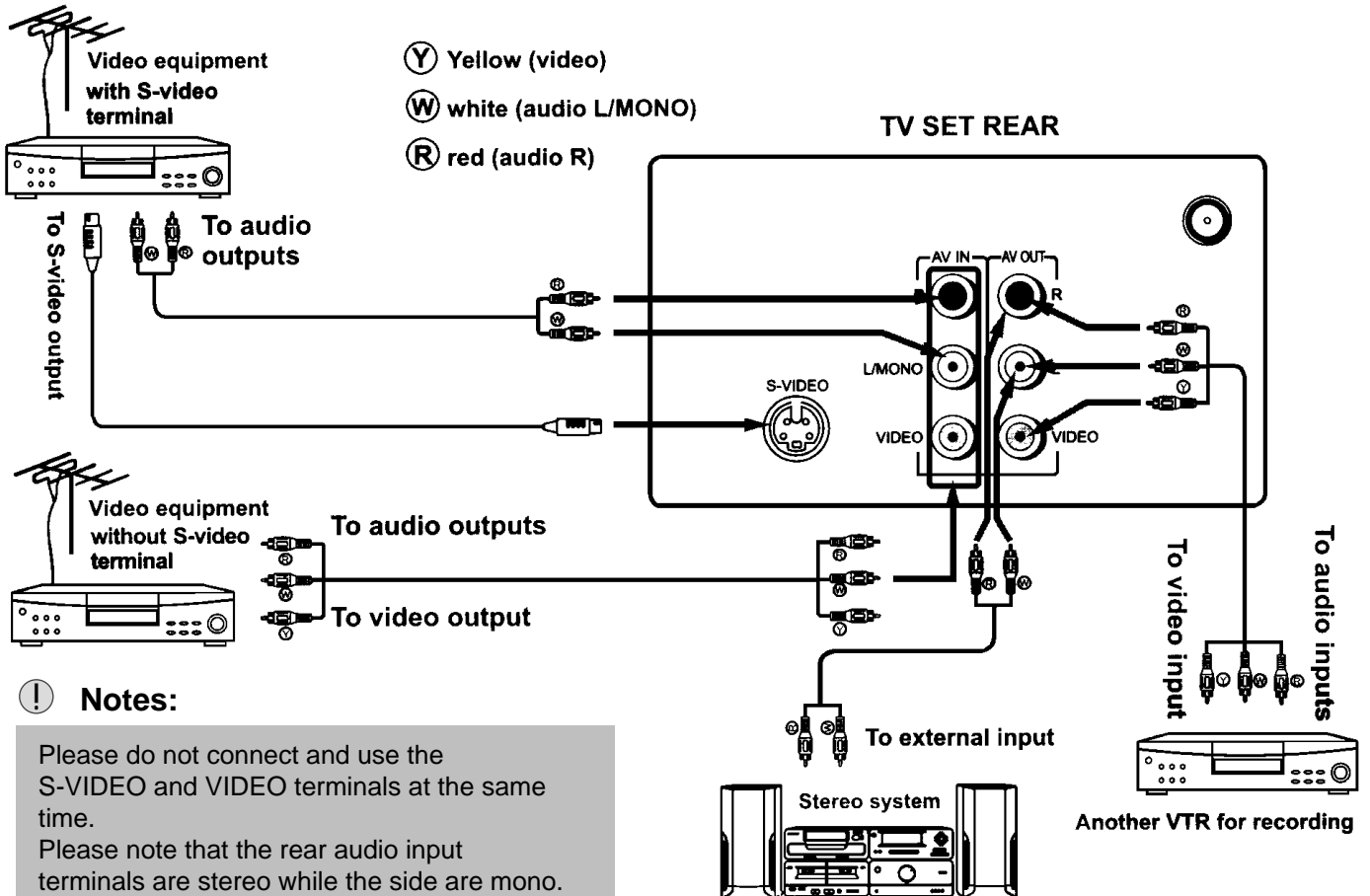

Menu Introduction

In **MENU** operations, the **CH+/-** (or **▲/▼**) buttons are used to select item upwards or downwards; the **VOL+/-** (or **→/←**) buttons are used to adjust or confirm selected item.

Join to page 11 →

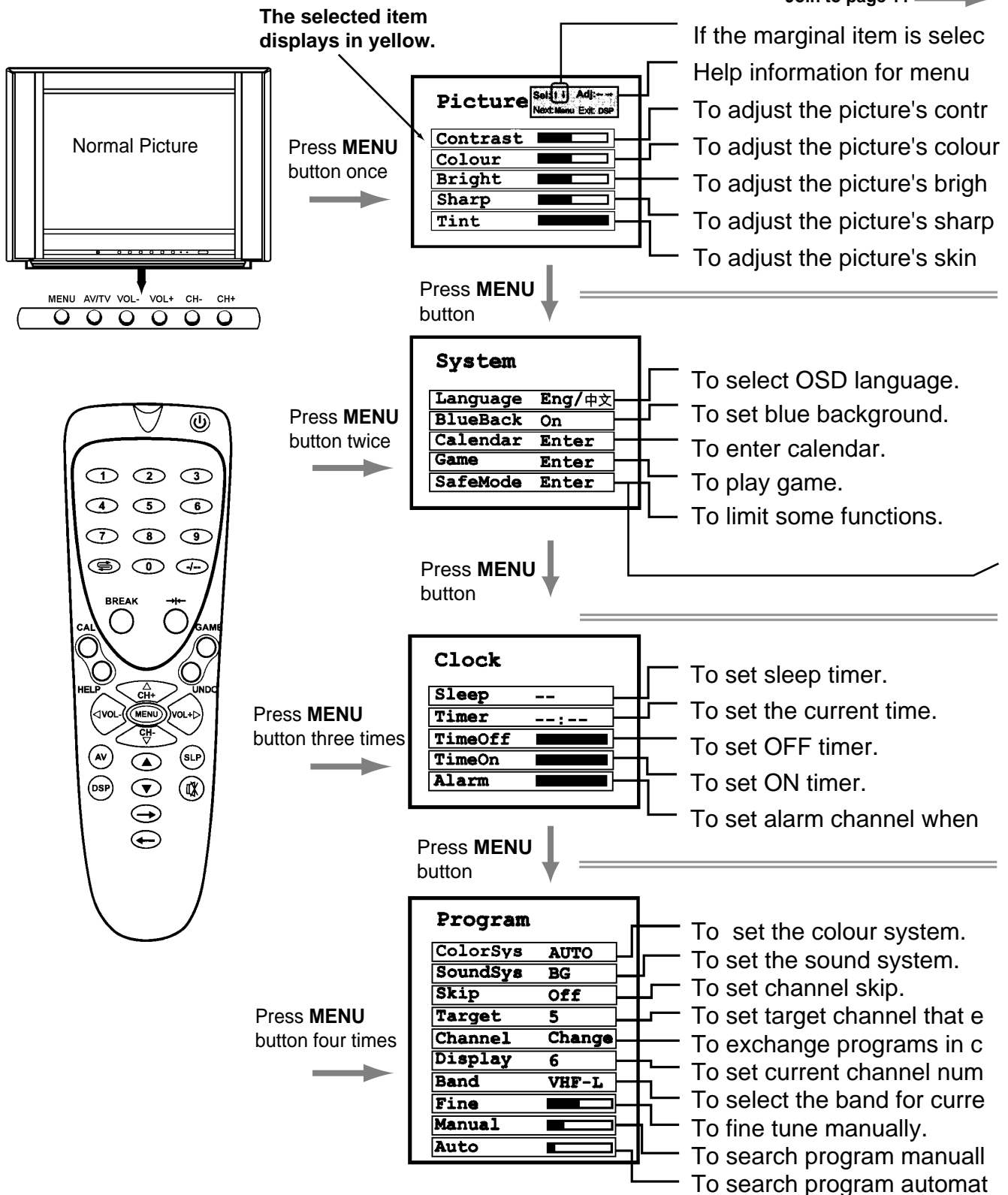

⚠ **Notes:**

In most cases, the function of CH+/- buttons are equal to the ▲/▼ buttons; and the function of VOL+/- buttons are equal to the →/← buttons.

← Join to page 10

ted and there are some items that are not displayed yet, the ↑ or ↓ symbol twinkles. operations (Press **HELP** button to display/cancel this help bar).

ast.

tness.

ness.

colour. (This item is available only in NTSC)

⚠ The **Picture** menu will be shielded if you set the **AdjLimit** item to **Off** in **SafeMode**.

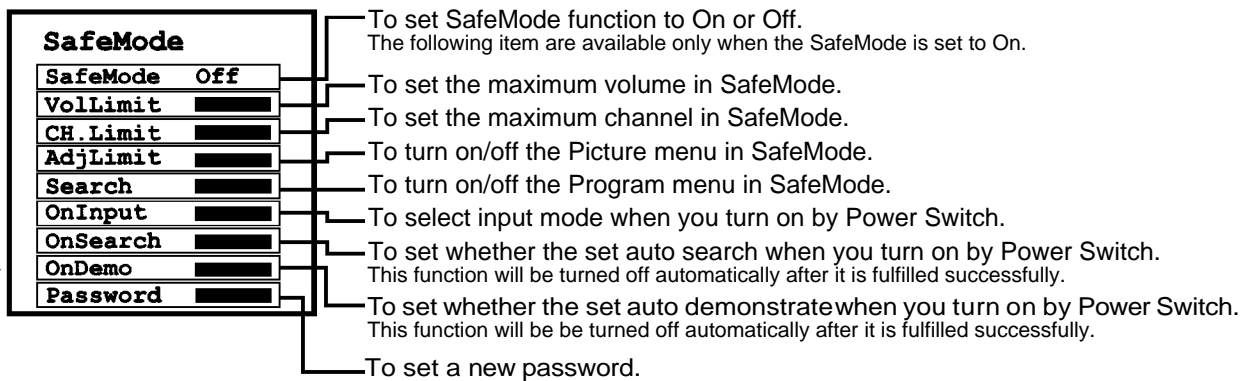

the T V set auto turns on by TimeOn function.

⚠ The **Program** menu will be shielded if you set the **Search** item to **Off** in **SafeMode**.

changes its program with current channel's program.

urrent channel and target channel.

ber.

nt channel.

y, it stops if a certain program is found.

ically.

← Join to page 10

Turning on/off

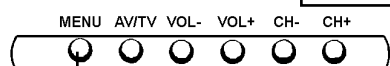
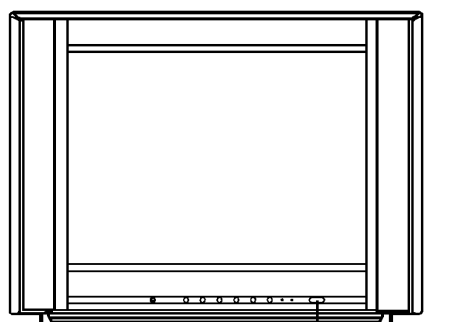

3

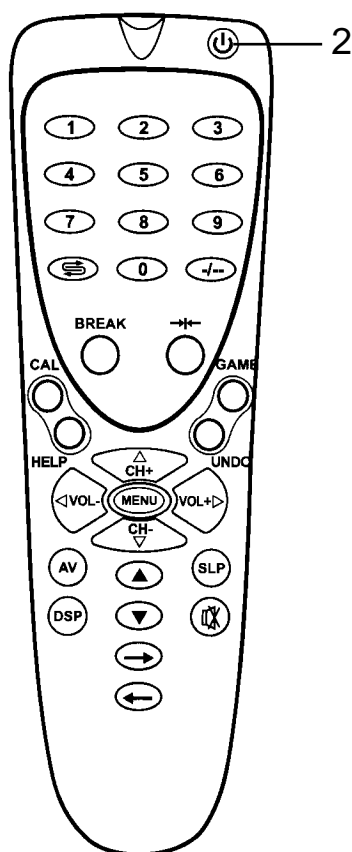

2

Turning on

1. Press the Power Switch on the TV set.
If no picture appears, then the TV set is in STANDBY mode. Now please follow step 2.
2. In **STANDBY** mode, press the  button on the remote controller and the TV set is turned on.
3. In **STANDBY** mode, you can also press the **AV/TV** button on the set to turn on.

! Notes:

If there is no input signal, then a blueground appears. After 15 minutes, the set auto goes to STANDBY.

Turning off

1. Press the **Power Switch** on the TV set if you want to cut off the power completely.
2. If you want to turn off the TV set temporarily, press the  button on the remote controller.

! Notes:

There are three kinds of Auto-Power-Off function:

- A. When there is no input signal for 15 minutes.
- B. Sleep-timer function.
- C. Off-timer function.

However, in the mode of Game or Break, the function of Auto-Power-Off if no signal is received will be ineffective.

Select Input Signal

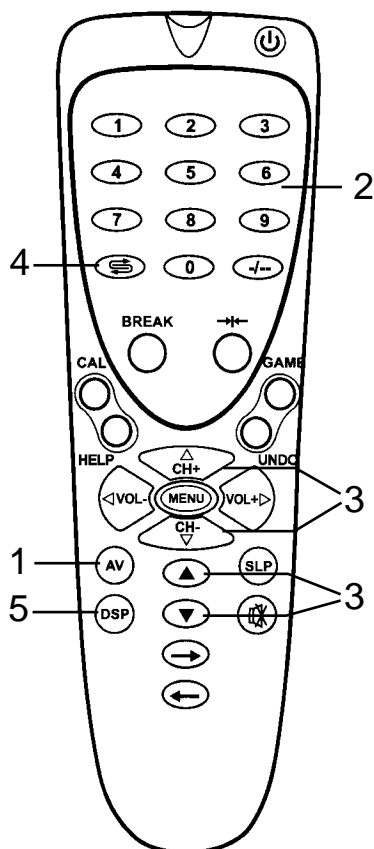
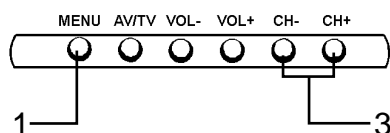
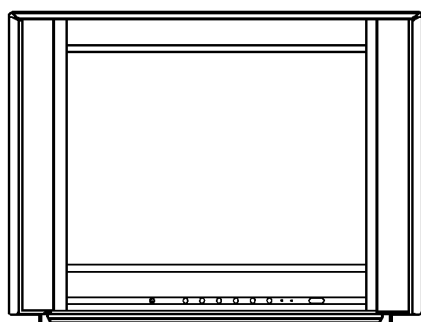

Select input signal

1. Press **AV/TV** button on the TV set or **AV** button on the remote control.

When the set is in TV mode, press this button and the set goes to AV mode. Now you could watch video program from AV input terminals.

If you want to switch to TV press AV button again or follow step 2, 3 or 4.

2. Press the **digit buttons** to switch back to TV mode.
3. Press **CH+** or **CH-** button to switch back to TV mode.
4. Press **≡** button to switch back to TV mode.

5. Press **DSP** button, the set displays current input mode.

The OSD disappears in about 5 seconds.

SafeMode	18:09	18
----------	-------	----

Notes:

If the **Timer** item has been set, the current time also appears.

If the **SafeMode** is turned on, the "**SafeMode**" also appears.

Tuning in

1. Press **MENU** button four times to display **Program** menu.
2. Press **CH+/-** button to **select** item.
3. Press **VOL+/-** button to **confirm** or **adjust** the selected item.

Auto Search

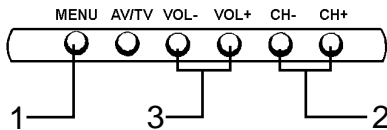
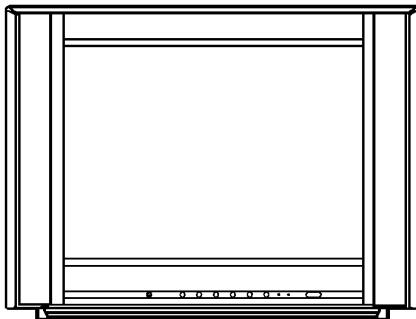

Enter the **Program** menu and select **Auto** item.
 Press **VOL+** or **VOL-** button and the TV set starts Auto Channel Preset. All Active channels will be preset and stored into the memory automatically. After presetting, the TV will stop at the last channel program. During the process of Auto channel preset, pressing the **MENU** or **CH+/-** button will stop the process.

Program	
Display	9
Band	VHF-L
Fine	<input type="checkbox"/>
Manual	<input type="checkbox"/>
▶Auto	<input checked="" type="checkbox"/>

Note:

Before you start Auto Search, we strongly recommend you to set a proper Sound System according to your local area. Please refer to the steps of Sound System setting on page 16.

Manual Search

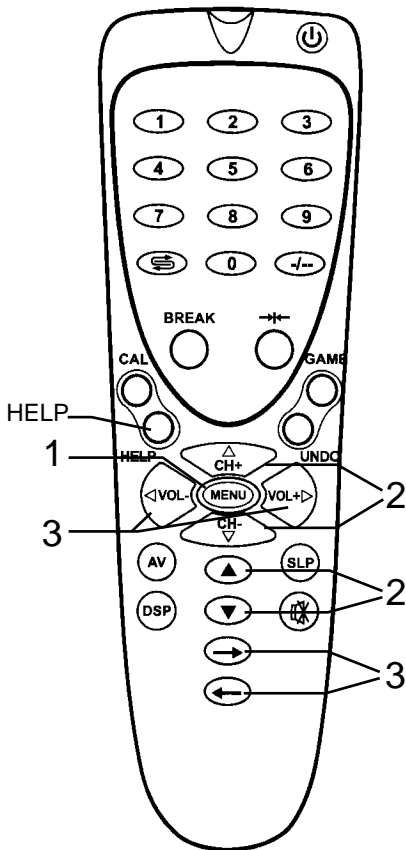

Use manual search function if desired channels cannot be preset or if you would like to preset channels to specific position numbers one by one. Please Select a channel number with **digital buttons** or **CH+/-** buttons. You can also enter program menu, select **Display** item and adjust with **VOL+/-** button manually to select the desired channel number (from 0~254).

Program	
Display	9
Band	VHF-L
Fine	<input type="checkbox"/>
▶Manual	<input checked="" type="checkbox"/>
Auto	<input type="checkbox"/>

In **Program** menu, please select **Manual** item and start manual search with **VOL+/-** buttons. Pressing **VOL+**, the set searches towards higher frequency; Pressing **VOL-**, the set searches towards lower frequency. The search stops when a program is found and the is program will be stored in the specified position number.

You can use **Band** selection to quicken search process if you know which band your desired program is located in. The band switches among **VHF-L**, **VHF-H** and **UHF**. Repeat the above steps if you want to store another program in other position number.

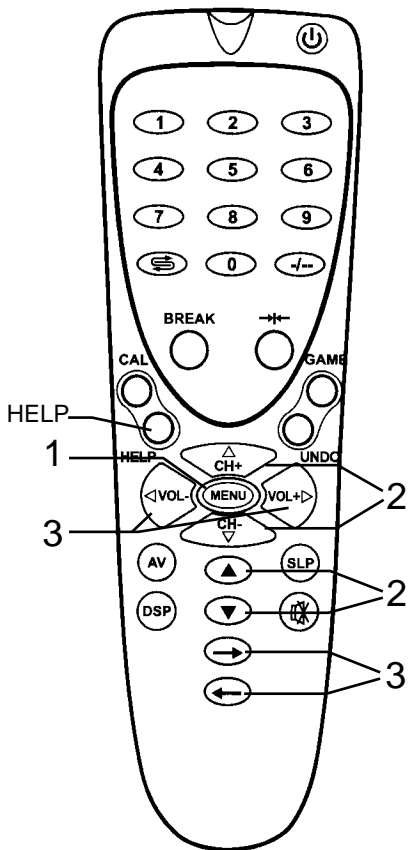
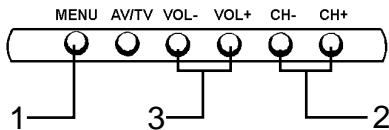
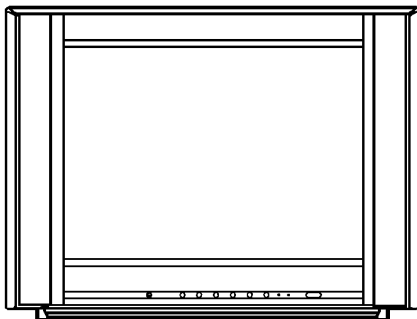

Channel Skipping

You can skip unnecessary channels by using Skip function when you browse by **CH+/-** buttons.

Please select a channel number with digit buttons or **CH+/-** buttons. You can also enter program menu, select **Display** item and adjust with **VOL+/-** buttons manually to select the desired channel number (from 0~254). For example channel 9.

Program	
ColorSys	AUTO
SoundSys	BG
▶ Skip	On
Target	5
Channel	Change

In **Program** menu, please select Skip item and press VOL+ or VOL- button to select **On**.

Now channel 9 will be skipped when you browse channel by **CH+/-** buttons.

To restore a skipped channel, please exit menu first and use **digit buttons** to select the skipped channel number you want to restore. Then enter the **Program** menu, select **Skip** item and set this item to **Off**.

Fine tuning

Fine tuning is not necessary under normal conditions. However, in area of inferior broadcast conditions where adjustment is necessary for a better picture and sound, use Fine tuning.

Please select a channel number with digit buttons or **CH+/-** buttons. You can also enter program menu, select **Display** item and adjust with **VOL+/-** buttons manually to select the desired channel number (from 0~254).

Program	
Display	9
Band	VHF-L
▶ Fine	<input type="checkbox"/>
Manual	<input type="checkbox"/>
Auto	<input type="checkbox"/>

In Program menu, please select Fine item and adjust with VOL+ or VOL- buttons until the best picture and sound are obtained.

Tuning in (continued)

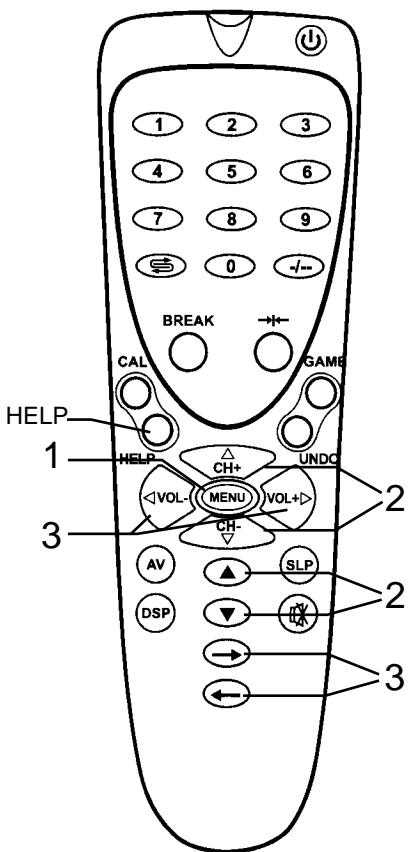
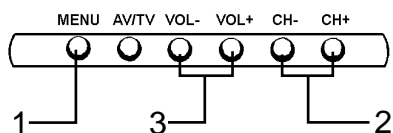
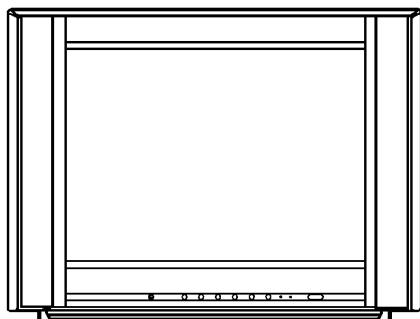

Channel exchange

When auto channel preset is finished, you can edit the order of programs by using the channel exchange function.

Please enter Program menu and select **Target** item. Press **VOL+** or **VOL-** button to select a target channel number that you would like to exchange with the current channel. Then select **Channel Change** item and confirm with **VOL+/-** buttons.

Now the programs in the current channel and target channel will exchange.

You can select the current channel in the **Program** menu by adjusting **Display** item.

Program	
ColorSys	AUTO
SoundSys	BG
Skip	Off
Target	5
▶ Channel	Change

Program	
▶ Display	9
Band	VHF-L
Fine	<input type="checkbox"/>
Manual	<input type="checkbox"/>
Auto	<input type="checkbox"/>

Setting colour system

If the picture colour is abnormal, maybe the colour system setting is wrong. Then you can adjust colour system as follows.

Please enter Program menu and select **ColorSys** item, then press **VOL+** or **VOL-** button to select a proper colour system.

Program	
▶ ColorSys	AUTO
SoundSys	BG
Skip	Off
Target	5
Channel	Change

Setting sound system

If the sound is abnormal, maybe the sound system setting is wrong. Then you can adjust sound system as follows.

Please enter Program menu and select **SoundSys** item, then press **VOL+** or **VOL-** button to select a proper sound system.

Note:
Some models are only with one sound system and in this case the sound system does not need to be adjusted.

Program	
ColorSys	AUTO
▶ SoundSys	BG
Skip	Off
Target	5
Channel	Change

Channel Selection

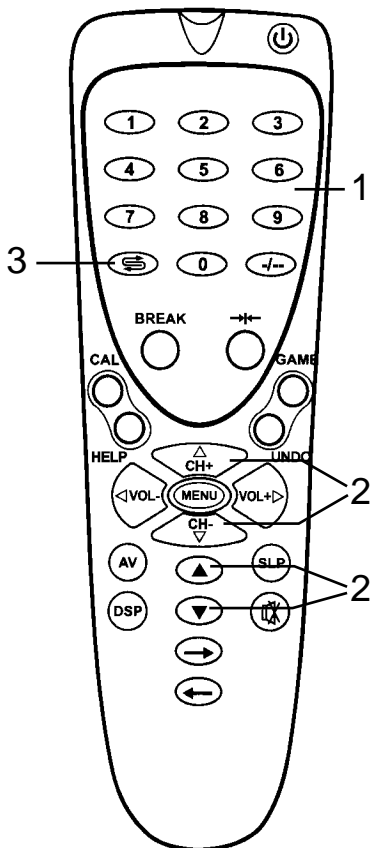
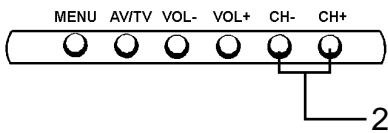
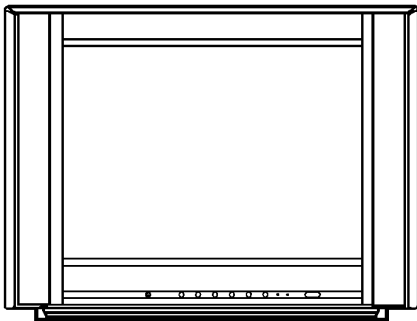

1. Use Direct Channel Selector (0-9 and -/-- buttons)

To select one-digit channel:

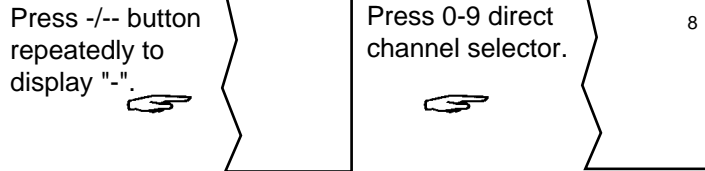

To select two-digit channel:

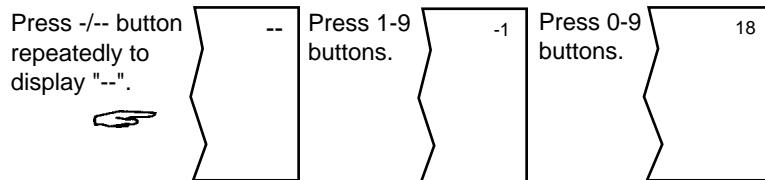

To select three-digit channel:

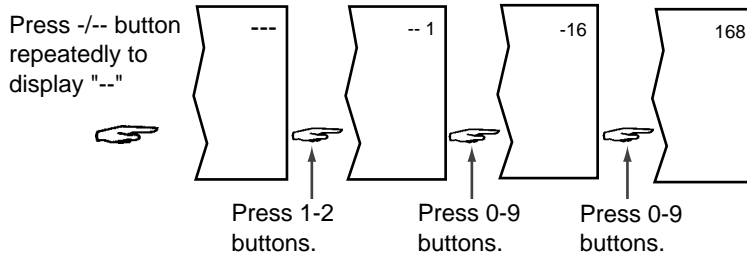

Notes:

The maximum channel number is 254, the set does not act if the channel number you input is out of the range of 0-254 or the number you input is out of the range which is limited in **SafeMode**.

2. Use CH+ or CH- button

Press **CH+** button, the channel number increases;
Press **CH-** button, the channel number decreases.

3. Use previous channel button

Press this button to switch between the current channel and previous channel.

Adjusting Picture

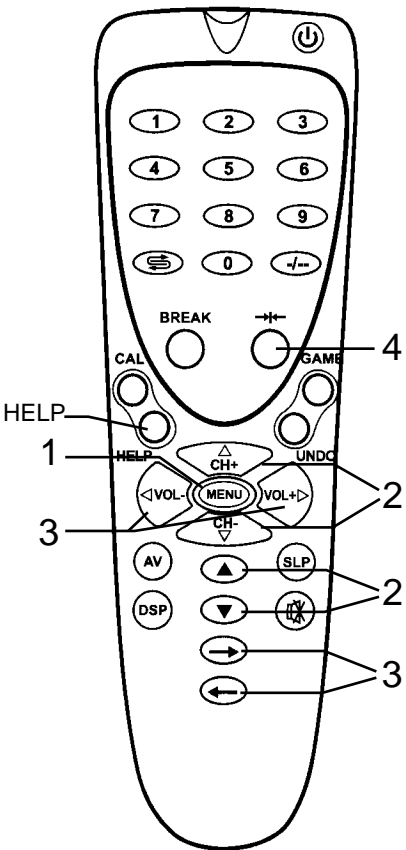
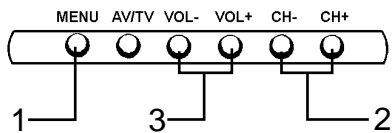
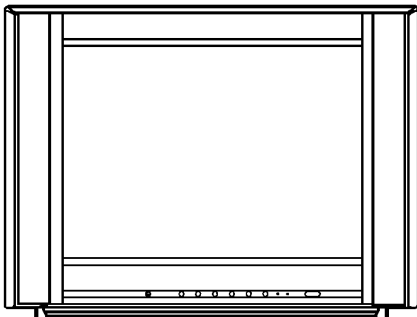

1. Press **MENU** button to display **Picture** menu.
2. Press **CH+/-** button to **select** item.
3. Press **VOL+/-** button to **adjust** the selected item.

Item	VOL-	VOL+
Contrast	weaker	stronger
Color	paler	deeper
Brightness	darker	lighter
Sharpness	softer	sharper
Tint*	purplish	greenish

* Note: The item **TINT** is for NTSC only.

The adjusted settings are stored in the **Personal** mode. There are three preset picture modes and one User-set picture mode. Press the →|← button to select a picture mode according to your favourites.

4. Press →|← button to select picture mode.

Item	Picture mode		
	Standard	Dynamic	Softness
Contrast	80	100	50
Color	50	80	50
Brightness	50	100	30
Sharpness	50	50	50
Tint*	50	50	50

Note: The above parameters maybe different in different models.

Sound Control

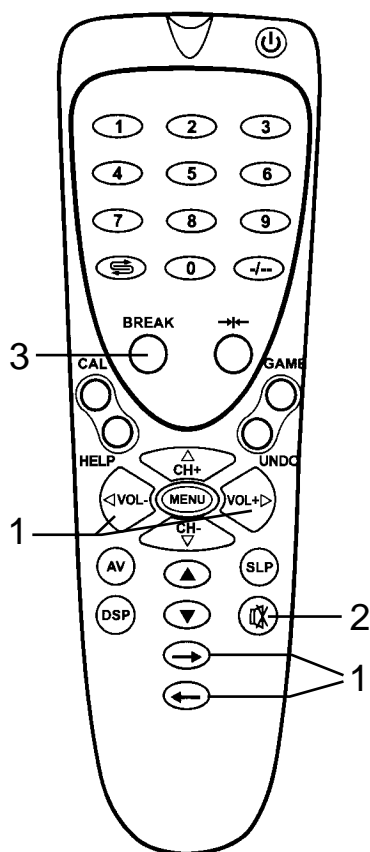
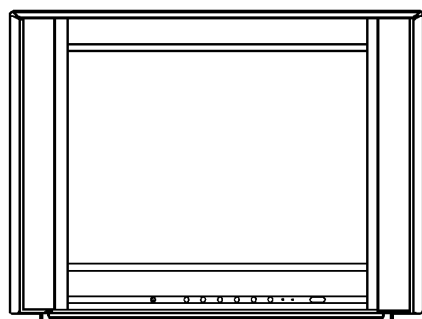

1. Use VOL+ or VOL- button.

Press VOL+ button, the volume increases;
Press VOL- button, the volume decreases.

2. Use MUTE button.

Press **MUTE** button, and the volume decreases to half of the original volume before you adjust.

This mode is useful when many people are watching TV and one of them is going to answer a telephone call.

Press **MUTE** button again to mute the sound completely.

In this mode, you can resume the sound of half of the original volume by pressing **VOL+/-** buttons.

Press **MUTE** button once again to resume the sound completely.

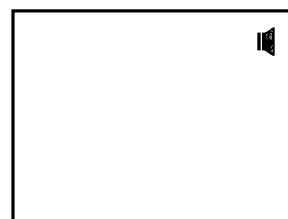

3. Use BREAK button.

Press **BREAK** button and the TV set goes into break mode. In this mode, the picture will be hidden and the volume becomes to half of the original volume. This function enables user to have a rest to protect the eyesight. Pressing **BREAK** button again or switching to other channel can exit this mode.

This function is useful in the following situations.

A. When you only want to listen to the sound, you can shield the picture to protect CRT.

B. When you use the TV set as an audio amplifier. In AV mode, you can input external audio CD signal to the audio inputs and switch the set to **BREAK** mode to avoid Auto-Power-Off function if there is no video input signal for 15 minutes.

C. When you are playing games and you do not want to see the background picture, you can shield the picture first and then enter into **Game**.

Clock Setting

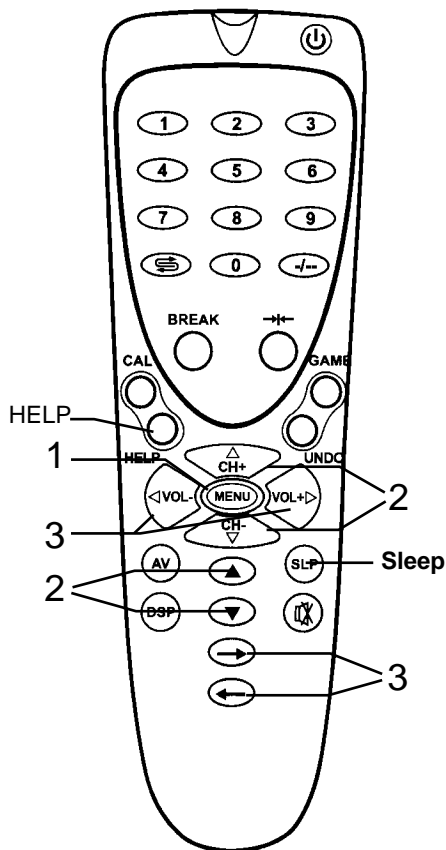
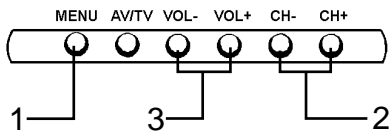
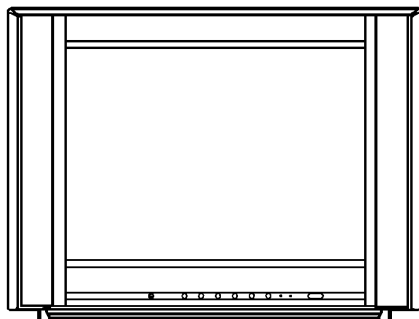

Setting sleep timer

Please enter the **Clock** menu and select **Sleep** item.
Press **VOL+** or **VOL-** button to select between Off, 10, 20, 30, 40, 50 and 60 (minutes). When the sleep time elapses, the TV set goes to **STANDBY** automatically.

You also can set the sleep time by using **SLP** button directly.

Clock	
▶ Sleep	60
Timer	--:--
TimeOff	██████
TimeOn	██████
Alarm	██████



Setting clock

Please enter the **Clock** menu and select **Timer** item.
Press **VOL+** or **VOL-** button to set current time.

Notes:
The **Time Off** and **Time On** items are available only after you finish setting the **Timer** item.

Clock	
Sleep	60
▶ Timer	10:00
TimeOff	--:--
TimeOn	--:--
Alarm	██████

Setting OFF timer

Please enter the **Clock** menu and select **TimeOff** item.
Press **VOL+** or **VOL-** button to set **OFF** time.
The TV set in working mode auto goes to **STANDBY** when the **OFF** time elapses.

Clock	
Sleep	60
Timer	10:00
▶ TimeOff	22:00
TimeOn	--:--
Alarm	██████

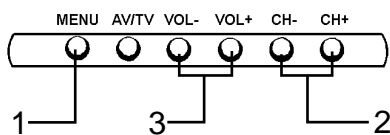
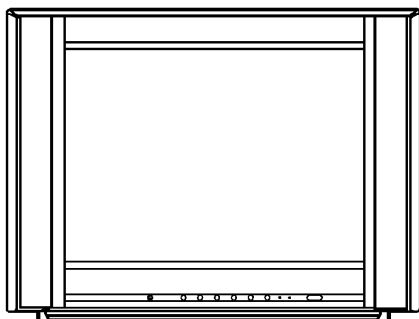

Setting ON timer

Please enter the **Clock** menu and select **TimeOn** item.

Press **VOL+** or **VOL-** button to set ON Time.

After you finish setting **Time On** item, press the **STANDBY** button on the remote control. Then the TV set auto turns on when your preset time elapses.

Clock	
Sleep	60
Timer	10 : 00
TimeOff	22 : 00
▶ TimeOn	18 : 00
Alarm Channel	--

Notes:

The **Alarm Channel** item is available only after you finish setting **Time On** item.

Setting alarm channel

Please enter the **Clock** menu and select **Alarm** item.

Press **VOL+** or **VOL-** button to select channel number.

When the preset ON time elapses, the set auto turns on and goes to the channel set on the **Alarm** item.

Clock	
Sleep	60
Timer	10 : 00
TimeOff	22 : 00
TimeOn	18 : 00
▶ Alarm Channel	99

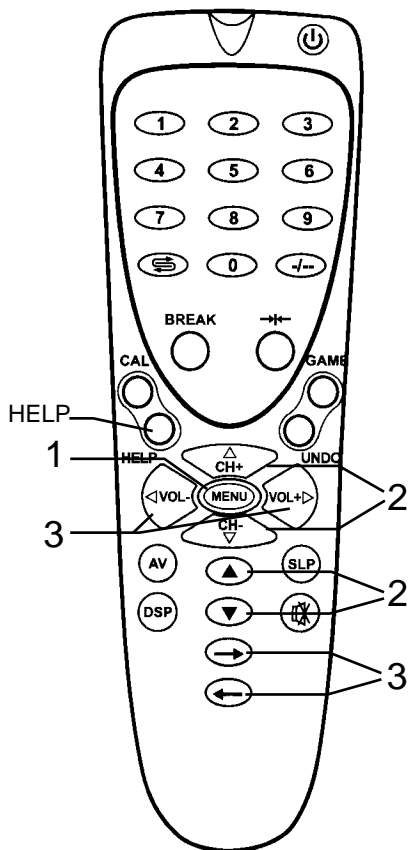

Notes:

1. When you adjust time by VOL+ or VOL- button, the increasing/ decreasing step of time is 1 minute in every press. If you press and hold the button for more than 1 second, the step of time is 1 hour.
2. Once the functions of Time On or Time Off fulfil, you need to set the On Time or Off Time again if you want to use this function next time.
3. After you finish setting Time Off item, if the set auto goes to STANDBY because there is no signal input for a continuous 15 minutes, or if you turn off manually, then the preset Off Time will be cancelled. As the same way, turn on the set in advance will cancel the Time On and Alarm Channel settings.
4. Once you turn off the set by press the Power Switch, all settings in the Clock menu page will be cancelled in next time's turning on.

System Setting

1. Press **MENU** button twice to display **System** menu.
2. Press **CH+/-** button to **select** item.
3. Press **VOL+/-** button to **adjust** the selected item.

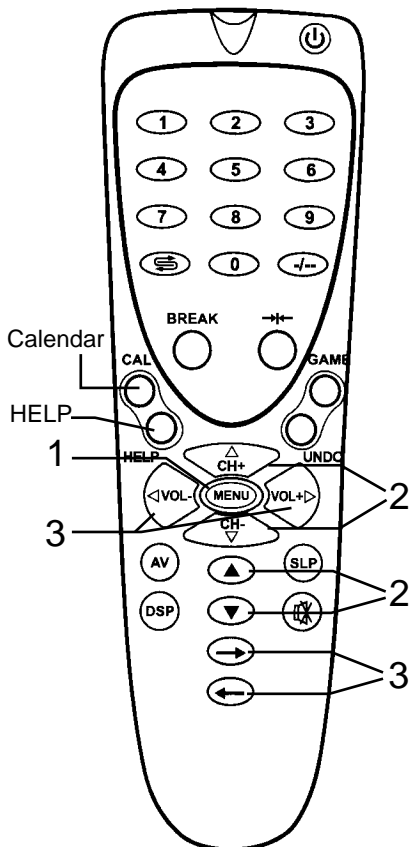
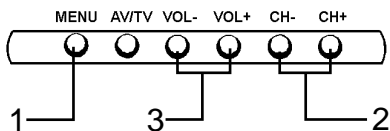
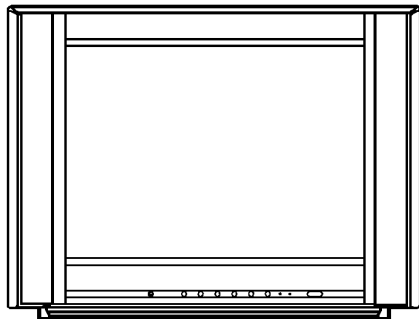

Setting OSD language

Please enter the **System** menu and select **Language** item.
Press **VOL+** or **VOL-** button to select the OSD Language.

System	
▶ Language	Eng/中文
BlueBack	Off
Calendar	Enter
Game	Enter
Safemode	Enter

Setting blue background

Please enter the **System** menu and select **BlueBack** item.
Press **VOL+** or **VOL-** button to select **On** or **Off**.
If you set the **BlueBack** item to **On**, when there is no signal or the signal is too poor, then a blue background and a dynamic map will appear.

System	
Language	Eng/中文
▶ BlueBack	On
Calendar	Enter
Game	Enter
Safemode	Enter

If you set the **BlueBack** item to **Off**, when there is no signal, the screen display a noisy picture.

Notes:

In the mode of screen saver, when the signal is re-input, the TV set will display the program in about 5 seconds because it needs to exist screen saver first.

Calendar

Please enter the **System** menu and select **Calendar** item.
Press **VOL+** or **VOL-** button to enter.

System	
Language	Eng/中文
BlueBack	On
▶ Calendar	Enter
Game	Enter
Safemode	Enter

In **Calendar** interface, press **CH+/-** buttons to select **year, month or date**; press **VOL+/-** buttons to adjust.
The **Calendar** is from 1901 to 2050.

Notes:

*You can also enter **Calendar** interface by using **CAL** button on the remote control.*

	SU	MO	TU	WE	TH	FR	SA
2008Y		01	02	03	04	05	
JAN	06	07	08	09	10	11	12
	13	14	15	16	17	18	19
	20	21	22	23	24	25	26
	27	28	29	30	31		

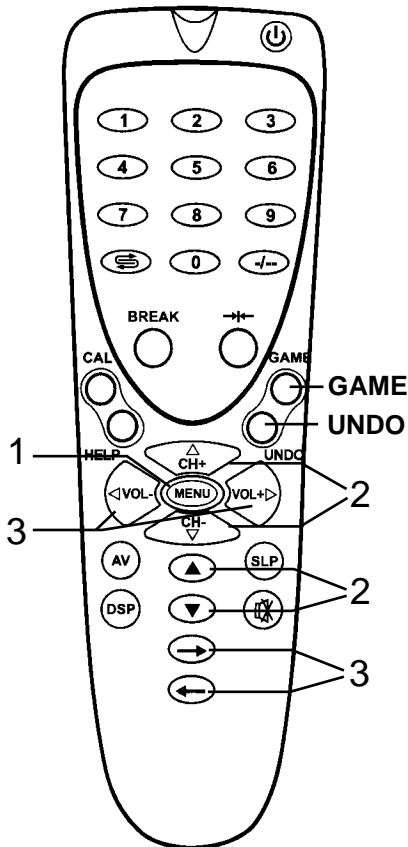
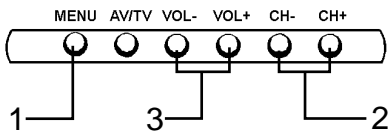
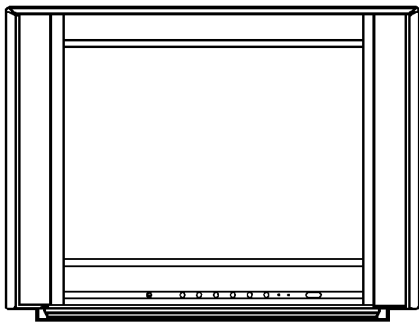

Playing Game

Please enter the **System** menu and select **Game** item.
Press **VOL+** or **VOL-** button to enter **Game Select** menu.

Press **CH+** or **CH-** button to select **Box Man Map** item and select a game map with **VOL+** or **VOL-** button.

Press **CH+** or **CH-** button to select **Game Start** item, press **VOL+** or **VOL-** to start game.

Notes;
You also can enter into Game interface directly by using **GAME** button

System	
Language	Eng/中文
BlueBack	On
Calendar	Enter
▶ Game	Enter
Safemode	Enter

Game Select	
▶ Box Man Map	5
Game Start	

How to play the name?

Description of icons:

- ⊙ :the man you control.
- ▣ :the box to push.
- :the destination to push the box to.
- ≡ :the wall.

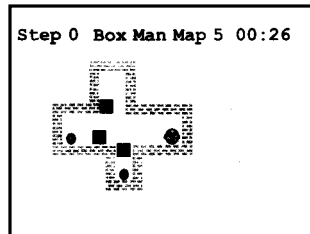

The player should control the man to push the box (just push, not pull) to the destinations within the wall by using **CH+ CH-**, **VOL+** and **VOL-** buttons. When you push all boxes to the relevant destinations then you win and it goes to next map.

You can press **UNDO** button to cancel your last action.

Press **GAME** button to exit game. If you want to play again then press **GAME** button again.

Notes:

1. You can not pull the box, but push it.
2. If there is wall in front of the box, you can not push it.
3. If there are two continual boxes, you can not push them.

Safe Mode

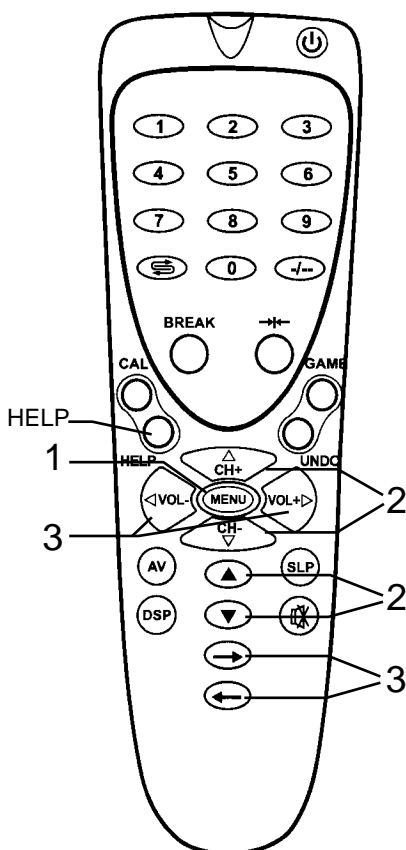
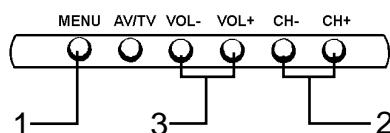
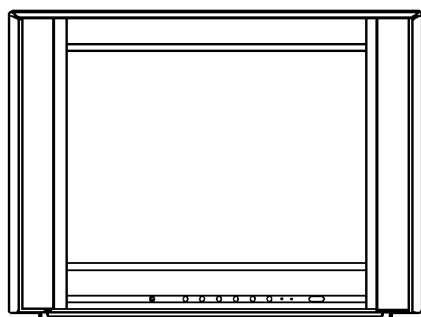

SafeMode introduction

Please enter the **System** menu and select **SafeMode** item.
 Press **VOL+** or **VOL-** button to enter SafeMode menu.
 If you never set password for **Safe Mode** or you set the **SafeMode** item to **Off**, you can directly enter into **SafeMode** menu without password, otherwise, a four digit password is necessary before you can enter into **SafeMode** menu. The TV set exit the menu automatically if you continuously input wrong password three times. There are nine items in the **SafeMode** menu. Press **CH+/-** buttons to select item and **VOL+/-** buttons to adjust.

System	
Language	Eng/中文
BlueBack	On
Calendar	Enter
Game	Enter
▶ Safemode	Enter

SafeMode	
▶ SafeMode	Off
VolLimit	██████
CH.Limit	██████
AdjLimit	██████
Search	██████

Setting SafeMode item

Please enter the **SafeMode** menu and select **SafeMode** item.
 Press **VOL+** or **VOL-** button to select **On** or **Off**.
 If you set this item to **On**, and set a password, you will be asked to input a password next time when you enter **SafeMode**. Therefore, please remember the password if you turn on the **SafeMode**. If you call the OSD, the screen displays "**SafeMode**" to indicate that the **SafeMode** is turned on.

SafeMode	
▶ SafeMode	On
VolLimit	100
CH.Limit	254
AdjLimit	On
Search	On

If the **SafeMode** is turned off, **the following items can not be accessed**, and the password is unnecessary when you enter the **SafeMode** menu.

Setting VolLimit item

Please enter the **SafeMode** menu and select **VolLimit** item.
 Press **VOL+** or **VOL-** button to select the limitation volume ranging from 0-100. For example, you set the limitation volume to 50, then the user can only adjust the volume from 0-50.

SafeMode	
SafeMode	On
▶ VolLimit	50
CH.Limit	254
AdjLimit	On
Search	On

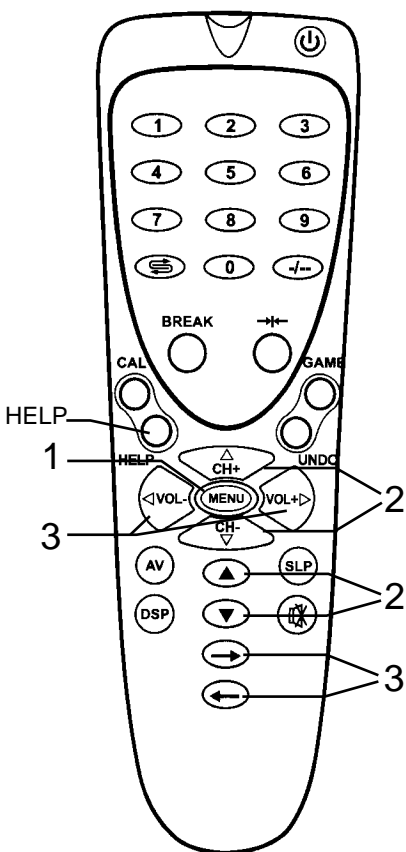
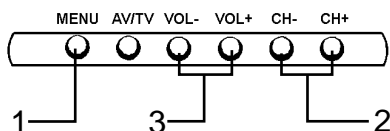
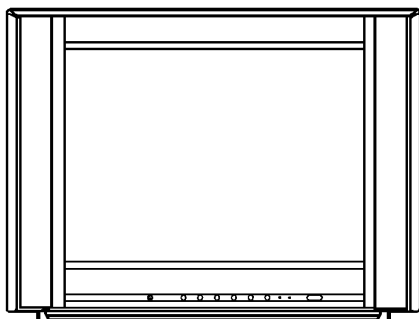

Setting CH.Limit item

Please enter the **SafeMode** menu and select **CH.Limit** item.

Press **VOL+** or **VOL-** button to select the limitation channel number ranging from 0-254.

For example, you can set the limitation channel number to 99, the the user can only select the channel from 0-99.

Making use of channel limitation and channel exchange functions, you can limit some channels and turn off the **Program** menu to forbid other user watching these channels programs.

SafeMode	
SafeMode	On
VolLimit	50
▶ CH.Limit	99
AdjLimit	On
Search	On

Setting AdjLimit item

Please enter the **SafeMode** menu and select **AdjLimit** item.

Press **VOL+** or **VOL-** button to select **On** or **Off**.

If you set this item to **Off**, the **Picture** menu will be shielded in normal watching. The user can not adjust picture.

SafeMode	
SafeMode	On
VolLimit	50
CH.Limit	99
▶ AdjLimit	Off
Search	On

Setting Search item

Please enter the **SafeMode** menu and select **Search** item.

Press **VOL+** or **VOL-** button to select **On** or **Off**.

If you set this item to **Off**, the **Program** menu will be shielded in normal watching. The user can not search program or tune the TV set.

SafeMode	
SafeMode	On
VolLimit	50
CH.Limit	99
AdjLimit	Off
▶ Search	Off

Setting OnInput item

Please enter the **SafeMode** menu and select **OnInput** item.

Press **VOL+** or **VOL-** button to select between **Off**, **AV** or **TV-0**.

If you select **Off**, the next time when you turn on by **Power Switch**, the TV set directly goes into the mode that you turn off last time.

If you select **AV**, next time when you turn on by **Power Switch**, the TV set directly goes into AV input mode.

If you select **TV-0**, net time you turn on by **Power Switch**, the TV set directly goes to channel 0.

SafeMode	
Search	Off
▶ OnInput	Off
OnSearch	Off
OnDemo	Off
Password	New

Safe Mode

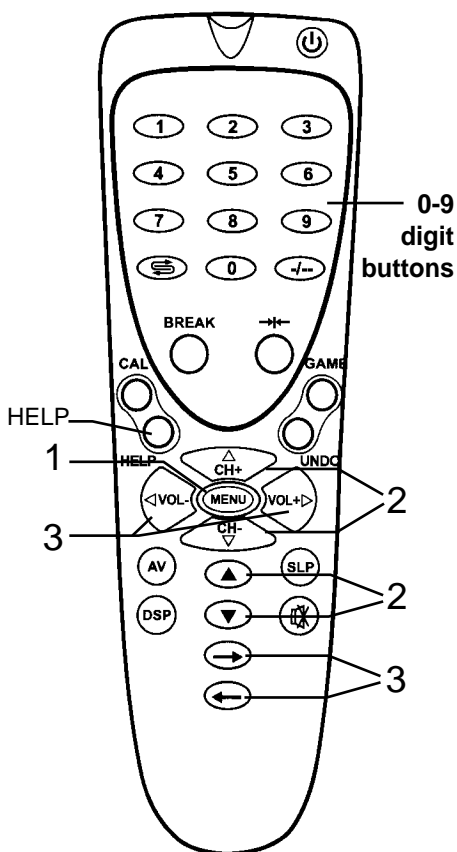
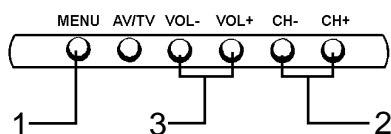
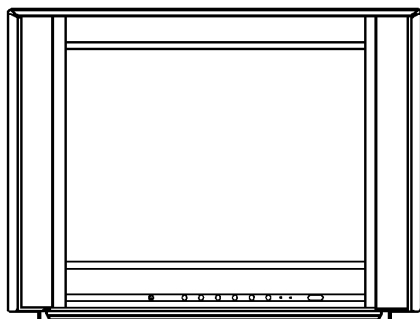

Setting OnSearch item

Please enter the **SafeMode** menu and select **OnSearch** item.

Press **VOL+** or **VOL-** button to select **On** or **Off**.

If you set this item to **On**, next time you turn on by **Power Switch**, the TV set searches program and set system automatically

(please make sure that the antenna connection is OK before you turn on). Once the **OnSearch** is fulfilled successfully, this item will be set to **Off** automatically so that the set does not search program when you turn on by **Power Switch** next time.

SafeMode	
Search	Off
OnInput	Off
▶ OnSearch	On
OnDemo	Off
Password	New

Setting OnDemo item

Please enter the **SafeMode** menu and select **OnDemo** item.

Press **VOL+** or **VOL-** button to select **On** or **Off**.

If you set this item to **On**, next time you turn on by **Power Switch**, the TV set demonstrates menu operation for about 1 minute first.

Once the **OnDemo** is fulfilled successfully, this item will be set **Off**.

SafeMode	
Search	Off
OnInput	Off
OnSearch	On
▶ OnDemo	On
Password	New

Setting PassWord item

If you want to set a new password, Please enter the **SafeMode** menu and select **Password** item.

Please input 4-digit password by using the 0-9 digit buttons first, then the set asks you to input again and you should input the same password again as you input first time. If you do so successfully, the new password will be accepted and the screen displays OK. Otherwise, the set asks you to repeat the above steps.

SafeMode	
Search	Off
OnInput	Off
OnSearch	On
OnDemo	On
▶ Password	New

Password *---

Password Repeat

Password OK

Notes:

If you forget your password and fail to enter the **SafeMode** menu, you can use the super password as "5 4 3 2" to enter. Now please set a new password and remember it.

Troubleshooting Guide

Before calling service personnel, please check the following chart for a possible cause to the trouble you are experiencing.

Symptoms	Check the following items
Power is not turned on	<ul style="list-style-type: none"> □ Be sure the power cord is plugged in.
Poor colour, poor tint	<ul style="list-style-type: none"> □ Contrast, colour, tint are not correctly adjusted.
Spots appear on the screen	<ul style="list-style-type: none"> □ Possible interferences of automobiles, motorcycle, trolley bus, neon lamps, etc.
Stripes appear on the screen	<ul style="list-style-type: none"> □ Possible interference of electronic interference from another TV set, a computer, an electronics game machine, a broadcast station, etc.
Double images or "ghosts"	<ul style="list-style-type: none"> □ This may be caused by reflections from nearby mountains or buildings. □ Check the antenna direction.
Snowy picture	<ul style="list-style-type: none"> □ It is possible that the aerial "lead-in" is damaged or comes off. □ Check the antenna direction.
Any one of the following: <ul style="list-style-type: none"> ▶ No picture menu page ▶ No program menu page ▶ The maximum volume can reach 100 ▶ Some Channels can not be accessed 	<ul style="list-style-type: none"> □ Press "DSP" button to check whether the TV set is in Safe Mode.
TV cabinet creaks	<ul style="list-style-type: none"> □ Even if the picture or the sound is normal, changes in room temperature sometimes makes the TV cabinet expand or contract, making a noise. This does not indicate a malfunction.
Remote controller does not work	<ul style="list-style-type: none"> □ The batteries may be worn out. □ The batteries may be installed with their polarity reversed.
Unevenness in colour in some parts of the screen	<ul style="list-style-type: none"> □ When the set is switched on, do not shift or move the set around. Sometimes it may develop an unevenness in colour in some parts of the screen. This can be eliminated by switching off the set with the POWER switch and wait for 10 minutes before switching on again.

Specifications

Power Supply: AC 240V, 50Hz
Power Consumption: 70W
Dimensions (mm): 612 (W) x 466 (H) x 476 (D)
Weight: 23 kg
CRT: 51 cm

TV system & channel range

System	VHF	UHF	CATV
PAL-B/G	2-12	21-69	X~Z+2,S1~S41

Colour System: PAL-B/G NTSC playback
Sound output: 1.5W x 2
Accessories: Remote controller X 1

ⓘ Design and specifications are subject to change without notice.

PALSONIC CORPORATION PTY LTD
1 JOYNTON AVENUE
WATERLOO NSW 2017 AUSTRALIA
TEL: (02) 9313 7111
FAX: (02) 9313 7555
www.palsonic.com.au

**PALSONIC CUSTOMER SERVICE
TELEPHONE
AUSTRALIA: 1300 657 888**