

Open-Drive Centrifugal Liquid Chillers

SAFETY CONSIDERATIONS

Centrifugal liquid chillers are designed to provide safe and reliable service when operated within design specifications. When operating this equipment, use good judgment and safety precautions to avoid damage to equipment and property or injury to personnel.

Be sure you understand and follow the procedures and safety precautions contained in the machine instructions as well as those listed in this guide.

▲ DANGER

DO NOT USE OXYGEN to purge lines or to pressurize a machine for any purpose. Oxygen gas reacts violently with oil, grease and other common substances.

NEVER EXCEED specified test pressures. VERIFY the allowable test pressure by checking the instruction literature and the design pressures on the equipment nameplate.

DO NOT VALVE OFF any safety device.

BE SURE that all pressure relief devices are properly installed and functioning before operating any machine.

▲ WARNING

DO NOT USE eyebolts or eyebolt holes to rig machine sections or the entire assembly.

DO NOT work on high voltage equipment unless you are a qualified electrician

DO NOT WORK ON electrical components, including control panels, switches, starters or oil heater until you are sure ALL POWER IS OFF and no residual voltage can leak from capacitors or solid-state components

LOCK OPEN AND TAG electrical circuits during servicing. IF WORK IS INTERRUPTED, confirm that all circuits are de-energized before resuming work.

DO NOT syphon refrigerant by mouth.

AVOID SPILLING liquid refrigerant on skin or getting it into the eyes USE SAFETY GOGGLES. Wash any spills from the skin with soap and water. If any enters the eyes, IMMEDIATELY FLUSH EYES with water and consult a physician.

NEVER APPLY an open flame or live steam to a refrigerant cylinder. Dangerous overpressure can result. When necessary to heat refrigerant, use only warm (110 F/43 C) water

DO NOT REUSE disposable (nonreturnable) cylinders nor attempt to refill them. It is DANGEROUS AND ILLEGAL. When cylinder is emptied, evacuate remaining gas pressure, loosen the collar and unscrew and discard the valve stem. DO NOT INCINERATE.

CHECK THE REFRIGERANT TYPE before charging machine. High pressure refrigerant in a low pressure machine can cause vessels to rupture if the relief devices cannot handle the refrigerant volume.

DO NOT ATTEMPT TO REMOVE fittings, covers, etc.

while machine is under pressure or while machine is running. Be sure pressure is at zero psig before breaking any refrigerant connection.

CAREFULLY INSPECT all relief valves, rupture discs and other relief devices AT LEAST ONCE A YEAR. If machine operates in a corrosive atmosphere, inspect the devices at more frequent intervals.

DO NOT ATTEMPT TO REPAIR OR RECONDITION any relief valve when corrosion or build-up of foreign material (rust, dirt, scale, etc.) is found within the valve body or mechanism. Replace the valve.

DO NOT VENT refrigerant relief valves within a building, refer to ANSI B9.1. The accumulation of refrigerant in an enclosed space can displace oxygen and cause asphyxiation.

DO NOT install relief valves in series or backwards.

USE CARE when working near or in line with a compressed spring. Sudden release of the spring can cause it and objects in its path to act as projectiles.

▲ CAUTION

DO NOT STEP on refrigerant lines. Broken lines can whip about and cause personal injury.

DO NOT climb over a machine. Use platform, catwalk or staging. Follow safe practices when using ladders.

USE MECHANICAL EQUIPMENT (crane, hoist, etc.) to lift or move inspection covers or other heavy components. Even if components are light, use such equipment when there is a risk of slipping or losing your balance.

DO NOT WELD OR FLAME CUT any refrigerant line or vessel until all refrigerant has been transferred from the vessel to storage.

BE AWARE that certain automatic start arrangements CAN ENGAGE THE STARTER. Open the disconnect ahead of the starter in addition to shutting off the machine or pump

USE only repair or replacement parts that meet the code requirements of the original equipment

DO NOT VENT OR DRAIN water boxes containing industrial brines, liquid, gases or semisolids without permission of your Process Control Group.

DO NOT LOOSEN water box cover bolts until the water box has been completely drained.

DOUBLE-CHECK that coupling nut wrenches, dial indicators or other items have been removed before rotating any shafts.

DO NOT LOOSEN a packing gland nut before checking that the nut has a positive thread engagement.

PERIODICALLY INSPECT all valves, fittings and piping for corrosion, rust, leaks or damage

PROVIDE A DRAIN connection in the vent line near each pressure relief device to prevent a build-up of condensate or rain water.

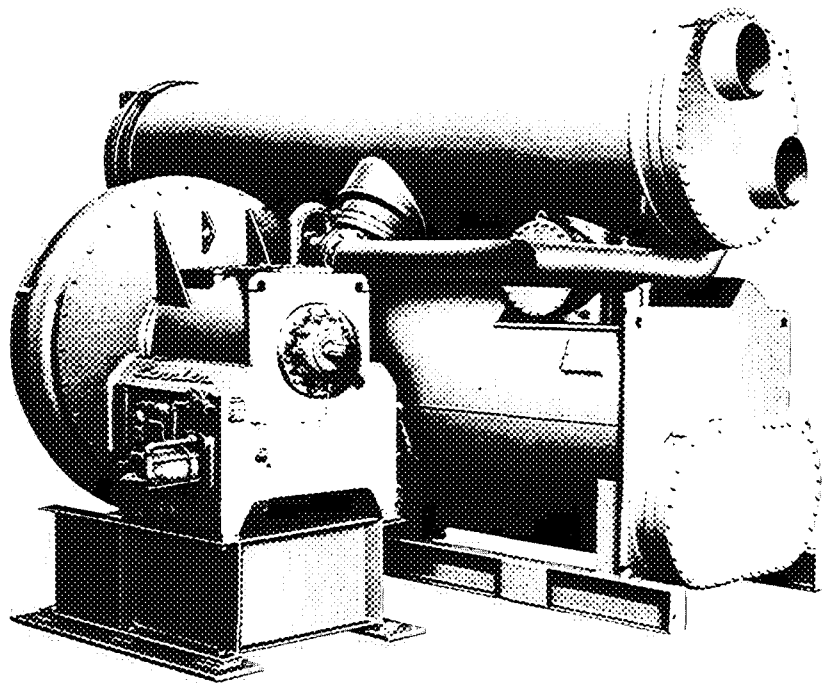

CONTENTS

	Page
SAFETY CONSIDERATIONS	1
INTRODUCTION	2
General	2
Job Data Required	2
Equipment Required	2
INITIAL PREPARATION	4
Machine Tightness	4
Check for Large Leaks	4
Check for Small Leaks	4
Check Leakage Rate	5
Machine Dehydration	5
Pumpout Procedures	5
Recheck Alignment	6
Check Grouting	6
Inspect Piping	6
Field Wiring	6
Lubrication	6
Refrigerant Charge	6
Drive	7
Purge	7
Air Supply (Pneumatic Control Only)	7
Check Safety Control Operation (Electric Motor Drive)	7
Check Safety Control Operation (Gas or Turbine Drive)	8
START-UP	10
Preliminary Checks	10
Compressor Rotation and Operation	10
Checking Safety Control Settings	10
Setting Operating Controls – Electronic	12
Setting Operating Controls – Pneumatic	13
Trimming Refrigerant Charge	14
Hot Alignment Check	14
Doweling	15
INSTRUCTING THE CUSTOMER OPERATOR	15

INTRODUCTION

General – All persons involved in start-up and operation of the 17CB machine should be familiar with these instructions and all necessary job data before initial start-up. Instructions are arranged in the proper sequence for machine start-up. **MACHINES WITH SPECIAL COMPONENTS AND/OR CONTROLS MAY REQUIRE SPECIAL START-UP PROCEDURES OR ADJUSTMENTS. CHECK YOUR INDIVIDUAL JOB REQUIREMENTS.**

Job Data Required

1. List of applicable design temperatures and pressures
2. Machine assembly, wiring and piping prints
3. Prints and instructions for special controls
4. 17CB Installation Instructions
5. 17CB Operating and Maintenance Instructions
6. Manufacturer's Installation and Start-Up Instructions for:
 - a. Drive
 - b. Gear (if applicable)
7. 5F,H Installation Instructions (Refrigerant 114 machines only)

Equipment Required

1. Mechanic's tools
2. Volt-ohmmeter and clamp-on ammeter
3. Manometer, absolute pressure type
4. Leak detector, halide or electronic
5. Refrigerant drum charging valve (Fig. 5)
6. 5/8-in. SAE x 3/4-in. MPT adapter
7. Five to 10 ft of copper tubing or plastic hose to fit 5/8-in. SAE connections
8. Portable vacuum pump, 5 to 7.5 cfm or larger

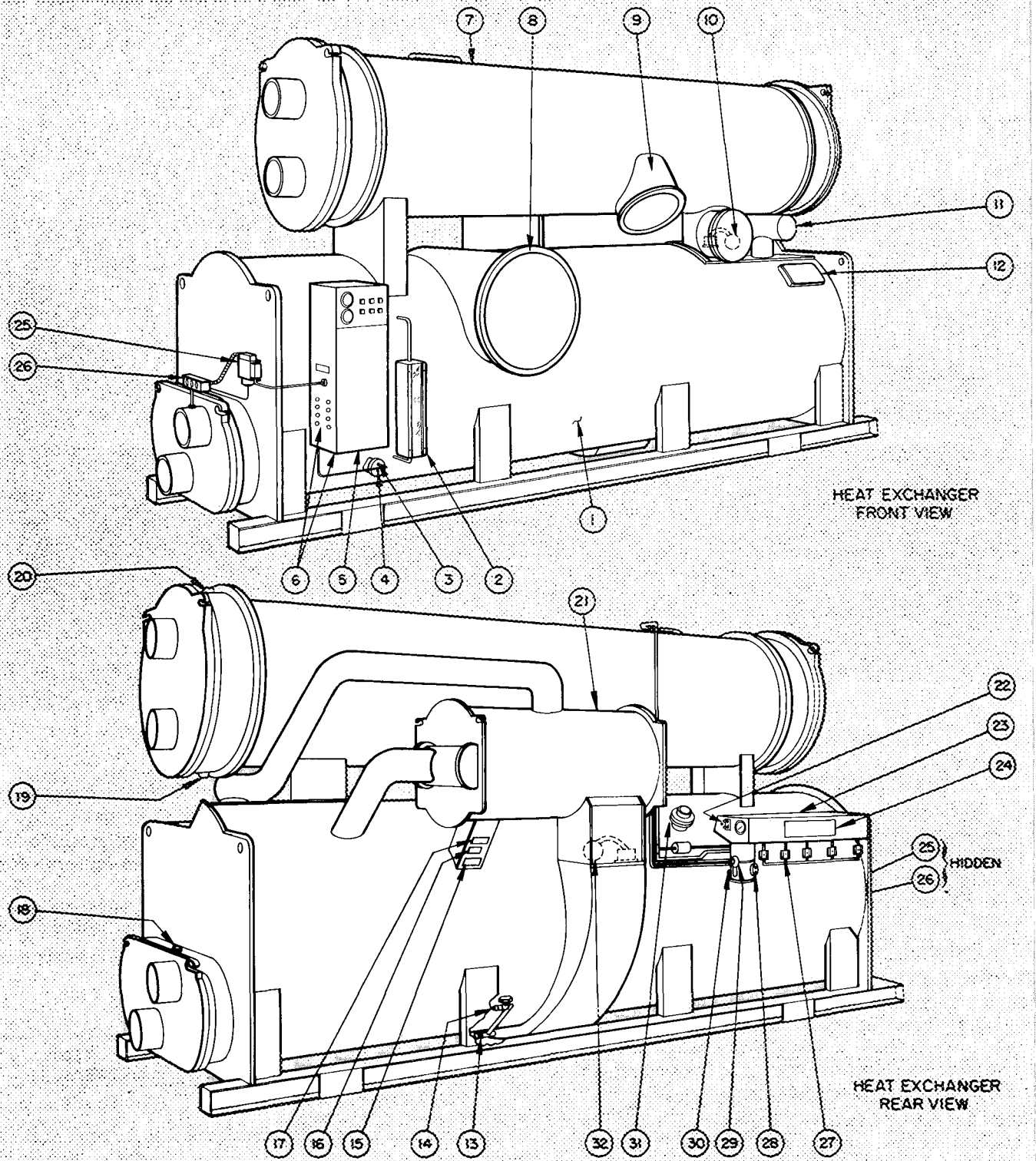

LEGEND

- | | | |
|---|---|---|
| <ul style="list-style-type: none"> 1. Cooler 2. Cooler Refrigerant Level Sight Glass 3. Low Refrigerant Temperature Bulb 4. Thermometer Well 5. Machine Control Center (See Fig. 8 and 9.) 6. Knockouts for Field Wiring 7. Condenser 8. Cooler Suction Pipe 9. Condenser Discharge Pipe 10. Condenser Float Valve 11. Economizer Pipe | <ul style="list-style-type: none"> 12. Cooler-Economizer Equalizing Damper Access Cover 13. Refrigerant Connection, 1-1/2 NPT 14. Cooler Charging Valve, 3/4 NPT 15. ASME Nameplate 16. Machine Informative Plate 17. Safety Code Sticker 18. Cooler Waterbox Vent, 3/4 NPT 19. Condenser Waterbox Drain, 3/4 NPT 20. Condenser Waterbox Vent, 3/4 NPT 21. Economizer | <ul style="list-style-type: none"> 22. Purge Operating Switch 23. Thermal Purge 24. Purge Valve Operation Plate 25. Chilled Water Low-Temperature Cutout 26. Chilled Water Temperature Probe 27. Purge Operating Valves 28. Purge Refrigerant Level Sight Glass 29. Purge Water Level Sight Glass 30. Purge Water Drain Valve 31. Rupture Disc Assembly 32. Economizer Float Valve |
|---|---|---|

Fig. 1 – 17CB Machine Components (R-11 Unit shown)

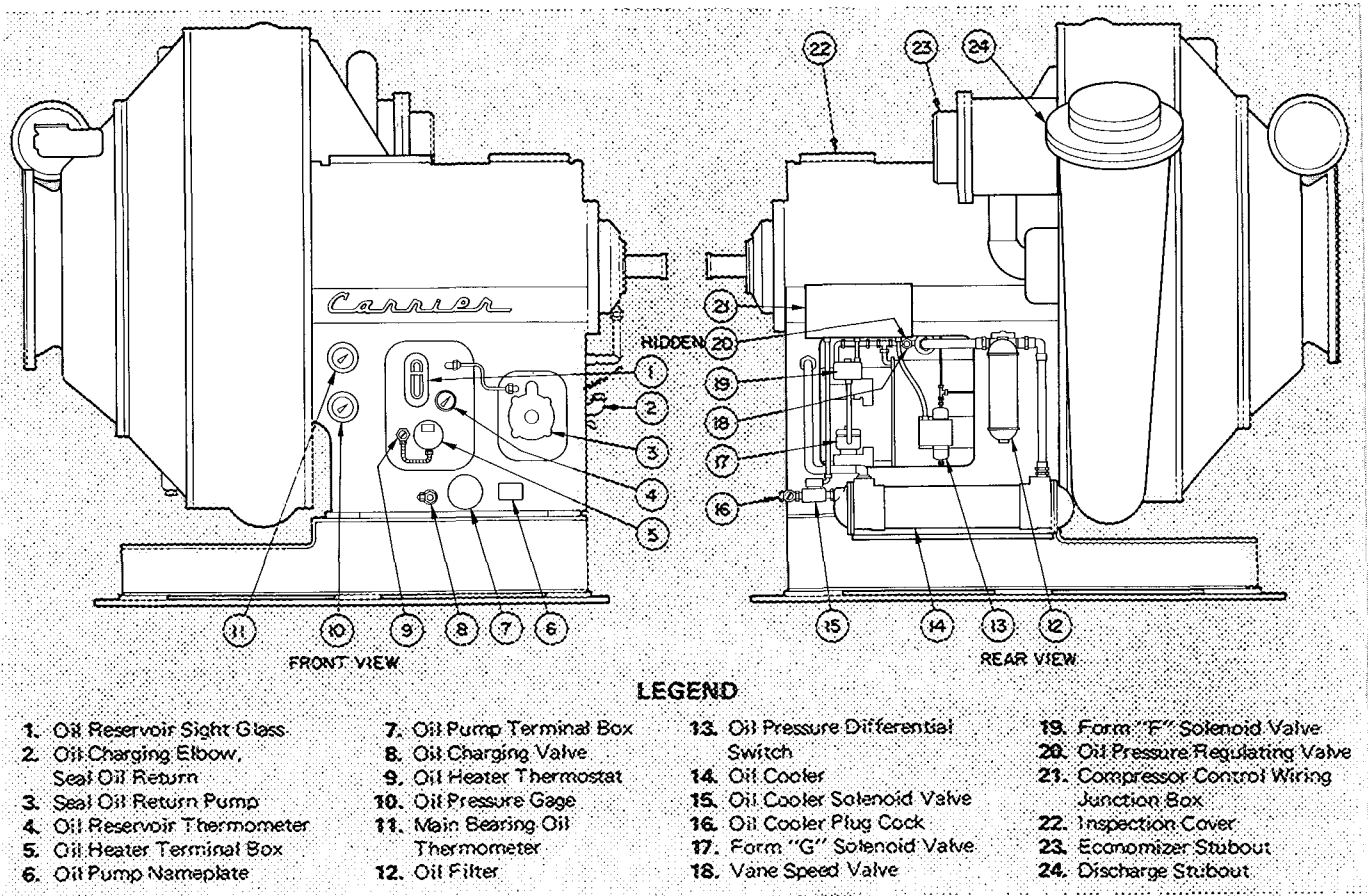

Fig. 2 — 17CB Centrifugal Compressor

INITIAL PREPARATION

CAUTION: Do not start compressor or oil pump, even for a rotation check, unless compressor is charged with oil and machine charged with refrigerant.

Do not apply voltage of any kind while machine is under dehydration vacuum.

Machine Tightness — If machine leak testing and dehydration was not completed at installation, check machine tightness (including pumpout system) as described below. Dehydration must be repeated if machine has been idle for several weeks or more after initial dehydration.

Check for Large Leaks — Using one of the methods described below, pressurize the machine to the level listed in Table 1. *Do not exceed test pressure.* Listen for large leaks as the pressure builds up. If test pressure holds for one hour, proceed with Check for Small Leaks.

All 17CB machines may be pressurized with cylinders of dry air or nitrogen thru the cooler charging valve. Dry air or nitrogen charging is preferable to purge or pumpout charging as it ensures that moisture will not be introduced into the machine. To pressurize with nitrogen (or dry air):

1. Connect a copper tube from charging valve to pressure cylinder. Never apply full cylinder pressure to the pressurizing line. Follow steps 2 thru 5 in proper sequence.

2. Open cooler charging valve fully.
3. Open cylinder regulating valve slowly.
4. Observe cooler or condenser pressure gage and close cylinder regulating valve when pressure reaches test pressure listed in Table 1.

Do not exceed test pressure!

5. Close cooler charging valve. Remove copper tube.

Table 1 — Test Pressures

MACHINE SIZE	REFRIG	TEST PRESSURE
17CB1300 thru 1600	R-11	8 to 10 psig
17CB1800 thru 2000	R-114	30 to 35 psig

Refrigerant 11 machines may be pressurized with the purge pump. Ensure that electrical supply to purge pump is 120 volts. Then follow operation 3 on the purge valve chart (item 24, Fig. 1).

Refrigerant 114 machines may be pressurized with the pumpout unit. This method is detailed in the section entitled Pumpout Procedures.

Check for Small Leaks

1. Pull a vacuum equal to 5 in. Hg (12.5 psia) by using purge pump operation 2 (Refrigerant 11 machines), pumpout unit (Refrigerant 114 machines) or by applying a vacuum pump at the cooler charging valve.

- Charge approximately 25 lb of the proper refrigerant thru the cooler charging valve.
- Pressurize machine to test pressure (Table 1) using dry air or nitrogen, or purge or pumpout unit. *Do not exceed test pressure.*
- Test all joints, valves, fittings etc. with a halide or electronic leak detector.

Check Leakage Rate

- Install a mercury manometer (absolute pressure type) on a tee at the cooler charging valve.
- Pull 25 in. of vacuum on the machine.
- Let machine stand with this vacuum for at least 8 hours.
- If leakage rate is less than 0.1 in. Hg in 24 hours (0.033 in. Hg in 8 hours), machine is sufficiently tight. Perform Machine Dehydration.
- If leakage rate exceeds 0.1 in. Hg per 24 hours, repeat Check for Small Leaks, repair leaks and repeat this Leakage Rate Check.
- Remove or valve off manometer before repeating any pressure test.

Machine Dehydration

→ Before dehydration, drain shipping oil and flush oil reservoir. Shipping oil vaporizes under vacuum and can greatly inhibit dehydration.

CAUTION: Do not attempt to start oil pump or purge motor even for a rotation check, nor apply test voltage of any kind while machine is under dehydration vacuum. Motor insulation breakdown and serious damage may result.

- Connect dehydration pump to cooler charging valve.
- Ensure that all valves on purge assembly are closed.
- Install mercury thermometer (absolute pressure type) at charging valve tee.
- Operate pump until manometer reads 29.80 in. Hg vacuum (0.1 psia). Continue to operate pump for 2 more hours.
- Close cooler charging valve; stop pump; record manometer reading.

- Wait 2 hours and read manometer again. If vacuum has not decreased, dehydration is complete. If vacuum has decreased, repeat steps 4, 5 and 6.
- If vacuum fails to hold after several dehydration attempts, check for machine leak by repeating the refrigerant pressure test.

Pumpout Procedures, Refrig 114 Units (See Fig. 3) MACHINE EVACUATION (No refrigerant in system)

- Set purge valves per operation 5 on purge valve operation plate.
- Jumper low-pressure cutout on pumpout compressor.
- Close valves 1, 3, 7 and 10.
- Open valves 2, 4, 5, 6, 8, 9 and 11.
- Disconnect separable union between pumpout condenser and oil separator.
- Run pumpout compressor until desired machine vacuum is reached.
- Close valve 5 and reassemble union.
- Stop compressor.
- Remove jumper.

PRESSURIZING THE MACHINE (No refrigerant in system)

- Set purge valves per operation 4 on purge valve operation plate.
- Close valves 2, 4 and 10.
- Open valves 1, 3, 5, 6, 7, 8, 9 and 11.
- Disconnect separable union in pumpout compressor suction line.
- Operate pumpout compressor until desired pressure is reached. *Do not exceed test pressure listed in Table 1.*
- Shut off pumpout compressor.
- Reassemble union.
- Return purge valves to Normal-Auto condition when pressurizing is completed.

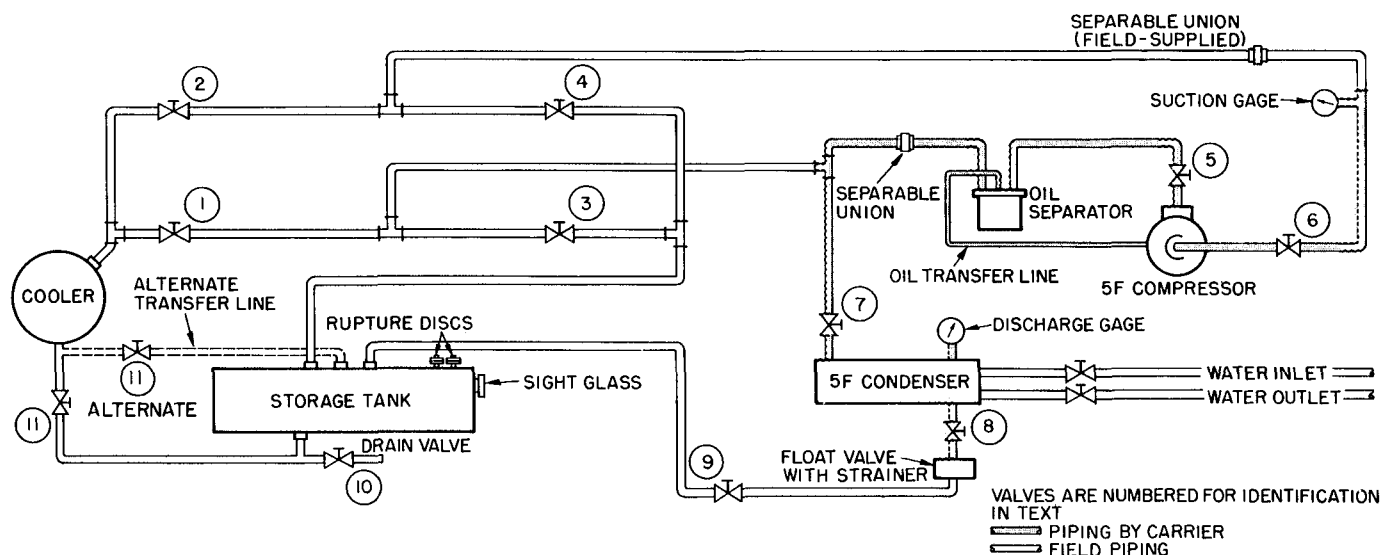

Fig. 3 – Pumpout System Schematic (R-114 Units)

Recheck Alignment — Angular and parallel alignment must be within coupling manufacturer's specified tolerances before machine is operated. Refer to Carrier Standard Service Techniques Manual, Chapter 15, for checking methods.

Leave couplings disassembled until drive is tested and operated.

Check Grouting — Make sure grouting was applied during installation. Grouting should be completed before machine is operated.

Inspect Piping — Refer to piping diagrams provided in Job Data and inspect piping to cooler, condenser and oil cooler.

Chilled water should enter the lower nozzle of the cooler and leave at the upper nozzle. Chilled water temperature probe should be installed in leaving chilled water line.

Condenser water should enter the upper condenser nozzle and leave at the lower.

Ensure that pipes are vented and properly suspended, with no stress on nozzles or water box covers.

Measure water pressure drop across cooler and condenser or across the pumps. Check to see that water flow agrees with design flow.

Oil cooler water must be clean, with 85 F maximum temperature and 200 psi maximum inlet pressure. Refer to tag attached to cooler inlet connection for pressure drop and velocity limits.

Check that any drive piping is installed per manufacturer's instructions.

Field Wiring

WARNING: Do not attempt to check high voltage supply without proper equipment and procedure. Serious personal injury can result.

Check with power company for specific instructions.

Refer to Job Data wiring diagrams and check field wiring as follows:

1. Wiring, voltage, supply, and rotation of all electrical equipment: brine pump, condenser water pump, tower fan.
2. Overload settings on all motor starters.
3. Wiring on all electrical devices on drive: auxiliary oil pumps, pump starters, etc.
4. Wiring between drive and control center and compressor junction box.
5. Wiring to pumpout compressor.
6. Oil pump starter voltage against oil pump nameplate voltage.

Lubrication

→ **COMPRESSOR** — Drain and flush out all shipping oil; then charge oil shipped with machine. It conforms to Carrier oil specifications for centrifugal compressors (listed in the Operating and Maintenance Instructions). Charge thru oil reservoir charging valve (item 8, Fig. 2) to middle of reservoir sight glass. Machine vacuum draws oil from container.

Oil may also be added thru charging elbow (item 2) in seal oil return chamber. The pump (item 3) automatically transfers oil to the oil reservoir.

IMPORTANT: After charging oil, energize oil heater (from its separate 120-volt source) to minimize refrigerant absorption in the oil. Oil heater indicating light comes on when heater is energized. The thermostat should be set to maintain a minimum temperature of 140 F at shutdown. Adjust if required.

On pneumatic machines only, add a small amount of oil to the vane seal chamber thru 1/4-in. pipe plug (Fig. 4) until level reaches bottom of rack and gear as seen thru Plexiglas cover.

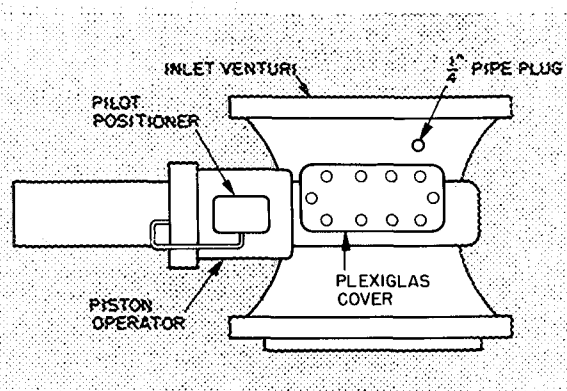

Fig. 4 — Pneumatic Vane Shaft Seal Chamber

WARNING: Do not start oil pump, even for a rotation check, with machine in dehydration vacuum. Check rotation only after compressor has been charged with oil and cooler has been charged with refrigerant.

COUPLINGS — Lubricate couplings after they have been reassembled. Follow manufacturer's recommendations for type of lubricant and lubrication procedure.

NOTE. Do not reassemble couplings until drive has been run separately.

SPEED INCREASING GEAR — Fill gear casing with oil recommended by manufacturer. DO NOT OVERFILL.

DRIVE — Refer to drive manufacturer's instructions for proper lubrication.

AUXILIARIES — Check all auxiliary pump motor bearings for proper lubrication. Fill all oilers used on shaft seals, bearings, etc.

Refrigerant Charge

1. Install a charging valve in the 3/4-in. drum opening as shown in Fig. 5.
2. Connect a short length of plastic hose (R-11 only) or copper tubing from drum valve to cooler charging valve.
3. Circulate chilled water during the charging process.

4. At a vacuum greater than that indicated in Table 2, refrigerant will flash into gas and may cause tube freeze-up. Keep refrigerant drums upright and admit refrigerant as a gas until cooler vacuum is less than that listed in Table 2.
5. The refrigerant supplied with the machine is in excess of that required for initial charging. Charge the amount shown in Table 3, *less 200 pounds*.
6. After the machine has been started, it may be necessary to adjust the charge for optimum machine performance. For this adjustment, see Trimming Refrigerant Charge.

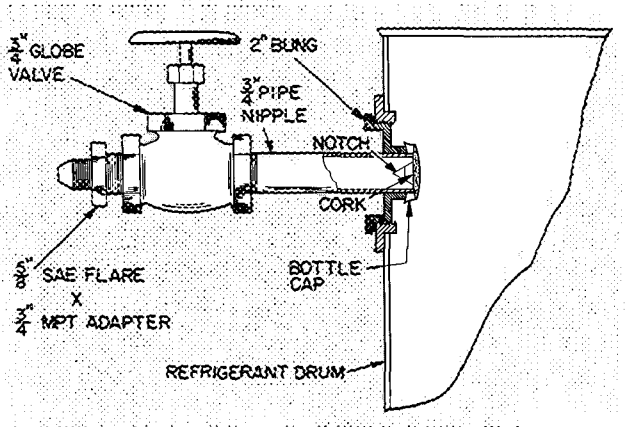

Fig. 5 – Drum Charging Valve

Table 2 – Pressures Corresponding to 32 F Saturation Temperature

REFRIGERANT	PRESSURE (in. Hg vacuum)
11	18.05
114	3.85

Table 3 – Refrigerant Shipping Charges

MACHINE SIZE	REFRIG	SHIPPING CHARGE (lb)
17CB1300	11	2800
17CB1400	11	3250
17CB1500	11	3250
17CB1600	11	3500
17CB1800	114	4400
17CB2000	114	4400

Drive – It is good practice to operate the drive separately before operating compressor. Refer to drive manufacturer's instructions for drive protection devices and settings. Check turbine over-speed at this time. Reassemble couplings after operating drive separately.

If drive is wired for automatic starting, it will start when compressor START button is pushed.

Starting procedure of manually started drives may be initiated after START button is pushed.

Purge – Place the purge operating valves (Fig. 1) in "Normal-Automatic" position as indicated in operation 1 on the purge valve operation plate (item 24, Fig. 1). Operate the purge momentarily by placing the purge switch in "Manual" position; then place purge switch in "Auto" position.

Air Supply – Pneumatic Control Only – Check 25 psi air supply to pneumatic temperature controller and pilot positioner.

Check Safety Control Operation (Electric Motor Drive)

NOTE: Motor high temperature cutout is field supplied only per customer's request.

As the following checks are made, control panel lights should appear as indicated in the diagrams.

– OFF

– ON

1. Open main disconnect (all power off to starter and controls). Disconnect main motor leads in starter.

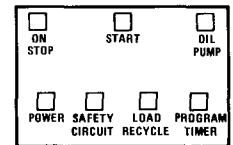

2. Provide control circuit power.

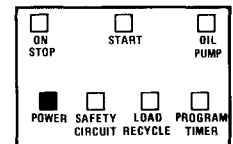

3. Press ON-STOP button (light goes on). If SAFETY CIRCUIT light does not go on, check resets on condenser high-pressure safety, low refrigerant safety, bearing and motor high temperature circuit breakers and compressor overloads in starter. Check 3-amp fuse in control center.

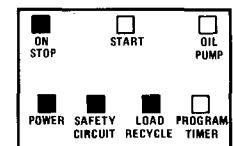

If SAFETY CIRCUIT light goes on but LOAD RECYCLE light stays off, check the chilled water recycle switch (auto-reset).

If both lights go on, manually trip and reset motor and bearing high temperature circuit breakers, compressor motor overloads and low refrigerant temperature cutout to be sure they cut off the safety light. Tripping the chilled water recycle switch will cut off the LOAD RECYCLE light only.

4. Press ON-STOP button (light goes out). Remove and tag gray striped wire from control center terminal 17. Refer to machine control schematic in the Operating and Maintenance Instructions for terminal location.

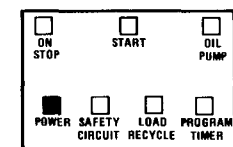

5. Start chilled water and condenser water pumps. Press ON-STOP button (light goes on).

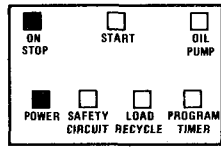

6. Press OIL PUMP button for several seconds. Pump should raise pressure 25 to 27 psi above refrigerant pressure at machine shutdown condition. SAFETY CIRCUIT and LOAD RECYCLE lights should go on.

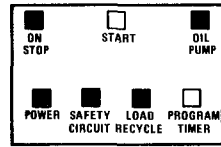

7. Release OIL PUMP button. SAFETY CIRCUIT light and LOAD RECYCLE light should go out.

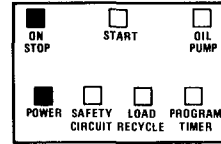

8. With OIL PUMP button depressed, alternately stop and restart chilled water and condenser water pumps. SAFETY CIRCUIT and LOAD RECYCLE lights should go out as each pump stops. (Continuous operation of oil pump is unnecessary during these checks.)

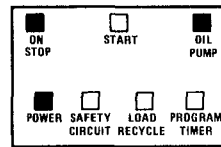

9. Shut off water pumps. Release OIL PUMP button. Press ON-STOP button (light out). Replace tagged wire on terminal (17).

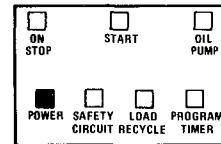

10. Press ON-STOP button (light goes on).

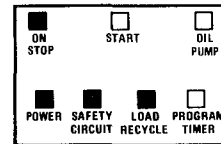

11. Press machine START button (motor leads disconnected).

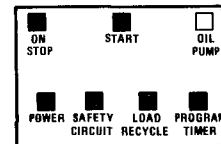

Oil pump starts within 30 seconds.

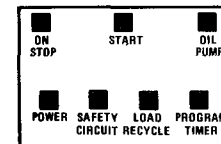

Compressor motor start contacts will close 30 seconds later. Starter will transfer to its run condition 30 to 60 seconds after starter is energized.

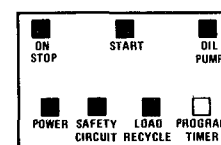

12. Open oil pump main disconnect. Starter must de-energize. OIL PUMP light will remain on for approximately 5 minutes.

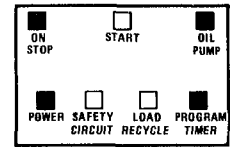

OIL PUMP light goes out.

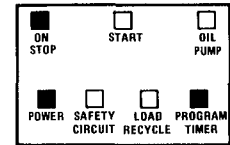

13. Close oil pump disconnect. In approximately 10 minutes the program timer will complete the anti-recycle portion of its cycle and machine is ready to restart. (Total recycle time is 15 minutes.)

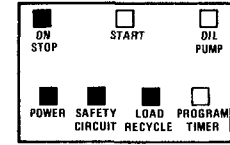

14. Remove all power. Reconnect motor leads. Restore power.

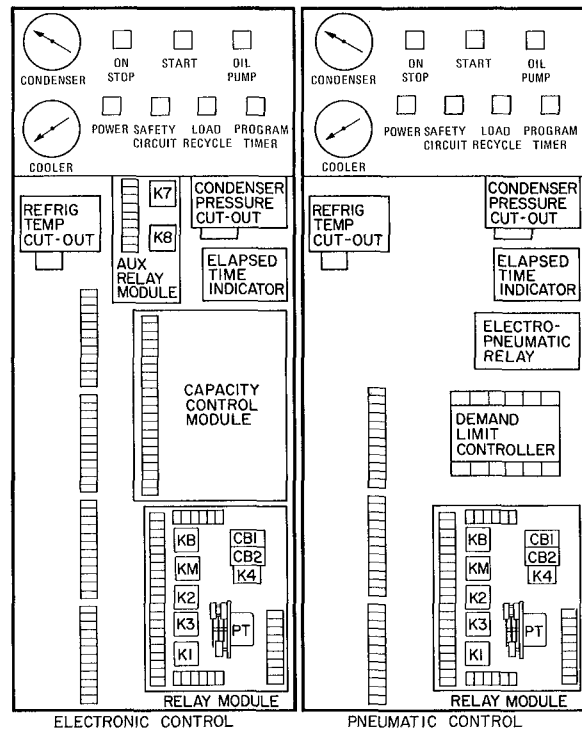

Fig. 6 - Control Center Components (Electric Motor Drive)

Check Safety Control Operation (Gas Engine or Turbine Drive)

Refer to machine control schematic in the Operating and Maintenance Instructions for location of electrical terminals listed.

As checks are made, control panel lights should appear as indicated in the diagrams.

1. Turn off main steam or gas supply to prevent drive from starting. Place jumpers across oil switch terminals (67) and (68)

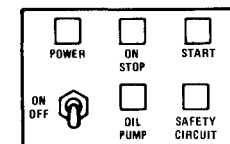

and flow switch terminals (69) and (70) inside the control center.

2. Provide control circuit power.

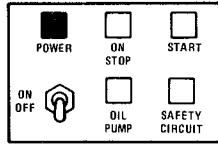

3. Press ON-STOP button (light on). If SAFETY CIRCUIT light does not go on, check resets on condenser high-pressure safety, cooler low refrigerant safety, bearing high temperature circuit breaker, chilled water low temperature switch and driver overload in starter. Check 3-amp fuse in control center.

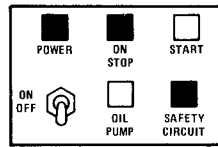

Manually trip and reset the bearing high temperature circuit breaker, driver overload, low refrigerant safety and chilled water switch to be sure they cut off the safety light.

4. Press ON-STOP button (light goes out). Remove jumpers across terminals 67 and 68, 69 and 70.

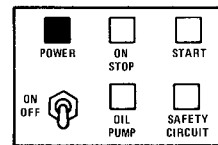

5. Start chilled water and condenser water pumps. Press ON-STOP button (light goes on).

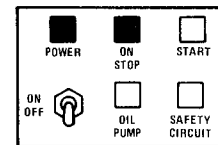

6. Turn on OIL-PUMP switch for several seconds. Pump should raise oil pressure 25 to 27 psi above refrigerant pressure at machine shutdown condition. SAFETY CIRCUIT light should go on. If oil pump operates but SAFETY CIRCUIT light is out, check water flow switches.

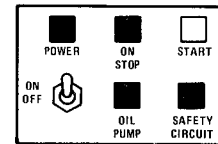

7. Turn off OIL PUMP switch. SAFETY CIRCUIT light should go off.

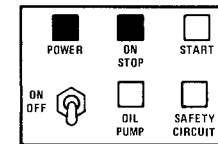

8. With OIL PUMP switch on, manually trip and reset water pump switches. SAFETY CIRCUIT light should go off as each switch is tripped. (Continuous operation of oil pump is unnecessary during these checks.)

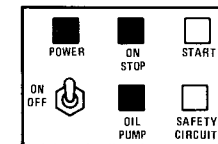

9. With OIL PUMP and ON-STOP switches on, and water pumps operating, press machine START button (gas or steam supply turned off)

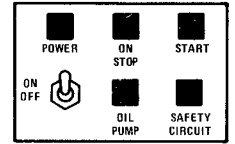

10. Turn off OIL PUMP switch. Oil pump must continue operating.

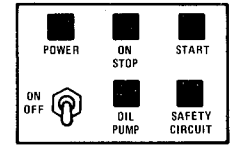

11. Open oil pump main disconnect. Driver circuit control must de-energize. Oil pump will remain on for 3 minutes.

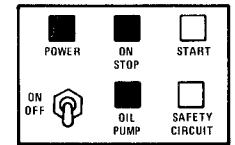

12. OIL PUMP light goes out.

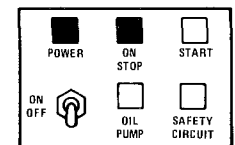

13. Press ON-STOP switch (light goes off).

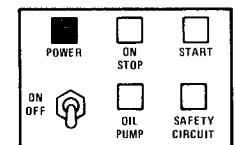

14. Remove all power. Restore gas or steam supply to drive. Restore power.

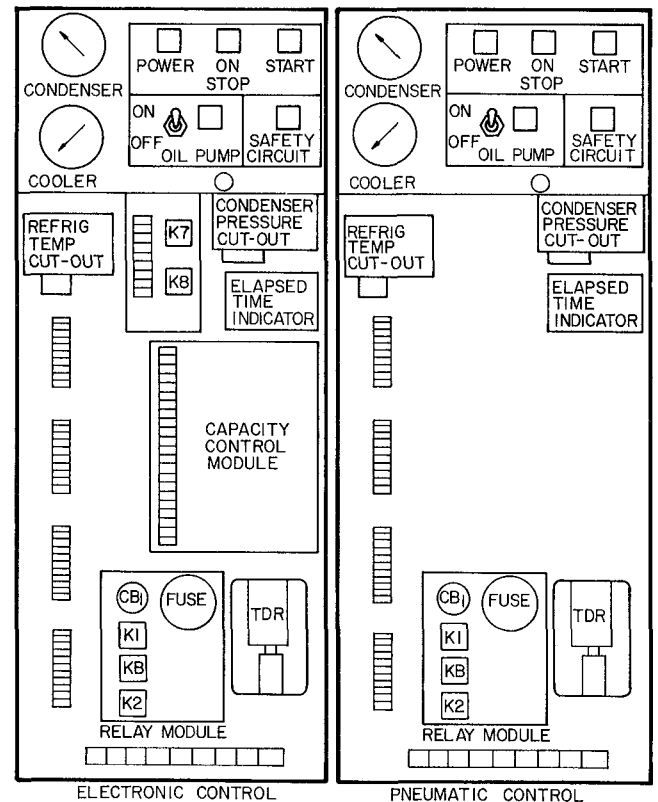

Fig. 7 – Control Center Components (Gas Engine or Turbine Drive)

START-UP

Preliminary Checks

1. Power on to circuit breakers, water pumps, cooling tower fans
2. Cooling tower water level
3. Refrigerant level
4. Oil reservoir level
5. Oil reservoir temperature 140 F or warmer
6. Oil cooler plug cock (item 16, Fig. 2) partially open, and any other valves in oil cooler line fully open
7. Valves in chilled water and condenser water circuits open and water circulating properly. *Do not permit water over 100 F to flow thru cooler.*
8. Air supply to pneumatic controls
9. Purge valves and switches in "Normal-Automatic" position. (Refer to chart attached to purge cover.)

Compressor Rotation and Operation

Electronic Control: Set capacity control switch to "Hold."

Pneumatic Control: Turn off supply air to chilled water thermostat and vane positioner.

Turn on OIL PUMP switch if gas engine or turbine drive. Press machine ON-STOP and START buttons (lights go on). As soon as the compressor shaft begins to turn, note direction of rotation. If *not* counterclockwise as viewed from drive end, stop compressor by pressing ON-STOP button (light goes out) and correct condition.

If rotation is counterclockwise, let compressor come up to speed and press ON-STOP button (light goes out). Listen for any unusual sounds as compressor coasts to a stop.

The program timer on electric drive units will allow compressor restart 15 minutes after stop.

Checking Safety Control Settings

While performing these checks, carefully monitor chilled water temperature to prevent freeze-up. Protection by safety controls cannot be assumed until all settings have been confirmed as follows.

Shut off gas or steam supply to engine or turbine. Open main disconnect (all power off to starter and controls).

Electronic Capacity Control: Set capacity control switch on "Hold."

Pneumatic Capacity Control: Ensure that pilot positioner operates as described in Setting Operating Controls – Pneumatic. If compressor has electric motor drive, set percent load knob on demand limit control at 100% and turn calibration screw fully clockwise.

Install jumpers across low refrigerant and low chilled water cutouts as follows:

Electric Motor Drive – 40 to 42; 10 to 11.

Gas Engine or Turbine Drive – 61 to 62; 71 to 72.

Close disconnects, start compressor and check oil pressure and temperature. With compressor running, operate the guide vanes with the capacity control switch or the pneumatic thermostat. *Do not exceed full load condition.*

1. Check controls 1 and 2 as indicated in Table 4.
2. Stop machine; open disconnects; remove jumpers; and check controls 3, 4 and 5 as indicated.

Table 4 – Setting Safety Controls

SAFETY OR CONTROL DEVICE	SAFETY OR CONTROL DEVICE
<p>1. Chilled Water Low-Temperature Cutout and Recycle Switch (Fig. 1).</p>  <ol style="list-style-type: none"> a. Set this switch to break at approximately 5 F below design chilled water temperature, or at 36 F whichever is higher b. Set the differential at 10 ± 1 F so that when the machine shuts down automatically at approximately 5 F below the design chilled water temperature it will restart at approximately 5 F above the design water temperature c. This control must break ahead of the refrigerant low-temperature cutout switch or the machine will not recycle automatically 	<p>2. Refrigerant Low-Temperature Cutout (Fig. 6 and 7)</p>  <p>Set refrigerant low-temperature cutout at 33 F or one degree below design refrigerant temperature, whichever is lower, while checking temperature at thermowell near control center</p>

Table 4 – Setting Safety Controls (cont)

SAFETY OR CONTROL DEVICE

STOP MACHINE, REMOVE JUMPERS AND PERFORM REMAINING CHECKS.

3. Condenser High-Pressure Cutout (Fig. 6 and 7).

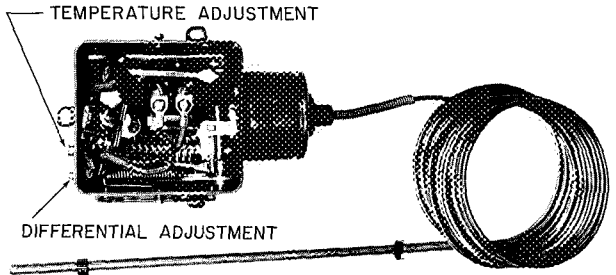
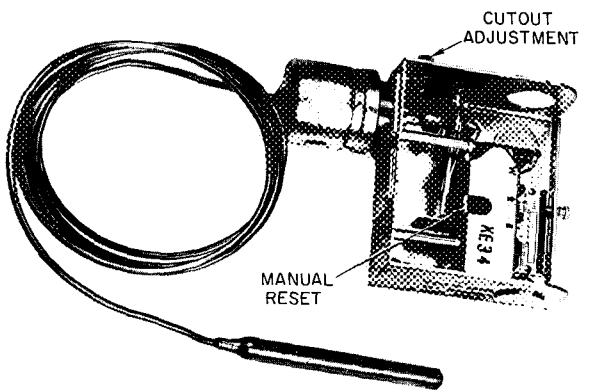
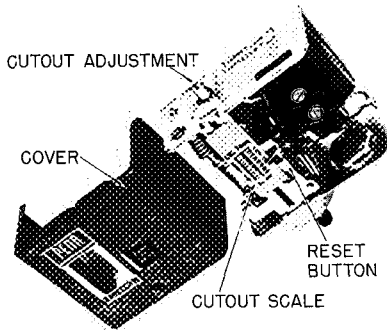

REFRIG	SETTING
11	15 psig
114	45 psig

The condenser high-pressure cutout is factory set to shut the machine down when condenser pressure reaches setting listed. Isolate the switch and check setting with a metered supply of air.

4. Oil Heater Thermostat (Fig. 2).

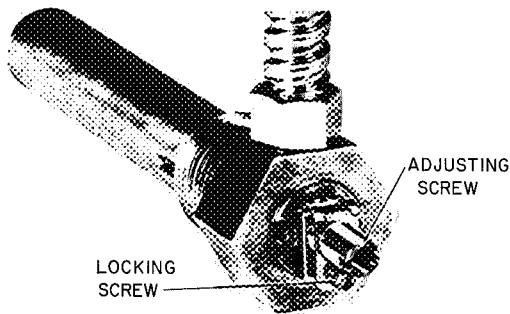

Set the oil heater thermostat to maintain a minimum oil reservoir temperature of 140 F at shutdown

5. Low Oil Pressure Cutout (Fig. 2).

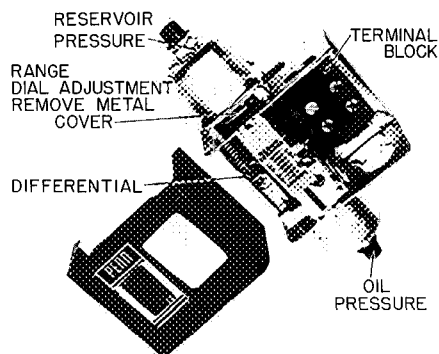

Low oil differential pressure switch is factory set to open at 11 ± 1 psi and close at 15 ± 1 psi differential pressure. Operate oil pump manually. Remove cap and gasket from regulating valve and loosen locknut. Turn adjusting screw counterclockwise to lower oil pressure to 11 psi differential. If safety does not trip, turn range dial clockwise until cutout occurs.

SAFETY OR CONTROL DEVICE

6. Oil Pressure Regulating Valve (Item 20, Fig. 2).

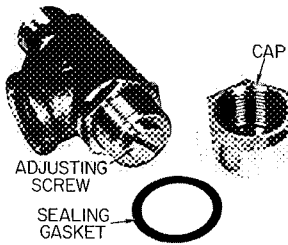

REFRIG	SETTING*
11	15 psid
114	15-20 psid

*Settings given are above reservoir pressure

Remove cap and washer and loosen locknut. Turn adjusting screw clockwise to raise oil pressure.

7. Vane Speed Valve (Electronic Machine Only)

Angle valve is located between oil line to main bearing and "F" and "G" solenoid valves (items 17 and 19, Fig. 2). Set valve at full open position.

8. Chilled Water Flow Switch

Field supplied and installed. Follow switch manufacturer's instructions for adjustment and maintenance.

9. Main Bearing Oil Temperature (item 11, Fig. 2)

During machine operation, gauge should read 150 to 165 F. Adjust water flow thru oil cooler with plug cock (item 16, Fig. 2). Do not exceed 7 gpm or pressure drop of 5 psig. Do not exceed 100 psi working pressure.

10. Dual Pressurestat for R-114 Pump-Down Compressor

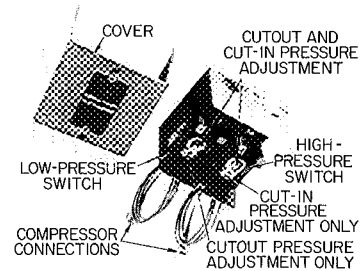

High-pressure switch to open on rise at 45 psig. Low-pressure switch to open on fall at 2.0 in. Hg vacuum.

Set high-pressure switch by operating compressor and throttling pump-down condenser water while watching pressure gauge.

Set low-pressure switch by operating compressor and gradually shutting suction valve while watching pressure gauge.

11. Oil Safety Switch for R-114 Pump-Down Compressor

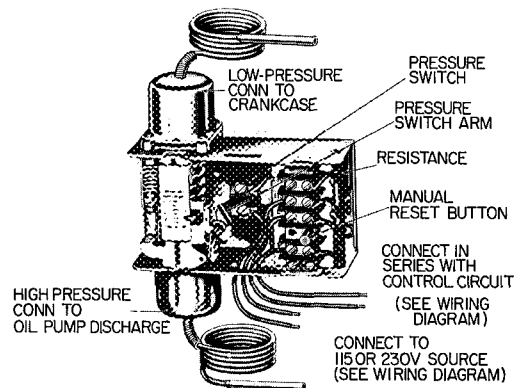

Contacts open on drop in oil pressure. Cutout 11-14 psi; cut-in 16-19 psi differential between pump discharge and compressor suction.

Preset switch with an external air source.

Setting Operating Controls – Electronic

MOTOR CURRENT CALIBRATION (Electronic Capacity Control/Motor Drive)

1. Establish a steady motor current value for this calibration. Open guide vanes manually (capacity control to “Inc”) until full load current is reached. Motor current calibration (Fig. 8) may need to be turned counterclockwise to permit vanes to open further. *Do not exceed 105% of nameplate full load amperes.*

If system load is sufficient to maintain full load current for a period of time, calibrate at this condition. With small loads, pull down to and maintain design leaving chilled water temperature (capacity control at “Hold”) and calibrate at this condition.

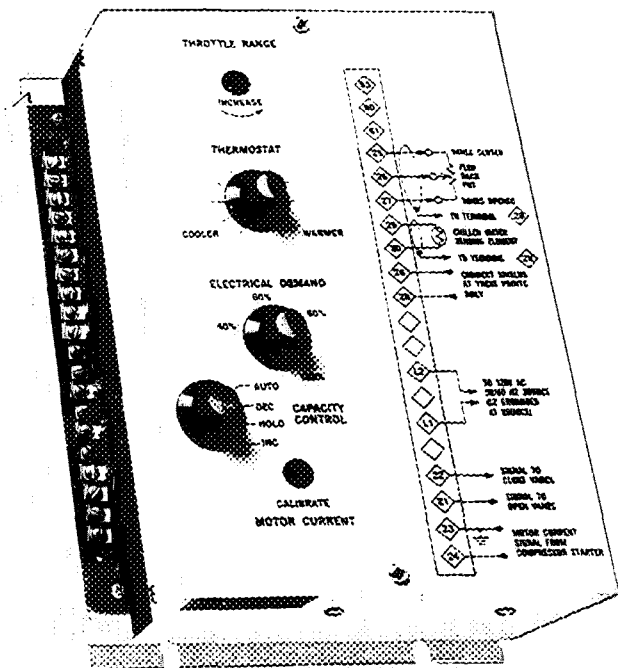

Fig. 8 – Capacity Control Module (Electric Motor Drive)

2. Measure motor current at selected condition. Determine its percentage of full load motor current.
3. Use this percentage figure to set the electrical demand adjustment (Fig. 8) per the following table:

Percent of Full Load Motor Current	Electrical Demand Adjustment Setting
105	100 percent
85 or above	80 percent
65 to 84	60 percent
45 to 64	40 percent
below 45	Control cannot be calibrated

4. Turn the motor current calibration adjustment fully clockwise. The guide vanes will close part way.

5. Turn the thermostat adjustment (Fig. 8) to COOLER (fully counterclockwise).
6. Set capacity control at “Inc” position.
7. Slowly turn the motor current calibration counterclockwise. Allow the guide vanes to open until motor current reaches 5% above the electrical demand setting.

NOTE: There is a time lag of several seconds due to feedback capacitance in the motor current circuit. When the motor current calibration setting is adjusted, allow for this time lag.

8. Check the foregoing motor current calibrations with machine under “Auto” control as follows:
 - a. Close vanes manually (capacity control to DEC).
 - b. Turn capacity control to AUTO. Vanes should stop opening at electrical demand setting.
9. If control was calibrated at less than 100% load, turn electrical demand adjustment setting to 100%. Control is now automatically calibrated for 100% full load current.
10. If control cannot be calibrated with above procedure, check voltage signal from signal resistor in starter. At 100% full load current, voltage between terminals 23 and 24 inside control center must be 0.5 ± 0.1 volts. If not in this range, check sizing of resistor in starter.

Both excess motor current and chilled water temperatures below the thermostat set point (Fig. 8) will override the capacity control setting. If the capacity control knob is in the “Inc” position, the guide vanes will stop opening. With the knob in any of the other positions, the vanes will close as needed.

The motor current limiting circuit operates in two steps.

At 100% full load motor current, the vanes will stop opening further. If the motor current should increase to 105% due to some change in load conditions, the vanes will close until the motor current is reduced to about 102%.

If the motor current is reduced to 98% or below, control again operates in response to chilled water temperature.

The electrical demand adjustment permits the operator to set the maximum current drawn by the motor and thus minimize the electrical demand rate during off-season operation.

CHILLED WATER CALIBRATION (Electronic Controls)

1. Turn throttle range adjustment (Fig. 8 and 9) fully clockwise.

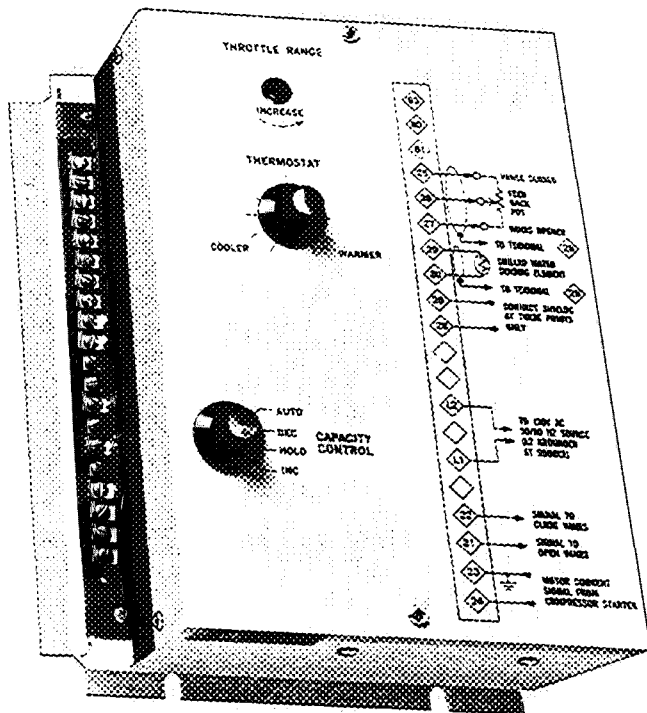

**Fig. 9 – Capacity Control Module
(Gas Engine or Turbine Drive)**

- Turn chilled water thermostat until design chilled water temperature is maintained. Mark thermostat at this position. If capacity control vanes hunt, turn throttle range adjustment counterclockwise in small increments until hunting ceases. Chilled water thermostat may require resetting.

Setting Operating Controls – Pneumatic

NOTE: If machine has special pneumatic controls, follow the instructions supplied in the job data for their setting and adjustment.

PILOT POSITIONER

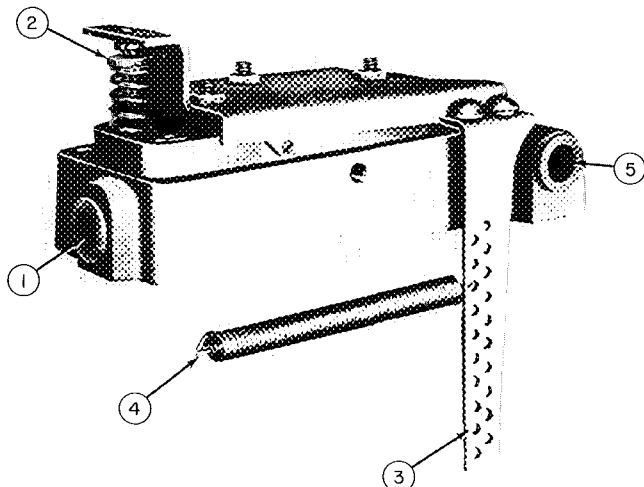

ITEM	DESCRIPTION
1	MAIN AIR CONNECTION (25 PSIG)
2	STARTING POINT ADJUSTMENT NUT
3	LEVER ARM
4	FOLLOWER SPRING
5	PILOT AIR CONNECTION (FROM CONTROL CENTER)

Preparation:

- Place jumper between terminals (L1) and (7).
- Open 25 lb air supply valve.
- Remove cover from pilot positioner.

Calibration:

Rotate dial on chilled water thermostat to vary pilot pressure. Observe pressure gage in pilot supply line near pilot positioner and adjust starting point nut (2) until piston operator (Fig. 4) begins to move at 5 psi pilot pressure. Place follower spring (4) in proper hole in level arm so that piston operator opens 100% at 15 psi pilot pressure.

Completion:

- Remove jumper from terminals (L1) and (7).
- Replace positioner cover.

ELECTRO-PNEUMATIC RELAY (Electric Motor Drive Only)

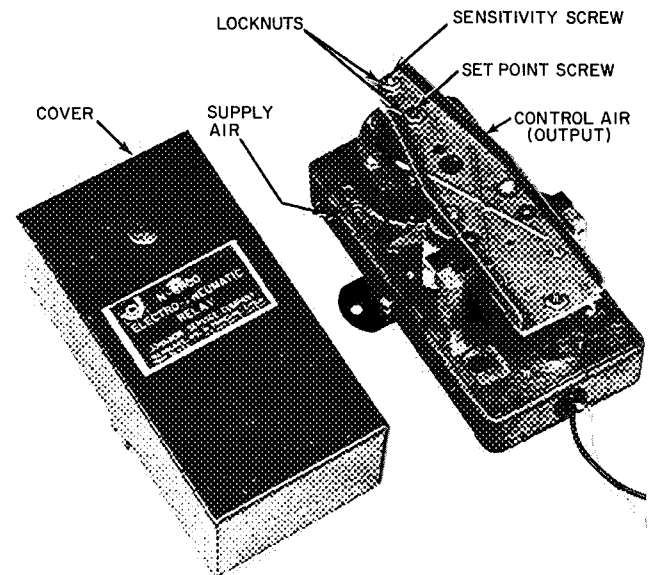

This control is factory calibrated to provide a linear output signal of 3 psi at 6 volts d-c to 18 psi at 15 volts d-c. Field recalibration should not be necessary.

If calibration is required:

- Establish 15 volt d-c input with 25 psi supply air.
- Turn sensitivity screw to obtain 18 psi or higher output.
- Adjust setpoint screw, if required, to set output at 18 ± 1/4 psi.
- Reduce input to 6 volts. Output should be 3 ± 1/4 psi. If low, turn sensitivity screw carefully clockwise. If high, turn screw counterclockwise.
- Re-check output at 15 volts. Repeat steps 3 and 4 if necessary.

DEMAND LIMIT CONTROL

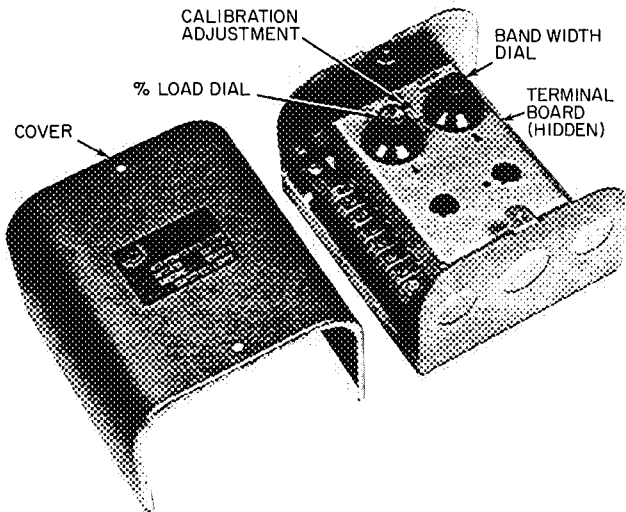

1. Set percent load dial at 100%.
2. Set Band Width dial at 3.
3. Turn Calibration Adjustment screw fully clockwise.
4. Run machine at 100% FLA by adjusting dial on chilled water thermostat.
5. Turn Calibration Adjustment screw counter-clockwise until guide vanes just begin to close.
6. If hunting occurs, increase band width and repeat steps 4 and 5.
7. If control cannot be calibrated with above procedure, check voltage signal from resistor in starter. At 100% full load, voltage between terminals 23 and 24 inside control center must be 3.0 ± 0.1 volts. If not in this range, check sizing of resistor in starter.

→ CHILLED WATER THERMOSTAT (PNEUMATIC)

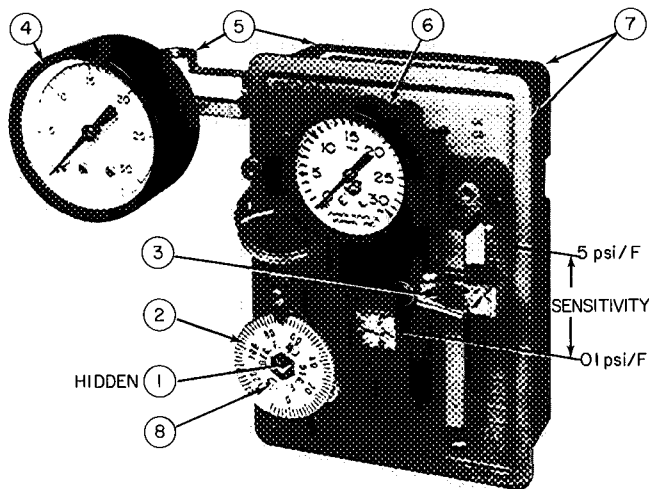

ITEM	DESCRIPTION
1	SET POINT ADJUSTING SCREW
2	THERMOSTAT DIAL
3	SENSITIVITY SLIDER
4	SUPPLY AIR PRESSURE GAGE
5	SUPPLY AIR CONNECTIONS
6	CONTROL AIR PRESSURE GAGE
7	CONTROL AIR CONNECTIONS
8	DIAL RETAINING SCREW (2)

Preparation:

1. Ensure 25 psi supply air to thermostat.
2. Loosen Allen setscrew in sensitivity slider and move slider halfway between midpoint and DA. Retighten screw.

Calibration:

1. Turn thermostat dial until control air registers 15 psi.
2. Operate machine to reach design chilled water temperature at design load. Maintain 15 psi control air during pulldown by adjusting thermostat dial as required.
3. On reaching design chilled water temperature, turn dial until control air pressure holds machine at design conditions.
4. Hold setpoint adjusting screw stationary within the dial post and set the thermostat dial at design chilled water temperature.

→ Completion:

If vane hunting occurs, move sensitivity slider away from DA. Sensitivity decreases as slider is moved from 5 psi/F to the lower limit of 0.1 psi/F.

Trimming Refrigerant Charge — After machine is placed in operation, it may be necessary to adjust the refrigerant charge to obtain optimum machine performance.

When machine full load is available, slowly add a sufficient amount of the remaining 200 lb of refrigerant until the difference between leaving chilled water temperature and cooler temperatures reaches design conditions or becomes a minimum. Shut down machine. Mark maximum refrigerant level. Maintain refrigerant at this level.

Hot Alignment Check — When all machine components have reached operating temperature (after running near full load for approximately two hours), a hot alignment check must be made.

1. Shut down machine.
2. Quickly disassemble couplings between compressor and drive (and gear, if used).
3. Check angular and parallel alignment in plan and elevation. Indicators may be mounted as in Fig. 10. Refer to coupling manufacturer's instructions and to Carrier Standard Service Techniques, Chapter 15, for applicable procedures.
4. After making adjustments, reassemble the couplings and run the machine until it reaches operating temperature.
5. Repeat steps 1 thru 3 until angular and parallel alignment is within coupling manufacturer's specified tolerances.

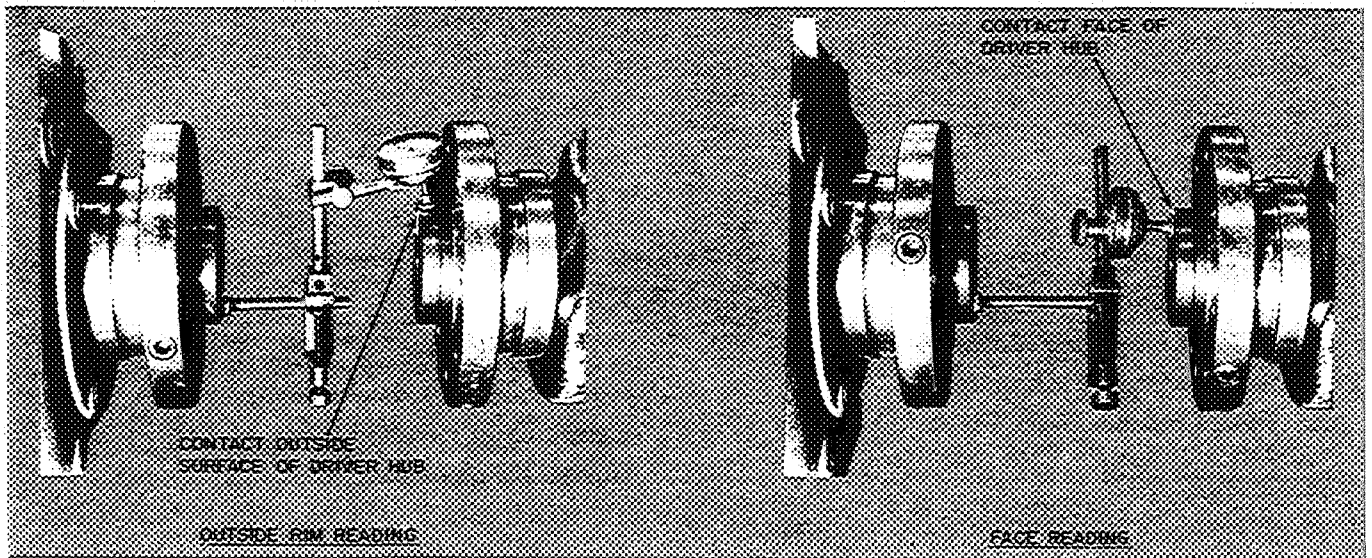

Fig. 10 – Checking Alignment with Dial Indicator

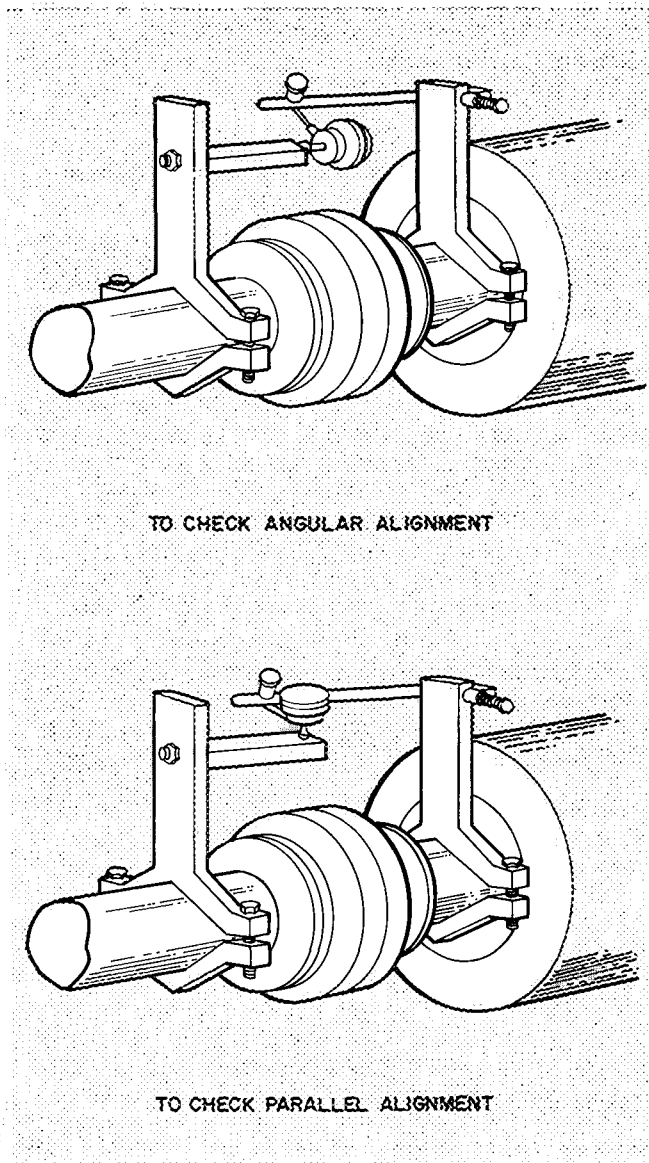

Fig. 11 – Alignment Check – Assembled Coupling

A second method of checking hot alignment can be used if there is room on the shafts between equipment and coupling to clamp a sturdy bracket. Clamping tool, Part No. TS-170, is available for this purpose thru Carrier Service Parts Department. Check with your local Carrier Office. Dial indicator must be obtained separately. Clamps must have space to rotate with the shaft. This method is quicker because couplings do not have to be disassembled. Mount brackets and dial indicators as in Fig. 11. Since both shafts are rotating together, concentricity and condition of the faces are not problems. The diameter used in the angular alignment formula is the circle thru which dial indicator rotates. This method is more accurate since the diameter is larger.

Doweling – After hot alignment is completed, the compressor, gear and drive must be doweled to their soleplates. This permits repositioning of components if they have to be moved. Compressor has four 3/4-in. holes for doweling.

1. Drill thru these holes into the soleplates. Ream holes with a tapered reamer with straight flutes.
2. Coat dowels with white lead or other lubricant to prevent rusting.
3. Tap dowels lightly into position with a small hammer. A ringing sound indicates the proper seating.

Repeat these steps with gear and drive, keeping dowels as vertical as possible. Dowel thru the four 3/4-in. holes on suction end of compressor base, the two feet on high speed end of gear, and the drive feet adjacent to gear. Refer to drive manufacturer's instructions for additional details on doweling this equipment.

INSTRUCTING THE CUSTOMER OPERATOR

Be sure the operator carefully reads and understands the 17CB Operating and Maintenance Instructions and any instructions on drive operation and maintenance.

Point out the following machine components, explain their function and that of the system in which they are used.

1. Compressor-Motor Assembly

- a. Guide Vanes, Vane Motor and Linkage

2. Cooler-Condenser-Economizer

- a. Float Chamber, Sight Glasses
- b. Thermowells
- c. Rupture Disc
- d. Refrigerant Charging Valve

3. Purge System

- a. Importance of Proper Operation
- b. Valves and System Operation
- c. Sight Glasses, Gage

4. Lubrication System

- a. Oil Pump, Cooler, Filter
- b. Solenoid Valve, Plug Cock
- c. Heater, Thermostat, Temperature Gage
- d. Pressure Regulating Valve
- e. Oil Level, Temperature

5. Control System

- a. Manual Switches (ON-STOP, START, OIL-PUMP)
- b. Gages and Lights
- c. Safety Controls
- d. Operating Controls
- e. Auxiliary and Special Controls

6. Auxiliary Equipment

- a. Starter(s)
- b. Pumps
- c. Cooling Tower
- d. Pumpout System (if supplied)

Describe Refrigeration Cycle

Review Maintenance

1. Scheduled
2. Extended Shutdown
3. Importance of Log Sheet
4. Importance of Water Treatment

Check Operator Knowledge

1. Start-Stop Procedure
2. Safety and Operating Controls

Discuss Carrier Service

1. Availability
2. Method of Ordering Parts

Review Operating and Maintenance Instructions

For replacement items use Carrier Specified Parts.

Manufacturer reserves the right to discontinue, or change at any time, specifications or designs without notice and without incurring obligations.