

# AW8D

**Motherboard  
Intel Pentium 4  
Socket 775**

## **User's Manual**



Introduction

Hardware Setup

BIOS Setup

Driver & Utility CD

Appendix

- LGA775 ATX Motherboard**

---

- NB: Intel 975X Chipset**

---

- SB: Intel ICH7R Chipset**

---

- 1066MHz FSB**

---

- Dual DDR2 800 DIMM Slots**

---

- Dual PCI-E X16 Graphics Slots**

---

- Dual GbE LAN**

---

- IEEE 1394**

---

- 6x SATA 3Gb/s**

---

- 7.1 Channel HD Audio**

---

- Silent OTES™ Technology**

---

- uGuru™ Technology**

---

### **About this Manual:**

This user's manual contains all the information you may need for setting up this motherboard. To read the user's manual of PDF format (readable by [Adobe Reader](#)), place the "Driver & Utility CD" into the CD-ROM drive in your system. The auto-run screen will appear, click the "Manual" tab to enter its submenu. If not, browse the root directory of the CD-ROM via the File Manager, and double click the "AUTORUN" file.

**AW8D**

User's Manual

English, 1<sup>st</sup> Edition

March 2006

**Copyright and Warranty Notice**

The information in this document is subject to change without notice and does not represent a commitment on part of the vendor, who assumes no liability or responsibility for any errors that may appear in this manual.

No warranty or representation, either expressed or implied, is made with respect to the quality, accuracy or fitness for any particular part of this document. In no event shall the manufacturer be liable for direct, indirect, special, incidental or consequential damages arising from any defect or error in this manual or product.

Product names appearing in this manual are for identification purpose only and trademarks and product names or brand names appearing in this document are the property of their respective owners.

This document contains materials protected under International Copyright Laws. All rights reserved. No part of this manual may be reproduced, transmitted or transcribed without the expressed written permission of the manufacturer and authors of this manual.

If you do not properly set the motherboard settings, causing the motherboard to malfunction or fail, we cannot guarantee any responsibility.

# Contents

---

<b>1. Introduction .....</b>	<b>1-1</b>
1.1 Features & Specifications .....	1-1
1.2 Motherboard Layout.....	1-3
<b>2. Hardware Setup .....</b>	<b>2-1</b>
2.1 Choosing a Computer Chassis.....	2-1
2.2 Installing Motherboard .....	2-1
2.3 Checking Jumper Settings .....	2-2
2.3.1 CMOS Memory Clearing Header and Backup Battery .....	2-3
2.3.2 Wake-up Header .....	2-5
2.4 Connecting Chassis Components.....	2-6
2.4.1 ATX Power Connectors .....	2-6
2.4.2 Front Panel Switches & Indicators Headers.....	2-7
2.4.3 FAN Power Connectors .....	2-8
2.5 Installing Hardware.....	2-9
2.5.1 CPU Socket 775 .....	2-9
2.5.2 DDR2 Memory Slots .....	2-12
2.5.3 Floppy and IDE Disk Drive Connectors .....	2-14
2.5.4 PCI Express X16 Add-on Slots .....	2-15
2.5.5 Serial ATA Connectors .....	2-17
2.5.6 AudioMAX Connection Slot .....	2-19
2.5.7 PCI Express X1 Add-on Slots .....	2-21
2.5.8 PCI Add-on Slot .....	2-21
2.6 Connecting Optional Devices .....	2-22
2.6.1 Additional USB 2.0 Port Headers.....	2-22
2.6.2 Additional IEEE1394 Port Header.....	2-23
2.7 Onboard Status Display .....	2-24
2.7.1 POST Code Displayer .....	2-24
2.7.2 Power Source Indicators .....	2-25
2.8 Connecting I/O Devices.....	2-26
<b>3. BIOS Setup.....</b>	<b>3-1</b>
3.1 $\mu$ Guru™ Utility.....	3-2
3.1.1 OC Guru .....	3-2
3.1.2 ABIT EQ .....	3-4
3.2 Standard CMOS Features.....	3-11
3.3 Advanced BIOS Features .....	3-14

3.4 Advanced Chipset Features.....	3-18
3.5 Integrated Peripherals.....	3-20
3.6 Power Management Setup.....	3-24
3.7 PnP/PCI Configurations .....	3-27
3.8 Load Fail-Safe Defaults .....	3-28
3.9 Load Optimized Defaults .....	3-28
3.10 Set Password.....	3-28
3.11 Save & Exit Setup .....	3-28
3.12 Exit Without Saving.....	3-28
<b>4. Driver &amp; Utility CD Support.....</b>	<b>4-1</b>
4.1 Intel Chipset Software Installation Utility .....	4-2
4.2 Intel Matrix Storage Technology Driver.....	4-3
4.3 Realtek Audio Driver .....	4-4
4.4 Realtek LAN Driver.....	4-5
4.5 Silicon Image 3132 SATA Driver.....	4-6
4.6 Silicon Image 3132 SATA RAID Driver .....	4-7
4.7 USB 2.0 Driver.....	4-8
4.8 ABIT µGuru Utility.....	4-8
<b>5. Appendix .....</b>	<b>5-1</b>
5.1 POST Code Definitions .....	5-1
5.1.1 AWARD POST Code Definitions.....	5-1
5.1.2 AC2005 POST Code Definitions.....	5-4
5.2 Troubleshooting (How to Get Technical Support?).....	5-5
5.2.1 Q & A.....	5-5
5.2.2 Technical Support Form .....	5-8
5.2.3 ABIT Contact Information .....	5-9

---

# 1. Introduction

## 1.1 Features & Specifications

### CPU

- Designed for Intel® Pentium 4 LGA775 processor with 1066/800 MHz FSB
- Supports Intel® Pentium Processor Extreme Edition & Intel® Pentium D Processor
- Supports Enhanced Intel Speedstep® Technology (EIST)
- Supports Intel® Extended Memory 64 Technology (EM64T)
- Supports Intel® Virtualization Technology
- Supports Intel® Execute Disable Bit capability
- Supports Intel® Hyper-Threading Technology

### Chipset

- Northbridge: Intel® 975X
- Southbridge: Intel® ICH7R

### Memory

- Four 240-pin DIMM slots
- Supports Dual Channel DDR2 800 Un-buffered Non-ECC memory
- Supports maximum memory capacity up to 8GB

### Graphics

- Supports Dual PCI-Express X16 slots (Dual ATI CrossFire VGA cards)

### ABIT Engineered

- ABIT uGuru™ Technology
- ABIT Silent OTES™ Technology
- ABIT AudioMAX Technology

### Serial ATA

- Intel® Matrix Storage Technology supports RAID 0, 1, 10, 5
- Supports SATA AHCI, providing native command queuing and native hot plug
- Onboard Silicon Image Sil3132 PCIE SATA 3G RAID controller

### LAN

- Onboard dual PCI-E Gigabit LAN controller supports 10/100/1000Mb Ethernet

### IEEE 1394

- Supports 2 Ports IEEE 1394 at 400Mb/s transfer rate

### Audio

- ABIT AudioMAX HD 7.1 CH
- Supports auto jack sensing and optical S/PDIF In/Out
- Dolby Master Studio Certificated

## **Expansion Slots**

- 2x PCI-E X16 slots
- 2x PCI-E X1 slots
- 1x PCI slot
- 1x AudioMAX slot

## **Internal I/O Connectors**

- 1x Floppy port
- 1x UDMA 100/66/33 connector
- 6x SATA connectors
- 2x USB 2.0 headers
- 1x IEEE1394 header

## **Rear Panel I/O**

- ABIT Silent OTES™
- 1x PS/2 Keyboard connector
- 1x PS/2 Mouse connector
- 1x IEEE1394 connector
- 4x USB 2.0 connectors
- 2x RJ-45 Gigabit LAN connectors

## **Miscellaneous**

- ATX form factor (305mm x 245mm)

※ **Specifications and information contained herein are subject to change without notice.**







## 2. Hardware Setup

In this chapter we will elaborate all the information you need upon installing this motherboard to your computer system.

- ✘ **Always power off the computer and unplug the AC power cord before adding or removing any peripheral or component. Failing to do so may cause severe damage to your motherboard and/or peripherals. Plug in the AC power cord only after you have carefully checked everything.**

### 2.1 Choosing a Computer Chassis

- This motherboard carries an ATX form factor of 305 x 245 mm. Choose a chassis big enough to install this motherboard.
- As some features for this motherboard are implemented by cabling connectors on the motherboard to indicators and switches or buttons on the chassis, make sure your chassis supports all the features required.
- If there is possibility of adopting some more hard drives, make sure your chassis has sufficient power and space for them.
- Most chassis have alternatives for I/O shield located at the rear panel. Make sure the I/O shield of the chassis matches the I/O port configuration of this motherboard. You can find an I/O shield specifically designed for this motherboard in its package.

### 2.2 Installing Motherboard

Most computer chassis have a base with many mounting holes to allow the motherboard to be securely attached, and at the same time, prevent the system from short circuits. There are two ways to attach the motherboard to the chassis base:

1. use studs, or
2. use spacers

In principle, the best way to attach the board is to use studs. Only if you are unable to do this should you attach the board with spacers.

Line up the holes on the board with the mounting holes on the chassis. If the holes line up and there are screw holes, you can attach the board with studs. If the holes line up and there are only slots, you can only attach with spacers. Take the tip of the spacers and insert them into the slots. After doing this to all the slots, you can slide the board into position aligned with slots. After the board has been positioned, check to make sure everything is OK before putting the chassis back on.

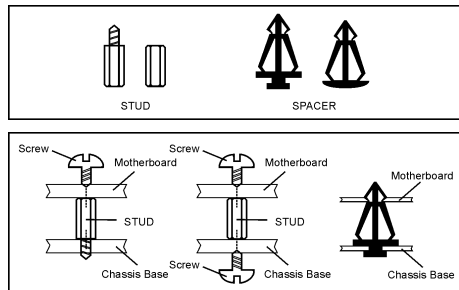

### To install this motherboard:

1. Locate all the screw holes on the motherboard and the chassis base.
2. Place all the studs or spacers needed on the chassis base and have them tightened.
3. Face the motherboard's I/O ports toward the chassis's rear panel.
4. Line up all the motherboard's screw holes with those studs or spacers on the chassis.
5. Install the motherboard with screws and have them tightened.

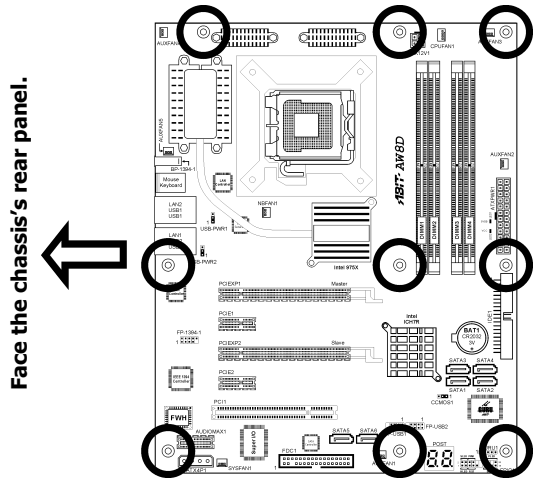

※ To prevent shorting the PCB circuit, please REMOVE the metal studs or spacers if they are already fastened on the chassis base and are without mounting-holes on the motherboard to align with.

## 2.3 Checking Jumper Settings

For a 2-pin jumper, plug the jumper cap on both pins will make it CLOSE (SHORT). Remove the jumper cap, or plug it on either pin (reserved for future use) will leave it at OPEN position.

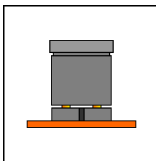

SHORT

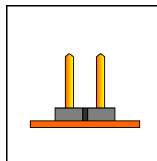

OPEN

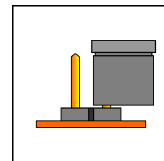

OPEN

For 3-pin jumper, pin 1~2 or pin 2~3 can be shorted by plugging the jumper cap in.

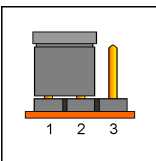

Pin 1~2 SHORT

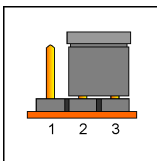

Pin 2~3 SHORT

### 2.3.1 CMOS Memory Clearing Header and Backup Battery

The time to clear the CMOS memory occurs when (a) the CMOS data becomes corrupted, (b) you forgot the supervisor or user password preset in the BIOS menu, (c) you are unable to boot-up the system because the CPU ratio/clock was incorrectly set in the BIOS menu.

This header uses a jumper cap to clear the CMOS memory and have it reconfigured to the default values stored in BIOS.

- **Pins 1 and 2 shorted (default):** Normal operation.
- **Pins 2 and 3 shorted:** Clear CMOS memory.

#### To clear the CMOS memory and load in the default values:

1. Power off the system.
2. Set pin 2 and pin 3 shorted by the jumper cap. Wait for a few seconds. Set the jumper cap back to its default settings --- pin 1 and pin 2 shorted.
3. Power on the system.
4. For incorrect CPU ratio/clock settings in the BIOS, press <Del> key to enter the BIOS setup menu right after powering on system.
5. Set the CPU operating speed back to its default or an appropriate value.
6. Save and exit the BIOS setup menu.

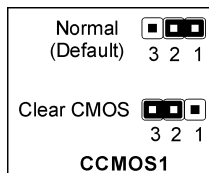
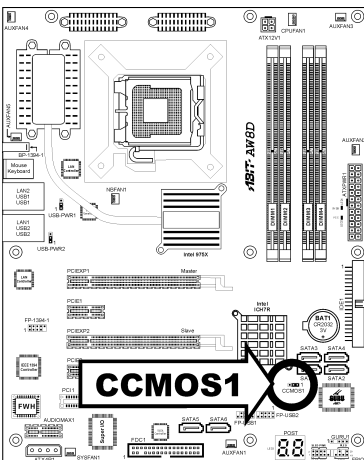



### 2.3.2 Wake-up Header

These headers use a jumper cap to enable/disable the wake-up function.

- USB-PWR1:**  
 Pin 1-2 shorted (default): Disable wake-up function support at USB1 port.  
 Pin 2-3 shorted: Enable wake-up function support at USB1 port.
- USB-PWR2:**  
 Pin 1-2 shorted (default): Disable wake-up function support at USB2 port.  
 Pin 2-3 shorted: Enable wake-up function support at USB2 port

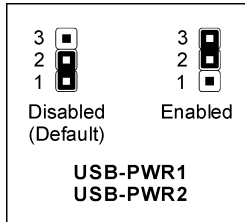
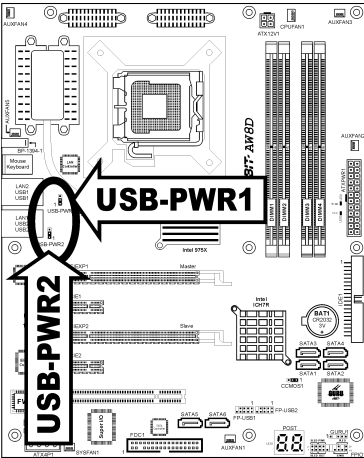

## 2.4 Connecting Chassis Components

### 2.4.1 ATX Power Connectors

These connectors provide the connection from an ATX power supply. As the plugs from the power supply fit in only one orientation, find the correct one and push firmly down into these connectors.

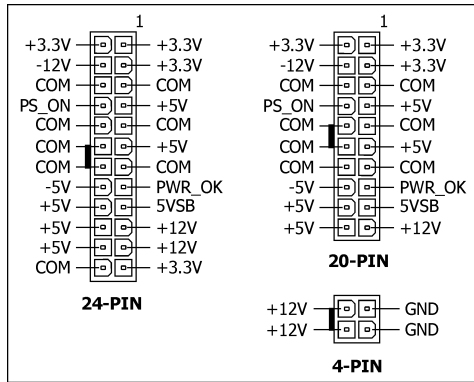
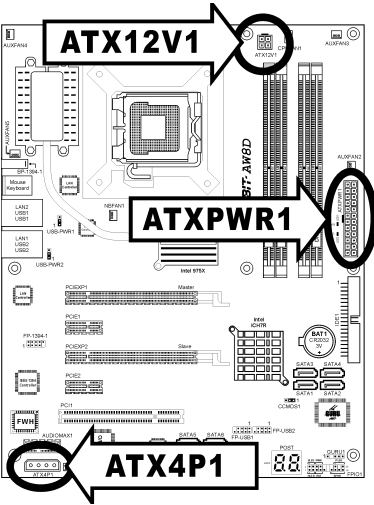

#### ATX 24-Pin Power Connector:

The power supply with 20-pin or 24-pin cables can both be connected to this 24-pin connector. Connect from pin-1 for either type. However, a 20-pin power supply may cause the system unstable or even unbootable for the sake of insufficient electricity. A minimum power of 300W or higher is recommended.

#### ATX 12V 4-Pin Power Connector:

This connector supplies power to CPU. The system will not start without connecting power to this one.

#### Auxiliary 12V Power Connector:

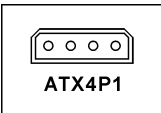

This connector provides an auxiliary power source for devices added on PCI Express slots.

## 2.4.2 Front Panel Switches & Indicators Headers

This header is used for connecting switches and LED indicators on the chassis front panel.

Watch the power LED pin position and orientation. The mark "+" align to the pin in the figure below stands for positive polarity for the LED connection. Please pay attention to connect these headers. A wrong orientation will only cause the LED not lighting, but a wrong connection of the switches could cause system malfunction.

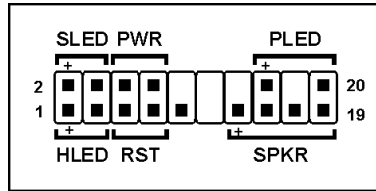
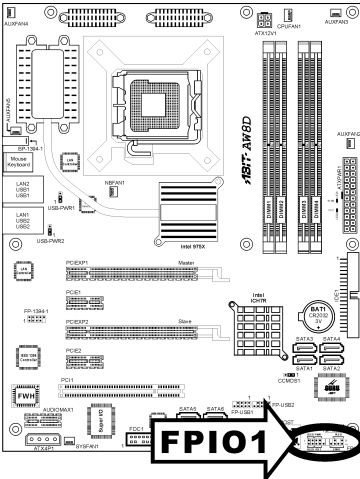

- **HLED (Pin 1, 3):**  
Connects to the HDD LED cable of chassis front panel.
- **RST (Pin 5, 7):**  
Connects to the Reset Switch cable of chassis front panel.
- **SPKR (Pin 13, 15, 17, 19):**  
Connects to the System Speaker cable of chassis.
- **SLED (Pin 2, 4):**  
Connects to the Suspend LED cable (if there is one) of chassis front panel.
- **PWR (Pin 6, 8):**  
Connects to the Power Switch cable of chassis front panel.
- **PLED (Pin 16, 18, 20):**  
Connects to the Power LED cable of chassis front panel.

### 2.4.3 FAN Power Connectors

These connectors each provide power to the cooling fans installed in your system.

- **CPUFAN1:** CPU Fan Power Connector
- **NBFAN1:** Chipset Fan Power Connector
- **SYSFAN1:** System Fan Power Connector
- **AUXFAN1~5:** Auxiliary Fan Power Connector

※ These fan connectors are not jumpers. DO NOT place jumper caps on these connectors.

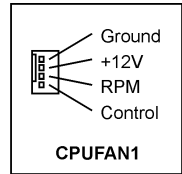
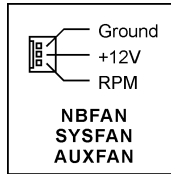
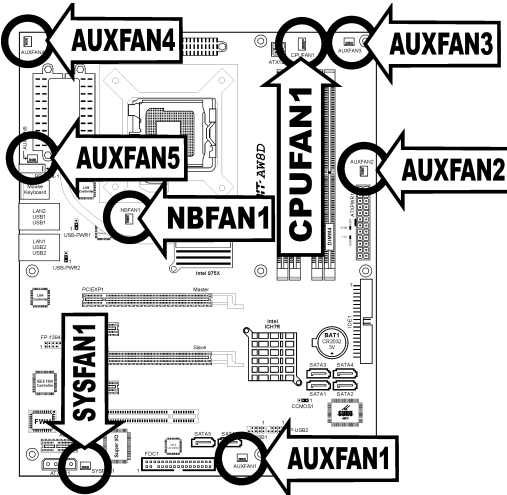



## 2.5 Installing Hardware

- ※ **DO NOT** scratch the motherboard when installing hardware. An accidentally scratch of a tiny surface-mount component may seriously damage the motherboard.
- ※ **In order to protect the contact pins, please pay attention to these notices:**
  1. A maximum 20 cycles of CPU installation is recommended.
  2. Never touch the contact pins with fingers or any object.
  3. Always put on the cap when the CPU is not in use.

### 2.5.1 CPU Socket 775

1. Place the board so as to let the lever-hook of the socket is on your left side. Use your left thumb and forefinger to hold the lever hook, pull it away from the retention tab. Rotate the lever to fully open position.



2. Use your right thumb on the bottom-right side of the load plate and lift it up to fully open position.

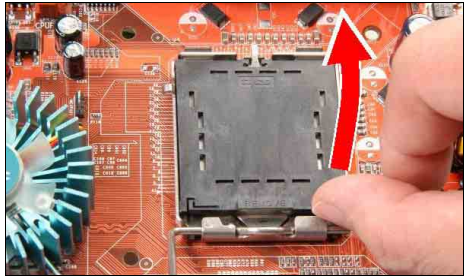

3. Use your right thumb and forefinger to grasp the CPU package. Be sure to grasp on the edge of the substrate, and face the Pin-1 indicator toward the bottom-left side. Aim at the socket and place the CPU package vertical down into the socket.

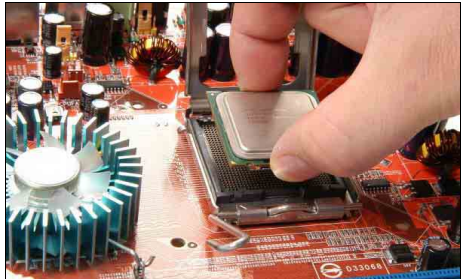

4. Visually inspect if the CPU is seated well into the socket. The alignment key must be located in the notch of package.

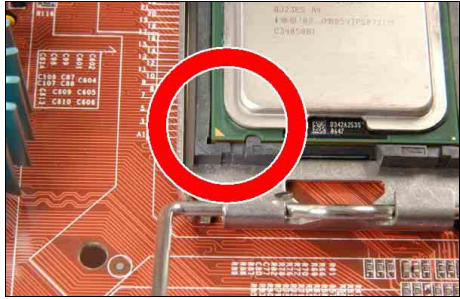

5. Use your left hand to hold the load plate, and use your right thumb to peel the cap off.

※ **The cap plays an important role in protecting contact pins. In order to prevent bent pin, PUT ON the cap after operation or testing.**

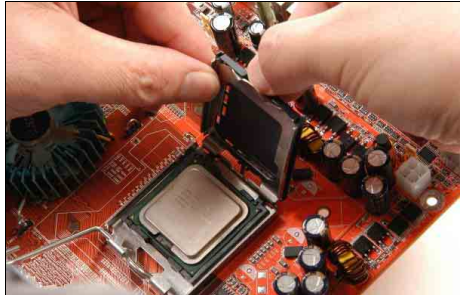

6. Lower the plate onto the CPU package. Engage the load lever while gently pressing down the load plate.



7. Secure the lever with the hook under retention tab.



- Place the heatsink and fan assembly onto the socket. Align the four fasteners toward the four mounting holes on the motherboard.



- Press each of the four fasteners down into the mounting holes. Rotate the fastener clock-wise to lock the heatsink and fan assembly into position.

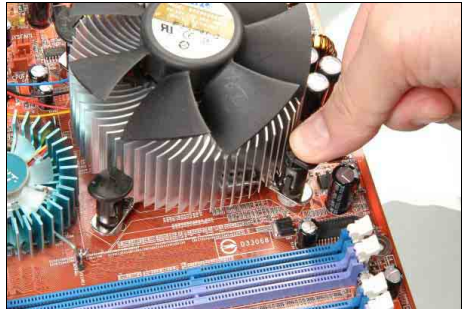

- Attach the four-pin power plug from the heatsink and fan assembly to the CPU FAN connector.

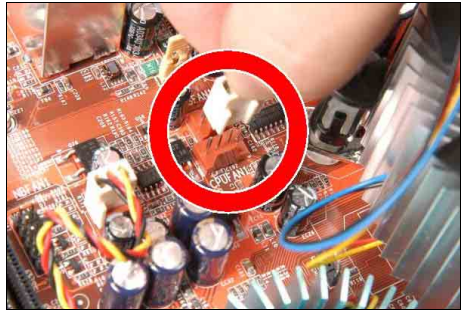

- ※ The installation procedures vary with different types of CPU fan-and-heatsink assembly. The one shown here is served for demo only. For detailed information on how to install the one you bought, refer to its installation guidelines.
- ※ A higher fan speed will be helpful for better airflow and heat-dissipation. Nevertheless, stay alert to touch any heatsink since the high temperature generated by the working system is still possible.

## 2.5.2 DDR2 Memory Slots

This motherboard provides four 240-pin DIMM slots for Dual Channel DDR2 800/667/533 memory modules with memory expansion size up to 8GB.

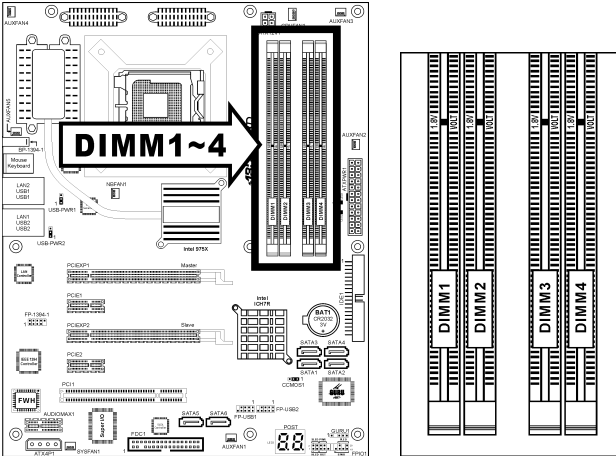

- To reach the optimum performance in dual-channel configurations, install identical DDR2 DIMM pairs for each channel.
- Install DIMMs with the same CAS latency. To reach the optimum compatibility, obtain memory modules from the same vendor.
- Due to chipset resource allocation, the system may detect less than 4GB of system memory in the installation of four 1GB DDR2 memory modules.
- Due to chipset limitation, 128MB DIMM modules or double-sided x16 memory chips are not supported.

There are several methods of different DDR2 configurations depending on how the DIMMs are populated on each system memory channel:

- **[Single Channel]:** only one channel is populated.

Method	Channel A		Channel B	
	DIMM1	DIMM2	DIMM3	DIMM4
1	512MB	-	-	-
2	-	512MB	-	-
3	-	-	512MB	-
4	-	-	-	512MB
5	512MB	512MB	-	-
6	-	-	512MB	512MB

- **[Dual Channel Asymmetric]:** both channels are populated, but each channel has a different amount of total memory. (Channel A ≠ Channel B)

Method	Channel A		Channel B	
	DIMM1	DIMM2	DIMM3	DIMM4
1	512MB	-	256MB	-
2	-	256MB	-	512MB
3	512MB	-	-	256MB
4	-	256MB	512MB	-
5	256MB	256MB	256MB	-
6	256MB	256MB	-	256MB
7	256MB	-	256MB	256MB
8	-	256MB	256MB	256MB
9	256MB	256MB	512MB	512MB
10	256MB	256MB	256MB	512MB

- **[Dual Channel Symmetric]:** both channels are populated where each channel has the same amount of total memory. (Channel A = Channel B)

Method	Channel A		Channel B	
	DIMM1	DIMM2	DIMM3	DIMM4
1	512MB	-	512MB	-
2	-	512MB	-	512MB
3	512MB	-	-	512MB
4	-	512MB	512MB	-
5	256MB	256MB	512MB	-
6	256MB	256MB	-	512MB
7	512MB	-	256MB	256MB
8	-	512MB	256MB	256MB
9	512MB	256MB	512MB	256MB
10	256MB	512MB	256MB	512MB

Power off the computer and unplug the AC power cord before installing or removing memory modules.

1. Locate the DIMM slot on the board.
2. Hold two edges of the DIMM module carefully, keep away of touching its connectors.
3. Align the notch key on the module with the rib on the slot.
4. Firmly press the module into the slots until the ejector tabs at both sides of the slot automatically snaps into the mounting notch. Do not force the DIMM module in with extra force as the DIMM module only fit in one direction.
5. To remove the DIMM modules, push the two ejector tabs on the slot outward simultaneously, and then pull out the DIMM module.

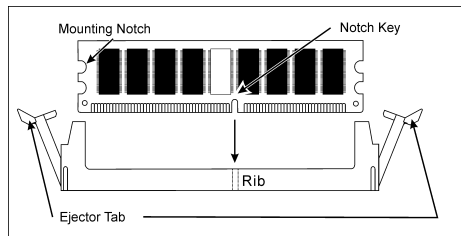

※ **Static electricity can damage the electronic components of the computer or optional boards. Before starting these procedures, ensure that you are discharged of static electricity by touching a grounded metal object briefly.**

## 2.5.3 Floppy and IDE Disk Drive Connectors

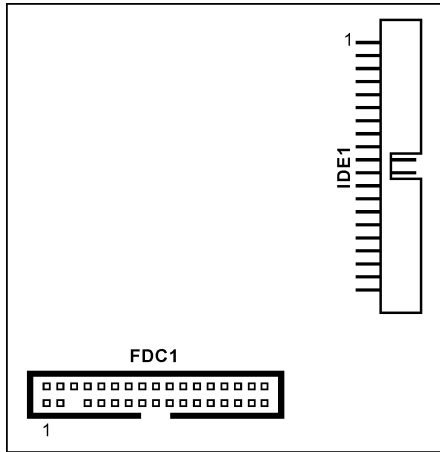
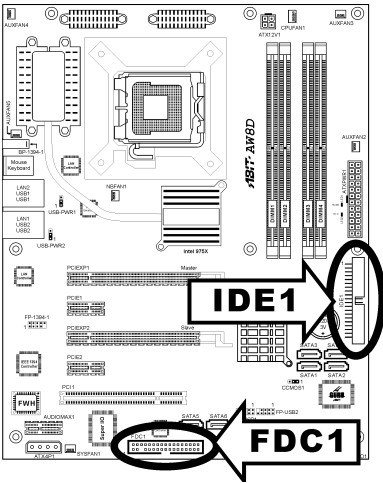

The FDC1 connector connects up to two floppy drives with a 34-wire, 2-connector floppy cable. Connect the single end at the longer length of ribbon cable to the FDC1 on the board, the two connectors on the other end to the floppy disk drives connector. Generally you need only one floppy disk drive in your system.

- ❖ **The red line on the ribbon cable must be aligned with pin-1 on both the FDC1 port and the floppy connector.**

Each of the IDE port connects up to two IDE drives at Ultra ATA/100 mode by one 40-pin, 80-conductor, and 3-connector Ultra ATA/66 ribbon cables.

Connect the single end (blue connector) at the longer length of ribbon cable to the IDE port of this board, the other two ends (gray and black connector) at the shorter length of the ribbon cable to the connectors of your hard drives.

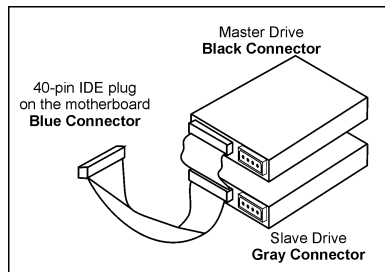

- ❖ **Make sure to configure the "Master" and "Slave" relation before connecting two drives by one single ribbon cable. The red line on the ribbon cable must be aligned with pin-1 on both the IDE port and the hard-drive connector.**

## 2.5.4 PCI Express X16 Add-on Slots

These slots support the connections of graphics cards that comply with PCI Express specifications. This motherboard provides dual PCI-Express X16 slots for one or two graphics cards installation:

### One PCIE graphics card installation (Normal Mode):

Install one PCIE graphics card into [Master] slot (the **PCIEXP1** slot on this motherboard).

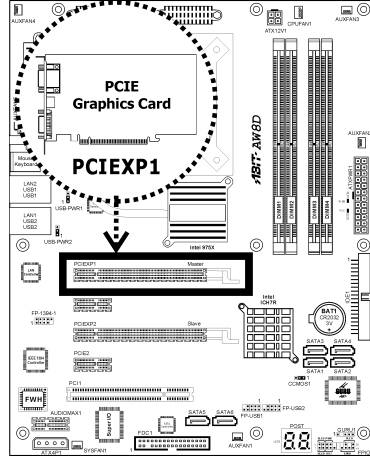

### Two PCIE graphics cards installation (CrossFire Mode):

Install one CrossFire™ Edition graphics card into [Master] slot (the **PCIEXP1** slot on this motherboard), and one CrossFire™ Compatible graphics card into [Slave] slot (the **PCIEXP2** slot on this motherboard).

※ **The ATI CrossFire™ technology currently supports the Microsoft Windows XP with Service Pack 2 only.**

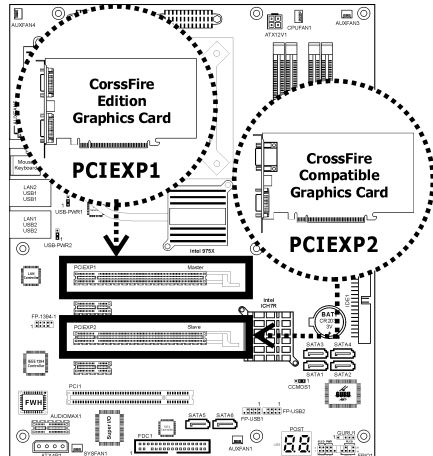

To enable CrossFire Mode, you will need to:

- Prepare one CrossFire™ Edition graphics card and one CrossFire™ Compatible graphics card.
- Make sure the graphics card driver supports the ATI CrossFire™ technology. Download the latest driver from ATI website (<http://www.ati.com>).
- Make sure your power supply unit is sufficient to provide the minimum power required.

1. Insert the CrossFire™ Edition graphics card [Master Card] into the [PCIEXP1] master slot on motherboard.
2. Insert the CrossFire™ compatible PCI Express graphics card (Slave Card) into the [PCIEXP2] slave slot.

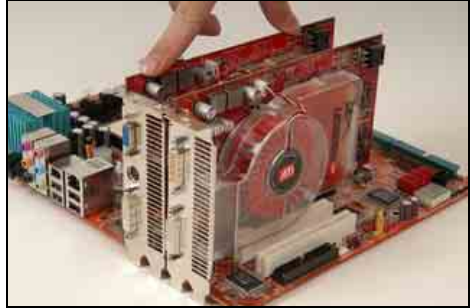

3. There are 3 connectors on the DMS-59™-to-interconnect cable:

Connector 1: [DMS-59™] Male connector

Connector 2: [DVI-I] Female connector

Connector 3: [DVI-I] Male connector

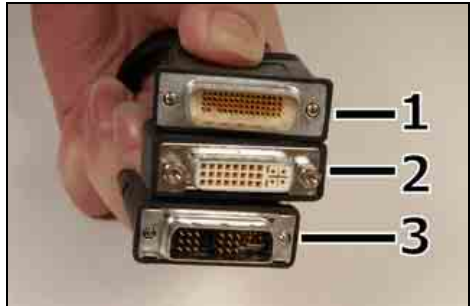

4. Connect the DMS-59™ Male plug to the DMS-59™ connector on Master Card.
5. Connect the DVI-I Male-end to the DVI-I connector on Slave Card.
6. Connect the video output to your monitor from the remaining DVI-I Female-end.



※ **The motherboard in this illustration is served for demonstration only, may not be the same type or model as the one described in this user's manual.**



## 2.5.5 Serial ATA Connectors

Each SATA connector serves as one single channel to connect one SATA device by a thin SATA cable.

The disk array for RAID configuration is also provided through these SATA connectors:

- **SATA1~SATA4:** Available for RAID 0, RAID 1, RAID 5, or RAID 10 configuration by the utility "Intel Matrix Storage Manager".
- **SATA5~SATA6:** Available for RAID 0 or RAID 1 configuration by the utility "Sil3132 SATA RAID Driver".

For more information on how to configure the function mode for SATA, please refer to the item "On-Chip SATA" in the BIOS menu of "On-Chip IDE Device".

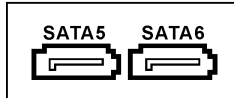
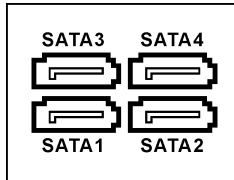
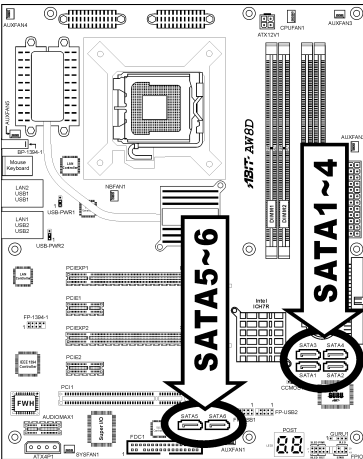

SATA signal cable (optional)



SATA power cable (optional)

### To connect SATA device:

1. Attach either end of the signal cable to the SATA connector on motherboard. Attach the other end to SATA device.
2. Attach the SATA power cable to the SATA device and connect the other end from the power supply.

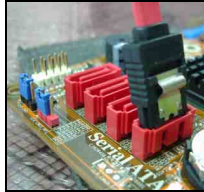

### To convert between PATA and SATA:

The optional "SERILLEL" is a convenient accessory to convert between parallel and serial devices for this type of motherboard designed with the SATA controller from Silicon Image.



## 2.5.6 AudioMAX Connection Slot

This slot provides the audio input/output connection over the rear I/O part through an add-on daughter-card. Find your "AudioMAX" daughter-card and its driver in the motherboard package.

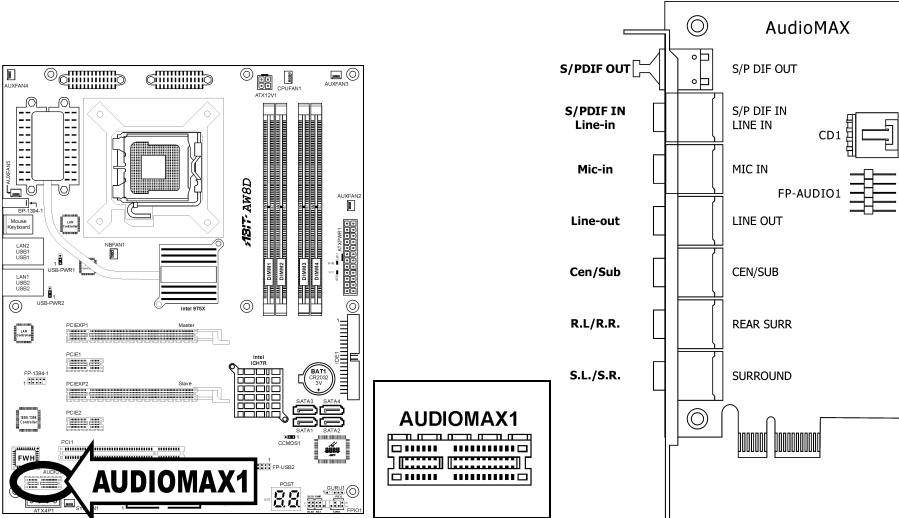

- **S/PDIF Out:** This connector provides an S/PDIF-Out connection through optical fiber to digital multimedia devices.
- **S/PDIF In:** This connector provides an S/PDIF-In connection through optical fiber to digital multimedia devices.
- **Line-In:** Connects to the line out from external audio sources.
- **Mic-In:** Connects to the plug from external microphone.
- **Line-Out:** Connects to the front left and front right channel in the 7.1-channel or regular 2-channel audio system.
- **Cen/Sub:** Connects to the center and subwoofer channel in the 7.1-channel audio system.
- **R.L./R.R. (Rear Left / Rear Right):** Connects to the rear left and rear right channel in the 7.1-channel audio system.
- **S.L./S.R. (Surround Left / Surround Right):** Connects to the surround left and surround right channel in the 7.1-channel audio system.
- **CD1:** This connector connects to the audio output of internal CD-ROM drive or add-on card.

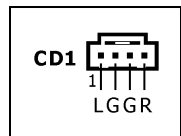

- **FP-AUDIO1:** This header provides the connection to audio connector at front panel.

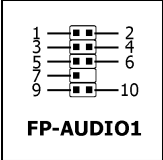
 <b>FP-AUDIO1</b>		Pin	Pin Assignment	Pin	Pin Assignment
		1	MIC2 L	2	AGND
		3	MIC2 R	4	AVCC
		5	FRO-R	6	MIC2_JD
		7	F_IO_SEN	8	
		9	FRO-L	10	LINE2_JD

### S/PDIF Connection:

In the motherboard package you can find one audio daughter-card and one optical-fiber cable.

- S/PDIF Input Connection:
  1. Remove the rubber protection-cap. Attach one end of the optical cable with the 3.5mm Optical-to-Stereo adapter, and have it plugged into the [Line-In] jack on this daughter-card. (This jack is served for either optical or line input.)
  2. Connect the other end of the optical cable to the [Digital-Out] (SPDIF-Out) jack on your digital multimedia device.
- S/PDIF Output Connection:
  1. Remove the rubber protection-cap. Plug one end of the optical cable into the [SPDIF-Out] jack on this daughter-card.
  2. Connect the other end of the optical cable to the [Digital-In] (SPDIF-In) jack on your digital multimedia device.

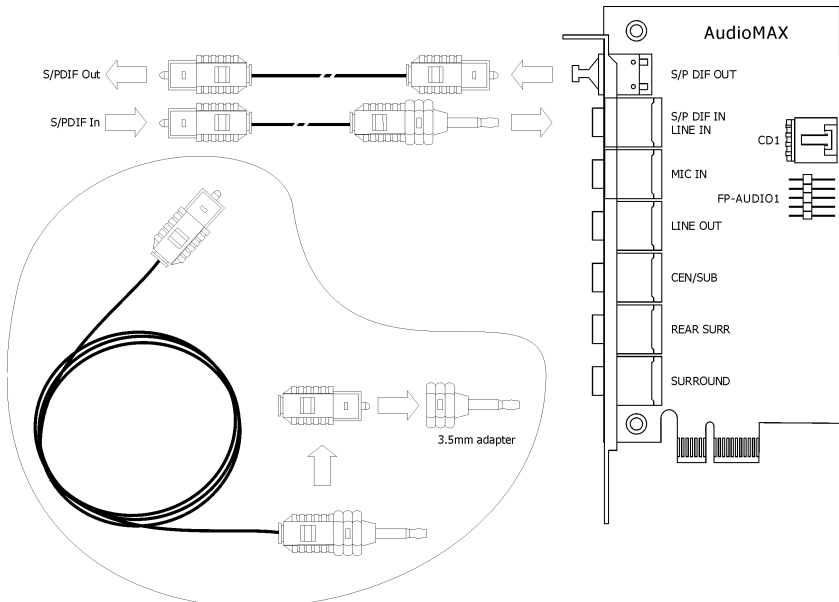

## 2.5.7 PCI Express X1 Add-on Slots

These slots provide the connection of add-on cards that comply with PCI Express specifications.

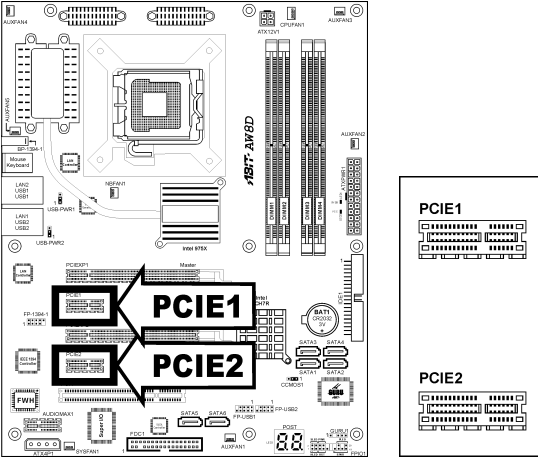

## 2.5.8 PCI Add-on Slot

This motherboard remains one standard PCI slot for the add-on card of PCI compliant.

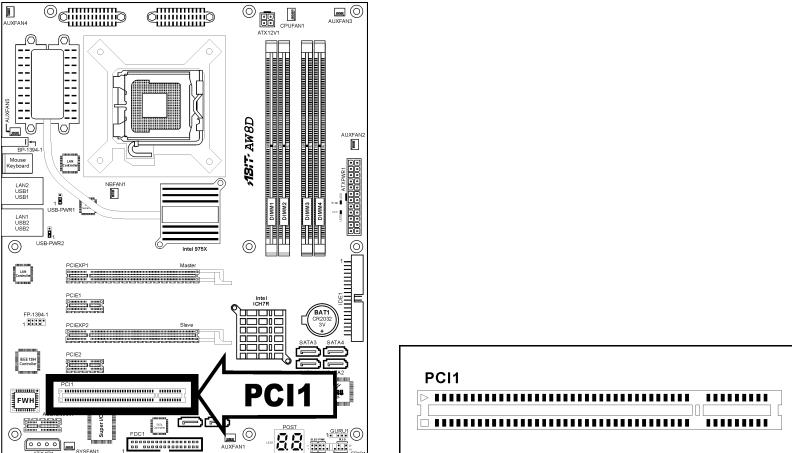

## 2.6 Connecting Optional Devices

### 2.6.1 Additional USB 2.0 Port Headers

Besides the 4x USB 2.0 ports located at rear I/O part, this motherboard also features 2x more USB 2.0 headers onboard. Each header supports 2x additional USB 2.0 ports by connecting bracket or cable to the rear I/O panel or the front-mounted USB ports of your chassis.

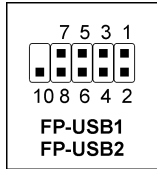
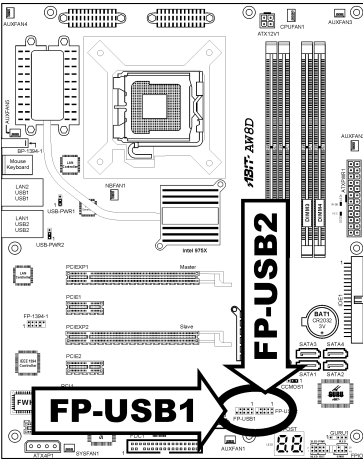

Pin	Pin Assignment	Pin	Pin Assignment
1	VCC	2	VCC
3	Data0 -	4	Data1 -
5	Data0 +	6	Data1 +
7	Ground	8	Ground
9	NC	10	NC

※ Make sure the connecting cable bears the same pin assignment.

## 2.6.2 Additional IEEE1394 Port Header

Besides the 1x IEEE1394 port located at rear I/O part, this motherboard also features 1x more IEEE1394 header on-board. Each header supports 1x additional IEEE1394 port by connecting bracket or cable to the rear I/O panel or the front-mounted IEEE1394 port of your chassis.

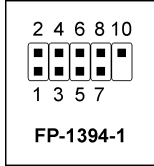
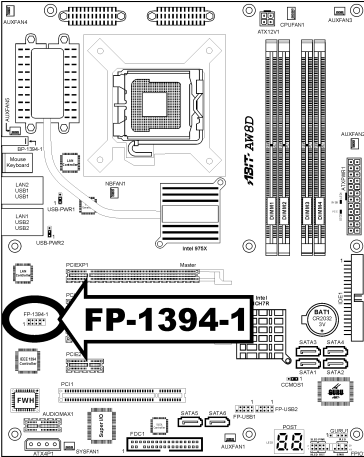

Pin	Pin Assignment	Pin	Pin Assignment
1	TPA0 +	2	TPA0 -
3	Ground	4	Ground
5	TPB0 +	6	TPB0 -
7	+12V	8	+12V
9	NC	10	Ground

※ Make sure the connecting cable bears the same pin assignment.

# 2.7 Onboard Status Display

## 2.7.1 POST Code Displayer

This is an LED device to display the "POST" Code, the acronym of **Power On Self Test**. The computer will execute the POST action whenever you power on the computer. The POST process is controlled by the BIOS. It is used to detect the status of the computer's main components and peripherals. Each POST Code corresponds to different checkpoints that are also defined by the BIOS in advance. For example, "memory presence test" is an important checkpoint and its POST Code is "C1". When the BIOS execute any POST item, it will write the corresponding POST Code into the address 80h. If the POST passes, the BIOS will process the next POST item and write the next POST Code into the address 80h. If the POST fails, we can check the POST Code in address 80h to find out where the problem lies.

This LED device also displays the "POST" Code of AC2005, an "uGuru" chipset developed exclusively by ABIT computer.

※ The decimal point lights up during the AC2005 POST action.

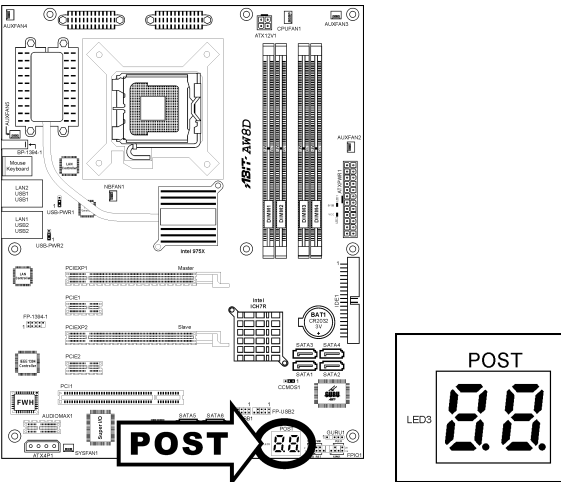

See Appendix for both AWARD and AC2005 POST Code definitions.



## 2.7.2 Power Source Indicators

These indicators work as a reminding device to display the power status of this motherboard with power source connected.

- **5VSB:** This LED lights up when the power supply is connected with power source.
- **VCC:** This LED lights up when the system power is on.

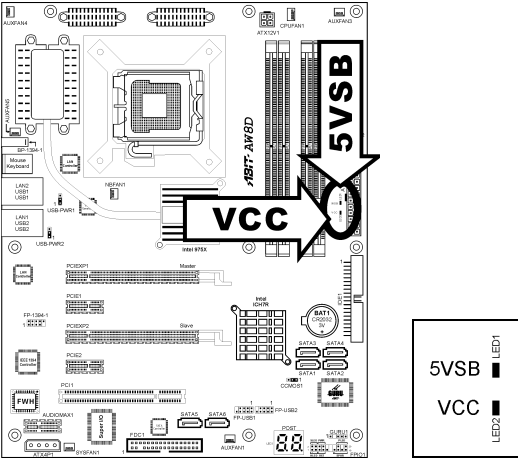

## 2.8 Connecting I/O Devices

The rear I/O part of this motherboard provides the following I/O ports:

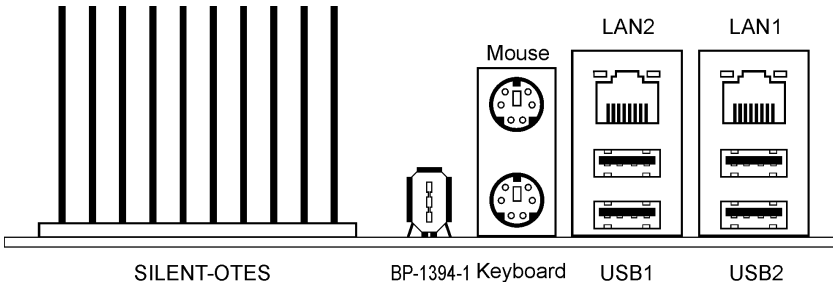

- **Silent OTES:** The Silent OTES (Silent Outside Thermal Exhaust System) is a device specifically designed to silently cool the motherboard's North Bridge chipset. (Keep the area for outgoing heat wave open.)
- **BP-1394-1:** Connects to devices of IEEE1394 protocol.
- **Mouse:** Connects to PS/2 mouse.
- **Keyboard:** Connects to PS/2 keyboard.
- **LAN1/LAN2:** Connects to Local Area Network.
- **USB1/USB2:** Connects to USB devices such as scanner, digital speakers, monitor, mouse, keyboard, hub, digital camera, joystick etc.

# 3. BIOS Setup

This motherboard provides a programmable EEPROM that you can update the BIOS utility. The BIOS (Basic Input/Output System) is a program that deals with the basic level of communication between processor and peripherals. Use the BIOS Setup program only when installing motherboard, reconfiguring system, or prompted to "Run Setup". This chapter explains the Setup Utility of BIOS utility.

After powering up the system, the BIOS message appears on the screen, the memory count begins, and then the following message appears on the screen:

PRESS DEL TO ENTER SETUP

If this message disappears before you respond, restart the system by pressing <Ctrl> + <Alt> + <Del> keys, or by pressing the Reset button on computer chassis. Only when it failed by these two methods can you restart the system by powering it off and then back on.

After pressing <Del> key, the main menu screen appears.

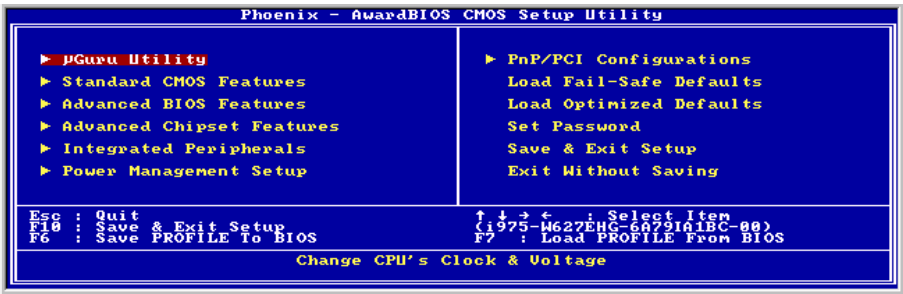

※ In order to increase system stability and performance, our engineering staffs are constantly improving the BIOS menu. The BIOS setup screens and descriptions illustrated in this manual are for your reference only, and may not completely match with what you see on your screen.

## 3.1 μGuru™ Utility

There are two setup menus in this μGuru utility. You may switch between these two by clicking the left or right arrow key on keyboard:

### 3.1.1 OC Guru

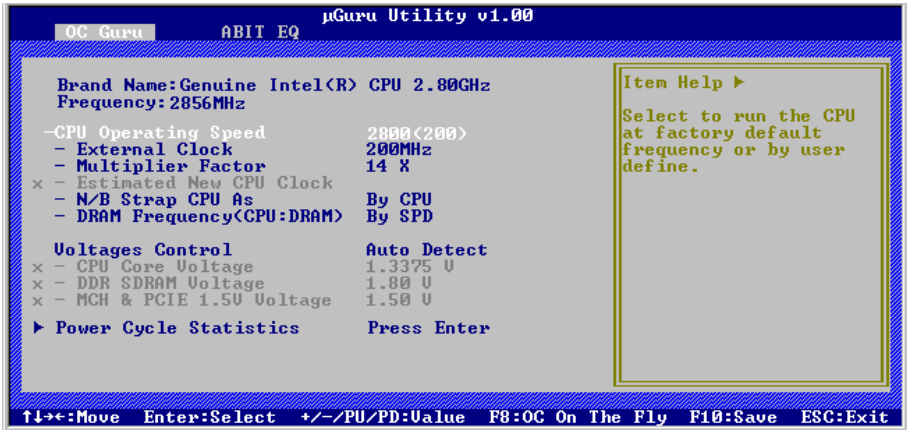

---

#### Brand Name

This item displays the CPU model name installed on this motherboard.

---

#### Frequency

This item displays the processor speed of the CPU installed on this motherboard.

---

#### CPU Operating Speed

This item displays the CPU operating speed according to the type and speed of your CPU. You can also select the [User Define] option to enter the manual option.

#### User Define:

- ※ The wrong settings of the multiplier and external clock in certain circumstances may cause CPU damage. Setting the working frequency higher than the PCI chipset or processor specs, may cause abnormal memory module functioning, system hangs, hard disk drive data lose, abnormal functioning of the VGA card, or abnormal functioning with other add-on cards. Using non-specification settings for your CPU is not the intention of this explanation. These should be used for engineering testing, not for normal applications.
- ※ There will be no guaranty for the settings beyond specification, any damage of any component on this motherboard or peripherals result therein is not our responsibility.

#### - **External Clock**

This item selects the external clock frequency. Due to the specification limit of the CPU you installed, the speed you set over its standard bus speed is supported, but not guaranteed.

#### - **Multiplier Factor**

This item displays the multiplier factor for the CPU you installed.

#### - **Estimated New CPU Clock**

This item displays an estimated CPU processor speed.

#### - **N/B Strap CPU As**

This item sets the external hardware reset strap assigned to MCH (Memory Controller Hub).

To set this option manually:

- Select [PSB533] for CPU of 133MHz FSB frequency.
- Select [PSB800] for CPU of 200MHz FSB frequency.
- Select [PSB1066] for CPU of 266MHz FSB frequency.

#### - **DRAM Frequency(CPU:DRAM)**

This item determines the DRAM frequency.

---

### **Voltages Control**

This option allows you to switch between the default and user-defined voltages. Leave this setting to default unless the current voltage setting cannot be detected or is not correct. The option "**User Define**" enables you to select the following voltages manually.

#### - **CPU Core Voltage**

This item selects the CPU core voltage.

#### - **DDR SDRAM Voltage**

This item selects the voltage for DRAM slot.

#### - **MCH & PCIE 1.5V Voltage**

This item selects the voltage for MCH & PCIE slot.

---

## Power Cycle Statistics

Click <Enter> key to enter its submenu:

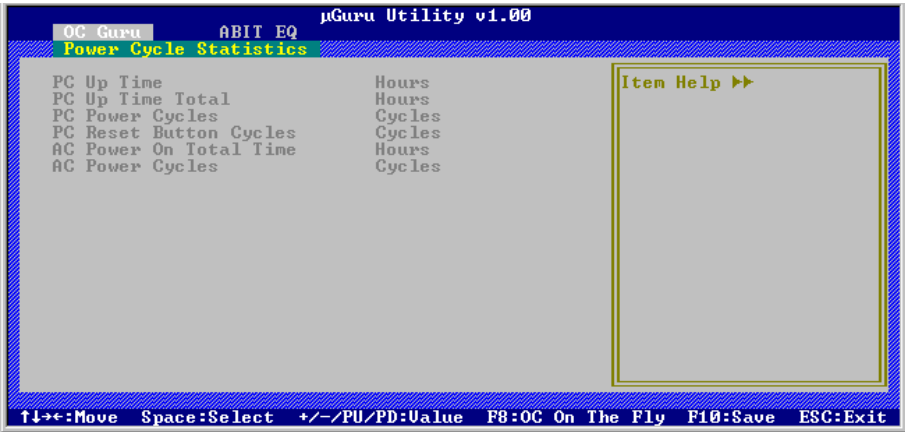

These items display the power cycle statistics for each element.

### 3.1.2 ABIT EQ

Click right-arrow <→> key to switch from OC Guru setup menu to ABIT EQ setup menu:

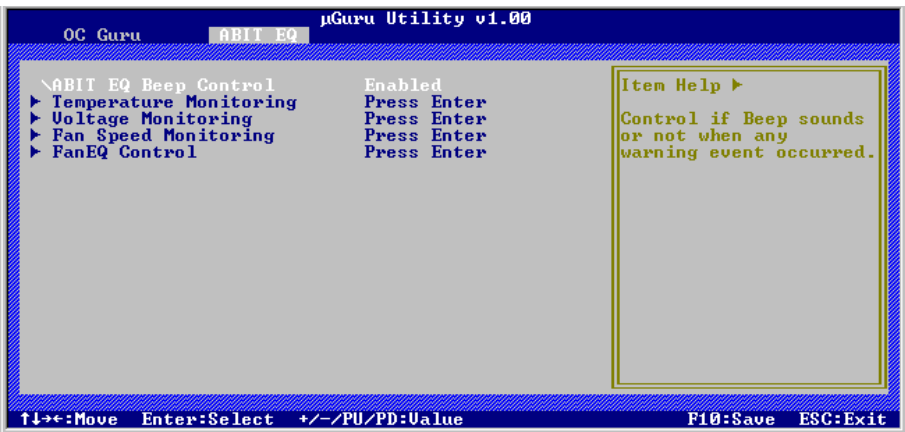

---

#### ABIT EQ Beep Control

This item allows you to enable or disable ABIT EQ Beep Control function.

## Temperature Monitoring

Click <Enter> key to enter its submenu:

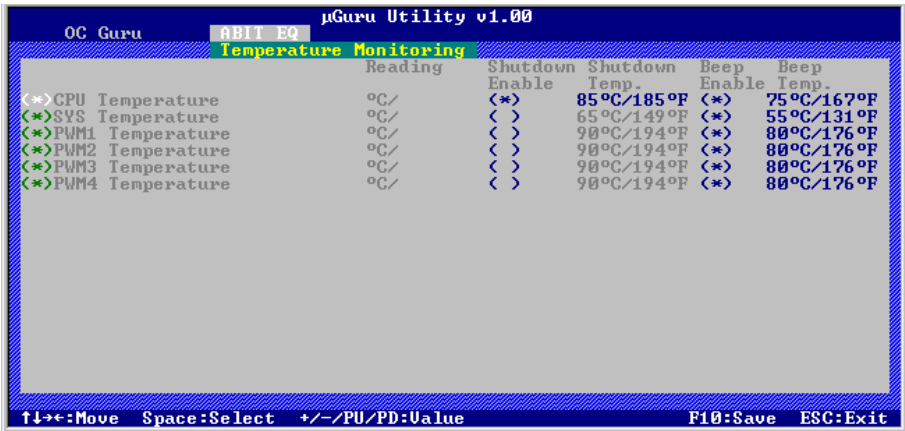

### CPU Temperature/SYS Temperature/PWM1~4 Temperature

These items display the temperature of CPU, System, and Power Module.

#### - Shutdown Enable

Use <Space> key to enable system shutdown function. If the CPU/System/PWM's temperature exceeds the shutdown temperature limit, the system would shutdown automatically.

#### - Shutdown Temp.

This items sets the temperature that would shutdown the system automatically in order to prevent system overheats.

#### - Beep Enable

Use <Space> key to enable warning beeps function. Once the system has detected that the CPU/System/PWM's temperature exceeded the beep temperature limit, warning beeps will sound.

#### - Beep Temp.

This item selects the warning temperature limit.

※ **The shutdown temperature must be set above the warning temperature.**

## ⏪ Voltage Monitoring

Click <Enter> key to enter its submenu:

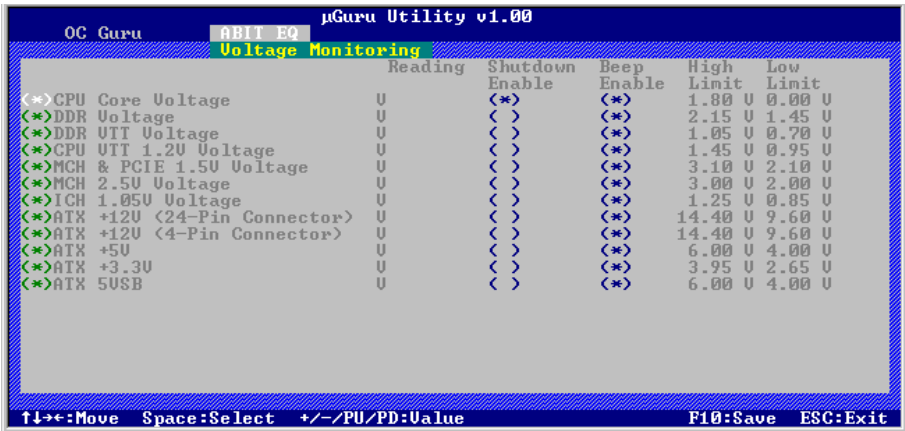

	Reading	Shutdown Enable	Beep Enable	High Limit	Low Limit
<*) CPU Core Voltage	U	<*)	<*)	1.80 U	0.00 U
<*) DDR Voltage	U	<*)	<*)	2.15 U	1.45 U
<*) DDR UTT Voltage	U	<*)	<*)	1.05 U	0.70 U
<*) CPU UTT 1.20 Voltage	U	<*)	<*)	1.45 U	0.95 U
<*) MCH & PCIE 1.50 Voltage	U	<*)	<*)	3.10 U	2.10 U
<*) MCH 2.50 Voltage	U	<*)	<*)	3.00 U	2.00 U
<*) ICH 1.05U Voltage	U	<*)	<*)	1.25 U	0.85 U
<*) ATX +12V <24-Pin Connector>	U	<*)	<*)	14.40 U	9.60 U
<*) ATX +12V <4-Pin Connector>	U	<*)	<*)	14.40 U	9.60 U
<*) ATX +5U	U	<*)	<*)	6.00 U	4.00 U
<*) ATX +3.3U	U	<*)	<*)	3.95 U	2.65 U
<*) ATX 5USB	U	<*)	<*)	6.00 U	4.00 U

↑↓←→:Move    Space:Select    +/-/PU/PD=Value    F10:Save    ESC:Exit

### All Voltages

These items display the voltage of each element.

#### - Shutdown Enable

Use <Space> key to enable system shutdown function. If the voltage of corresponding element is higher/lower than the high/low limit, the system would automatically shutdown.

#### - Beep Enable

Use <Space> key to enable warning beeps function. If the voltage of corresponding element is higher/lower than the high/low limit, warning beeps will sound.

#### - High/Low Limit

These items set the high and low voltage limit.

※ **The value of high limit must be set above the one of low limit.**



## ↩ Fan Speed Monitoring

Click <Enter> key to enter its submenu:

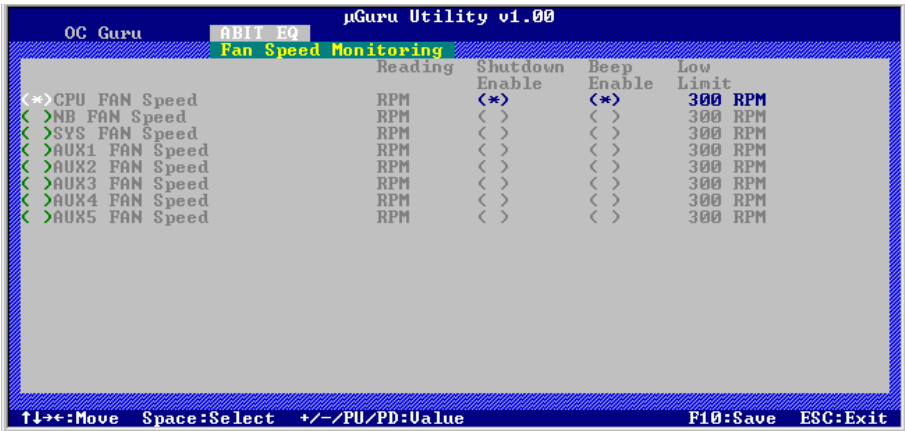

### CPU/NB/SYS/AUX FAN Speed

These items display the speed of the fans connected to CPU, NB, SYS, and AUX1~5 FAN headers.

#### - Shutdown Enable

Use <Space> key to enable system shutdown function. Once the system has detected that the fan speed is lower than the low limit value, system will shutdown automatically.

#### - Beep Enable

Use <Space> key to enable warning beeps function. If the fan speed is lower than the low limit value, warning beeps will sound.

#### - Low Limit

These items set the low limit of fan speed.

※ **Only the fans with 3-pin plugs provide the speed monitoring function.**

## ↩ FanEQ Control

Click <Enter> key to enter its submenu (1<sup>st</sup> FanEQ Group):

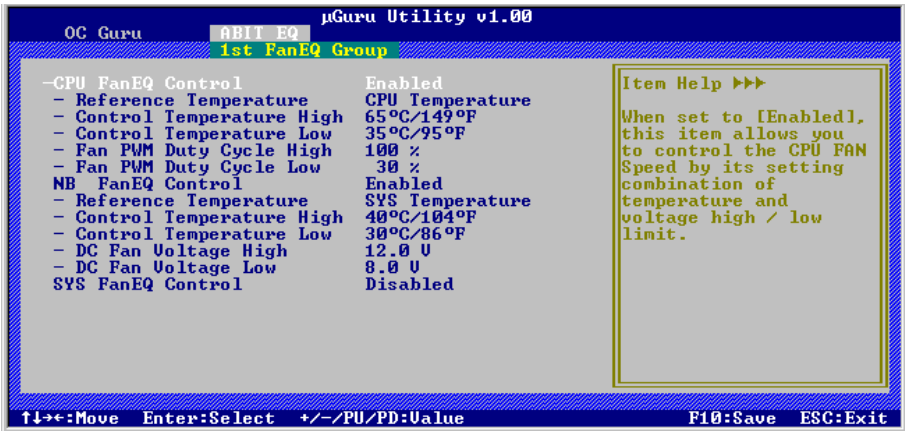

### CPU/NB/SYS FanEQ Control

When set to [Enabled], these items control the CPU, NB, and/or SYS fan speed by the following setting combinations.

#### - Reference Temperature

This item selects the reference point for taking temperature among the available options of CPU, SYS, and PWM Temperature, but there is only one "CPU Temperature" item to choose for the "CPU FanEQ Control".

#### - Control Temperature High/Low

These items set the high and low temperature limit that you want to do the fan speed control.

#### - Fan PWM Duty Cycle High/Low

These items set the high and low limit of PWM duty cycle that you want to provide the fan with.

#### - DC Fan Voltage High/Low

These items set the high and low voltage limit that you want to provide the fan with.

※ **The value of high limit must be set above the one of low limit.**

Click <Enter> key to enter its submenu (2<sup>nd</sup> FanEQ Group):

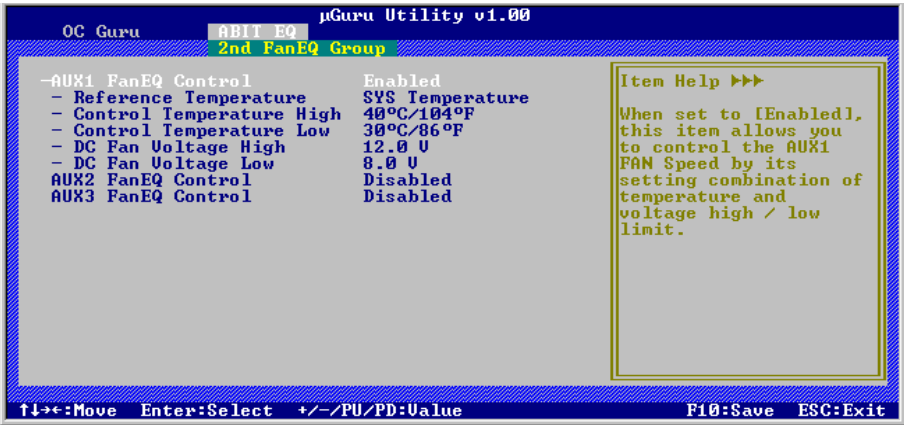

### AUX1~3 FanEQ Control

When set to [Enabled], these items control the AUX fan speed by the following setting combinations.

#### - Reference Temperature

This item selects the reference point for taking temperature among the available options of CPU, SYS, and PWM Temperature, but there is only one "CPU Temperature" item to choose for the "CPU FanEQ Control".

#### - Control Temperature High/Low

These items set the high and low temperature limit that you want to do the fan speed control.

#### - DC Fan Voltage High/Low

These items set the high and low voltage limit that you want to provide the fan with.

※ **The value of high limit must be set above the one of low limit.**

Click <Enter> key to enter its submenu (3<sup>rd</sup> FanEQ Group):

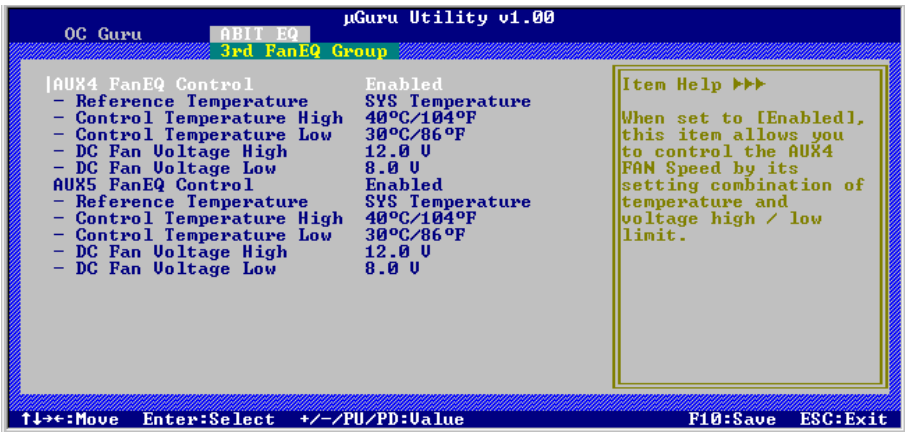

### AUX4~AUX5 FanEQ Control

When set to [Enabled], these items control the AUX4/AUX5 fan speed by the following setting combinations.

#### - Reference Temperature

This item selects the reference point for taking temperature among the available options of CPU, SYS, and PWM Temperature, but there is only one "CPU Temperature" item to choose for the "CPU FanEQ Control".

#### - Control Temperature High/Low

These items set the high and low temperature limit that you want to do the fan speed control.

#### - DC Fan Voltage High/Low

These items set the high and low voltage limit that you want to provide the fan with.

※ **The value of high limit must be set above the one of low limit.**

## 3.2 Standard CMOS Features



### Date (mm:dd:yy)

This item sets the date you specify (usually the current date) in the format of [Month], [Date], and [Year].

### Time (hh:mm:ss)

This item sets the time you specify (usually the current time) in the format of [Hour], [Minute], and [Second].

### ☞ IDE Channel 1 Master/Slave, IDE Channel 2 Master/Slave, IDE Channel 3 Master/Slave, IDE Channel 4 Master/Slave

Click <Enter> key to enter its submenu:

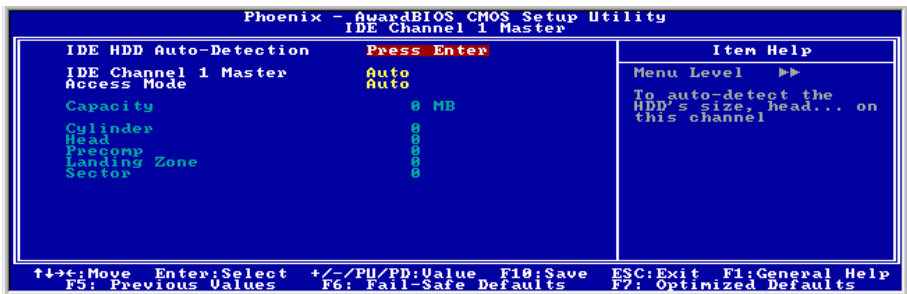

※ The items "IDE Channel 3 Master/Slave" and "IDE Channel 4 Master/Slave" appear only when the item "On-Chip SATA" in the "On-Chip IDE Device" menu is set to [Enhanced Mode], or set to [Auto] when SATA ports are connected with devices.

---

### **IDE HDD Auto-Detection**

This item allows you to detect the parameters of IDE drives by pressing <Enter> key. The parameters will be shown on the screen automatically.

---

### **IDE Channel 1 Master/Slave, IDE Channel 2 Master/Slave, Extended IDE Drive**

When set to [Auto], the BIOS will automatically check what kind of IDE drive you are using. If you want to define your own drive by yourself, set it to [Manual] and make sure you fully understand the meaning of the parameters. Please refer to the instruction manual provided by the device's manufacturer to get the setting right.

---

### **Access Mode**

This item selects the mode to access your IDE devices. Leave this item to its default [Auto] setting to detect the access mode of your HDD automatically.

---

### **Capacity**

This item displays the approximate capacity of the disk drive. Usually the size is slightly greater than the size of a formatted disk given by a disk-checking program.

---

### **Cylinder**

This item configures the numbers of cylinders.

---

### **Head**

This item configures the numbers of read/write heads.

---

### **Precomp**

This item displays the number of cylinders at which to change the write timing.

---

### **Landing Zone**

This item displays the number of cylinders specified as the landing zone for the read/write heads.

---

### **Sector**

This item configures the numbers of sectors per track.

---

## **Back to Standard CMOS Features Setup Menu**

---

### **Drive A & Drive B**

This item sets the type of floppy drives (usually only Drive A) installed.

---

### **Floppy 3 Mode Support**

This item allows you to use "3 Mode Floppy Drive" in Japanese computer systems by selecting drive A, B, or both. Leave this item to its default [Disabled] setting if you are not using this Japanese standard floppy drive.

---

**Halt On**

This item determines whether the system stops if an error is detected during system boot-up.

**[All Errors]:** The system-boot will stop whenever the BIOS detect a non-fatal error.

**[No Errors]:** The system-boot will not stop for any error detected.

**[All, But Keyboard]:** The system-boot will stop for all errors except a keyboard error.

**[All, But Diskette]:** The system-boot will stop for all errors except a diskette error.

**[All, But Disk/Key]:** The system-boot will stop for all errors except a diskette or keyboard error.

---

**Base Memory**

This item displays the amount of base memory installed in the system. The value of the base memory is typically 640K for system with 640K or more memory size installed on the motherboard.

---

**Extended Memory**

This item displays the amount of extended memory detected during system boot-up.

---

**Total Memory**

This item displays the total memory available in the system.

### 3.3 Advanced BIOS Features



---

#### CPU L3 Cache

This item is used to enable the L3 cache (default setting), and appears only for certain CPU (Intel Pentium 4 processor with HT Technology Extreme Edition) that possesses L3 cache.

---

#### Hyper-Threading Technology

This item is used to enable the functionality of the processor with Hyper-Threading Technology and will appear only when using such processor.

The Hyper-Threading Technology helps your PC work more efficiently by maximizing processor resources and enabling a single processor to run two separate threads of software simultaneously, bringing forth greater performance and system responsiveness when running multiple applications at once.

---

#### Quick Power On Self Test

When set to [Enabled], this item speeds up the Power On Self Test (POST) after powering on the system. The BIOS shorten or skip some check during the POST.



## CPU Feature

Click <Enter> key to enter its submenu:

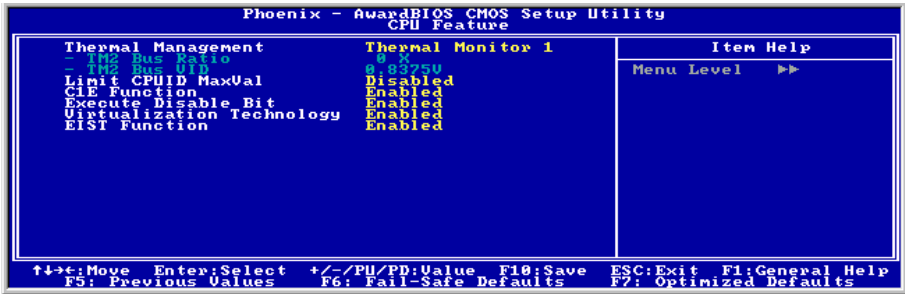

---

### Thermal Management

This item selects the type of thermal monitoring.

#### - TM2 Bus Ratio

This item represents the frequency (bus ratio) of the throttled performance state that will be initiated when the on-die sensor goes from not hot to hot.

#### - TM2 Bus VID

This item represents the voltage of the throttled performance state that will be initiated when the on-die sensor goes from not hot to hot.

---

### Limit CPUID MaxVal

When set to [Enabled], this item limits the CPUID maximum value to 3, which is usually required for older OS like Windows NT4.0.

Leave this item to its default [Disabled] settings for OS like Windows XP.

---

### C1E Function

This item appears only for certain processors with the C1E (Enhanced Halt State) Function. When set to [Enabled], the processor will further reduce the total power consumption.

---

### Execute Disable Bit

This item appears only for certain processors with the Execute Disable Bit (XD bit) feature. When set to [Enabled], this item allows the processor to prevent data pages from being used by malicious software to execute code and provide memory protection.

---

### Virtualization Technology

This option enables or disables the additional hardware capabilities provided by Virtualization Technology.

---

## EIST Function

This item appears only for certain processors with the EIST (Enhanced Intel SpeedStep Technology) Function. When set to [Enabled], EIST will dynamically switch between multiple frequency and voltage points to optimize the power and performance balance of the processor and system based on demand.

## Back to Advanced BIOS Features Setup Menu

---

### Hard Disk Boot Priority

This item selects the hard disks booting priority. By pressing <Enter> key, you can enter its submenu where the hard disks detected can be selected for the booting sequence to boot up system.

This item functions only when there is the option of [Hard Disk] in any one of the First/Second/Third Boot Device items.

---

### First Boot Device / Second Boot Device / Third Boot Device / Boot Other Device

Select the drive to boot first, second and third in the [First Boot Device], [Second Boot Device], and [Third Boot Device] items respectively. The BIOS will boot the operating system according to the sequence of the drive selected. Set [Boot Other Device] to [Enabled] if you wish to boot from another device other than these three items.

---

### Swap Floppy Drive

When set to [Enabled], and the system is booting from the floppy drive, the system will boot from drive B instead of the regular drive A. There must be two floppy drives connected in the system to use this function.

---

### Boot Up Floppy Seek

When set to [Enabled], the BIOS will check whether the floppy disk drive is installed or not.

---

### Boot Up NumLock Status

This item determines the default state of the numeric keypad at system booting up.

**[On]:** The numeric keypad functions as number keys.

**[Off]:** The numeric keypad functions as arrow keys.

---

### Security Option

This item determines when the system will prompt for password - every time the system boots or only when enters the BIOS setup.

**[Setup]:** The password is required only when accessing the BIOS Setup.

**[System]:** The password is required each time the computer boots up.

※ **Don't forget your password. If you forget the password, you will have to open the computer case and clear all information in the CMOS before you can start up the system. But by doing this, you will have to reset all previously set options.**

---

**MPS Version Ctrl For OS**

This item specifies which version of MPS (Multi-Processor Specification) this motherboard will use. Leave this item to its default setting.

---

**Report No FDD For OS**

When set to [Yes], this item allows you to run some older operating system without floppy disk drive. Leave this item to its default setting.

---

**Delay IDE Initial (Secs)**

This item allows the BIOS to support some old or special IDE devices by prolonging this delay time. A larger value will give more delay time to the device for which to initialize and to prepare for activation.

---

**Full Screen LOGO Show**

This item determines to show the full screen logo when booting.

---

**Disable Unused PCI Clock**

This option disables the clock of PCI slot that is not in use.

**[Yes]:** The system automatically detect the unused DIMM and PCI slots, and stop sending clock signal to these unused PCI slots.

**[No]:** The system always send clock signal to all PCI slots.

※ **Set this option to [No] setting if there are adapters that cannot be automatically detected by the system and will cause malfunction.**

## 3.4 Advanced Chipset Features



### DRAM Timing Selectable

This item sets the optimal timings for the following four items, depending on the memory module you are using. The default setting "By SPD" configures these four items by reading the contents in the SPD (Serial Presence Detect) device. The EEPROM on the memory module stores critical parameter information about the module, such as memory type, size, speed, voltage interface, and module banks.

#### - CAS Latency Time (tCL)

This item controls the latency between the DRAM read command and the time that the data becomes actually available.

#### - RAS# to CAS# Delay (tRCD)

This item controls the latency between the DRAM active command and the read/write command.

#### - RAS# Precharge (tRP)

This item controls the idle clocks after issuing a precharge command to the DRAM.

#### - Precharge Delay (tRAS)

This item controls the number of DRAM clocks used for the DRAM parameters.

### Memory Hole At 15M-16M

When set to [Enabled], the memory address space at 15M-16M will be reserved for ISA expansion cards that specifically requires this setting. This makes the memory from 15MB and up unavailable to the system. Leave this item to its default setting.

## ↳ PCI Express Root Port Func

Click <Enter> key to enter its submenu:

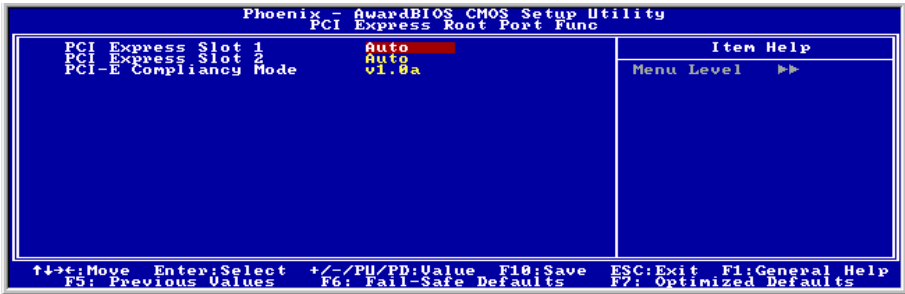

---

### PCI Express Slot 1 / PCI Express Slot 2

This option enables or disables the PCI Express port function.

---

### PCI-E Compliancy Mode

This item selects the mode for PCI Express add-on card.

## ↳ Back to Advanced Chipset Features Setup Menu

---

### PEG Force X1

When set to [Enabled], this item forces the PEG port down to x1 mode.

---

### Init Display First

This item selects whether to initiate from "PCI Express Slot" or "PCI Slot" first when system boots up.

## 3.5 Integrated Peripherals

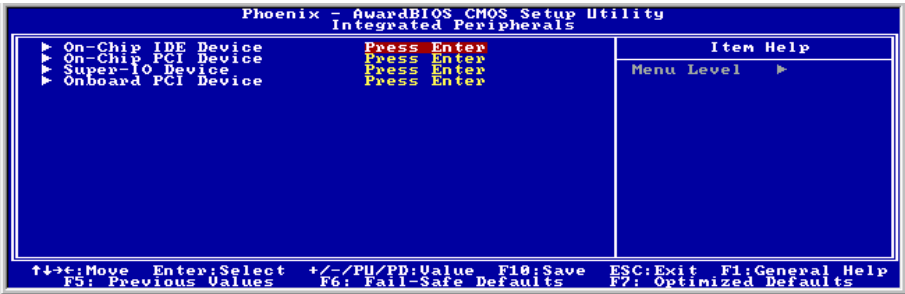

### ↩ On-Chip IDE Device

Click <Enter> key to enter its submenu:



---

#### IDE Bus Master

This option enables or disables the IDE bus mastering capability under the DOS environment.

---

#### On-Chip IDE-1 Controller

This item selects whether to enable or disable the IDE-1 controller.

---

#### On-Chip SATA Mode

This item determines the mode for on-chip Serial ATA.

**[IDE]:** The on-chip Serial ATA served as IDE mode.

**[RAID]:** The on-chip Serial ATA served as RAID mode.

**[AHCI]:** The on-chip Serial ATA served as AHCI (Advanced Host Controller Interface) mode for advanced performance and usability.

※ **The [RAID] option is only available when the item "On-Chip SATA" is set to [Enhanced Mode].**

## - SATA RAID ROM

This item allows you to use the boot ROM of on-chip Serial ATA RAID to boot up system.

---

### On-Chip SATA

This item determines the function for on-chip Serial ATA.

**[Disabled]:** Disable the Serial ATA controller.

**[Auto]:** Allows the Serial ATA controller to be arranged by BIOS automatically.

**[Combined Mode]:** Parallel ATA and Serial ATA are combined together. Supports up to 4 IDE drives.

**[Enhanced Mode]:** Enable both Parallel ATA and Serial ATA. Supports up to 6 IDE drives.

**[SATA Only]:** The SATA is operating in legacy mode.

※ **This option is configurable only when the item [On-Chip SATA Mode] is set to [IDE].**

Mode	IDE Channel 1 Master	IDE Channel 1 Slave	IDE Channel 2 Master	IDE Channel 2 Slave	IDE Channel 3 Master	IDE Channel 3 Slave	IDE Channel 4 Master	IDE Channel 4 Slave
Enhanced	IDE1 Master	IDE1 Slave	None	None	SATA1	SATA3	SATA2	SATA4
Combined	IDE1 Master	IDE1 Slave	SATA2	SATA4	None	None	None	None
SATA Only	SATA1	SATA3	SATA2	SATA4	None	None	None	None

※ **The option [Enhanced Mode] does not support the Windows 98/ME operation system.**

---

### SATA PORT Speed Settings

This item selects the mode for SATA PORT.

#### - PATA IDE Mode

This item determines the function mode for "IDE1"connector.

**[IDE-1]:** "IDE1" connector served as [Primary Master] and [Primary Slave] channel. "SATA2" and "SATA4"connector served as [Secondary Master] and [Secondary Slave] channel. The remaining "SATA1" and "SATA3" connectors are disabled.

**[IDE-2]:** "IDE1" connector served as [Secondary Master] and [Secondary Slave] channel. "SATA1" and "SATA3" connector served as [Primary Master] and [Primary Slave] channel. The remaining "SATA2" and "SATA4" connectors are disabled.

Refer to the following table for the relationships between IDE and SATA ports.

PATA IDE Mode	IDE Channel 1 Master	IDE Channel 1 Slave	IDE Channel 2 Master	IDE Channel 2 Slave	IDE Channel 3 Master	IDE Channel 3 Slave	IDE Channel 4 Master	IDE Channel 4 Slave
Primary	IDE1 Master	IDE1 Slave	SATA2	SATA4	None	None	None	None
Secondary	SATA1	SATA3	IDE1 Master	IDE1 Slave	None	None	None	None

※ **This option is configurable only when the item [On-Chip SATA] is set to [Combined Mode].**

- **SATA Mode**

This item displays the variety modes for SATA Mode.

↳ **On-Chip PCI Device**

Click <Enter> key to enter its submenu:



---

**On-Chip USB Controller**

This option enables or disables the USB controller.

- **USB 2.0 Controller**

This option enables or disables the USB 2.0 controller.

- **USB Keyboard Support via**

Select [**BIOS**] (the default setting) for the legacy operating system (such as DOS) that does not support USB keyboard.

- **USB Mouse Support via**

Select [**BIOS**] (the default setting) for the legacy operating system (such as DOS) that does not support USB mouse.

---

**On-Chip Audio Controller**

This option enables or disables the audio controller.

↳ **Super-IO Device**

Click <Enter> key to enter its submenu:

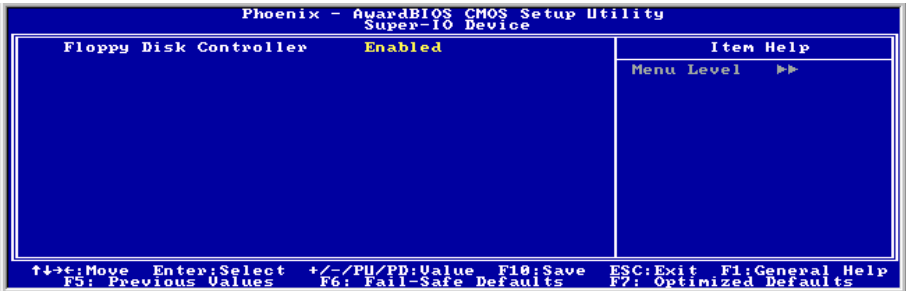



---

## Floppy Disk Controller

This option enables or disables the floppy disk controller.

## ↳ Onboard PCI Device

Click <Enter> key to enter its submenu:

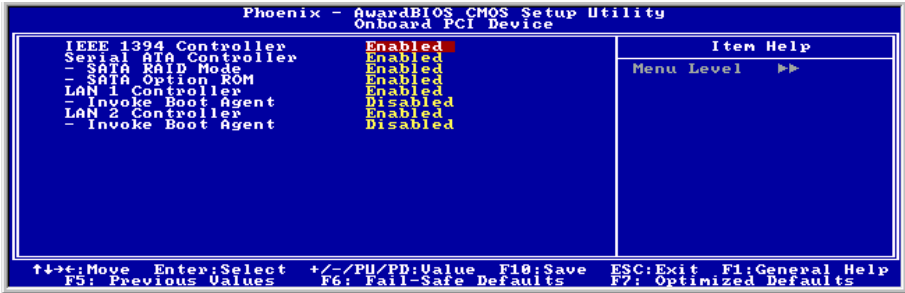

---

## IEEE 1394 Controller

This option enables or disables the IEEE 1394 controller.

---

## Serial ATA Controller

This option enables or disables the Serial ATA controller.

### - SATA RAID Mode

This item determines to enable or disable the RAID mode for onboard SATA controller.

### - SATA Option ROM

This item allows you to use the boot ROM of onboard Serial ATA RAID to boot up system.

---

## LAN 1 Controller / LAN 2 Controller

This option enables or disables the LAN controller.

### - Invoke Boot Agent

This item allows you to use the boot ROM (instead of a disk drive) to boot up the system and access the local area network directly.

## 3.6 Power Management Setup

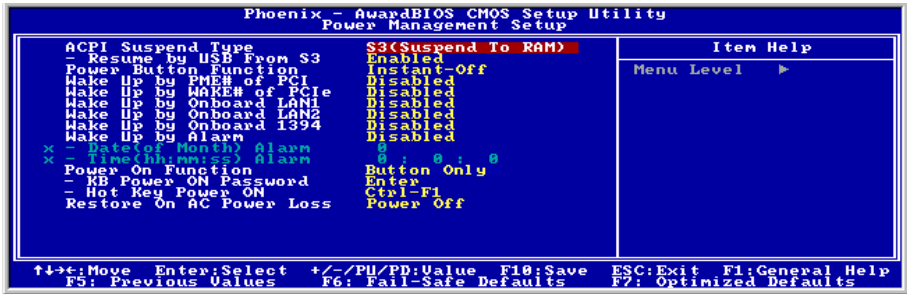

### ACPI Suspend Type

This item selects the type of Suspend mode.

**[S1(PowerOn Suspend)]:** Enables the Power On Suspend function.

**[S3(Suspend To RAM)]:** Enables the Suspend to RAM function.

#### - Resume by USB From S3

When set to [Enabled], this item allows you to use a USB device to wake up a system that is in the S3 (STR - Suspend To RAM) state. This item can be configured only if the item "ACPI Suspend Type" is set to [S3(STR)].

### Power Button Function

This item selects the method of powering off your system:

**[Delay 4 Sec.]:** Pushing the power button for more than 4 seconds will power off the system. This will prevent the system from powering off in case you accidentally hit or pushed the power button.

**[Instant-Off]:** Pressing and then releasing the power button at once will immediately power off the system.

### Wake Up by PME# of PCI

When set to [Enabled], access through the add-on PCI card can remotely wake up the system that was in Soft-Off condition. The PCI card must support the wake up function.

### Wake Up by Wake# of PCIe

When set to [Enabled], access through the add-on PCI Express card can remotely wake up the system that was in Soft-Off condition. The PCI Express card must support the wake up function.

### Wake Up by Onboard LAN1

When set to [Enabled], access through the onboard LAN1 port can remotely wake up the system that was in Soft-Off condition.

---

### Wake Up by Onboard LAN2

When set to [Enabled], access through the onboard LAN2 port can remotely wake up the system that was in Soft-Off condition.

---

### Wake Up by Onboard 1394

When set to [Enabled], access through the onboard IEEE 1394 device can remotely wake up the system that was in Soft-Off condition.

---

### Wake Up by Alarm

When set to [Enabled], you can set the date and time you would like the Soft-Off PC to power-on in the "Date (of Month) Alarm" and "Time (hh:mm:ss) Alarm" items. However, if the system is being accessed by incoming calls or the network (Resume On Ring/LAN) prior to the date and time set in these items, the system will give priority to the incoming calls or network instead.

#### - Date (of Month) Alarm

**[0]:** This option power-on the system everyday according to the time set in the "Time (hh:mm:ss) Alarm" item.

**[1-31]:** This option selects a date you would like the system to power-on. The system will power-on on the date set, and the time set in the "Time (hh:mm:ss) Alarm" item.

#### - Time (hh:mm:ss) Alarm

This item sets the time you would like the system to power-on.

---

### Power On Function

This item selects the way you want your system to power on.

**[Password]:** Use a password to power on the system, select this option then press <Enter>. Enter your password. You can enter up to 5 characters. Type in exactly the same password to confirm, and then press <Enter>.

**[Hot KEY]:** Use any of the function keys between <F1> to <F12> to power on the system.

**[Mouse Left]:** Double click the mouse left button to power on the system.

**[Mouse Right]:** Double click the mouse right button to power on the system.

**[Any KEY]:** Use any keyboard keys to power on the system.

**[Button Only]:** Use only the power button to power on the system.

**[Keyboard 98]:** Use the power-on button on the "Keyboard 98" compatible keyboard to power on the system.

※ **To enable this "Power On" function, the wake-up header of [USB-PWR1] and [USB-PWR2] must be set to [Enabled] position. Please refer to the configuration of "Wake-up Header" [USB-PWR1] and [USB-PWR2] in section 2.3.2, chapter 2.**

※ **The mouse wake up function can only be used with the PS/2 mouse, not with the COM port or USB type. Some PS/2 mice cannot wake up the system because of compatible problems. If the specs of your keyboard are too old, it may fail to power on.**

- **KB Power ON Password**

This item sets the password required in order to power on your computer.

※ **Do not forget your password, or you will have to clear the CMOS and reset all parameters in order to utilize this function again.**

- **Hot Key Power ON**

This item powers on the system by pressing <Ctrl> key plus one of each function key (<F1> ~ <F12>) simultaneously.

---

**Restore On AC Power Loss**

This item selects the system action after an AC power failure.

**[Power Off]:** When power returns after an AC power failure, the system's power remains off. You must press the Power button to power-on the system.

**[Power On]:** When power returns after an AC power failure, the system's power will be powered on automatically.

**[Last State]:** When power returns after an AC power failure, the system will return to the state where you left off before power failure occurs. If the system's power is off when AC power failure occurs, it will remain off when power returns. If the system's power is on when AC power failure occurs, the system will power-on when power returns.

## 3.7 PnP/PCI Configurations



### Resources Controlled By

This item configures all of the boot and Plug-and-Play compatible devices.

**[Auto]:** The system will automatically detect the settings.

**[Manual]:** Choose the specific IRQ resources in the "IRQ Resources" menu.

#### - IRQ Resources

Click <Enter> key to enter its submenu:

This item sets each system interrupt to either [PCI Device] or [Reserved].



### PCI/VGA Palette Snoop

This item determines whether the MPEG ISA/VESA VGA cards can work with PCI/VGA or not.

**[Enabled]:** MPEG ISA/VESA VGA cards work with PCI/VGA.

**[Disabled]:** MPEG ISA/VESA VGA cards do not work with PCI/VGA.

### PCI Latency Timer (CLK)

This item controls how long each PCI device can hold the bus before another takes over. When set to higher values, every PCI device can conduct transactions for a longer time and thus

improve the effective PCI bandwidth. For better PCI performance, you should set the item to higher values.

---

### **Maximum Payload Size**

This item sets the maximum TLP payload size for the PCI Express devices.

## **3.8 Load Fail-Safe Defaults**

This option loads the BIOS default values for the most stable, minimal-performance system operations.

## **3.9 Load Optimized Defaults**

This option loads the BIOS default values that are factory settings for optimal-performance system operations.

## **3.10 Set Password**

This option protects the BIOS configuration or restricts access to the computer itself.

## **3.11 Save & Exit Setup**

This option saves your selections and exits the BIOS setup menu.

## **3.12 Exit Without Saving**

This option exits the BIOS setup menu without saving any changes.

# 4. Driver & Utility CD Support

The "Driver & Utility CD" that came packed with this motherboard contains drivers, utilities and software applications required for its basic and advanced features.

Place the "Driver & Utility CD" into the CD-ROM drive in your system. The following installation auto-run screen appears. If not, browse the root directory of the CD-ROM via the File Manager, and double click the "AUTORUN" file.



- **[Drivers]**: Click to enter the driver installation menu.
- **[Manual]**: Click to enter the user's manual menu.
- **[Utility]**: Click to enter the utilities installation menu.
- **[ABIT Utility]**: Click to enter the installation menu of utilities exclusively developed by ABIT.
- **[Browse CD]**: Click to browse the contents of this "Driver & Utility CD".
- **[Close]**: Click to exit this installation menu.

## 4.1 Intel Chipset Software Installation Utility

This utility installs Windows [INF] files to the target system. These files outline to the operating system how to configure the Intel chipset components in order to ensure all the features function properly.

To install this utility:

1. Click on the [Drivers] tab in the installation menu screen.
2. Click the [Intel Chipset Software Installation Utility] item under the [Drivers] tab. The following screen appears:

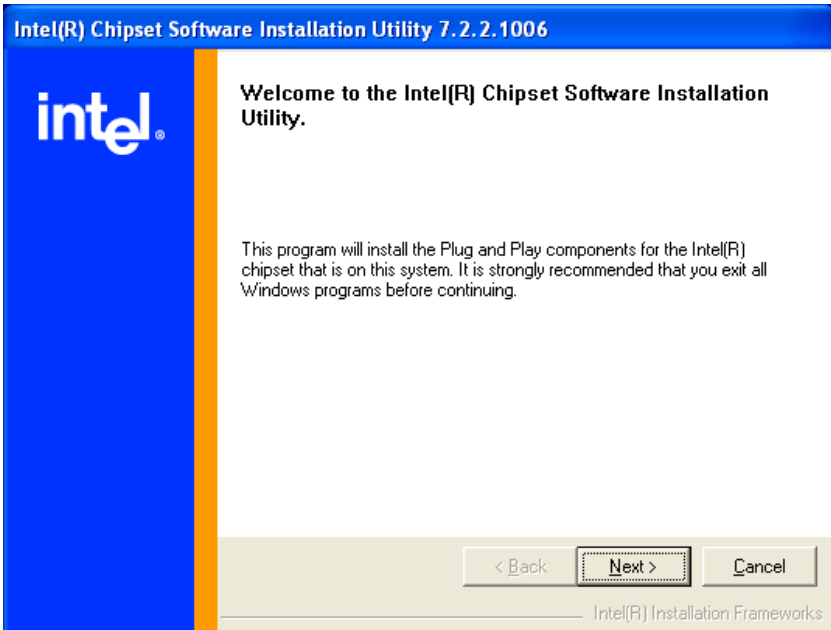

3. Follow the prompts on the screen to complete installation.
4. Restart the system for the driver to take effect.



## 4.2 Intel Matrix Storage Technology Driver

This driver provides functionality for the on-chip SATA Controller.

To install this driver:

1. Click on the [Drivers] tab in the installation menu screen.
2. Click the [Intel Matrix Storage Technology Driver] item under the [Drivers] tab. The following screen appears:

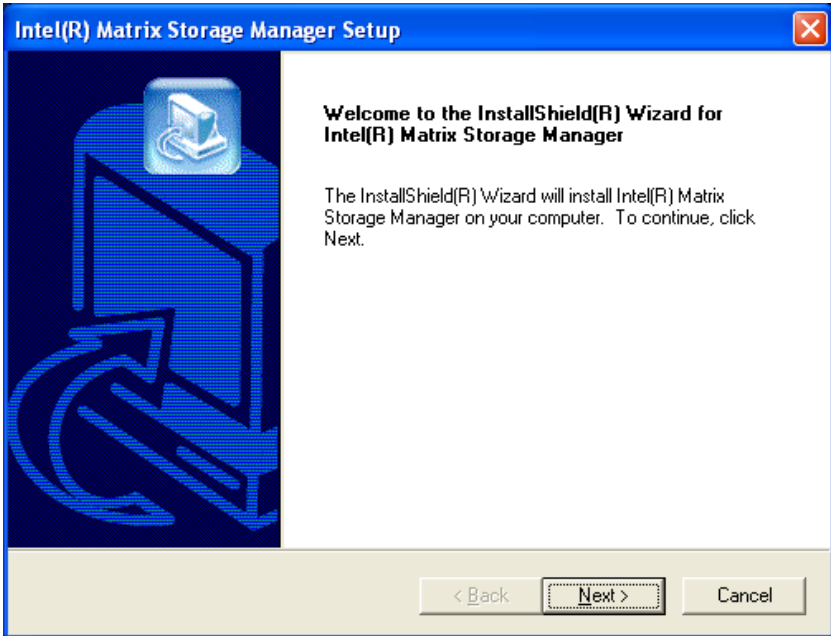

3. Follow the prompts on the screen to complete installation.
4. Restart the system for the driver to take effect.

## 4.3 Realtek Audio Driver

This driver provides functionality for the onboard High Definition Audio Codec.

※ **The installation of this driver is necessary only after having installed the "AudioMAX" daughter-card.**

To install this driver:

1. Click on the [Drivers] tab in the installation menu screen.
2. Click the [Audio Driver] item under the [Drivers] tab. The following screen appears:

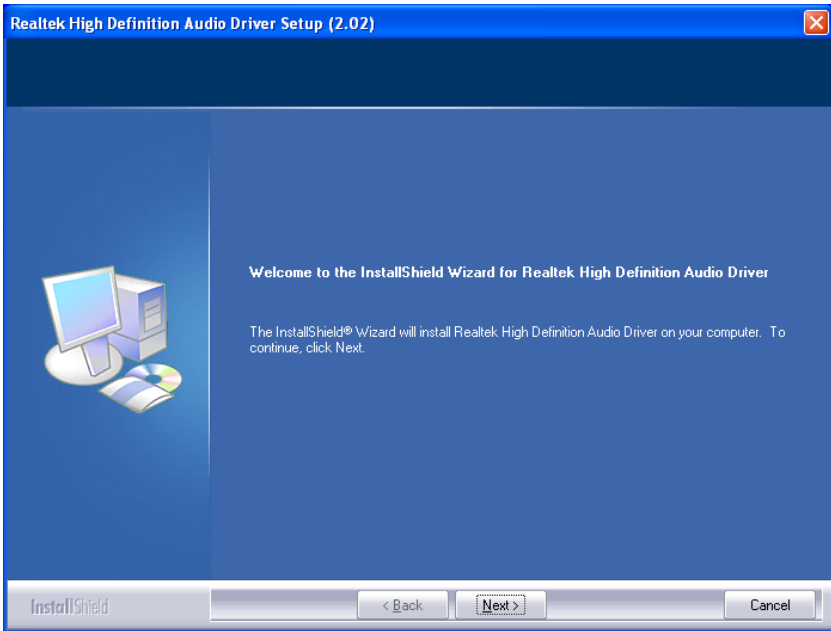

3. Follow the prompts on the screen to complete installation.
4. Restart the system for the driver to take effect.

## 4.4 Realtek LAN Driver

This driver provides functionality for the onboard PCIE Gigabit and Fast Ethernet NIC Controller.

To install this driver:

1. Click on the [Drivers] tab in the installation menu screen.
2. Click the [LAN Driver] item under the [Drivers] tab. The following screen appears:

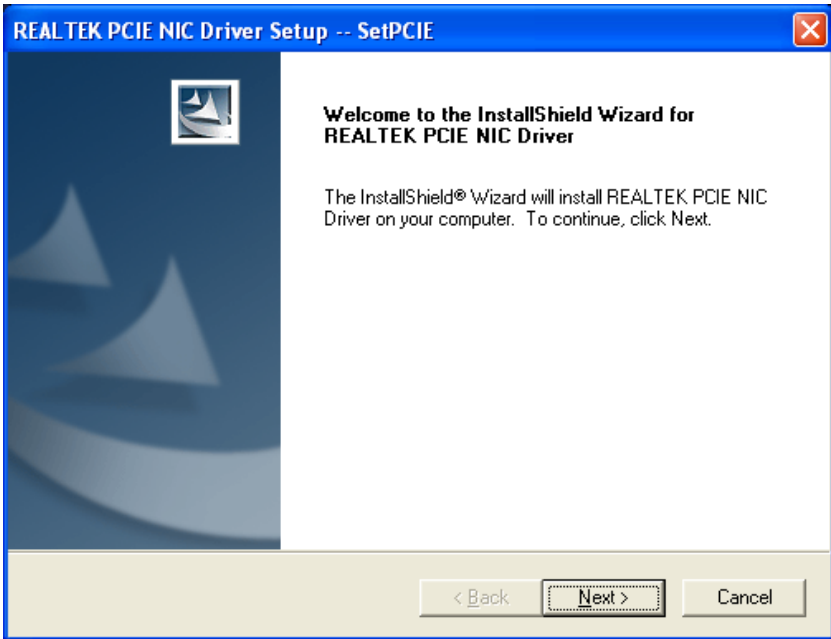

3. Follow the prompts on the screen to complete installation.
4. Restart the system for the driver to take effect.

## 4.5 Silicon Image 3132 SATA Driver

This driver provides functionality for the onboard SATA Controller.

To install this driver:

1. Click on the [Drivers] tab in the installation menu screen.
2. Click the [Sil3132 SATA Driver] item under the [Drivers] tab. The following screen appears:

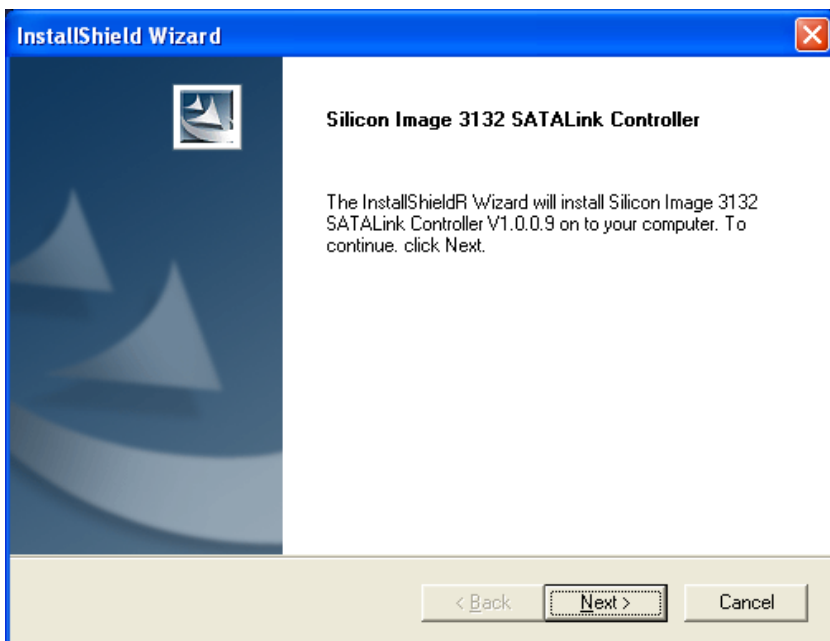

3. Follow the prompts on the screen to complete installation.
4. Restart the system for the driver to take effect.

## 4.6 Silicon Image 3132 SATA RAID Driver

This driver provides functionality for the onboard SATA RAID Controller.

※ **The installation of this driver is necessary only after having enabled the RAID function in the BIOS setup menu.**

To install this driver:

1. Click on the [Drivers] tab in the installation menu screen.
2. Click the [Sil3132 SATA RAID Driver] item under the [Drivers] tab. The following screen appears:

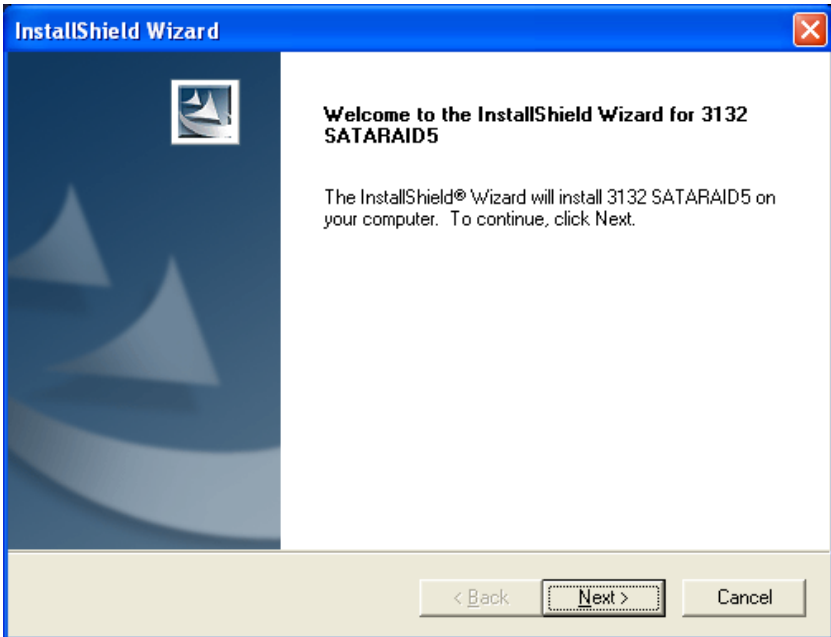

3. Follow the prompts on the screen to complete installation.
4. Restart the system for the driver to take effect.

## 4.7 USB 2.0 Driver

- ※ **There is no need to install this driver for Windows 2000 with Service Pack 4, Windows XP with Service Pack 1, or their later version.**

## 4.8 ABIT $\mu$ Guru Utility

The  $\mu$ Guru Utility combined with the optional Guru Clock allows you to access and select system performance of your system while playing games, listening music, browsing Internet or office applications in full screen with no need to stop or close the running application.

To install this utility:

1. Click on the [ABIT Utility] tab in the installation menu screen.
2. Click the [ABIT Guru] item under the [ABIT Utility] tab. The following screen appears:

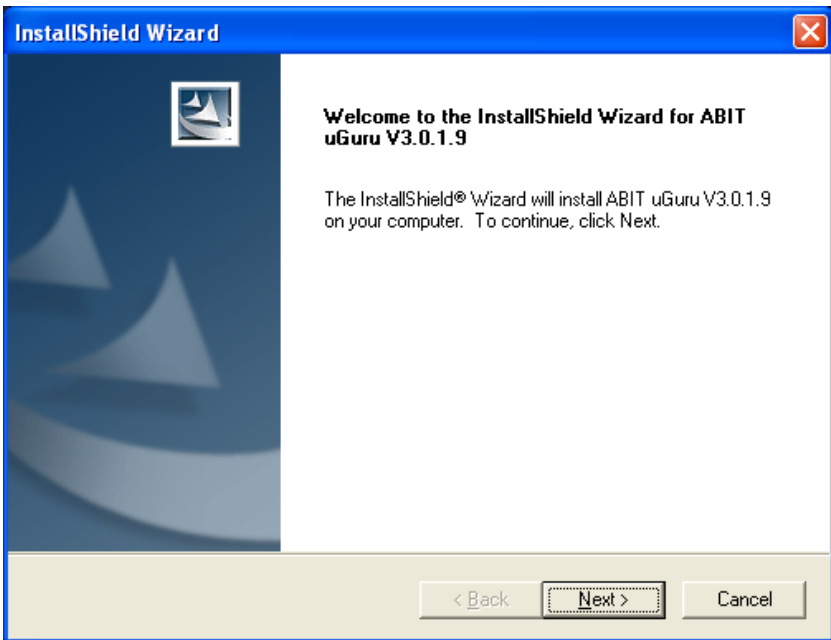

3. Follow the prompts on the screen to complete installation.
4. Restart the system for the driver to take effect.

# 5. Appendix

## 5.1 POST Code Definitions

### 5.1.1 AWARD POST Code Definitions

POST (hex)	Description
<b>CF</b>	Test CMOS R/W functionality
<b>C0</b>	Early chipset initialization: -Disable shadow RAM -Disable L2 cache (socket 7 or below) -Program basic chipset registers
<b>C1</b>	Detect memory -Auto-detection of DRAM size, type and ECC -Auto-detection of L2 cache (socket 7 or below)
<b>C3</b>	Expand compressed BIOS code to DRAM
<b>C5</b>	Call chipset hook to copy BIOS back to E000 & F000 shadow RAM
<b>01</b>	Expand the Xgroup codes locating in physical address 1000:0
<b>03</b>	Initial Superio_Early_Init switch
<b>05</b>	1. Blank out screen 2. Clear CMOS error flag
<b>07</b>	1. Clear 8042 interface 2. Initialize 8042 self-test
<b>08</b>	1. Test special keyboard controller for Winbond 977 series Super I/O chips 2. Enable keyboard interface
<b>0A</b>	1. Disable PS/2 mouse interface (optional) 2. Auto detect ports for keyboard & mouse followed by a port & interface swap (optional) 3. Reset keyboard for Winbond 977 series Super I/O chips
<b>0E</b>	Test F000h segment shadow to see whether it is R/W-able or not. If test fails, keep beeping the speaker
<b>10</b>	Auto detect flash type to load appropriate flash R/W codes into the run time area in F000 for ESCD & DMI support
<b>12</b>	Use walking 1's algorithm to check out interface in CMOS circuitry. Also set real-time clock power status, and then check for override
<b>14</b>	Program chipset default values into chipset. Chipset default values are MODBINable by OEM customers
<b>16</b>	Initial onboard clock generator if Early_Init_Onboard_Generator is defined. See also POST 26.
<b>18</b>	Detect CPU information including brand, SMI type (Cyrix or Intel) and CPU level (586 or 686)
<b>1B</b>	Initial interrupts vector table. If no special specified, all H/W interrupts are directed to SPURIOUS_INT_HDLR & S/W interrupts to SPURIOUS_soft_HDLR.
<b>1D</b>	Initial EARLY_PM_INIT switch
<b>1F</b>	Load keyboard matrix (notebook platform)
<b>21</b>	HPM initialization (notebook platform)
<b>23</b>	1. Check validity of RTC value: e.g. a value of 5Ah is an invalid value for RTC minute. 2. Load CMOS settings into BIOS stack. If CMOS checksum fails, use default value instead.
<b>24</b>	Prepare BIOS resource map for PCI & PnP use. If ESCD is valid, take into consideration of the ESCD's legacy information.

<b>25</b>	Early PCI Initialization: -Enumerate PCI bus number. -Assign memory & I/O resource -Search for a valid VGA device & VGA BIOS, and put it into C000:0
<b>26</b>	1. If Early_Init_Onboard_Generator is not defined Onboard clock generator initialization. Disable respective clock resource to empty PCI & DIMM slots. 2. Init onboard PWM 3. Init onboard H/W monitor devices
<b>27</b>	Initialize INT 09 buffer
<b>29</b>	1. Program CPU internal MTRR (P6 & PII) for 0-640K memory address. 2. Initialize the APIC for Pentium class CPU. 3. Program early chipset according to CMOS setup. Example: onboard IDE controller. 4. Measure CPU speed.
<b>2B</b>	Invoke Video BIOS
<b>2D</b>	1. Initialize double-byte language font (Optional) 2. Put information on screen display, including Award title, CPU type, CPU speed, full screen logo.
<b>33</b>	Reset keyboard if Early_Reset_KB is defined e.g. Winbond 977 series Super I/O chips. See also POST 63.
<b>35</b>	Test DMA Channel 0
<b>37</b>	Test DMA Channel 1.
<b>39</b>	Test DMA page registers.
<b>3C</b>	Test 8254
<b>3E</b>	Test 8259 interrupt mask bits for channel 1
<b>40</b>	Test 8259 interrupt mask bits for channel 2
<b>43</b>	Test 8259 functionality
<b>47</b>	Initialize EISA slot
<b>49</b>	1. Calculate total memory by testing the last double word of each 64K page 2. Program writes allocation for AMD K5 CPU
<b>4E</b>	1. Program MTRR of M1 CPU 2. Initialize L2 cache for P6 class CPU & program CPU with proper cacheable range 3. Initialize the APIC for P6 class CPU 4. On MP platform, adjust the cacheable range to smaller one in case the cacheable ranges between each CPU are not identical
<b>50</b>	Initialize USB
<b>52</b>	Test all memory (clear all extended memory to 0)
<b>53</b>	Clear password according to H/W jumper (Optional)
<b>55</b>	Display number of processors (multi-processor platform)
<b>57</b>	Display PnP logo Early ISA PnP initialization -Assign CSN to every ISA PnP device
<b>59</b>	Initialize the combined Trend Anti-Virus code
<b>5B</b>	(Optional Feature) Show message for entering AWDFLASH.EXE from FDD (optional)
<b>5D</b>	1. Initialize Init_Onboard_Super_IO 2. Initialize Init_Onboard_AUDIO
<b>60</b>	Okay to enter Setup utility; i.e. not until this POST stage can users enter the CMOS setup utility
<b>63</b>	Reset keyboard if Early_Reset_KB is not defined
<b>65</b>	Initialize PS/2 Mouse
<b>67</b>	Prepare memory size information for function call: INT 15h ax=E820h
<b>69</b>	Turn on L2 cache



<b>6B</b>	Program chipset registers according to items described in Setup & Auto-configuration table
<b>6D</b>	1. Assign resources to all ISA PnP devices 2. Auto assign ports to onboard COM ports if the corresponding item in Setup is set to "AUTO"
<b>6F</b>	1. Initialize floppy controller 2. Set up floppy related fields in 40:hardware
<b>75</b>	Detect & install all IDE devices: HDD, LS120, ZIP, CDROM ...
<b>76</b>	(Optional Feature) Enter AWDFLASH.EXE if: -AWDFLASH is found in floppy drive -ALT+F2 is pressed
<b>77</b>	Detect serial ports & parallel ports.
<b>7A</b>	Detect & install co-processor
<b>7C</b>	Init HDD write protect
<b>7F</b>	Switch back to text mode if full screen logo is supported -If errors occur, report errors & wait for keys -If no errors occur or F1 key is pressed to continue: Clear EPA or customization logo
<b>EBPOST.ASM starts</b>	
<b>82</b>	1. Call chipset power management hook 2. Recover the text font used by EPA logo (not for full screen logo) 3. If password is set, ask for password
<b>83</b>	Save all data in stack back to CMOS
<b>84</b>	Initialize ISA PnP boot devices
<b>85</b>	1. USB final Initialization 2. Switch screen back to text mode
<b>87</b>	NET PC: Build SYSID Structure
<b>89</b>	1. Assign IRQs to PCI devices 2. Set up ACPI table at top of the memory.
<b>8B</b>	1. Invoke all ISA adapter ROMs 2. Invoke all PCI ROMs (except VGA)
<b>8D</b>	1. Enable/Disable Parity Check according to CMOS setup 2. APM Initialization
<b>8F</b>	Clear noise of IRQs
<b>93</b>	Read HDD boot sector information for Trend Anti-Virus code
<b>94</b>	1. Enable L2 cache 2. Program Daylight Saving 3. Program boot up speed 4. Chipset final initialization. 5. Power management final initialization 6. Clear screen & display summary table 7. Program K6 write allocation 8. Program P6 class write combining
<b>95</b>	Update keyboard LED & typematic rate
<b>96</b>	1. Build MP table 2. Build & update ESCD 3. Set CMOS century to 20h or 19h 4. Load CMOS time into DOS timer tick 5. Build MSIRQ routing table
<b>FF</b>	Boot attempt (INT 19h)

## 5.1.2 AC2005 POST Code Definitions

POST (hex)	Description
<b>Power On Sequence</b>	
<b>8.1.</b>	Start power on sequence
<b>8.2.</b>	Enable ATX power supply
<b>8.3.</b>	ATX power supply ready
<b>8.4.</b>	DDR voltage ready
<b>8.5.</b>	Setup PWM for CPU core voltage
<b>8.6.</b>	Assert PWM for CPU core voltage
<b>8.7.</b>	Check CPU core voltage
<b>8.8.</b>	CPU core voltage ready
<b>8.9.</b>	Initial clock generator IC
<b>8.A.</b>	North Bridge chipset voltage ready
<b>8.B.</b>	AGP voltage ready
<b>8.C.</b>	3VDUAL voltage ready
<b>8.D.</b>	VDDA 2.5V voltage ready
<b>8.D.</b>	GMCHVTT voltage ready
<b>8.E.</b>	Check CPU fan speed
<b>8.F.</b>	Assert all power ready
<b>9.0.</b>	Complete µGuru initial process AWARD BIOS take over booting job
<b>Power Off Sequence</b>	
<b>9.1.</b>	Start power off sequence
<b>9.2.</b>	De-Assert all power
<b>9.3.</b>	De-Assert power on
<b>9.4.</b>	De-Assert LDT Bus power
<b>9.5.</b>	De-Assert PWM for CPU core voltage
<b>9.6.</b>	De-Assert CPU core voltage
<b>9.7.</b>	Check CPU core voltage
<b>9.8.</b>	De-Assert ATX power supply
<b>9.9.</b>	Complete power off sequence
<b>Others</b>	
<b>F.0.</b>	Button reset
<b>F.1.</b>	SoftMenu reset
<b>F.2.</b>	Power on sequence timeout
<b>F.3.</b>	Power off sequence timeout

## 5.2 Troubleshooting (How to Get Technical Support?)

### 5.2.1 Q & A

**Q: Do I need to clear the CMOS before I use a new motherboard to assemble my new computer system?**

A: Yes, we highly recommend that you clear the CMOS before installing a new motherboard. Please move the CMOS jumper from its default 1-2 position to 2-3 for a few seconds, and then back. When you boot up your system for the first time, follow the instructions in the user's manual to load the optimized defaults.

**Q: If my system hangs when I update the BIOS or set the wrong CPU parameters, what should I do?**

A: Whenever you update the BIOS or if the system hangs due to wrong CPU parameters setting, always clear CMOS jumper before booting up again.

**Q: Why does the system fail to boot up again right after a mechanical power-off?**

A: Please keep a 30-second interval between each mechanical power On/Off.

**Q: Why does the system fail to boot up and nothing displays on the screen after I did some over-clocking or non-standard settings inside the BIOS?**

A: It should not cause hardware or permanent damage to motherboard when BIOS settings were changed from default to over-clocking or non-standard status.

We suggest the following three troubleshooting methods to discharge CMOS data, recover the hardware default status, and then making the motherboard work again. There is no need to bother returning the motherboard to where you bought it from or go through an RMA process.

**Step 1.** Switch off the power supply unit and then switch it on again after one minute. If there is no power-switch on the power supply unit, disconnect its power cord for one minute and then reconnect.

Press and hold the <Insert> key on the keyboard, and press the power-on button to boot up system. If it works, release the <Insert> key and hit <Del> key to enter the BIOS setup page to apply the correct settings.

If the situation remains the same, repeat the procedures in Step 1 for three times, or try Step 2.

**Step 2.** Switch off the power supply unit or disconnect the power cord. Open the chassis cover. Locate the CCMOS jumper near the button battery. Change the jumper position from default 1-2 to 2-3 for one minute to discharge the CMOS data, and then put it back to default 1-2 position.

Close the chassis and switch on the power supply unit or plug in the power cord. Press the power-on button to boot up system. If it works, hit <Del> key to enter the BIOS setup page to do the correct settings.

If the situation remains the same, try Step 3.

**Step 3.** The same procedure as Step 2, but while discharging the CMOS data, pull out the ATX power connectors from motherboard and remove the button battery during CMOS discharge.

**Q: How to get a quick response for my request on technical support?**

A: Please carry out a simple troubleshooting before sending “**Technical Support Form**”:

**System boot-up fails after the system had been assembled:**

Check the motherboard’s supporting specifications first to see if all the key components attached in your system can meet.

To do so, you may:

- ✦ Remove all the unnecessary add-on devices (except the CPU, VGA card, DRAM, and Power Supply), and then reboot.
- ✦ If the trouble still exists, try another VGA card of different brand/model to see if the system will start.
- ✦ If the trouble still exists, try another memory module of different brand/model.
- ✦ If the trouble still exists, try another CPU and Power Supply.

If the system runs successfully, shut it down and start re-installing the interface cards and devices that were previously installed in the system. Re-install and start the system one at a time until the system won’t start.

**Malfunction in the OS:**

If the system hangs after resuming from S3 or some testing program, if the CPU cannot be recognized properly, if the display resolution mixed, or if a certain program cannot be executed, etc, you may:

- ✦ Upgrade the motherboard’s latest BIOS version.
- ✦ Upgrade the add-on device’s latest driver version.
- ✦ Check if there is any conflict in the “Control Panel/System Properties”.

**Q: How to fill in the “Technical Support Form”?**

A: To fill in this “**Technical Support Form**”, please refer to the following instructions:

- **Region:** Type in your country name.
- **E-mail:** Type in your contact E-mail information.
- **First name:** Type in your first name.
- **Last name:** Type in your last name.
- **Subject:** Type in the model name and the problem of your motherboard.  
Example 1: AA8XE and SCSI 29160 malfunction  
Example 2: AA8XE boot fails, POST code AF  
Example 3: AA8XE (system hang when S3 resume)
- **Motherboard:** Type in the model name and revision number of your motherboard.  
Example: AA8XE REV: 1.00
- **BIOS Version:** Type in the BIOS version of your motherboard. (You can find it on the screen during the POST sequence.)
- **CPU:** Type in the brand name and the speed (MHz) of your CPU. (Illustrate the over-clocking status if you had done so.)  
Example: Intel 650 3.4GHz (OC FSB=220MHz)
- **Memory brand:** Type in the brand and model name of your memory module.  
Example: Memory brand: Kingston (KVR533D2N4/1G)

- **Memory size:** Type in the size of your memory module.  
Example: 512M\* 4PCS
- **Memory configuration:** Type in the memory configuration in BIOS setting.  
Example: Memory Timing: 2.5-3-3-7 @533MHz
- **Graphics information:** Note Graphics card's brand, model and driver version
- **Graphics card:** Type in the brand and model name of your graphics card.  
Example: ATI RADEON X850 XT PE
- **Graphics driver version:** Type in the driver version of your graphics card  
Example: Catalyst 5.12V
- **Power supply maker:** Type in the brand and model name of your power supply unit.
- **Power supply wattage:** Type in the power wattage of your power supply unit.
- **Storage devices:** Type in the brand and specifications of your HDD drive and quantity. Specify if it was inserted on IDE (Master or Slave) or SATA ports, including the RAID allocation status.  
Example 1: WD Caviar WD600 60GB (on IDE2 master), Maxtor DiamondMax 10 SATA 300GB (on SATA 3)  
Example 2: Maxtor DiamondMax 10 SATA 300GB \*2 (on SATA 3, SATA 4 RAID 1)
- **Optical devices:** Type in the brand and specifications of your optical drives and quantity. Specify if it was inserted on IDE (Master or Slave) or SATA ports.
- **Other devices:** Indicate which add-on cards or USB devices that you *absolutely sure* are related to the problem. If you cannot identify the problem's origin, indicate all the add-on cards or USB devices inserted on your system.  
Example: AHA 29160 (on PCI 2), Sandisk Cruzer mini 256MB USB Flash-disk.
- **Operating system:** Indicate which OS and language version  
Example: Microsoft Windows XP SP2, English version  
Example: Microsoft Media Center Edition 2005, Korean version
- **Problem description:** Describe the problem of your system configuration. Indicate the steps to duplicate problem if possible.

See the next page for a blank Technical Support Form, or visit our website to fill in the form on line (<http://www.abit.com.tw/page/en/contact/technical.php>).

**Q. Is the motherboard dead? Do I need to return it to where I bought from or go through an RMA process?**

- A: After you had gone through the troubleshooting procedures, yet the problem still exists, or you find an evident damage on the motherboard. Please contact our RMA center. ([http://www2.abit.com.tw/page/en/contact/index.php?pFUN\\_KEY=18000&pTITLE\\_IMG](http://www2.abit.com.tw/page/en/contact/index.php?pFUN_KEY=18000&pTITLE_IMG))

## 5.2.2 Technical Support Form

Country:	
First name:	
Last Name:	
Subject:	
Motherboard:	
BIOS Version:	
CPU:	
Memory brand:	
Memory size:	
Memory configuration:	
Graphics card:	
Graphics driver version:	
Power supply maker:	
Power supply wattage:	
Storage devices:	
Optical devices:	
Other devices:	
Operating system:	
Problem description:	



## 5.2.3 ABIT Contact Information

---

### Taiwan Head Office

#### **ABIT Computer Corporation**

No. 323, Yang Guang St., Neihu, Taipei, 114, Taiwan  
Tel: 886-2-8751-8888  
Fax: 886-2-8751-3382

---

### North America, South America

#### **ABIT Computer (U.S.A.) Corporation**

2901 Bayview Drive, Fremont, CA 94538, U.S.A.  
Tel: 1-510-623-0500  
Fax: 1-510-623-1092  
Website: <http://www.abit-usa.com>  
RMA Center: <http://rma.abit-usa.com>

---

### U.K., Ireland

#### **ABIT Computer (U.K.) Corporation Ltd.**

Unit 3, 24-26 Boulton Road, Stevenage, Herts SG1 4QX, U.K.  
Tel: 44-1438-228888  
Fax: 44-1438-226333

---

### Austria, Czech, Romania, Bulgaria, Slovakia, Croatia, Bosnia, Serbia, Macedonia

#### **Asguard Computer Ges.m.b.H**

Schmalbachstrasse 5, A-2201 Gerasdorf / Wien, Austria  
Tel: 43-1-7346709  
Fax: 43-1-7346713

---

### Germany and Benelux (Belgium, Netherlands, Luxembourg), France, Italy, Spain, Portugal, Greece, Denmark, Norway, Sweden, Finland, Switzerland

#### **AMOR Computer B.V. (ABIT's European Office)**

Jan van Riebeeckweg 15, 5928LG, Venlo, The Netherlands  
Tel: 31-77-3204428  
Fax: 31-77-3204420

---

### Shanghai

#### **ABIT Computer (Shanghai) Co. Ltd.**

Tel: 86-21-6235-1829  
Fax: 86-21-6235-1832  
Website: <http://www.abit.com.cn>

---

### Poland

#### **ABIT Computer (Poland) Co. Ltd.**

Przedstawicielstwo w Polsce, ul. Wita Stwosza 28, 50-149 Wrocław  
Tel: 48 71 780 78 65 (Technical support/RMA)  
Tel: 48 71 718 19 70 (PR/Marketing)  
Fax: 48 71 780 78 66

---



**ABIT Computer Corporation**

<http://www.abit.com.tw>