



Express L768 and Express L1.5

HDSL Router/Bridge

USER MANUAL

Express L768
Express L1.5

1202192L1
1202192L2

61202192L1-1B
June 1998

Trademark:

DMS-100 is a trademark of Northern Telecom, Inc.

Ethernet is a trademark of Digital Equipment Corporation, Intel Corporation, and Xerox Corporation.

ExpertISDN (patent number 5,715,241) is a trademark of ADTRAN, Inc.

Macintosh is a registered trademark of Apple Computer, Inc.

Novell, NetWare, and Internetwork Packet Exchange (IPX) are registered trademarks of Novell, Inc.

Windows is a registered trademark of Microsoft Corporation.

5ESS is a registered trademark of AT&T.



901 Explorer Boulevard
P.O. Box 140000
Huntsville, AL 35814-4000
Phone: (256) 963-8000
© 1998 ADTRAN, Inc.
All rights reserved.
Printed in USA.

FCC regulations require that the following information be provided in this manual:

1. If this equipment causes harm to the telephone network, the telephone company may temporarily discontinue service. If possible, advance notification is given; otherwise, notification is given as soon as possible. The telephone company will advise the customer of the right to file a complaint with the FCC.
2. The telephone company may make changes in its facilities, equipment, operations, or procedures that could affect the proper operation of this equipment; advance notification and the opportunity to maintain uninterrupted service are given.
3. If experiencing difficulty with this equipment, please contact ADTRAN (see inside back cover) for repair and warranty information. The telephone company may require this equipment to be disconnected from the network until the problem is corrected, or it is certain the equipment is not malfunctioning.
4. This unit contains no user serviceable parts.

To ADTRAN service personnel: For continued protection against risk of fire, replace F1 with the same type and rating of fuse only: .2A, 250 V.

FEDERAL COMMUNICATIONS COMMISSION RADIO FREQUENCY INTERFERENCE STATEMENT

This equipment has been tested and found to comply with the limits for a Class A digital device, pursuant to Part 15 of the FCC Rules. These limits are designed to provide reasonable protection against harmful interference in a residential environment. This equipment generates, uses, and can radiate radio frequency energy and, if not installed and used in accordance with the instructions, may cause harmful interference to radio or TV reception, which can be determined by turning the equipment off and on. The user is encouraged to try to correct the interference by one or more of the following measures:

- Reorient or relocate the receiving antenna.
- Increase the separation between the equipment and receiver.
- Connect the equipment into an outlet on a circuit different from that to which the receiver is connected.
- Consult the dealer or an experienced radio/TV technician for help.

WARNING

Changes or modifications to this unit not expressly approved by ADTRAN will void the user's authority to operate the equipment.

CANADIAN EMISSIONS REQUIREMENTS

This digital apparatus does not exceed the Class A limits for radio noise emissions from digital apparatus as set out in the interference-causing equipment standard entitled "Digital Apparatus," ICES-003 of the Department of Communications.

Cet appareil numérique respecte les limites de bruits radioélectriques applicables aux appareils numériques de Class A prescrites dans la norme sur le matériel brouilleur: "Appareils Numériques," NMB-003 édictée par le ministre des Communications.

CANADIAN EQUIPMENT LIMITATIONS

Notice: The Canadian Industry and Science Canada label identifies certified equipment. This certification means that the equipment meets certain telecommunications network protective, operational, and safety requirements. The Department does not guarantee the equipment will operate to the user's satisfaction.

Before installing this equipment, ensure that it is permissible to be connected to the facilities of the local telecommunications company. The equipment must also be installed using an acceptable method of connection. In some cases, the company's inside wiring associated with a single-line individual service may be extended by means of a certified connector assembly (telephone extension cord). Compliance with the above conditions may not prevent degradation of service in some situations.

Repairs to certified equipment should be made by an authorized Canadian maintenance facility designated by the supplier. Any repairs or alterations made by the user to this equipment, or equipment malfunctions, may give the telecommunications company cause to request the user to disconnect the equipment.

Users should ensure for their own protection that the electrical ground connections of the power utility, telephone lines, and internal metallic water pipe system, if present, are connected together. This precaution may be particularly important in rural areas.



Users should not attempt to make such connections themselves, but should contact the appropriate electric inspection authority, or an electrician, as appropriate.

The **Load Number** (LN) assigned to each terminal device denotes the percentage of the total load to be connected to a telephone loop which is used by the device, to prevent overloading. The termination on a loop may consist of any combination of devices subject only to the requirement that the total of the Load Numbers of all devices does not exceed 100.

Table of Contents

Quick Startup Guide	1
Setting up the HDSL Line	1
Chapter 1. Understanding HDSL and the Express L768/L1.5	3
HDSL Overview	3
The Express L768/L1.5	4
Applications	5
Single User to Corporate LAN	5
Frame Relay Connectivity to ADTRAN Frame Port 768.....	6
Small Office - Home Office (SOHO) to Corporate LAN.....	7
Routing and Bridging with the Express L768/L1.5.....	8
Factory Default.....	8
Bridging.....	8
IP Routing	9
IPX Routing.....	9
Concurrent Routing And Bridging	9
Network Address Translation Mode.....	9
Front Panel.....	10
Indicators.....	10
Rear Panel	11
Configuration	11
Security.....	12
Chapter 2. Installation	13
HDSL Network Connection.....	13
T1 Overview	13
HDSL Overview.....	13
Local Area Network Connection	14
Chapter 3. Terminal Menu Operation and Structure	15
Terminal Menu Structure.....	15
Configuration	15
Status	17
Test.....	17
Logs.....	17
Utilities	17
Navigating the Terminal Menus	18
General Layout.....	18
Menu Path.....	18
Moving Around	18
Submenus [+] or [DATA].....	18
Activation Field <+>	18
Editable Data Field.....	18

Table of Contents

Read-Only Field.....	18
Navigation with the Keyboard.....	19
Security Levels	21
Configuration Menu	22
Configuration/System Info.....	22
System Name	22
System Location	22
System Contact.....	23
Firmware Revision.....	23
System Uptime	23
Date/Time.....	23
Configuration/WAN	24
WAN/HDSL.....	24
HDSL/Mode	24
HDSL/Channel Rate.....	24
HDSL/NEBEs	25
HDSL/FEBEs	25
WAN/L2 Protocol	25
Configuration/IP	26
IP/IP Address.....	26
IP/Subnet Mask	26
IP/Default Gateway	26
IP/Static Routes	27
Static Routes/Active	27
Static Routes/IP Address.....	27
Static Routes/Subnet Mask.....	27
Static Routes/Gateway.....	27
Static Routes/Hops	27
Static Routes/Private.....	27
IP/IP Router	28
IP Router/Mode	28
IP/RIP	28
RIP/Mode	28
RIP/Protocol.....	28
RIP/Method.....	28
RIP/Direction	29
RIP/V2 Secret	29
IP/NAT	29
NAT/DHCP Mode.....	29
NAT/DHCP Renewal Time.....	29
NAT/Web Server	29
NAT/Default IP.....	30
IP/DNS.....	30
DNS/Domain Name	30
DNS/Server 1.....	30
DNS/Server 2.....	30
IP/UDP Relay.....	31
UDP Relay/Mode.....	31

UDP Relay/UDP Relay List.....	31
UDP Relay List/Relay Address.....	31
UDP Relay List/UDP Port Type.....	31
UDP Relay List/UDP Port 1, UDP Port 2, UDP Port 3	31
IP/Proxy ARP	32
Configuration/IPX	33
IPX/Mode	33
IPX/Network.....	33
IPX/Frame Type	34
IPX/Seed Status	34
IPX/RIP Timer	34
IPX/SAP Timer	35
Configuration/Bridge.....	36
Bridge/Mode.....	36
Bridge/WAN IP Bridge	36
WAN IP Bridge/Network	37
WAN IP Bridge/Netmask	37
WAN IP Bridge/Triggered.....	37
WAN IP Bridge/Proxy ARP.....	37
Bridge/WAN IPX Bridge	37
WAN IPX Bridge/Network.....	38
WAN IPX Bridge/Frame Type	38
WAN IPX Bridge/Seed Status	38
WAN IPX Bridge/Triggered	38
Bridge/Spanning Tree	38
Spanning Tree/Mode	38
Spanning Tree/Priority	39
Spanning Tree/Maximum Age.....	39
Spanning Tree/Hello Time.....	39
Spanning Tree/Forward Delay.....	39
Spanning Tree/LAN Port	39
LAN Port/Active	39
LAN Port/Path Cost	40
LAN Port/Priority	40
Spanning Tree/Bridge Group 1	40
Bridge Group 1/Active	40
Bridge Group 1/Path Cost.....	40
Bridge Group 1/Priority.....	40
Spanning Tree/Bridge Group 2	40
Bridge Group 2/Active	40
Bridge Group 2/Path Cost.....	41
Bridge Group 1/Priority	41
Bridge/Address Table	41
Address Table/Aging.....	41
Address Table/Forward Policy	41
Configuration/Security	42
Security/Authentication.....	42
Security/Radius Server.....	43
Radius Server/Primary Server.....	43

Table of Contents

Radius Server/Secondary Server	43
Radius Server/UDP Port.....	43
Radius Server/Secret	43
Radius Server/Retry Count	43
Security/PPP	44
Security/Filter Defines.....	44
Filter Defines /MAC Filter Defines	45
Filter Defines /Pattern Filter Defines	45
Filter Defines /IP Filter Defines	46
Filter Defines /IPX Filter Defines.....	47
Configuration/Frame Relay.....	48
Frame Relay/Maintenance Protocol	49
Frame Relay/Polling Frequency.....	49
Frame Relay/DLCI Mapping.....	49
DLCI Mapping/Active	50
DLCI Mapping/DLCI.....	50
DLCI Mapping/IP Map.....	50
Map/Active	50
Map/IARP	51
Map/Far-End IP Address.....	51
Map/IP Netmask	51
Map/Link IP Address	51
Map/RIP Protocol.....	51
Map/RIP Method.....	52
Map/RIP Direction.....	52
IP Map/NAT	52
DLCI Mapping/IPX Map.....	52
IPX Map/Active	52
IPX Map/IARP.....	53
IPX Map/Link Network.....	53
DLCI Mapping/Bridge Map.....	53
Bridge Map/Active.....	53
Bridge Map/Bridge Group.....	53
DLCI Mapping/Filters	54
Filters/In from PVC.....	54
Filters/In Exceptions	54
Filters/Out to PVC.....	55
Filters/Out Exceptions.....	55
Configuration/PPP Profile.....	56
PPP Profile/Authentication	56
Authentication/Tx Method	57
Authentication/Tx Username	57
Authentication/Tx Password.....	57
Authentication/Rx Username	57
Authentication/Rx Password.....	57
PPP Profile/IP	58
IP/Mode	58
IP/NAT	58

IP/Route	58
Route/IP/Net	58
Route/Netmask	58
Route/Force IP	59
IP/RIP	59
RIP/Mode	59
RIP/Protocol	59
RIP/Method	59
RIP/Direction	59
RIP/Triggered	60
PPP Profile/IPX	60
IPX/Mode	60
IPX/Remote Network	60
IPX/Triggered	60
IPX/Type 20 Packets	60
PPP Profile/Bridge	61
Bridge/Mode	61
PPP Profile/PPP	61
PPP/VJ Compression	61
PPP/Max Config	62
PPP/Max Timer	62
PPP/Max Failure	62
PPP Profile/Filters	62
Filters/WAN-to-LAN (In)	62
Filters/In Exceptions	63
Filters/LAN-to-WAN (Out)	64
Filters/Out Exceptions	64
Configuration/Management	65
Management/Telnet	65
Telnet/Server Access	65
Telnet/User List	66
User List/Name	66
User List/Authen Method	66
User List/Password	66
User List/Idle Time	66
User List/Level	66
Management/SNMP	67
SNMP Access	67
SNMP/Communities	67
Communities/Name	67
Communities/Privilege	67
Communities/Manager IP	67
SNMP/Traps	68
Traps/Manager Name	68
Traps/Manager IP	68
Management/Maint Port	68
Maint Port/Password Protect	68
Maint Port/Password	68

Table of Contents

Maint Port/Baud Rate	68
Maint Port/Data Bits	69
Maint Port/Parity.....	69
Maint Port/Stop Bits.....	69
Configuration/Terminal Mode	69
Status Menu.....	70
Status/Sessions	71
Sessions/PPP Session.....	71
Sessions/DLCI Table.....	72
Sessions/Spanning Tree.....	73
Status/ARP Cache.....	73
Status/Bridge Table	74
Status/IP Routes.....	74
Status/IPX Routes	75
Status/IPX Servers.....	75
Status/WAN Stats	76
Status/LAN Stats.....	76
Status/IP Stats.....	77
Test Menu	78
Test Menu/Echo Request	78
Test Menu/2047 Loopback.....	78
Logs Menu.....	79
Logs/Sys log Host	79
Logs/PPP Log	79
PPP Log/Active	80
PPP Log/Wrap.....	80
PPP Log/Level	80
PPP Log/View.....	80
PPP Log/Clear	80
Logs/Connection Log.....	80
Connection Log/Active	80
Connection Log/Wrap.....	81
Connection Log/Level.....	81
Connection Log/View.....	81
Connection Log/Clear	81
Logs/Network Log.....	81
Network Log/Active.....	81
Network Log/Wrap	81
Network Log/Level.....	82
Network Log/View	82
Network Log/Clear	82
Utilities Menu	83
Utilities/Ping.....	83
Utilities/Telnet Client	84
Utilities/Upgrade Menu.....	84
Upgrade/Transfer Method.....	84
Upgrade/TFTP Host	84
Upgrade/Filename	84

Upgrade/Status	84
Upgrade/Start Transfer	85
Upgrade/Abort Transfer	85
Upgrade/TFTP Server	85
Utilities/Exit.....	85
Chapter 4. Specification	87
Specifications and Features.....	87
Network Interface	87
Ethernet Interface (LAN).....	87
Display	87
Environmental	87
Physical	87
Power	87
Appendix A. Loop Status Messages	89
Appendix B. Log Messages	91
Appendix C. SNMP	99
Appendix D. Connector Pinouts	103
Appendix E. Terminal Mode Commands.....	105
Glossary	109
Acronyms	119
Index	121

Table of Contents

List of Figures

Figure 1-1:	Express L768/L1.5.....	4
Figure 1-2:	Single User to Corporate LAN	5
Figure 1-3:	Frame Relay Connectivity to ADTRAN Frame Port 768	6
Figure 1-4:	SOHO to Corporate LAN.....	7
Figure 1-5:	Express L768/L1.5 Front Panels.....	10
Figure 1-6:	Express L768/L1.5 Rear Panel.....	11
Figure 3-1:	Top Level Terminal Menu.....	16
Figure 3-2:	Configuration/System Info Screen.....	22
Figure 3-3:	Configuration/WAN Screen	24
Figure 3-4:	Configuration/IP Screen	26
Figure 3-5:	Configuration/IPX Screen	33
Figure 3-6:	Configuration/Bridge Screen	36
Figure 3-7:	Configuration/Security Screen	42
Figure 3-8:	Configuration/Frame Relay Screen.....	48
Figure 3-9:	Configuration/PPP Profile Screen.....	56
Figure 3-10:	Configuration/Management Screen.....	65
Figure 3-11:	Status Screen.....	70
Figure 3-12:	Test Screen	78
Figure 3-13:	Logs Screen.....	79
Figure 3-14:	Utilities Screen	83

List of Figures

List of Tables

Table D-A:	IBM/AT Style EIA-232 Interface	103
Table D-B:	RJ-45 HDSL BRI U	103
Table D-C:	10BaseT Ethernet	104

List of Tables

Quick Startup Guide

SETTING UP THE HDSL LINE

The Express L768/L1.5 works over leased or “dry” copper provided by the local telephone company. See *Chapter 4* on page 87 for specifications on maximum distance. If the Express L768/L1.5 is to be used in a back-to-back configuration, the line mode must be different for each unit.

1. Connect a VT 100 async terminal, or personal computer with a terminal emulator running 9600 N-8-1, to the **MAINTENANCE** port.
2. Hold down the **Control** key and press **R**; then press **Enter** to display the top menu.
3. Using the arrow keys and **Enter** key to navigate the menu, go to the **Configuration/WAN/HDSL** menu. Enter the line mode as HTU-C or HTU-R. Each end of an HDSL circuit must be of opposite modes.
4. Set the rate of transfer that will be used. Both devices must be set at the same rate.
5. Use the left arrow key or the **Escape** key to go back up the menu tree. When asked to save HDSL parameters, type **y**.
6. Connect the HDSL line to the RJ-45 jack labeled **HDSL** on the rear panel. See *Appendix D* on page 103 for connector pinouts.
7. When the Loop LED(s) remain solid, the Express L768/L1.5 is in synchronization.
8. On the Express L768, the Link LED will illuminate to indicate that PPP has successfully negotiated.

Quick Startup Guide

Chapter 1

Understanding HDSL and the Express L768/L1.5

HDSL OVERVIEW

High Bit Rate Digital Subscriber Line (HDSL) is rapidly becoming the service providers' technology of choice for the deployment of T1 services: according to recent estimates, over 60% of today's T1 installations use HDSL technology. Instead of traditional methods requiring multiple T1 repeaters, HDSL allows the telephone companies to quickly deploy a T1 circuit over Carrier Serving Area (CSA) loops (9,000 feet on 26 AWG wire or 12,000 feet on 24 AWG wire) without the need for loop conditioning or repeater installation. The benefits HDSL offers over traditional T1 span lines represent large cost savings for the service provider because

- HDSL circuits can be deployed in days as opposed to weeks
- HDSL circuits can be deployed without the need for
 - line repeaters on CSA loops
 - binder group separation
 - bridge tap removal for bridge taps totaling less than 2,500 feet (no single bridge tap greater than 2,000 feet)
- HDSL circuits virtually eliminate cross talk and loop impairment problems
- Safer class A3 voltages eliminate need for special training or procedures.

Adtran provides a full line of HDSL products that are the price/performance leaders in the industry.

THE EXPRESS L768/L1.5

The Express L768/L1.5 is a standalone device that links two Local Area Networks (LANs) using a high-speed DSL two-wire or four-wire line. The Express L768 has a two-wire interface and operates up to 768 kbits per second. The Express L1.5 has a four-wire interface and operates up to 1.536 Mbits per second. The Express L1.5 is compatible with the Express L768 in a two-wire mode if the rate is 768K and below.

See Figure 1-1 for an illustration of the Express L768/L1.5. The 10BaseT connector operates at 10 Mbits per second half duplex and accepts standard ethernet packets encapsulated using IEEE 802.3 or Ethernet II (DIX). Because the 10BaseT is a four-wire interface, a crossover switch permits the user to connect to either a hub-concentrator or network interface card without the need for special cabling. The maintenance port can connect to any asynchronous terminal emulating a VT 100 terminal for configuration.

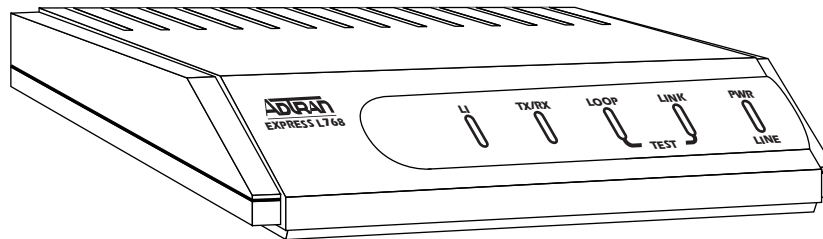

L768

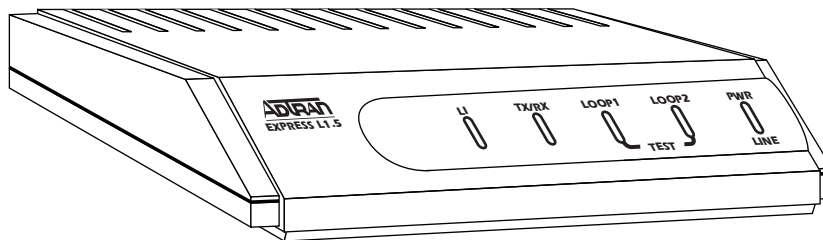

L1.5

Figure 1-1
Express L768/L1.5

Applications

Single User to Corporate LAN

- Telecommuter/Home Office Access to the corporate LAN
- Single device access
- User Datagram Protocol (UDP) broadcasts are “relayed” to corporate LAN.
- Client device can obtain the Internet Protocol (IP) address dynamically using Dynamic Host Configuration Protocol (DHCP).
- Compatible with popular central site LAN access devices

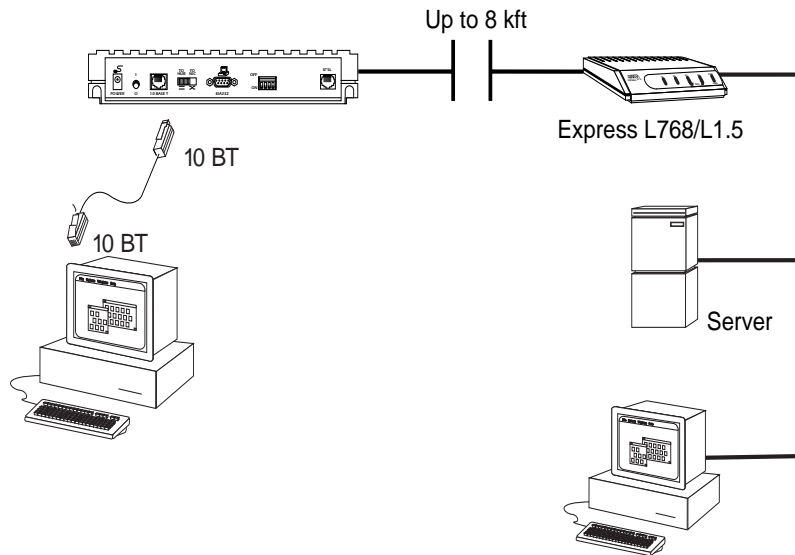

Figure 1-2
Single User to Corporate LAN

Frame Relay Connectivity to ADTRAN Frame Port 768

- Telecommuter/Home Office Access to the corporate LAN
- Access to any other router within the Frame Relay Network
- User Datagram Protocol (UDP) broadcasts are “relayed” to corporate LAN
- FramePort 768 (part no. 1100048L1) provides concentration of up to 24 SDSL interfaces into a single DS-1

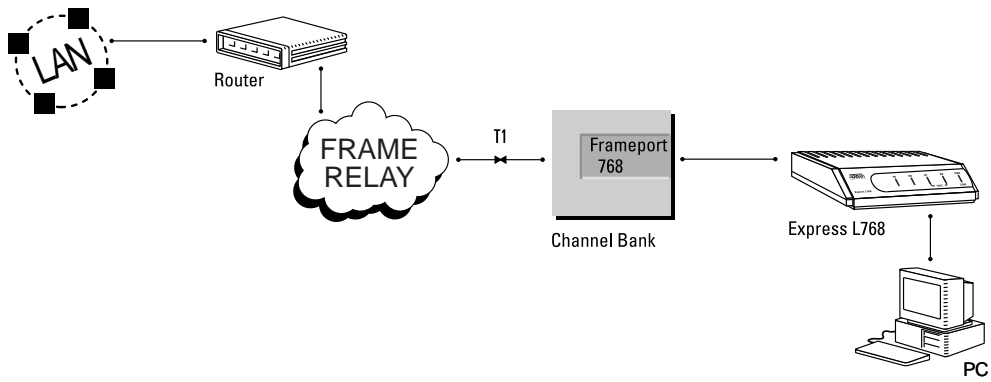

Figure 1-3
Frame Relay Connectivity to ADTRAN Frame Port 768

Small Office - Home Office (SOHO) to Corporate LAN

- Connects the small office or home office to the corporate LAN
- Routes IP and Internet Packet Exchange (IPX) traffic from multiple devices to the corporate LAN
- Bridges all non-routed traffic (e.g., AppleTalk)
- Low cost alternative to buying a high-end router
- Compatible with popular central site LAN access devices

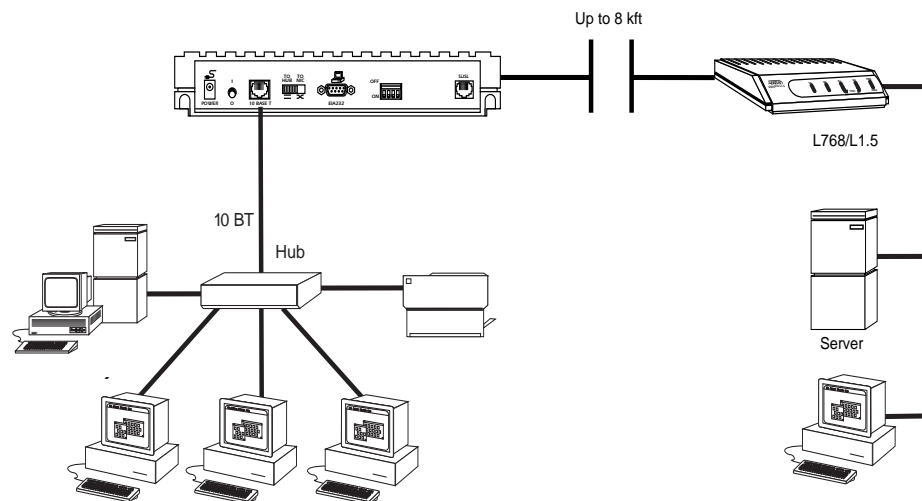

Figure 1-4
SOHO to Corporate LAN

The Express L768/L1.5 provides the following basic functions:

1. **LAN Bridge:** Bridging provides a point-to-point connection between two LANs. The bridge learning function scans the source and destination media access control (MAC) addresses of all packets on its local LAN and determines which packets should be transmitted over the HDSL link. Applications include connectivity between single user or small offices to corporate LANs. The Express L768/L1.5 uses the Spanning Tree Algorithm (IEEE 802.1d-ISO/IEC10038), which provides a loop-free topology and redundancy.

2. **IP Router:** The Express L768/L1.5 can function as an IP router using the Routing Information Protocol (RIP) for advertising and learning routes among other routers. Static routes may also be entered into the routing table.
3. **IPX Router:** IPX routers and services can be exchanged between the Express L768/L1.5 and other devices using RIP and Service Advertising Protocol (SAP). Watch dog serialization filtering and spoofing can permit the ISDN to be idle during no application traffic periods.
4. **Network Address Translation (NAT):** Single networks can connect to the Internet with this function. The Express L768/L1.5 translates outgoing IP packets over the HDSL to the IP router at the Internet Service Provider. Many popular Internet applications are supported.
5. **PPP or Frame Relay:** The layer two protocol used to transfer packets can be PPP or Frame Relay (RFC 1490). PPP allows a point-to-point connection, whereas Frame Relay can provide up to ten permanent virtual circuits.

Routing and Bridging with the Express L768/L1.5

The Express L768/L1.5 is a Router and Transparent Learning Bridge. Its features can be easily configured and used once several basic concepts are understood.

Factory Default

The Express L768/L1.5 comes from the factory configured for MAC Bridging, IP routing and IPX routing with no filters or connection information defined. An IP address of 10.0.0.1 with a network mask of 255.255.255.0 is preloaded. The factory default layer two configuration is PPP, which provides the least amount of reconfiguration due to its negotiation-oriented nature.

Bridging

In Bridge Mode, the Express L768/L1.5 can be used to connect two LAN segments. In this mode, all protocols are supported because they are transported across the HDSL link at the MAC layer. The Spanning Tree Algorithm can be used to guarantee a loop-free topology. MAC addresses are “learned” by each Express L768/L1.5 to prevent non-WAN packets from being bridged.

IP Routing

The Express L768/L1.5 operates as an IP router when the **Configuration/IP/IP Router/Mode** option is configured to **On**. In PPP mode, the Express L768/L1.5 uses an IP unnumbered WAN interface; the IP address and mask assigned to the unit's LAN interface apply to all routing and IP operations for the unit. In Frame Relay mode, each PVC can be specified as numbered or unnumbered links. If a default gateway is specified on the network of the Ethernet interface, the unit attempts to reach the gateway through that interface. If no default gateway is specified (i.e., 0.0.0.0) the WAN interface becomes the default gateway (recommended for remote applications when there are no other routers on the remote LAN).

IPX Routing

Network routes and services are learned and advertised using Novell's RIP and SAP.

Concurrent Routing And Bridging

The Express L768/L1.5 can route IP and IPX as well as bridge non-IP/IPX packets simultaneously. The PPP profile will by default negotiate PPP network protocols to support the transmission and reception of IP, IPX, and Bridge packets. If the PPP peer does not accept a protocol, the Express L768/L1.5 will fall back to any combination of routing and bridging.

Network Address Translation Mode

NAT is a special mode of operation in which the Express L768/L1.5 obtains a dynamically assigned IP address from the peer router (typically an Internet Service Provider). This allows a network of computers to appear as a single IP address.

NAT is enabled if the layer two protocol is PPP and the PPP profile has the IP parameter **NAT** set to **Yes**, or the layer two protocol is Frame Relay and a DLCI mapping has the **IP Map/Nat** parameter set to **Yes**. The network computer's IP stack may use DHCP to request an IP address, default gateway address, and domain name server addresses from the Express L768/L1.5.

Front Panel

Figure 1-5 shows the front panel of the Express L768/L1.5. The indicators are divided into LAN functions, WAN functions, and Test functions.

Indicators

TX/RX	Flashes when transmitting and receiving data on the 10BaseT connector.
LI	Link integrity. Illuminates when there is a good connection between the Express L768/L1.5 and the Hub/NIC card.
LOOP/LOOP1	Flashes when loop 1 (pins 1 and 2 on RJ-45) is not in sync. Solid when loop 1 is in sync.
LINK/LOOP2	On Express L768: Illuminates when either PPP or Frame Relay has an active connection. On Express L1.5: Flashes when loop 2 (pins 4 and 5 on RJ-45) is not in sync. Solid when loop 2 is in sync.

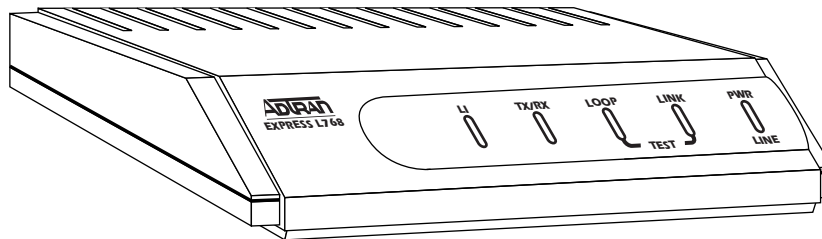

L768

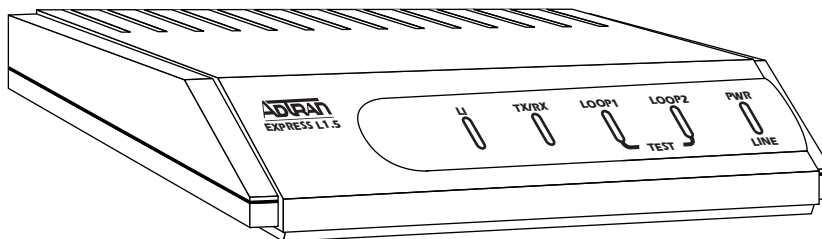

L1.5

Figure 1-5
Express L768/L1.5 Front Panels

Rear Panel

The Express L768/L1.5 has one RJ-45 jack, labeled **HDSL**, on the rear panel for network connection (see Figure 1-6). There are two sets of switches on the back panel. The **TO HUB/TO NIC** switch allows the Express L768/L1.5 to connect directly to a Network Interface Card (NIC) or a HUB without the need for special cabling. The **OFF/ON** switch block is for factory default and firmware downloading. With switch 1 in the up or **OFF** position, the Express L768/L1.5 will immediately go into a download mode when power is enabled. Switch 1 must be in the down or **ON** position in order to boot up normally. Switch 2 in the up or **OFF** position will force the entire configuration to be factory default-ed.

The Express L768 transfers data up to 768 kbps over a two-wire facility. The Express L1.5 transfers data up to 1.536 Mbps over a four-wire facility. This type of service is a permanent connection between endpoints or between the unit and the Frame Relay cloud. It is sometimes referred to as a leased connection, a dedicated connection, a nailed-up connection, or a private circuit. Leased connection or leased line is used in this manual to represent these types of services.

1202192L1/1202192L2

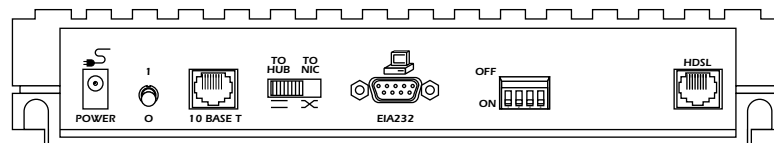

Figure 1-6

Express L768/L1.5 Rear Panel

Configuration

The Express L768/L1.5 is configured using a menu-based interface. This interface can be accessed via the maintenance port using any asynchronous VT 100 terminal or personal computer running a terminal emulation program, or via the LAN using a Telnet client program. To use the Telnet interface, the Express L768/L1.5 must first have an IP address programmed into it via the maintenance port. The factory default is 10.0.0.1.

Security

Security on network devices is a major concern for almost anyone with a network. The Express L768/L1.5 provides many tools for securing the local network from hostile users. Connections can be authenticated using passwords. A RADIUS client can also be used.

The Telnet configuration can also be protected using the same authentication methods. Each menu item in the Express L768/L1.5 has a security level associated with it. A telnet session is assigned a privilege level which determines which menu items are accessible to the telnet client. See *Security Levels* on page 21 (in Chapter 3) for more information on menu security levels.

Filters can be defined to prevent certain addresses or protocols from being transferred from LAN-to-WAN, WAN-to-LAN, or WAN-to-WAN.

Chapter 2

Installation

After unpacking the unit, immediately inspect it for possible shipping damage. If damage is discovered, file a claim immediately with the shipping carrier; then contact the ADTRAN Customer and Product Service (CAPS) department (see inside back cover for information).

HDSL NETWORK CONNECTION

T1 Overview

The T1 digital communications link has been used by telephone companies (telcos) for transmitting voice since the early sixties. The D4 channel bank is a T1 digital carrier system that was introduced in the mid-seventies and is still widely used by telcos. Communication demands of businesses continued to grow to the point that the telcos began offering T1 service directly to the public. D4 channel banks began to be used for T1 in corporate network topographies for voice. The advances in computer development also created a demand for T1 data communication which now is a large part of the T1 traffic.

T1 is a digital service that is delivered to the user over two pairs of wires from the service provider. The signal operates at 1.544 Mbps and is usually extended by repeaters that are installed about every mile after the first 6000 feet. The T1 signal is divided into 24 time slots (DS0s) which operate at 64 kbps. Each time slot is occupied by digitized voice or by data.

HDSL Overview

T1 service traditionally has been delivered from the service provider with an office repeater over metallic facilities with an alternate mark inversion (AMI) scheme. If the customer is beyond 3000 feet, a T1 loop repeater is used with additional repeaters spaced at 6000 feet.

A new technology has been developed for the telcos for delivery of T1 service. The technology is known as high-bit-rate digital subscriber line (HDSL). HDSL employs a 2B1Q modulation technique across the same types of pairs traditionally encountered with metallic T1 delivery systems. HDSL satisfies the telco distance requirements without the use of repeaters.

LOCAL AREA NETWORK CONNECTION

The Express L768/L1.5 has a 10BaseT connector that provides half-duplex 10 Mbps operation over a four-wire twisted pair. Place the switch in the **TO HUB** position when connecting to a 10BaseT concentrator or Hub. Place the switch in the **TO NIC** position when connecting directly to a computer's 10BaseT network interface card.

Other types of ethernet interfaces (i.e., AUI, 10Base2, etc.) can be accommodated by obtaining an appropriate converter.

Chapter 3

Terminal Menu Operation and Structure

TERMINAL MENU STRUCTURE

The Express L768/L1.5 uses a multilevel menu structure containing both menu items and data fields. All menu operations and data display in the terminal menu window. The Express L768/L1.5 is shipped in the Factory Default configuration. Connect any VT 100 or VT 220 type terminal emulator to the maintenance port. The default rate is 9600 baud 8-N-1. The terminal emulator can flow the Express L768/L1.5 off using software flow control. Hardware flow control is not used.

The opening menu (the Main menu, or top-level menu) is the access point to all other operations. Each Main menu item has several functions and sub-menus to identify and access specific parameters. *Figure 3-1* on page 16 shows the top-level terminal menu.



In order to edit items in the terminal menus, you must have the appropriate security level. Each menu description in this section indicates the required security level required for write access. The maintenance port is always at security level 0, giving full access to all configuration items.

The Main menu contains the following options.

Configuration

The Configuration menu provides options to set up the operational configuration for the Express L768/L1.5. See the section *Configuration Menu* on page 22 for detailed information on the available options.

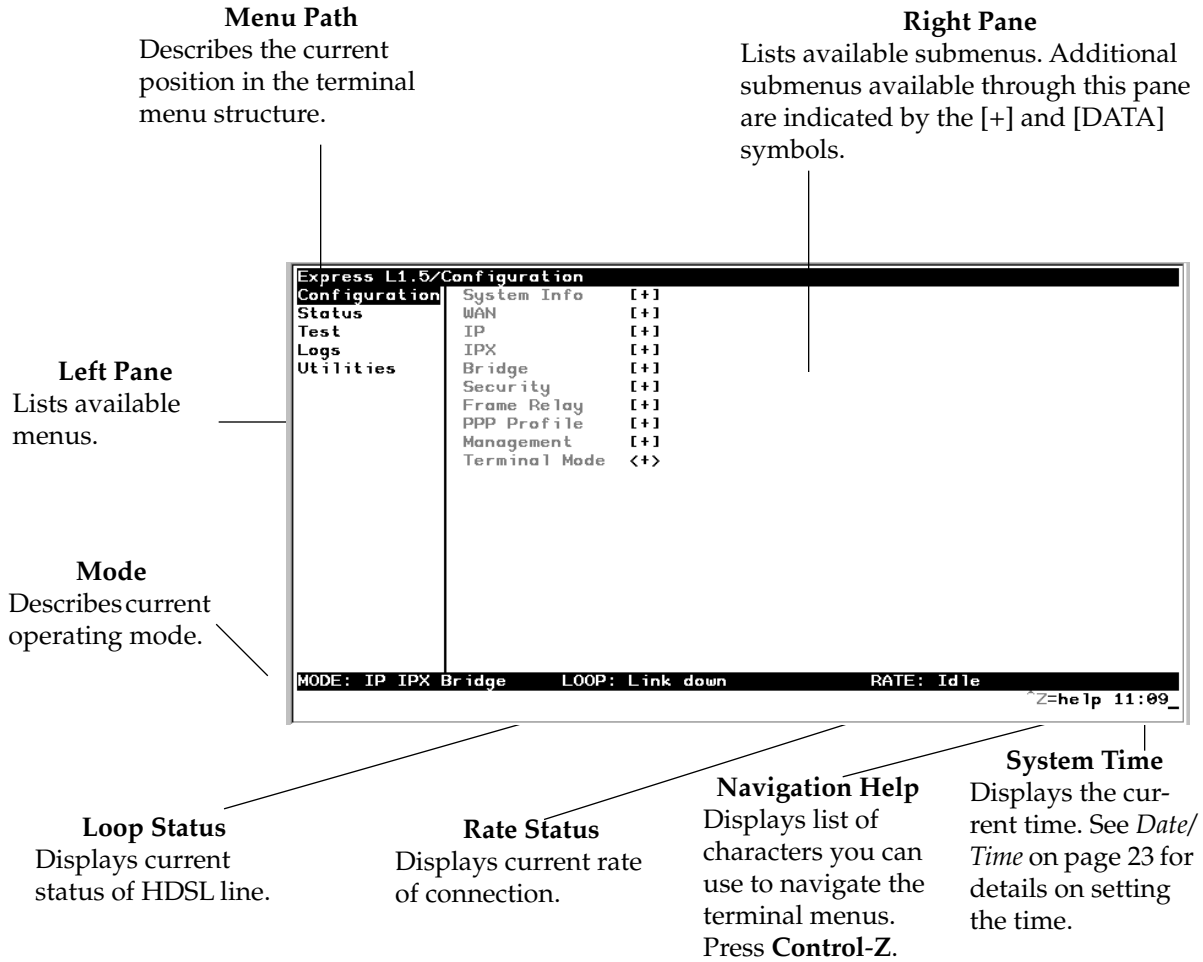

Figure 3-1
Top Level Terminal Menu

Status

The Status menu provides options to review and monitor the status of the Express L768/L1.5 system. See the section *Status Menu* on page 70 for detailed information on the available options.

Test

The Test menu can be used for performing diagnostic testing of the Express L768/L1.5. See the section *Test Menu* on page 78 for detailed information on the tests available.

Logs

The Logs menu can be used for viewing the operational logs for the Express L768/L1.5. See the section *Logs Menu* on page 79 for detailed information on the available options.

Utilities

The Utilities menu provides tools for system diagnostics and upgrading the Express L768/L1.5. See the section *Utilities Menu* on page 83 for detailed information on the available options.

NAVIGATING THE TERMINAL MENUS

The following sections provide information on how to navigate through the terminal menus.

General Layout

When you first start a terminal mode session, the screen shown in *Figure 3-1* on page 16 displays. The screen is divided into left and right panes. The left pane shows the current list of submenus, while the right pane shows the contents of a selected submenu.

Menu Path

The top line of the display shows this session's current position (path) in the menu tree. *Figure 3-1* on page 16 shows the top menu level with the cursor on the Configuration submenu, so the path display shows **Express XLT/Configuration**.

Moving Around

Press **Tab** or the right arrow key to move the cursor from the left pane to the right pane. Press **Tab** or the left arrow key to move the cursor from the right pane back to the left pane. Use the up and down arrows to move around within each pane. Press **Enter** to activate a menu. Press the left arrow key or the **Escape** key to go back up the menu. The following options display throughout the menus.

Submenus [+] or **[DATA]**

Menus that display **[+]** or **[DATA]** indicate that more items are available when selected.

Activation Field <+>

Menus that display **<+>** indicate that an action is to be taken, such as activating a test.

Editable Data Field

A highlighted menu item indicates that you can enter data in that field.

Read-Only Field

An underlined field is a display field that contains read-only information.

Navigation with the Keyboard

You can use different keystrokes to navigate through the terminal menu. Press **Control-Z** to activate a pop-up screen with the available keystrokes. The following section provides a list of the available keystrokes and the results:

General Navigation

H	Returns to the home screen.
J	Jumps between two menu items. Press J while on a menu item of interest, and you will jump back to the main screen. Go to another menu item of interest, Press J , and you will jump back to the screen that was displayed the first time you pressed J . Press J anytime you want to jump between these items.
Arrow Keys	Selects items and moves between the left and right panes. The left arrow key allows you to go back up the menu.
Enter	Activates an item or moves into submenu.
Escape	Cancels an edit. Allows you to go back up the menu. Also will dismiss the pop-up help screens.
Tab	Moves between the left and right panes.
A	Moves to the top of a screen.
Z	Moves to the bottom of a screen.
Backspace	Ascends one menu level.

Session Management

Control-L	Logs out of the session.
Control-S	Invalidates the password entry and returns to the login screen. The Password prompt will display.
Control-R	Refreshes the screen. To save time, only the portion of the screen that has changed is refreshed. This option should be necessary only if the display picks up incorrect characters.

Configuration

- F** Restores factory default settings. This setting restores the factory defaults based on the location of the cursor. Entire submenus can be factory defaulted.
- C** Copies selected items to the clipboard. The amount of information you can copy depends on the cursor location when you press **C**. For example, if the cursor is over an editable field, only that item is copied. If the cursor is over the index number of a list, then all of the items in the row of the list are copied. For example, if the cursor is over the **Num** field in the Frame Relay Mapping screen, all of the information associated with the Map entry is copied.
- P** Pastes the item stored in the clipboard, if the information is compatible. You must confirm all pastes except those to a single editable field.
- >** For certain types of fields, when you paste information into the field, the value increments by 1.
- <** For certain types of fields, when you paste information into the field, the value decrements by 1.
- I** Inserts a new item in a list. For example, add a new item to the Connection List by pressing **I** while the cursor is over the index number.
- D** Deletes a list item. For example, delete an item from the Connection List by pressing **D** while the index number is active.

Security Levels

Each menu item on the configuration screens has an associated security level. The security level ranges from 0 (highest security level) to 5 (lowest security level). This level determines whether a Telnet session can access that menu item. The Telnet session is assigned a security level set by the user. Passwords can only be accessed as security level 0. The maintenance port is always at security level 0.

The security levels are assigned as follows:

Level

0	Access all parameters including passwords
1	Access all parameters except passwords
2	Access all parameters except passwords and authentication methods
3	Access all parameters except passwords, authentication methods, and ISDN parameters
4	Access only test and status menus
5	Access status menus only

CONFIGURATION MENU

Configuration/System Info

The System Info menu provides basic information about the unit and displays data fields for editing information. Figure 3-2 displays the submenus available under this menu item.

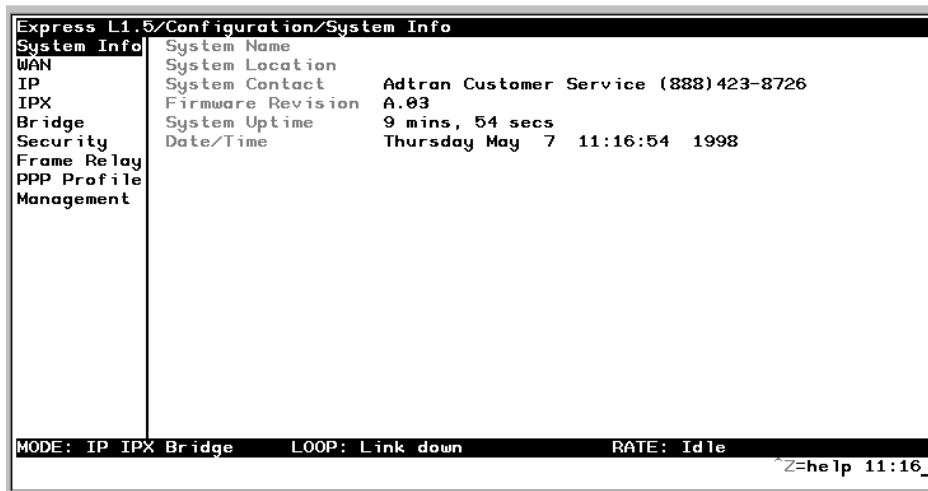

Figure 3-2
Configuration/System Info Screen

System Name

Write security: 3; Read security: 5

Provides a user-configurable text string for the name of the Express L768/L1.5. This name can help distinguish between different installations. You can enter up to 31 alpha-numeric characters in this field, including spaces and special characters (such as an under bar). The system name is also used for PPP authentication and IPX service name.

System Location

Write security: 3; Read security: 5

Provides a user configurable text string for the location of the Express L768/L1.5. This helps to keep track of the physical location of the unit. You can enter

up to 31 alpha-numeric characters in this field, including spaces and special characters (such as an under bar).

System Contact

Write security: 3; Read security: 5

Provides a user-configurable text string for the contact name. This field can contain a name, phone number, or e-mail address of a person responsible for the Express L768/L1.5. You can enter up to 31 alpha-numeric characters in this field, including spaces and special characters (such as an under bar).

Firmware Revision

Read security: 5

Displays the current firmware revision level of the Express L768/L1.5. This field is a read-only field.

System Uptime

Read security: 5

Displays the length of time the Express L768/L1.5 has been running since power up or reset. This field is a read-only field.

Date/Time

Write security: 3; Read security: 5

Displays the current date and time as programmed in the real-time clock. This field can be edited. Enter the time in 24-hour format (such as 23:00:00 to represent 11:00 PM). Enter the date in mm-dd-yyyy format (for example, 09-30-1997).

Configuration/WAN

The WAN menu is used to set up the ISDN parameters for the Express L768/L1.5. Figure 3-3 shows the WAN menu.

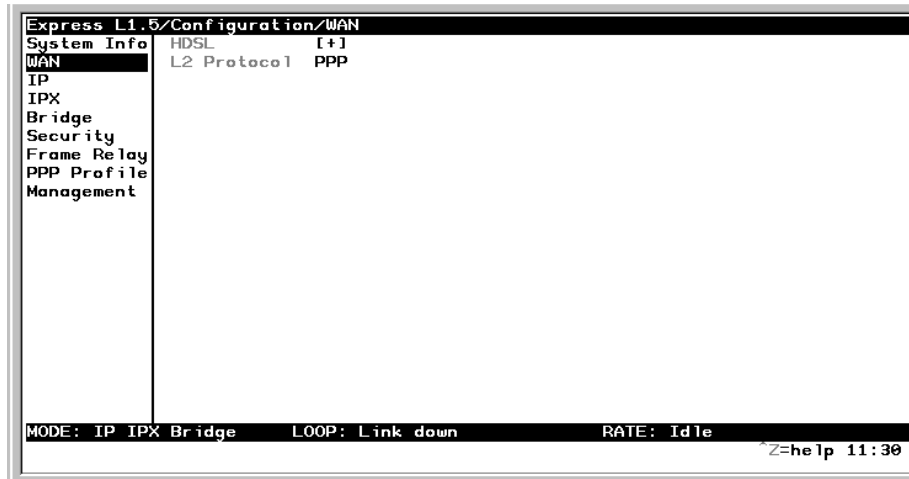

Figure 3-3
Configuration/WAN Screen

WAN/HDSL

Write security: 2; Read security: 5
Selects the mode the HDSL line is in.

HDSL/Mode

Write security: 2; Read security: 5
The Express L768/L1.5 can be in two modes: HDSL Terminal Unit-Central (HTU-C) or HDSL Terminal Unit-Remote (HTU-R) (def). For HDSL synchronization, one unit must be HTU-C and one must HTU-R.

HDSL/Channel Rate

Write security: 2; Read security: 5
Determines the rate at which data is transferred over the HDSL link. Possible rates are 128K, 192K, 256K, 320K, 384K, 448K, 512K, 576K, 640K, 704K, 768K, and 1.536M (available with Express L1.5 only).

HDSL/NEBEs

Read security: 5

This contains the number of Near-End-Block-Errors (NEBEs) that have been detected by the Express L768/L1.5's HDSL circuitry. Continuous errors can indicate a line problem, but a burst at one time is normal.

HDSL/FEBEs

Read security: 5

This contains the number of Far-End-Block-Errors (FEBEs) that have been detected by the HDSL circuitry on the other end of the link. Continuous errors can indicate a line problem, but a burst at one time is normal.

WAN/L2 Protocol

Write security: 3, Read security: 5

This parameter specifies the layer 2 data link layer transport used. When selected as **PPP** (def), the Express L768/L1.5 will negotiate PPP over the HDSL interface. This would be used mainly for campus wiring applications. Parameters for controlling the PPP negotiation are in the **Configuration/PPP Profile** menu. **Frame Relay** should be selected when the Express L768/L1.5 is connected to a Frame Relay switch. The **Configuration/WAN/Frame Relay** menu is used for controlling the Frame Relay parameters.

Configuration/IP

The IP menu is used to set up the IP parameters for the Express L768/L1.5. Any general IP-related configuration item is under this menu. Figure 3-4 shows the IP menu.

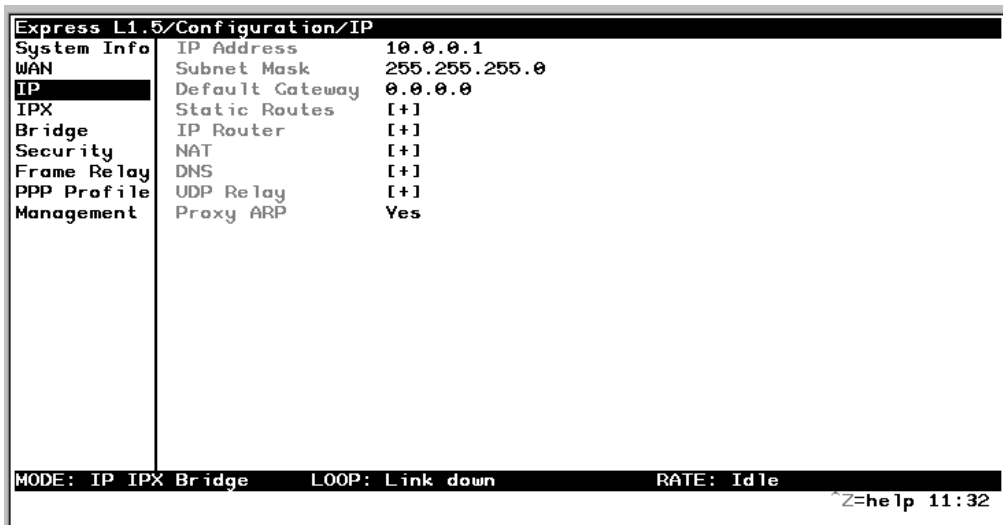

Figure 3-4
Configuration/IP Screen

IP/IP Address

Write security: 2; Read security: 5

The IP address assigned to the Express L768/L1.5's Ethernet port is set here. This address must be unique within the network. Factory default is 10.0.0.1.

IP/Subnet Mask

Write security: 2; Read security: 5

The IP network mask to be applied to the Express L768/L1.5's Ethernet port is set here. Factory default is 255.255.255.0.

IP/Default Gateway

Write security: 3; Read security: 5

The default gateway is used by the Express L768/L1.5 for sending IP packets

whose destination address is not found in the route table. If this address is all zeros, then the first WAN connection becomes the default gateway.

IP/Static Routes

Static Routes can be inserted under this menu.

Static Routes/Active

Write security: 4; Read security: 5

Adds this static route entry to the IP routing table when set to **Yes** (def) and removes it (if it was previously added) if set to **No**.

Static Routes/IP Address

Write security: 4; Read security: 5

This is the IP address of the host or network address of the device being routed to.

Static Routes/Subnet Mask

Write security: 4; Read security: 5

This mask determines the bits in the previous IP address that are used. If this is to be a host route, it must be set to all ones (255.255.255.255).

Static Routes/Gateway

Write security: 4; Read security: 5

This is the IP address of the router to receive the forwarded IP packet.

Static Routes/Hops

Write security: 4; Read security: 5

This is the number of router hops required to get to the network or host. Maximum distance is 15 hops.

Static Routes/Private

Write security: 4; Read security: 5

When set to **No**, the Express L768/L1.5 will advertise this static route using RIP. Otherwise, setting to **Yes** means that the route is kept private.

IP/IP Router

The IP router is configured under this menu as follows.

IP Router/Mode

Write security: 3; Read security: 5

When this option is set to **On** (def), the Express L768/L1.5 will advertise and listen to routes from other IP routers. If **Off**, the route table is still used but only static routes are used for routing IP packets and only the Ethernet port is used. IP packets can be sent over the WAN, but only when bridged.

IP/RIP

Write security: 3; Read security: 5

The Routing Information Protocol (RIP) is supported by the Express L768/L1.5. The following parameters are required for setting up the mode on the Ethernet port:

RIP/Mode

Write security: 3; Read security: 5

This option turns RIP **On** (def) or **Off**

RIP/Protocol

Write security: 3; Read security: 5

Version can be **V1** (def) or **V2**

RIP/Method

Write security: 3; Read security: 5

Split Horizon - Only routes not learned on the Ethernet port are advertised.

Poison Reverse (def) - All routes are advertised, including routes learned from the Ethernet port. These routes are poisoned.

None - All routes are advertised, including routes learned from the Ethernet port. No attempt is made to poison these routes.

RIP/Direction

Write security: 3; Read security: 5

Tx and Rx (def)- RIP advertisements are transmitted and listened to on the Ethernet port.

Tx only - RIP advertisements are transmitted and not listened to.

Rx only - RIP advertisements are listened to but not transmitted.

RIP/V2 Secret

Write security: 0; Read security: 0

This is a text string used for authenticating advertised routes.

IP/NAT

The Network Address Translation general parameters are set up under this menu.

NAT/DHCP Mode

Write security: 3; Read security: 5

When this option is set to **On**, the Express L768/L1.5 acts as a DHCP server and will dynamically assign IP, network mask, default gateway, and DNS addresses to any device which transmits a broadcast DHCP request. The addresses assigned are based on the Express L768/L1.5's own IP address and will be within the same network. This mode is most commonly used with the NAT functionality. The default is **Off**.

NAT/DHCP Renewal Time

Write security: 3; Read security: 5

This is the number of hours that the DHCP server should allow the device before it is required to send a new DHCP request. The default is 15 hours, and 0 represents an infinite lease.

NAT/Web Server

Write security: 3; Read security: 5

This is the IP address of a web server on the Ethernet network. When an active NAT connection is made to the Internet, any HTTP, FTP, or SMTP server requests from the WAN are translated and sent to this web server. Normally,

communication across NAT must be initiated from the LAN side of the Express L768/L1.5. Web Server allows a single machine on the NAT side to be accessed from the Internet side of NAT. This provides outside access to a web-server, mail, or ftp server.

NAT/Default IP

This is the IP address used by the Express L768/L1.5 for Network Address Translation when nothing is assigned during the PPP negotiation when PPP mode is active or when nothing is specified in the DLCI Mapping's Link IP Address.

IP/DNS

The Domain Name Server parameters used by the Express L768/L1.5 are specified here. The DNS server addresses can be exchanged between PPP peers. When a connection occurs and IPCP is negotiated, the Express L768/L1.5 will get the DNS server addresses from the PPP peer. If the configured DNS server addresses (**Server 1** and **Server 2**) are all zeros, the addresses from the PPP peer are used. In NAT mode, the PPP peer's DNS addresses are always used. The DNS addresses set in **Server 1** and **Server 2** are offered to a PPP peer if so requested.

DNS/Domain Name

Write security: 3; Read security: 5

This is a text string used to represent the domain name used by the Express L768/L1.5.

DNS/Server 1

Write security: 3; Read security: 5

This is the IP address for the primary DNS device. It is the first server that domain name requests are sent.

DNS/Server 2

Write security: 3; Read security: 5

This is the IP address for the secondary DNS device. It is used as a back-up in case the primary address does not respond to the request.

IP/UDP Relay

The Express L768/L1.5 can be configured as a relay agent for UDP broadcast packets. Normally, a router will not forward UDP broadcast packets. However, many network applications use UDP broadcasts to configure addresses, host names, and other information. If hosts using these protocols are not on the same network segment as the servers providing the information, the client programs will not receive a response without enabling the UDP relay agent.

UDP Relay/Mode

Write security: 3; Read security: 5

When this option is set to **On** (def), the Express L768/L1.5 will act as a relay agent.

UDP Relay/UDP Relay List

Up to four relay destination servers can be specified in this list.

UDP Relay List/Relay Address

Write security: 3; Read security: 5

This is the IP address of the server that will receive the relay packet.

UDP Relay List/UDP Port Type

Write security: 3; Read security: 5

Standard (def) - The following standard UDP protocols are relayed when set: DHCP, TFTP, DNS, NTP (Network Time Protocol, port 123), NBNS (NetBIOS Name Server, port 137), NBDG (NetBIOS Datagram, port 138), and BootP.

Specified - When set, the UDP port (1 to 65535) can be specified in the UDP Port columns. (up to a maximum of three per server)

UDP Relay List/UDP Port 1, UDP Port 2, UDP Port 3

Write security: 3; Read security: 5

UDP Port 1, UDP Port 2, and UDP Port 3 are used for specifying UDP ports to be relayed. These fields only apply when **UDP Port Type** is set to **Specified**.

IP/Proxy ARP

Write security: 4; Read security: 5

This feature allows the network portion of a group of addresses to be shared among several physical network segments. The ARP protocol itself provides a way for devices to create a mapping between physical (i.e., Ethernet) addresses and logical IP addresses. Proxy ARP makes use of this mapping feature by instructing a router to answer ARP requests as a “proxy” for the IP addresses behind one of its ports. The device which sent the ARP request will then correctly assume that it can reach the requested IP address by sending packets to the physical address that was returned to it. This technique effectively hides the fact that a network has been (further) subnetted. If this option is set to **Yes** (def), when an ARP request is received on the Ethernet port the address is looked up in the IP routing table. If the forwarding port is not on the Ethernet port and the route is not the default route, the Express L768/L1.5 will answer the request with its own hardware address. If set to **No**, the Express L768/L1.5 will only respond to ARP requests received for its own IP address.

Configuration/IPX

The IPX menu is used to set up the IPX parameters for the Express L768/L1.5. Any general IPX-related configuration item can be found under this menu. Figure 3-5 shows the IPX menu.

```

Express L1.5/Configuration/IPX
System Info Mode On
WAN Network 00:00:00:00
IP Frame Type Ether Type II
IPX Seed Status Non-Seed
Bridge RIP Timer (10-180) 60
Security SAP Timer (10-180) 60
Frame Relay
PPP Profile
Management

MODE: IP IPX Bridge LOOP: Link down RATE: Idle
^Z=help 11:33_

```

Figure 3-5
Configuration/IPX Screen

IPX/Mode

Write security: 2; Read security: 5

When this option is set to **On** (def), the Express L768/L1.5 will route IPX. Setting it to **Off** will disable all IPX functionality.

IPX/Network

Write security: 2; Read security: 5

The IPX network address for the Ethernet port is set here. This is an eight-digit hexadecimal value that uniquely identifies the network segment of the Ethernet port. Accidental selection of an IPX network which is already in use on another network segment may cause hard-to-diagnose problems. IPX network numbers should be carefully tracked.

IPX/Frame Type

Write security: 2; Read security: 5

The Express L768/L1.5 supports all four defined IPX frame types. The possible frame types are: **Ether Type II** (def), **Ether 802.3 (Raw)**, **Ether 802.2**, or **Ether SNAP** (802.2 SNAP). Only one frame type can be used at one time.

IPX/Seed Status

Write security: 2; Read security: 5

The seed status defines what the Express L768/L1.5 is to do with the network information on the selected frame type during startup. There are three possible seeding selections specified:

Seed - The Express L768/L1.5 will listen for an IPX network number being sent by another router (including Novell software routers residing on servers) on the Ethernet segment connected to this port and use this number if it exists. If it does not discover a number in use, the Express L768/L1.5 will use the configured IPX network number for the Ethernet segment.

Non-Seed (def) - The Express L768/L1.5 will listen for an IPX network number being sent by another router (including Novell software routers residing on servers) on the Ethernet segment connected to this port and use this number if it exists. If it does not discover a number in use, the Express L768/L1.5 will wait indefinitely until a number is sent by another router on the Ethernet segment.

Auto-Seed - The Express L768/L1.5 will listen for an IPX network number being sent by another router (including Novell software routers residing on servers) on the Ethernet segment connected to this port and use this number if it exists. If it does not discover a number in use, the Express L768/L1.5 will auto-generate a valid number using its routing tables.

IPX/RIP Timer

Write security: 3; Read security: 5

This value specifies how often the Express L768/L1.5 sends out IPX RIP packets on the network segment attached to the Ethernet port. The RIP packets sent contain routing information about the networks for which this Express L768/L1.5 is responsible. The default value is 60 seconds.

IPX/SAP Timer

Write security: 3; Read security: 5

This value specifies how often the Express L768/L1.5 sends out IPX SAP (Service Access Protocol) packets on the network segment attached to the Ethernet port. The SAP packets sent contain information about the services (such as servers, printers, etc.) for which this Express L768/L1.5 is responsible. The default value is 60 seconds.

Configuration/Bridge

The Bridge menu is used to set up the bridge parameters for the Express L768/L1.5. The bridging function runs at the Media Access Control (MAC) level which allows any protocol packets that run over Ethernet to be forwarded. Bridging can run concurrently with the IP and IPX routing. However, certain rules apply for when packets are bridged across a WAN connection. When IP routing is active, IP packets (which include ARP packets) are not bridged. When IPX routing is active, IPX packets are not bridged. Also, the WAN IP Bridge and WAN IPX Bridge menus allow the WAN connection to bridge packets to the Express L768/L1.5 but get routed as soon as they arrive at the unit. Figure 3-6 shows the Bridge menu.

```

Express L1.5/Configuration/Bridge
System Info Mode On
WAN WAN IP Bridge [+]
IP WAN IPX Bridge [+]
IPX Spanning Tree [+]
Bridge Address Table [+]
Security
Frame Relay
PPP Profile
Management

MODE: IP IPX Bridge LOOP: Link down RATE: Idle
~Z=heIp 11:34

```

Figure 3-6
Configuration/Bridge Screen

Bridge/Mode

Write security: 2; Read security: 5

When this option is set to **On** (def), the Express L768/L1.5 bridge function will be enabled. Setting it to **Off** will disable all bridge functionality.

Bridge/WAN IP Bridge

When IP routing is active, the Express L768/L1.5 will allow another WAN device to bridge IP packets to it using PPP BCP. Normally, two IP routers would

negotiate PPP IPCP to exchange IP packets. However, if a device can only support PPP BCP, IP packets are encapsulated by the device as bridge packets. The Express L768/L1.5 can treat the WAN IP Bridge as a virtual Ethernet port connected only to a WAN device which has negotiated PPP BCP. This menu allows the IP parameters for this virtual Ethernet to be set up.

WAN IP Bridge/Network

Write security: 2; Read security: 5
This is the IP address of the virtual Ethernet port.

WAN IP Bridge/Netmask

Write security: 2; Read security: 5
This is the network mask to be applied to the virtual Ethernet port.

WAN IP Bridge/Triggered

Write security: 2; Read security: 5
When set to **Yes**, only IP RIP updates are sent when the routing table has changed. When set to **No** (def), updates are sent periodically.



RIP version, method, and direction are determined by the Ethernet parameters set in the Configuration/IP/IP Router/RIP menu.

WAN IP Bridge/Proxy ARP

If this option is set to **Yes** (def), the Express L768/L1.5 will proxy ARP on the bridge IP port. See the section *IP/Proxy ARP* on page 32 for an explanation of the proxy ARP function.

Bridge/WAN IPX Bridge

When IPX routing is active, the Express L768/L1.5 will allow another WAN device to bridge IPX packets to it using PPP BCP. Normally, two IPX routers would negotiate PPP IPXCP to exchange IPX packets. However, if a device can only support PPP BCP, IPX packets are encapsulated by the device as bridge packets. The Express L768/L1.5 can treat the WAN IPX Bridge as a virtual Ethernet port connected only to a WAN device which has negotiated PPP BCP. This menu allows the IPX parameters for this virtual Ethernet to be set up.

WAN IPX Bridge/Network

Write security: 2; Read security: 5

This is the network address of the virtual Ethernet port. See *IPX/Network* on page 33 for an explanation of the IPX network number.

WAN IPX Bridge/Frame Type

Write security: 2; Read security: 5

This is the frame type used for the virtual Ethernet port. See *IPX/Frame Type* on page 34 for an explanation of the IPX frame type.

WAN IPX Bridge/Seed Status

Write security: 2; Read security: 5

This is the seed status used for the virtual Ethernet port. See *IPX/Seed Status* on page 34 menu for an explanation of the IPX seed status.

WAN IPX Bridge/Triggered

Write security: 2; Read security: 5

When set to **Yes**, only IPX RIP and SAP updates are sent when the routing or service table has changed. When set to **No** (def), updates are sent periodically.



RIP and SAP periodic rates set for the Ethernet port (see IPX/RIP Timer on page 34 and IPX/SAP Timer on page 35) are used for the WAN IPX bridge port.

Bridge/Spanning Tree

The Spanning Tree Algorithm and Protocol ensures a loop-free topology and provides redundancy. The protocol parameters can be specifically tuned from their defaults, though most applications require no adjustment.

Spanning Tree/Mode

Write security: 2; Read security: 5

When the mode is set to **On**, the Express L768/L1.5 will participate in the Spanning Tree protocol between other bridges. When **Off** (def), all bridge ports remain permanently open for forwarding.

Spanning Tree/Priority

Write security: 2; Read security: 5

This assigns a priority to the Express L768/L1.5 that permits the relative priority of multiple bridges to be managed. The range is 0 to 65535 with a default of 32768.

Spanning Tree/Maximum Age

Write security: 2; Read security: 5

This is the timeout value used by the Express L768/L1.5 to test against the root device. The value is in one-tenth seconds with a range between 60 (6.0 seconds) and 400 (40.0 seconds). The default is 200 (20.0 seconds).

Spanning Tree/Hello Time

Write security: 2; Read security: 5

This is the time between the generation of configuration BPDUs (Bridging Protocol Data Units) by the root bridge. The value is in one-tenth seconds with a range between 10 (1.0 second) and 100 (10.0 seconds). The default is 20 (2.0 seconds).

Spanning Tree/Forward Delay

Write security: 2; Read security: 5

This is the time spent in the listening and learning state while moving from the blocking state to the forwarding state. The value is in one-tenth seconds with a range between 40 (4.0 seconds) and 300 (30.0 seconds). The default is 150 (15.0 seconds).

Spanning Tree/LAN Port

The path cost and priority parameters for the Ethernet port are specified under this menu.

LAN Port/Active

Write security: 2; Read security: 5

The Ethernet port can be disabled when set to **No**. In this mode, no bridge traffic will be forwarded in or out. Setting to **Yes** (def) allows the port to participate in the spanning tree topology.

LAN Port/Path Cost

Write security: 2; Read security: 5

This is the cost of using the Ethernet port in the total cost of the path. The range is from 1 to 65535 with a default of 100 (for 10 Mbits/second).

LAN Port/Priority

Write security: 2; Read security: 5

The priority adjusts the relative priority of the Ethernet port among the multiple bridge ports. The range is 0 to 255 with a default of 128.

Spanning Tree/Bridge Group 1

The Bridge Group 1 is either the first PPP BCP connection or part of multiple DLCI destinations when running Bridge (RFC 1490) over Frame Relay.

Bridge Group 1/Active

Write security: 2; Read security: 5

The Bridge Group 1 port can be disabled when set to **No**. In this mode, no bridge traffic will be forwarded in or out. Setting to **Yes** (def) allows the port to participate in the Spanning Tree topology.

Bridge Group 1/Path Cost

Write security: 2; Read security: 5

This is the cost of using the Bridge Group 1 in the total cost of the path. The range is from 1 to 65535 with a default of 1302 (for 768 kbits/second).

Bridge Group 1/Priority

Write security: 2; Read security: 5

The priority adjusts the relative priority of the Bridge Group 1 among the multiple bridge ports. The range is 0 to 255 with a default of 128.

Spanning Tree/Bridge Group 2

Bridge Group 2 is part of multiple DLCI destinations when running Bridge (RFC 1490) over Frame Relay.

Bridge Group 2/Active

Write security: 2; Read security: 5

This setup is exactly like Bridge Group 1 above.

Bridge Group 2/Path Cost

Write security: 2; Read security: 5

This setup is exactly like Bridge Group 1 above.

Bridge Group 1/Priority

Write security: 2; Read security: 5

This setup is exactly like Bridge Group 1 above.

Bridge/Address Table

The Express L768/L1.5 automatically maintains a table of MAC addresses detected and associates those addresses with the LAN, WAN0, or WAN1 port from which they were received. WAN 0 represents Bridge Group 1, and WAN1 represents Bridge Group 2. This menu permits the user to adjust the parameters or rules for the table as addresses are learned.

Address Table/Aging

Write security: 3; Read security: 5

This is the maximum time an idle MAC address remains in the table before being removed. The value is in minutes and can range from 0 (which means never age) to 65535. The default is 5.

Address Table/Forward Policy

Write security: 3; Read security: 5

When this parameter is set to **Unknown** (def), any bridge packet with a destination MAC address that is not in the bridge table is forwarded to all other ports. When set to **Known**, the packet with the unknown destination MAC address is dropped and is not forwarded.

Configuration/Security

The Security menu is used to set up the authentication parameters needed to authenticate PPP connection. Also, the filter defines are placed under this menu. Figure 3-7 shows the Security menu.

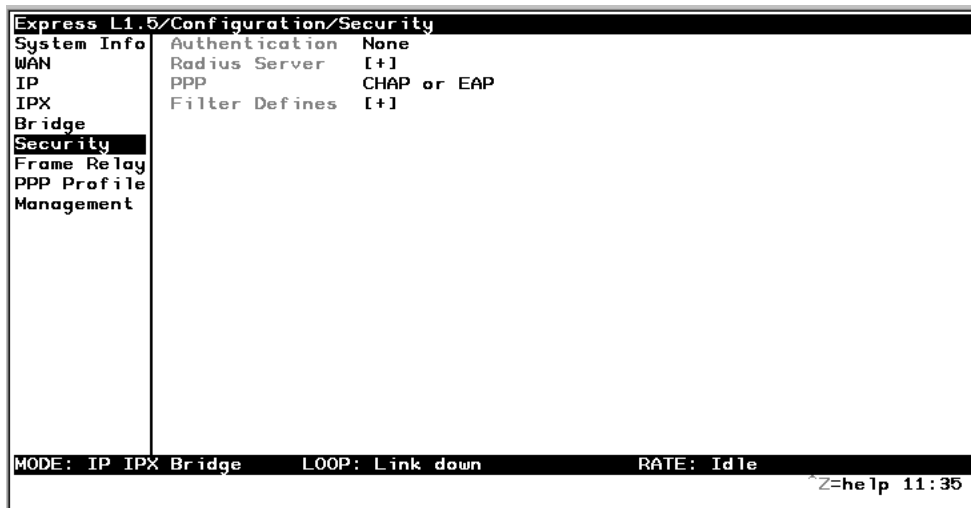

Figure 3-7
Configuration/Security Screen

Security/Authentication

Write security: 1; Read security: 2

The method used for authenticating the PPP peer is selected here. The possible values are:

None (def) - No attempt is made to authenticate the PPP peer.

Radius - The Express L768/L1.5 will act as a RADIUS client and authenticate the PPP peer using the RADIUS server. The Radius server parameters must be set up properly for this to work.

PPP Profile - The PPP profile is used to authenticate the PPP peer.

See *Configuration/PPP Profile* on page 56 for more information on authenticating.

Security/Radius Server

The parameters for the radius server are configured in this menu. The RADIUS server can be used for authenticating a PPP peer (if defined under **Security/Authentication**) and for Telnet server sessions.

Radius Server/Primary Server

Write security: 1; Read security: 2

This is the IP address of the first RADIUS server that the Express L768/L1.5 should attempt to communicate with when authenticating a PPP peer.

Radius Server/Secondary Server

Write security: 1; Read security: 2

This is the IP address of the back-up RADIUS server that the Express L768/L1.5 should attempt to communicate with when the primary server does not respond.

Radius Server/UDP Port

Write security: 1; Read security: 2

This is the UDP port that the Express L768/L1.5 should use when communicating with the RADIUS server. The default is 1645, which is the commonly used port.

Radius Server/Secret

Write security: 0; Read security: 1

The RADIUS server and Express L768/L1.5 share this text string, which is used by the RADIUS server to authenticate the Express L768/L1.5 that is the RADIUS client. The factory default is not to use a secret.

Radius Server/Retry Count

Write security: 1; Read security: 2

This is the number of times the Express L768/L1.5 should send a request packet to the RADIUS server without a response before giving up. If the number of attempts to communicate with the primary server is equal to the retry count, the secondary server (if defined) is tried. If the secondary server does not

respond within the retry count, the PPP peer (or Telnet session) is not authenticated and is dropped. The default is 5.

Security/PPP

Write security: 1; Read security: 2

The PPP peer can be authenticated using three standard methods: PAP (Password Authentication Protocol), CHAP (Challenge Handshake Protocol) and EAP (Extensible Authentication Protocol). The strength of the authentication is determined in the order EAP, CHAP, followed by PAP, where EAP is the strongest and PAP is the weakest. PAP is a clear-text protocol, which means it is sent over the PPP link in a readable format. Care must be taken not to allow highly sensitive passwords to become compromised using this method. CHAP and EAP use a one-way hashing algorithm which makes it virtually impossible to determine the password. EAP has other capabilities which allow more flexibility than CHAP.

The following selections are possible:

PAP, CHAP or EAP (def) - The Express L768/L1.5 will ask for EAP during the first PPP LCP negotiation and allow the PPP peer to negotiate down to CHAP or PAP.

CHAP or EAP - The Express L768/L1.5 will ask for EAP during the first PPP LCP negotiation and allow the PPP peer to negotiate down to CHAP but not PAP.

EAP - The Express L768/L1.5 will only allow EAP to be negotiated. If the PPP peer is not capable of doing EAP, then the connection will not succeed.

Security/Filter Defines

The Express L768/L1.5 can filter packets based on certain parameters within the packet. The method used by the Express L768/L1.5 allows the highest flexibility for defining filters and assigning them to a profile. The filters are set up in two steps: (1) defining the packet types, and (2) adding them to a list under the PPP profile or DLCI map. See the section *DLCI Mapping/Filters* on page 54 for examples of how to set up filter profiles. This menu is used to define the individual filter defines based on packet type.

Filter Defines /MAC Filter Defines

Write security: 2; Read security: 3

The MAC filter is applied to bridge packets only. Bridge packets which are forwarded by the bridge functionality of the Express L768/L1.5 are defined here.

Up to 32 MAC defines can be specified.

Name	Identifies the filter entry
Src Addr	48-bit MAC source address used for comparison. (hexadecimal format)
Src Mask	Bits in the MAC source address which are compared. (hexadecimal format)
Dest Addr	48-bit MAC destination address used for comparison. (hexadecimal format)
Dest Mask	Bits in the MAC destination address used for comparison. (hexadecimal format)
MAC Type	16-bit MAC type field used for comparison. (hexadecimal format)
Type Msk	Bits in the MAC type field used for comparison. (hexadecimal format)

Filter Defines /Pattern Filter Defines

Write security: 2; Read security: 3

The pattern filter is applied to bridge packets only. That is any packet which is forwarded by the bridge functionality of the Express L768/L1.5. Up to 32 pattern defines can be specified.

Name	Identifies the filter entry
Offset	Offset from beginning of packet of where to start the pattern comparison
Pattern	64 bits used for comparison. (hexadecimal format)
Mask	Bits in the pattern to be compared. (hexadecimal format)

Filter Defines /IP Filter Defines

Write security: 2; Read security: 3

The IP filter defines apply to any IP packet, whether it is routed or bridged. Up to 32 IP defines can be specified.

Name	Identifies the filter entry
IP Src	IP address compared to the source address. (dotted decimal format)
Src Mask	Bits which are used in the source comparison. (dotted decimal format)
IP Dest	IP address compared to the destination address. (dotted decimal format)
Dest Mask	Bits which are used in the destination comparison. (dotted decimal format)
Src Port	IP source port number used for comparison Range: 0 to 65535. (decimal format)
Src Port Cmpr	Type of comparison that is performed = - means ports equal to not = - means port not equal to > - means port greater than < - means port less than None - means the source port is not compared
Dst Port	IP destination port number used for comparison Range: 0 to 65535. (decimal format)
Dst Port Cmpr	Type of comparison that is performed = - means ports equal to not = - means port not equal to > - means port greater than < - means port less than None - means the destination port is not compared
Proto	Protocol used for comparison. Range: 0 to 255. (decimal format)
Proto Cmpr	Type of comparison that is performed = - means protocols equal to not = - means protocols not equal to > - means protocols greater than < - means protocols less than None - means the protocol is not compared
TCP Est	Yes - only when TCP established No - only when TCP not established Ignore - ignore TCP flags

Filter Defines /IPX Filter Defines

Write security: 2; Read security: 3

The IPX filter defines apply to any IPX packet whether it is routed or bridged. Also, any IPX encapsulation type will be accounted for. Up to 32 IPX defines can be specified.

Name	Identifies the filter entry (15 characters max)
Src Net	32-bit source network address
Src Mask	Bits in the source network address which are compared. (hexadecimal format)
Dest Net	32-bit destination network address
Dest Mask	Bits in the destination network address which are compared. (hexadecimal format)
Src Socket	16-bit value which is the source socket. Range: 0-65535.
Src Socket Comp	Type of comparison that is performed: = - means socket equal to Not = - means socket not equal to > - means socket greater than < - means socket less than None - no comparison is done on source socket
Dest Socket	16-bit value which is the destination socket. Range: 0-65535.
Dest Socket Comp	Type of comparison that is performed: = - means socket equal to Not = - means socket not equal to > - means socket greater than < - means socket less than None - no comparison is done on destination socket
Type	8-bit value which is the IPX type
Type Comp	Type of comparison that is performed: = - means type equal to Not = - means type not equal to > - means type greater than < - means type less than None - no comparison is done on IPX type

Configuration/Frame Relay

Frame Relay is a connection-oriented service requiring circuits to be configured by your carrier to establish a physical link between two or more locations. Multiple virtual circuits (which appear as virtual point-to-point links) can be run through the same physical connection.

There are two types of virtual circuits supported in Frame Relay: Permanent Virtual Circuits (PVC) and Switched Virtual Circuit (SVC). PVCs are like dedicated point-to-point private lines. Since the physical connection is always there in the form of a leased line, call setup and tear down is done by a carrier via a network management system. SVCs require setup and tear down and are generally not available from Frame Relay carriers. Virtually all Frame Relay communications is done using PVCs. The Express L768/L1.5 supports PVCs only.

A number called the Data Link Connection Identifier (DLCI) identifies each virtual circuit within a shared physical channel.

Figure 3-8 shows the Frame Relay menu.

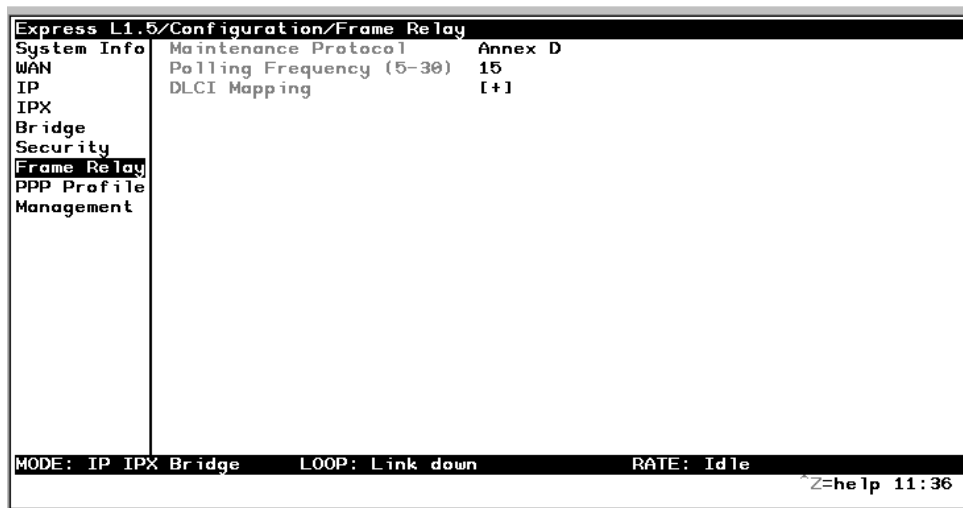

Figure 3-8
Configuration/Frame Relay Screen

Frame Relay/Maintenance Protocol

Write security: 3, Read security: 5

The Frame Relay maintenance protocol is used on the WAN port. The maintenance protocol is used to send link status and virtual circuit information between Frame Relay switches and other devices (such as routers) that communicate with them. Possible choices are listed below.

Annex D (def) - This is an ANSI standard and is the most commonly used standard in the US.

Annex A - This is the CCITT European standard.

LMI - This was developed by a vendor consortium and is also known as the “consortium” management interface specification. It is still used by some carriers in the U.S.

Static - This should be selected when there is no Frame Relay switch in the circuit. The DLCIs are assigned in the DLCI Mapping and must be the same for the device it will communicate with.

Frame Relay/Polling Frequency

Write security: 3, Read security: 5

This parameter is the interval that the Express L768/L1.5 polls the Frame Relay switch using the maintenance protocol selected above. The Express L768/L1.5 is required to poll the Frame Relay switch periodically to determine whether the link is active. The value is in seconds and ranges from 5 to 30 seconds with a default of 15 seconds.

Frame Relay/DLCI Mapping

This menu allows each DLCI to be mapped to a particular Frame Relay maintenance protocol. Each protocol parameter can be individually configured for each DLCI. By factory default, the DLCI map is empty.

When empty and a maintenance protocol other than static is used, the Express L768/L1.5 will poll the switch to determine which DLCIs are active. These active DLCIs will attempt to determine the IP and IPX addresses on the other end of the virtual circuit using Inverse ARP (IARP). If there is a response, the network learned will be added to the router tables and the virtual circuit will be treated as an unnumbered interface. Bridge mode is not attempted in this case.

When more than one DLCI mapping is listed, the Express L768/L1.5 will try to match the DLCIs learned from the Frame Relay switch with the DLCI values in the map. If there is a match, the protocols specified in the map are used. However, if an active DLCI is not in the list it looks for an entry that has 0 in the DLCI field. This entry is considered the default entry to use when no match occurs. If this default entry is not present, the Express L768/L1.5 falls back to using IARP as in the previous paragraph to determine the protocols to use with that particular virtual circuit. If a static maintenance protocol is used, at least one DLCI mapping must be specified.



NOTE

To insert a new profile, press the **I** key when over the **Num** column. A new inserted profile will always be set up with the default parameters. To copy parameters from an old profile to this newly inserted profile, use the copy (**C**) and paste (**P**) keys. Entire configuration trees can be copied with this method.



NOTE

To delete an unused profile, use the **D** key when the cursor is over the number in the **Num** column. Once deleted, the profile is gone permanently as soon as the DLCI Mapping is saved. Items may be deleted when **DEL** appears below the status bar.

DLCI Mapping/Active

Write security: 3, Read security: 5

When this parameter is set to **Yes** (def), the mapping is used to determine the protocols used. If set to **No**, the Express L768/L1.5 will ignore the virtual circuit with this DLCI.

DLCI Mapping/DLCI

Write security: 3, Read security: 5

This is the DLCI associated with this virtual circuit. This value can range from 16 to 1007.

DLCI Mapping/IP Map

Write security: 3, Read security: 5

This menu represents the IP protocol mapping that is to take place for this DLCI.

IP Map/Active

Write security: 3, Read security: 5

When this is set to **Yes** (def), the Express L768/L1.5 will attempt to transport IP packets for this DLCI. A setting of **No** means that no IP traffic or route will be exchanged.

IP Map/IARP

Write security: 3, Read security: 5

When this is set to **Yes** (def), the Express L768/L1.5 will send Inverse ARP packets in order to determine the IP address on the other end of the virtual circuit. If the IARP is responded to, a route is placed in the IP route table. A setting of **No** means that the route address is to be assigned statically using the **IP Map/Far-End IP Address** parameter. The Express L768/L1.5 will always respond to Inverse ARP requests.

IP Map/Far-End IP Address

Write security: 3, Read security: 5

This is the IP address of the device on the other end of the virtual circuit. When this DLCI becomes active, the Express L768/L1.5 will add a route in the IP routing table.

IP Map/IP Netmask

Write security: 3, Read security: 5

The IP network mask to apply to the **Far-End IP Address** and **Link IP Address** is specified here.

IP Map/Link IP Address

Write security: 3, Read security: 5

The virtual circuit may require an IP address to be specified at this DLCI interface. This is called a numbered interface. This address is used by the Express L768/L1.5 to respond to Inverse ARP requests. If this IP address is left as 0.0.0.0, the link is treated as unnumbered and the Express L768/L1.5 responds to the Inverse ARP with its Ethernet IP address.

IP Map/RIP Protocol

Write security: 3, Read security: 5

The RIP protocol can be specified per DLCI. The possible selections are **Off** (meaning no RIP packets are listened to or sent), **V1** (def) (which is RIP version 1) or **V2** (which is RIP version 2).

IP Map/RIP Method

Write security: 3, Read security: 5

The way the RIP protocol sends out its advertisements is specified here:

None - All routes in the router table are advertised out this virtual circuit with no modification of the metrics.

Split Horizon (def) - Only routes not learned from this particular virtual circuit are advertised.

Poison Reverse - All routes are advertised, but the routes learned from this port are “poisoned” with an infinite metric.

IP Map/RIP Direction

Write security: 3, Read security: 5

This parameter allows the direction at which RIP advertisements are sent and listened to be specified.

Tx and Rx (def) - RIP advertisements are periodically transmitted and are listened to on this virtual circuit.

Tx Only - RIP advertisements are periodically transmitted but are not listened to on this virtual circuit.

Rx Only - RIP is not transmitted on this virtual circuit but they are listened to.

IP Map/NAT

The Express L768/L1.5 can perform Network Address Translation over a PVC. Setting this option to **On** will cause the Express L768/L1.5 to translate between the Ethernet addresses and the configured **Link IP Address**. Only one PVC may be used for translation at one time. If more than one IP Map is configured for NAT, the first PVC which is activated becomes the NAT port.

DLCI Mapping/IPX Map

This menu represents the IPX protocol mapping that is to take place for this DLCI.

IPX Map/Active

Write security: 3, Read security: 5

When this is set to **Yes** (def), the Express L768/L1.5 will attempt to transport IPX packets for this DLCI. A setting of **No** means that no IPX traffic or route will be exchanged.

IPX Map/IARP

Write security: 3, Read security: 5

When this is set to **Yes** (def), the Express L768/L1.5 will send Inverse ARP packets to determine the IPX network on the other end of the virtual circuit. If the IARP is responded to, a route is placed in the IPX route table. A setting of **No** means that the IPX network is to be assigned to the link statically using the IPX Map/Link Network parameter. The Express L768/L1.5 will always respond to Inverse ARP requests.

IPX Map/Link Network

Write security: 3, Read security: 5

This is the IPX network of the link or of the other device's LAN. When this DLCI becomes active, the Express L768/L1.5 will add a route to this network in the IPX routing table. This address is also used by the Express L768/L1.5 to respond to Inverse ARP requests. If this IPX address is left as 0, the link is treated as unnumbered and the Express L768/L1.5 responds to the Inverse ARP with its Ethernet IPX address.

DLCI Mapping/Bridge Map

This menu is used to permit bridging of packets over this DLCI. Each DLCI or virtual circuit must be assigned a bridge group. The bridge group treats all virtual circuits as one circuit. Bridge packets destined to be transmitted out a particular bridge group are copied and transmitted individually out each DLCI in the bridge group. However, incoming bridge packets received from one DLCI are not retransmitted out the other DLCIs in the same bridge group. Any device in the bridge group must transmit to each DLCI. This requires a fully meshed circuit, meaning each device has a virtual circuit to each other.

Bridge Map/Active

Write security: 3, Read security: 5

When this is set to **Yes** (def), the Express L768/L1.5 will bridge packets to and from this DLCI. Bridge packets are any packets that are not IP or IPX packets except when the router is turned off, in which case that particular router's protocol packets are bridged. A setting of **No** means that no bridging will occur.

Bridge Map/Bridge Group

Write security: 3, Read security: 5

The bridge group that this DLCI is part of is specified here as **Group 1** or **Group 2**. These groups correspond to the spanning tree protocols Bridge Group 1 and Bridge Group 2.

DLCI Mapping/Filters

The Express L768/L1.5 can block packets in and out of a PVC port by use of the filters. They are set up in two steps: 1) define the types of packets that would be of interest in the **Configuration/Security/Filter Defines** menu, and 2) set up the filter type and combination of defines that will cause a packet block.

Filters/In from PVC

Write security: 2; Read security: 5

The packets which come into the Express L768/L1.5 via this PVC can be filtered in three ways:

Disabled (def) - Turns off packet input filtering. No incoming packets from this PVC are blocked.

Block All - All incoming packets from this PVC are blocked except as defined in the **Filters/In Exceptions** list.

Forward All - All incoming packets from this PVC are not blocked except as defined in the **Filters/In Exceptions** list.

Filters/In Exceptions

Write security: 2; Read security: 5

This is a list of up to 32 filter entries which can be combined using the operations field. The operations are performed in the order they appear on the list.

Active - Turns this entry active when set to **On**.

Type - Selects the filter define list to reference:

- MAC** - from the **Configuration/Security/Filter Defines/MAC Filter Defines** list.
- Pattern** - from the **Configuration/Security/Filter Defines/Pattern Filter Defines** list.
- IP** - from the **Configuration/Security/Filter Defines/IP Filter Defines** list.
- IPX** - from the **Configuration/Security/Filter Defines/IPX Filter Defines** list.

Filter List Name - Selects between filters defined in the list.

Next Oper - The next operation to use to combine with the next filter in the list:

- END** - the last filter to combination.
- AND** - logically AND this filter with the next filter in the list.
- OR** - logically OR this filter with the next filter in the list.

Filters/Out to PVC

Write security: 2; Read security: 5

The packets which transmit out this PVC from the Express L768/L1.5 can be filtered in three ways:

Disabled (def) - Turns off packet output filtering. No outgoing packets to this PVC are blocked.

Block All - All outgoing packets to this PVC are blocked except as defined in the **Filters/Out Exceptions** list.

Forward All - All outgoing packets to this PVC are not blocked except as defined in the **Filters/Out Exceptions** list.

Filters/Out Exceptions

Write security: 2; Read security: 5

This is a list of up to 32 filter entries. The setup is exactly the same as the **Filter/In Exceptions** list.

Configuration/PPP Profile

The Express L768/L1.5 uses the PPP profile to specify the profile used when connected using PPP.

Figure 3-9 shows the PPP profile menu.

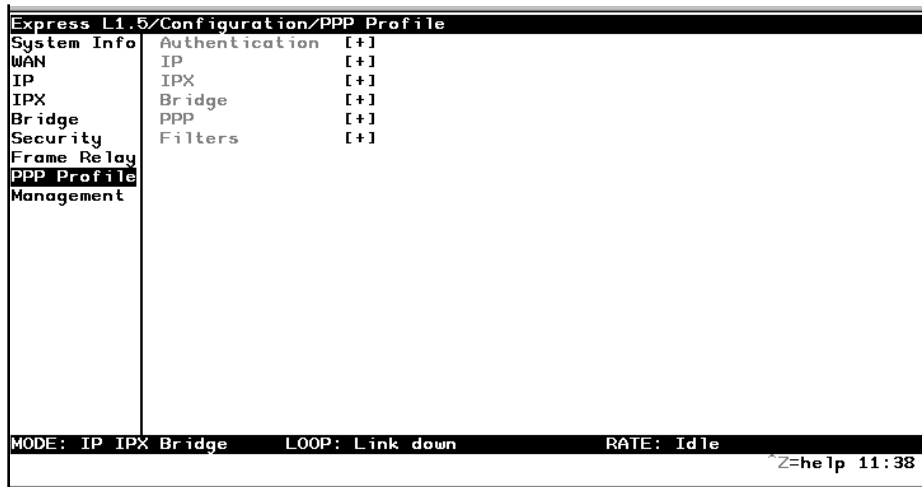

Figure 3-9
Configuration/PPP Profile Screen

PPP Profile/Authentication

The authentication menu contains the required parameters for the authentication of the PPP peer and for being authenticated by the PPP peer.

Authentication is applied between the Express L768/L1.5 and the PPP peer as follows:

Authentication/Tx Method

Write security: 2; Read security: 3

This parameter specifies how the Express L768/L1.5 is to be authenticated by the PPP peer. There are four possible selections. See *Security/PPP* on page 44 for an explanation of the three PPP standard authentication types.

None (def) - The connection will not allow the PPP peer to authenticate it.

PAP, CHAP or EAP - The connection can be authenticated using PAP, CHAP or EAP.

CHAP or EAP - The connection can be authenticated using CHAP or EAP only.

EAP - The connection will only allow authentication by the peer using EAP.

Authentication/Tx Username

Write security: 1; Read security: 3

This is the username that is used when being authenticated by the PPP peer.

Authentication/Tx Password

Write security: 0; Read security: 1

This is the password or secret that is used when being authenticated by the PPP peer.

Authentication/Rx Username

Write security: 1; Read security: 3

This is the username used to authenticate the PPP peer.

Authentication/Rx Password

Write security: 0; Read security: 1

This is the password or secret that is used to authenticate the PPP peer.

PPP Profile/IP

The IP menu contains the parameters for exchanging IP data with the PPP peer.

IP/Mode

Write security: 3; Read security: 5

Setting to **On** (def) will permit this connection profile to negotiate PPP IPCP with the PPP peer for exchanging of IP packets.

IP/NAT

Write security: 3; Read security: 5

The Express L768/L1.5 can perform Network Address Translation. This feature is most widely used when connecting to the Internet. The Ethernet network can consist of private network numbers. When this profile is connected, all IP addresses on the Ethernet side are translated into the one real IP address negotiated with the PPP peer (ISP). Multiple stations on the Ethernet side can access the Internet simultaneously. See the section *IP/NAT* on page 29 for more global options. Setting this option to **On** will cause the Express L768/L1.5 to perform NAT. In the **Off** (def) position, the unit will route across the connection normally.

IP/Route

The IP parameters are configured in this menu. Usually the Express L768/L1.5 will automatically discover the PPP peer's networks using PPP IPCP and/or RIP.

Route/IP/Net

Write security: 3; Read security: 5

The PPP peer's IP address or network can be set here, if known. Leaving this at 0.0.0.0 means that the Express L768/L1.5 will determine the PPP peer's IP and network using the PPP IPCP.

Route/Netmask

Write security: 3; Read security: 5

This network mask is applied to the **IP/NET** address for determining the PPP peer's network. If left as 0.0.0.0, a standard network mask is used.

Route/Force IP

Write security: 3; Read security: 5

When set to **Yes**, the Express L768/L1.5 will force the PPP peer to use the IP address in the **IP/Net** for this profile as its WAN IP address. Normally this is set in the **No** (def) position.

IP/RIP

The RIP parameters can be adjusted from their defaults under this menu.

RIP/Mode

Write security: 3; Read security: 5

The Express L768/L1.5 will perform RIP over the WAN connection when this is set to **On** (def).

RIP/Protocol

Write security: 3; Read security: 5

The Express L768/L1.5 can perform version 1, **V1** (def), or version 2, **V2**, of RIP on this WAN connection.

RIP/Method

Write security: 3; Read security: 5

Split Horizon - Only routes not learned on the WAN connection are advertised.

Poison Reverse (def) - All routes are advertised, including routes learned from the WAN connection. These routes are poisoned.

None - All routes are advertised, including routes learned from the WAN connection. No attempt is made to poison these routes.

RIP/Direction

Write security: 3; Read security: 5

Tx and Rx (def)- RIP advertisements are transmitted and listened to on the WAN connection.

Tx only - RIP advertisements are transmitted and not listened to.

Rx only - RIP advertisements are listened to but not transmitted.

RIP/Triggered

Write security: 3; Read security: 5

When set to **Yes**, only IP RIP updates are sent when the routing table has changed and learned routes are not “aged.” When set to **No** (def), updates are sent periodically.

PPP Profile/IPX

The IPX menu contains the parameters for exchanging IPX data with the PPP peer.

IPX/Mode

Write security: 3; Read security: 5

Setting to **On** (def) will permit this connection profile to negotiate PPP IPXCP with the PPP peer for exchanging of IPX packets.

IPX/Remote Network

Write security: 3; Read security: 5

A non-zero value in this remote network number will allow the Express L768/L1.5 to add a route to the PPP peer’s network to the routing table.

The Express L768/L1.5 normally will treat the WAN network as an unnumbered link. This is usually referred to as being a “half-router.” However, a PPP peer which wants to assign a network address to the WAN link can do so, in which case the Express L768/L1.5 will go into “full-router” mode.

IPX/Triggered

Write security: 3; Read security: 5

When set to **Yes**, only IPX RIP and SAP updates are sent when the routing or service table has changed and learned routes are not “aged.” When set to **No** (def), updates are sent periodically based on the RIP and SAP timers set in **Configuration/IPX/RIP Timer** and **Configuration/IPX/SAP Timer**.

IPX/Type 20 Packets

Write security: 3; Read security: 5

In order for certain protocol implementations, like NetBIOS, to function in the NetWare environment, routes must allow a broadcast packet to be propagated throughout the IPX networks. The Type 20 IPX packet is used specifically for

this purpose. This causes special handling of this packet by the Express L768/L1.5. When a router receives this type of packet, it rebroadcasts it across all interfaces except the one it is received on and includes the network number of that interface in the data portion of the packet. The IPX Router Specification from Novell notes that Type 20 packets should not be propagated across slower links with bandwidths of less than 1Mbps (like ISDN). However, when set to **Pass** (def), the Express L768/L1.5 will allow these packets to propagate over the WAN connection. This facilitates dial-on-demand applications. When set to **Block**, all Type 20 packets are not propagated across the WAN connection.

PPP Profile/Bridge

The Bridge menu contains the parameters needed for exchanging bridged packets with the PPP peer.

Bridge/Mode

Write security: 3; Read security: 5

When set to **On** (def), the Express L768/L1.5 will attempt to negotiate PPP BCP with the PPP peer. Bridging can be used even in route mode only if the PPP peer cannot support certain PPP protocols for that particular routing protocol. See *Bridge/WAN IP Bridge* on page 36 and *Bridge/WAN IPX Bridge* on page 37 for further details.

PPP Profile/PPP

The Express L768/L1.5 supports the IETF standards for the Point-to-Point Protocol. The PPP state machine running in the Express L768/L1.5 can be fine-tuned to support many applications that can be employed. The configurable items under this menu can be changed from their default values for special cases.

PPP/VJ Compression

Write security: 3; Read security: 5

When this item is set to **On**, the Express L768/L1.5 will perform TCP/IP header compression known as Van Jacobson compression to the PPP peer. Normally, this is not necessary over ISDN connections and can be set to **Off** (def) to disable it.

PPP/Max Config

Write security: 3; Read security: 5

This value is the number of unanswered configuration-requests that should be transmitted before giving up on a call. The possible values are 5, 10 (def), 15 and 20.

PPP/Max Timer

Write security: 3; Read security: 5

This value is the number of seconds to wait between unanswered configuration-requests. The possible values are 1 sec, 2 secs (def), 3 secs, 5 secs and 10 secs.

PPP/Max Failure

Write security: 3; Read security: 5

Due to the nature of PPP, configuration options may not be agreed upon between two PPP peers. This value is the number of configuration-naks that should occur before an option is configuration-rejected. This allows a connection to succeed that might otherwise fail. The possible values are 5 (def), 10, 15 and 20.

PPP Profile/Filters

The Express L768/L1.5 can block packets in and out of a WAN port by use of the filters. They are set up in two steps: 1) define the types of packets that would be of interest in the **Configuration/Security/Filter Defines** menu, and 2) set up the filter type and combination of defines that will cause a packet block.

Filters/WAN-to-LAN (In)

Write security: 2; Read security: 5

The packets which come into the Express L768/L1.5 can be filtered in three ways:

Disabled (def) - Turns off packet input filtering. No incoming packets are blocked.

Block All - All incoming packets from the WAN are blocked except as defined in the **Filters/In Exceptions** list.

Forward All - All incoming packets from the WAN are not blocked except as defined in the **Filters/In Exceptions** list.

Filters/In Exceptions

Write security: 2; Read security: 5

This is a list of up to 32 filter entries which can be combined using the operations field. The operations are performed in the order they appear on the list.

Active - Turns this entry active when set to **On**.

Type - Selects the filter define list to reference:

- MAC** - from the **Configuration/Security/Filter Defines/MAC Filter Defines** list.
- Pattern** - from the **Configuration/Security/Filter Defines/Pattern Filter Defines** list.
- IP** - from the **Configuration/Security/Filter Defines/IP Filter Defines** list.
- IPX** - from the **Configuration/Security/Filter Defines/IPX Filter Defines** list.

Filter List Name - Selects between filters defined in the list.

Next Oper - The next operation to use to combine with the next filter in the list:

- END** - the last filter to combination.
- AND** - logically AND this filter with the next filter in the list.
- OR** - logically OR this filter with the next filter in the list.

Filters/LAN-to-WAN (Out)

Write security: 2; Read security: 5

The packets which come out toward the WAN from the Express L768/L1.5 can be filtered in three ways:

Disabled (def) - Turns off packet output filtering. No outgoing packets are blocked.

Block All - All outgoing packets to the WAN are blocked except as defined in the **Filters/Out Exceptions** list.

Forward All - All outgoing packets to the WAN are not blocked except as defined in the **Filters/Out Exceptions** list.

Filters/Out Exceptions

Write security: 2; Read security: 5

This is a list of up to 32 filter entries. The setup is exactly the same as the **Filter/In Exceptions** list.

Configuration/Management

The Express L768/L1.5 can be managed using Telnet, Simple Network Management Protocol (SNMP), or the maintenance port. See *Appendix C* on page 99 for a description of the MIBs supported by the Express L768/L1.5. Each of the three methods can be protected using authentication. Figure 3-10 shows the Configuration/Management menu.



Figure 3-10
Configuration/Management Screen

Management/Telnet

Any Telnet client application can bring up a session to the Express L768/L1.5's Telnet server using the standard Telnet TCP port. Only one session is supported at a time. All sessions require a user name and password.

Telnet/Server Access

Write security: 2; Read security: 5

This option must be set to **On** (def) to access the Express L768/L1.5 via Telnet. Turning it **Off** means that access is denied.

Telnet/User List

Up to four users can be configured for access to the Express L768/L1.5. Each user can be assigned a privilege and time out.

User List/Name

Write security: 1; Read security: 3

A text string of the user name for this session.

User List/Authen Method

Write security: 1; Read security: 3

The user can be authenticated in two ways:

Password - The Password field is used to authenticate the user.

Radius - The Radius client is used for authenticating the user.

User List/Password

Write security: 0; Read security: 3

When the authenticating method is password, this text string is used for the password.

User List/Idle Time

Write security: 1; Read security: 3

When set to non-zero, the session is automatically logged out when no activity occurs for this amount of time. The range is 0 to 255 and is in minutes. The default is 10 minutes, and a setting of 0 will never time-out the session. When a timeout occurs during an edit session, all changes are saved.

User List/Level

Write security: 0; Read security: 1

This is the security level privilege that is assigned for this user. See *Security Levels* on page 21 for an explanation of what those levels imply. Level 0 is the default.

Management/SNMP

The Express L768/L1.5 is an SNMP agent. It can respond to Get-Requests, Set-Requests, and generate traps. These two lists set up the manager, communities, and levels. See *Appendix C* on page 99 for more information on SNMP.

SNMP Access

Write security: 3; Read security: 5

When set to **No**, SNMP access is denied. When set to **On** (def), the Express L768/L1.5 will respond to SNMP managers based on the following lists.

SNMP/Communities

This list is used to set up to eight SNMP communities' names that the Express L768/L1.5 will allow. Factory default sets the community "public" with "Get" privileges.

Communities/Name

Write security: 1; Read security: 3

This is a text string for the community name.

Communities/Privilege

Write security: 1; Read security: 3

The access for this manager can be assigned three levels.

None - No access is allowed for this community or manager.

Get - Manager can only read items.

Get/Set - Manager can read and set items.

Communities/Manager IP

Write security: 1; Read security: 3

This is the IP address of SNMP manager. If set to 0.0.0.0, any SNMP manager can access the Express L768/L1.5 for this community.

SNMP/Traps

The Express L768/L1.5 can generate SNMP traps. See *Appendix C* on page 99 for trap types supported. This list allows up to four managers to be listed to receive traps.

Traps/Manager Name

Write security: 2; Read security: 4

This is the text string describing the name of the entry. It is intended for easy reference and has no bearing on the SNMP trap function.

Traps/Manager IP

Write security: 2; Read security: 4

This is the IP address of the manager that is to receive the traps.

Management/Maint Port

The Express L768/L1.5 has an EIA-232 connector on the back of the unit. The setup for that port is under this menu.

Maint Port/Password Protect

Write security: 0; Read security: 1

When set to **No**, the maintenance port is not password protected. When **On** (def), the Express L768/L1.5 will prompt for a password upon startup.

Maint Port/Password

Write security: 0; Read security: 1

This is the text string that is used for comparison when password protecting the maintenance port. By default, no password is entered.



NOTE

The security level for the maintenance port is always set to 0. This gives full access to all menus.

Maint Port/Baud Rate

Write security: 5; Read security: 5

This is the asynchronous rate that the maintenance port will run. The possible values are 300, 1200, 2400, 4800, 9600 (def), 19200, 38400, 57600, 115200.

Maint Port/Data Bits

Write security: 5; Read security: 5

This is the asynchronous bit rate that the maintenance port will run. The possible values are 7 or 8 (def) bits.

Maint Port/Parity

Write security: 5; Read security: 5

This is the asynchronous parity that the maintenance port will run. The possible values are **None** (def), **Odd**, or **Even**.

Maint Port/Stop Bits

Write security:5; Read security:5

This is the stop bit used for the maintenance port. The possible values are 1 (def), 1.5 or 2.

Configuration/Terminal Mode

This is an activator which places the Express L768/L1.5 terminal session into a command prompt mode. All menu options are accessible during this mode. See *Appendix E* on page 105 for the command structure and command list. Type **exit** to leave the terminal mode and return to the menus.

STATUS MENU

The Express L768/L1.5's Status menu contains comprehensive status and diagnostic information used in verifying configuration and identifying problems. The menus are divided into protocol types and sessions. Figure 3-11 shows the Status menu.

```
Express L1.5/Status
Configuration
Status
Test
Logs
Utilities
Session      [+]
ARP Cache    [+]
Bridge Table [+]
IP Routes    [+]
IPX Routes   [+]
IPX Servers  [+]
WAN Stats    [+]
LAN Stats    [+]
IP Stats     [+]

MODE: IP IPX Bridge   LOOP: Link down   RATE: Idle
^Z=help 18:11_
```

Figure 3-11
Status Screen

Status/Sessions

This menu contains the current status of all sessions and spanning tree ports.

Sessions/PPP Session

Read security: 5

This menu reflects the results of PPP negotiations, user name, time connected, and data rates for the session.

PPP Links - Reflects LCP layer active

BCP - Shows UP if PPP Bridge Control Protocol has negotiated successfully

IPCP - Shows UP if PPP IP Control Protocol has negotiated successfully

IPXCP - Shows UP if PPP IPX Control Protocol has negotiated successfully

Up Time - Displays how long the call has been connected

Tx Pkts - Number of packets transmitted

Rx Pkts - Number of packets received

Tx Bytes - Number of bytes transmitted

Rx Bytes - Number of bytes received

Tx Rate - Current application data transmission rate

Rx Rate - Current application data reception rate

Sessions/DLCI Table

The status of all virtual circuits is displayed here.

DLCI - The DLCI that is associated with this virtual circuit.

State - The state of the virtual circuit:

Inactive - means the circuit exists but has been deactivated by the Frame Relay switch.

Exists - means the circuit exists at this point and should be activated soon.

Active - means the circuit is fully active.

Off - means the circuit has been turned of by the DLCI mapping active selection.

Tx Frames - Number of Frame Relay packets that have been transmitted via this DLCI.

Rx Frames - Number of Frame Relay packets that have been received via this DLCI.

Tx Bytes - Number of Frame Relay bytes that have been transmitted via this DLCI.

Rx Bytes - Number of Frame Relay bytes that have been received via this DLCI.

IP SubIfc - The IP router port assigned for this DLCI. Possible ports are fr0, fr1, ... , fr9. None means that this DLCI not used for routing IP.

IPX SubIfc - The IPX router port assigned for this DLCI. Possible ports are fr0, fr1, ... , fr9. None means that this DLCI not used for routing IPX.

Bridge Group - The bridge group that this DLCI belongs to (Group 1 or Group 2). None means that this DLCI is not used for bridging.

Sessions/Spanning Tree

Read security: 5

When Bridge mode and Spanning Tree mode are active, this reflects the current state of the LAN and WAN ports. The following can appear:

Off - Appears when Spanning Tree mode is disabled

Disabled - Port is not connected (for WAN) or disabled in configuration

Listening - Port is in the listening state

Learning - Port is in the learning state

Forwarding - Port is in the forwarding state with the following possible properties:

root - is the root port

designated - is designated port

Blocking - Port is in the blocked state

Status/ARP Cache

Read security: 5

This lists the contents of the Express L768/L1.5's ARP table. All resolved cache entries time out after 20 minutes. Unresolved entries time out in 3 minutes.

ARP Cache/IP Address - IP address used for resolving MAC address

ARP Cache/MAC Address - Ethernet address resolved
(0=no resolution)

ARP Cache/Time - Minutes since entry was first entered

Status/Bridge Table

Read security: 5

This lists the contents of the Express L768/L1.5's bridge table.

Bridge Cache/MAC Address - Ethernet address for device learned

Bridge Cache/Port - Port device learned from: LAN, WAN0, or WAN1

Bridge Cache/TTL - Seconds until address is removed from table

Status/IP Routes

Read security: 5

This lists the contents of the Express L768/L1.5's IP router table.

IP Routes /IP Address - Network or host destination address

IP Routes /Netmask - Network mask applied to the destination address

IP Routes /Gateway - Host or router to receive this packet

IP Routes /Port - Port gateway is located on:

local - sent directly to the Express L768/L1.5 router

eth0 - Express L768/L1.5's ethernet port

wan0 - Express L768/L1.5's first PPP bundle

fr 0 . . . fr 9 - Express L768/L1.5 is connected up to 10 DLCIs

IP Routes /Use - Number of times the Express L768/L1.5 has referenced the route

IP Routes/Flags - Important tags associated with this route entry

H - route is a host route

G - route is a gateway route

D - route learned dynamically from RIP

I - route learned from an ICMP redirect

P - route is private and is not advertised with RIP

T - route is to a triggered port (updates only when table changes)

IP Routes/Hops - Number of routers that must go through to get to destination. Ranges from 0-15 or 16 for infinite (can't get there from here).

IP Routes/TTL - Seconds until address is removed from table or "zombied." Value of 999 means route is static.

Status/IPX Routes

Read security: 5

This lists the contents of the Express L768/L1.5's IPX router table.

IPX Routes /Network - Network destination address

IPX Routes /Gateway - Node or Ethernet address of gateway to receive this packet

IPX Routes /Port - Port gateway is located on:

local - sent directly to the Express L768/L1.5 router

eth0 - Express L768/L1.5's ethernet port

wan0 - Express L768/L1.5's first PPP bundle

fr 0 . . . fr 9 - Express L768/L1.5 is connected up to 10 DLCIs

IPX Routes /Use - Number of times the Express L768/L1.5 has referenced the route

IPX Routes/Hops - Number of routers that must go through to get to destination. Ranges from 0-15 or 16 for infinite (can't get there from here).

IPX Routes/Ticks - Router determined value for representing time packets take to reach the network destination. One tick is equivalent to one-eighteenth of a second.

IPX Routes/TTL - Seconds until address is removed from table. Value of 999 means route is static.

Status/IPX Servers

Read security: 5

This lists the contents of the Express L768/L1.5's IPX server table.

IPX Servers/Type - The server type

IPX Servers/Name - The server name

IPX Servers/Network - The server network address

IPX Servers /Address - The servers node address

IPX Servers/Socket - The servers socket address

IPX Servers/Hops - Number of routers that must go through to get to server. Ranges from 0-15 or 16 for infinite.

IPX Servers/TTL - Seconds until address is removed from table. Value of 999 means server is static.

Status/WAN Stats

Read security: 5

This menu contains generic WAN statistics on HDLC hardware port.

HDLC Port

Tx Bytes - total number of raw bytes sent out HDLC port 1

Rx Bytes - total number of raw bytes received in HDLC port 1

Rx CRCs - total number of CRC errors detected on HDLC port 1

Clear Counts - When activated, clears all WAN stat counts

Status/LAN Stats

Read security: 5

This menu contains statistics for the Ethernet port.

Tx Packets - Packets transmitted out the Ethernet port

Rx Packets - Packets received from the Ethernet port

Tx Errors - Total transmit errors encountered on Ethernet port

Single Collisions - total single collisions before successful transmission

Multiple Collisions - total multiple collisions before successful transmission

Excessive Collisions - total collisions that resulted in packet being dropped

Deferred Transmissions - total packets deferred due to collisions

Carrier Sense Errors - total carrier sense errors encountered (no link integrity)

Rx Errors - Total packets received in error and dropped

CRCs - total packets detected with CRC errors

Giants - total packets received that were greater than 1518 bytes

Runts - total packets received that were less than 64 bytes

Rx Collisions - total collision occurred during reception

Clear Counts - When activated, clears all LAN Stat counts.

Status/IP Stats

Read security: 5

This menu contains IP statistics that can be useful when diagnosing problems.

All are taken from the SNMP MIB-2 variables.

- TCP failed attempts
- TCP passive connections
- TCP current connections
- TCP segments sent
- TCP segments received
- Total TCP resets
- Active TCP connections
- Total TCP retransmits
- UDP datagrams sent
- No application at dest. port
- UDP datagrams received
- UDP bad packets
- ICMP redirected messages
- ICMP packet errors
- ICMP timeouts received
- ICMP messages sent
- ICMP messages received
- ICMP specif if errors
- IP datagrams reassembled
- IP datagrams sent
- IP datagrams received
- Total forwarded datagrams
- IP reassembly timeout
- Discarded routing entries
- Total IP fragments
- Failed fragments
- IP reassembly failures
- Disassembled fragments
- Errorfree discards
- Routeless discards
- Default TTL
- Bad IP addresses
- Successful fragments
- Bad header packets
- Sent datagrams to upper layers
- Datagrams discarded
- Bad protocol discards

Clear Counts - clears all IP stats

TEST MENU

The Express L768/L1.5's Test menu contains built-in tests that can be used to diagnose problems. Figure 3-12 shows the Test menu screen.

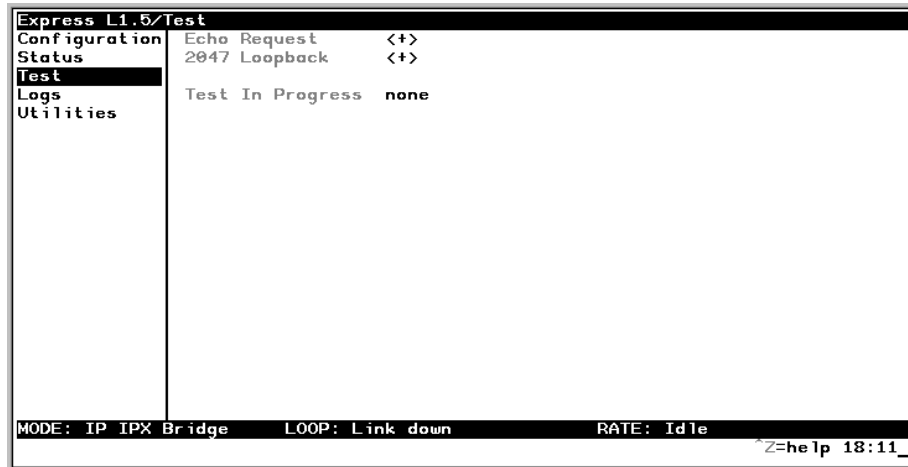

Figure 3-12
Test Screen

The following tests can be run:

Test Menu/Echo Request

Write security: 4, Read security: 5

When activated, the echo request test will begin sending continuous PPP echo request packets to any open LCP ports. Results are displayed on the screen.

This is not used in the Frame Relay mode.

Test Menu/2047 Loopback

Write security: 4, Read security: 5

When activated, a loopback command is sent to the far-end HDSL device and an internal 2047 pattern is continually transmitted towards the HDSL circuit.

Loopbacked data is checked and an error count is maintained.

LOGS MENU

The Logs menu contain logs displaying important information about the running condition of the Express L768/L1.5. The logs can be set to capture diagnostics of error conditions only by way of a log level. The levels are divided up as follows:

- level 0 - Fatal event (causes reset)
- level 1 - Critical event
- level 2 - Error event
- level 3 - Warning event
- level 4 - Notify event
- level 5 - Informational event
- level 6 - Debugging event

Figure 3-13 shows the Logs menu. The three logs available are listed after the figure.



Figure 3-13
Logs Screen

Logs/Sys log Host

Set this to the IP address or domain name (if DNS configured) of the sys log host device. All log events are sent to this device.

Logs/PPP Log

Information pertaining to the PPP negotiation and authentication will be logged here.

PPP Log/Active

When set to **Yes** (def), PPP events below or equal the log level are logged into the log.

PPP Log/Wrap

When set to **Yes** (def), new PPP events will overwrite old PPP events when the log is full. All logging will stop when the log is full and set to **No**.

PPP Log/Level

In order to log events, they must be at or below this level. Range is 0 to 6. The default is 3.

PPP Log/View

This menu displays the log list. The fields are as follows:

Date/Time - Date and time event occurred.

Level - Level associated with this event (0-6).

Message - Text message for this event. If message is too long to fit on the line, another event appears below it continuing the message.

PPP Log/Clear

This clears the log when activated.

Logs/Connection Log

Information pertaining to the connection over the HDSL link.

Connection Log/Active

When set to **Yes** (def), connection events below or equal the log level are logged into the log.

Connection Log/Wrap

When set to **Yes** (def), new connection events will overwrite old connection events when the log is full. All logging will stop when the log is full and set to **No**.

Connection Log/Level

In order to log events, they must be at or below this level. Range is 0 to 6. The default is 3.

Connection Log/View

This menu displays the log list. The fields are as follows:

Date/Time - Date and time event occurred.

Level - Level associated with this event (0-6).

Message - Text message for this event. If message is too long to fit on the line, another event appears below it continuing the message.

Connection Log/Clear

This clears the log when activated.

Logs/Network Log

Information pertaining to the routing protocols is placed in this log.

Network Log/Active

When set to **Yes** (def), call events below or equal the log level are logged into the log.

Network Log/Wrap

When set to **Yes** (def), new Network events will overwrite old Network events when the log is full. All logging will stop when the log is full and set to **No**.

Network Log/Level

In order to log events, they must be at or below this level. Range is 0 to 6. The default is 3.

Network Log/View

This menu displays the log list. The fields are as follows:

Date/Time - Date and time event occurred.

Level - Level associated with this event (0-6).

Message - Text message for this event. If message is too long to fit on the line, another event appears below it continuing the message.

Network Log/Clear

This clears the log when activated.

UTILITIES MENU

The Express L768/L1.5 has utilities embedded in it to help in managing and testing the network and to facilitate software upgrades. Figure 3-14 shows the Utilities menu.

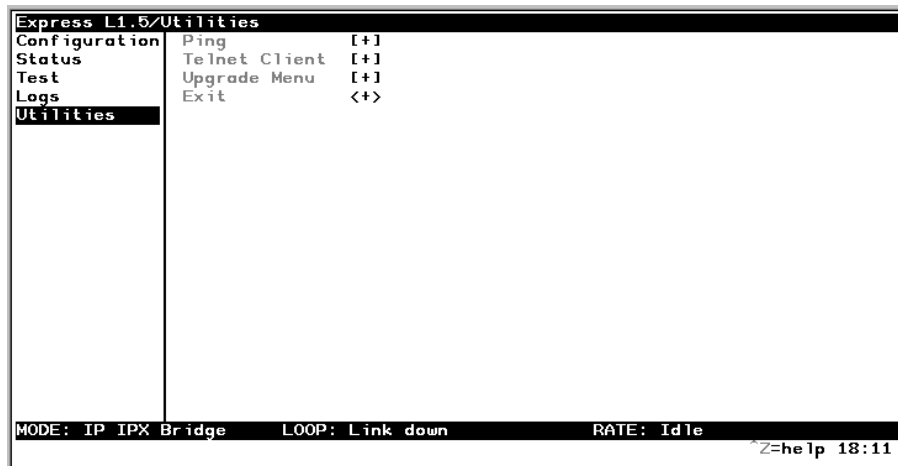

Figure 3-14
Utilities Screen

Utilities/Ping

Write security: 4; Read security: 5

The ping menu is used to send ICMP ping messages to hosts. The following items are under this menu:

Start/Stop - Activator to start and cancel a ping test.

Host Address - IP address or domain name (if DNS is configured) of device to receive the ping

Size - Total size of ping to send. Range is 40 (def) to 1500 bytes.

of Packets - Total packets to send every two seconds

of Transmits - Total packets sent (read only)

of Receives - Total packets received (read only)

% Loss - Percentage loss based on ping returned from host (read only)

Utilities/Telnet Client

Write security: 4; Read security: 5

The Telnet menu can be used to activate the Telnet client function in the Express L768/L1.5.

Host - IP address or domain name (if DNS is configured) of Telnet server. By default, the standard TCP server port is used. However, a nonstandard port can be specified here with the IP address or domain name separated by a colon (:).

Activate - Starts Telnet client function. The key combination **Control]** cancels the session.

Utilities/Upgrade Menu

Write security: 2; Read security: 3

The Express L768/L1.5's firmware can be upgraded using this menu.

Upgrade/Transfer Method

The two methods for upgrading are **TFTP** and **XMODEM**. **TFTP** requires a TFTP server running somewhere on the network. The Express L768/L1.5 starts a TFTP client function which gets the upgrade code from the TFTP server. Selecting **XMODEM** will load the upgrade code through the maintenance port using any PC terminal emulator with xmodem capability.

Upgrade/TFTP Host

This is required when the transfer method is TFTP. It is the IP address or domain name (if DNS is configured) of the TFTP server.

Upgrade/Filename

This is required when the transfer method is TFTP. It is the case-sensitive file name which is the upgrade code.

Upgrade/Status

This appears when TFTP is used. It displays the status of the transfer as it happens. Any error or success message will be displayed here.

Upgrade/Start Transfer

This activator is used when the configurable items in this menu are complete.



*Once started, the Express L768/L1.5 will prompt for erasing the flash. When the flash is erased and the upgrade transfer fails, do not turn off the unit. Retry the transfer until successful. Otherwise, if power is removed before upgrade has finished, the upgrade will have to occur from the maintenance port using XMODEM. If this happens, set a PC terminal emulation program to 9600 baud and attach to the Express L768/L1.5's maintenance port. Press **Return** to display a simple terminal menu for upgrading. This menu appears when the flash code has been erased or is corrupt. The menu will also appear if you power up with the back panel switch one in the up position.*

Upgrade/Abort Transfer

Use this activator to cancel any TFTP transfer in progress.

Upgrade/TFTP Server

Setting this to **Yes** allows another Express L768/L1.5 to upgrade its code using TFTP client. This, in effect, turns on the Express L768/L1.5 TFTP server function and allows its code to be "cloned." Setting to **No** (def) will deny any request from TFTP clients.

Utilities/Exit

Write security: 5; Read security: 5

Activating this feature will exit the terminal session from the maintenance port or Telnet. It is equivalent to the key combination **Control L**.

Chapter 3: Terminal Menu Operation and Structure

Chapter 4

Specifications

SPECIFICATIONS AND FEATURES

This section describes the standard specifications and features incorporated in the Express L768/L1.5.

Network Interface

- RJ-45 for HDSL two-wire (Express L768) or four-wire (Express L1.5) service.
- Signal Format: 2B1Q
- Max distance per loop: 8000 feet at 26 AWG

Ethernet Interface (LAN)

Ethernet/IEEE 802.3 10BaseT.

Display

Available through terminal interface or Telnet session

Environmental

- Operating Temperature: 0 - 50 °C
- Storage Temperature: 20 - 70 °C
- Relative Humidity: Up to 95% non-condensing

Physical

- Dimensions: 1 1/2" H x 9" W x 6 1/4" D
- Weight: 9.5 oz.

Power

- 120 VAC, 60 Hz, 8 W typical

Chapter 4: Specifications

Appendix A

Loop Status Messages

The Express L768/L1.5 displays current loop status of the HDSL on the bottom center line of the terminal screen. The following messages are defined:

Connected

This is seen when the Express L768/L1.5 HDSL layer 1 is up. The rate is determined by what it is configured for under **Configuration/WAN/HDSL/Rate**.

Echo: Tx: X Rx: Y

The current transmit and receive count for the PPP echo request test.

Layer 1 up

The Express L768/L1.5's HDSL layer 1 is up.

Link down

The HDSL link is not synchronized.

Link In Sync

The HDSL link is synchronized but layer 1 is not up.

NET EOC LOOPBACK

Express L768/L1.5 has received an HDSL EOC loopback command from the far end.

RINGING

An incoming call is ringing.

Rate Status Messages

Displays the rate at which the connection has been established.

Appendix A: Loop Status Messages

Appendix B

Log Messages

The Express L768/L1.5 Logs menu contains messages of events that occur. The definitions for some of those log messages are as follows:

PPP Log Messages

BCP <X> down

level 5

Bridge Control Protocol port <X> has been dropped between Express L768/L1.5 and PPP peer.

BCP <X> up

level 5

Bridge Control Protocol port <X> has been successfully negotiated between Express L768/L1.5 and PPP peer.

CCP <X> down

level 5

Compression Control Protocol port <X> has been dropped between Express L768/L1.5 and PPP peer.

CCP <X> up

level 5

Compression Control Protocol port <X> has been successfully negotiated between Express L768/L1.5 and PPP peer.

CHAP authen failed

level 3

The PPP peer has rejected the Express L768/L1.5's username and/or password used for authenticating. Check to make sure the **Configuration/Connection List/Authentication** parameters **Tx Method**, **Tx Username**, and **Tx Password** are correct.

EAP authen failed

level 3

The PPP peer has rejected the Express L768/L1.5's username and/or password used for authenticating. Check to make sure the **Configuration/Connection List/Authentication** parameters **Tx Method**, **Tx Username**, and **Tx Password** are correct.

IPCP <X> down

level 5

IP Control Protocol port <X> has been dropped between Express L768/L1.5 and PPP peer.

IPCP <X> up

level 5

IP Control Protocol port <X> has been successfully negotiated between Express L768/L1.5 and PPP peer.

IPXCP <X> down

level 5

IPX Control Protocol port <X> has been dropped between Express L768/L1.5 and PPP peer.

IPXCP <X> up

level 5

IPX Control Protocol port <X> has been successfully negotiated between Express L768/L1.5 and PPP peer.

LCP <X> down

level 5

Link Control Protocol port <X> has been dropped between Express L768/L1.5 and PPP peer.

LCP <X> up

level 5

Link Control Protocol port <X> has been successfully negotiated between Express L768/L1.5 and PPP peer.

Link is looped back

level 3

The Express L768/L1.5 has dialed a location which is looping back all data. Essentially, it has negotiated PPP with itself.

Negot not converging

level 2

Negotiation of the LCP layer is unattainable due to misconfiguration or the Express L768/L1.5 or PPP peer is requiring authentication and the other is refusing.

No IP addr for peer

level 2

The Express L768/L1.5 cannot continue the connection because there was no IP address received from the PPP peer or it was not set in **Configuration/Connection List/IP/Route/IP/Net** parameter.

No Response from peer

level 2

The Express L768/L1.5 has dialed or answered a call and no PPP negotiation packets were seen.

PAP authen failed

level 3

The PPP peer has rejected the Express L768/L1.5's username and/or password used for authenticating. Check to make sure the **Configuration/Connection List/Authentication** parameters **Tx Method**, **Tx Username**, and **Tx Password** are correct.

Peer failed CHAP authen

level 3

The PPP peer's reported CHAP username and/or password does not match the Express L768/L1.5's parameters. This is most likely caused by PPP peer sending an incorrect username and/or password. Make sure the **Configuration/Connection List/Authentication** parameters **Rx Username** and **Rx Password** are correctly entered. Also, if using RADIUS, check that the server is configured and running properly.

Peer failed EAP authen

level 3

The PPP peer's reported EAP username and/or password does not match the Express L768/L1.5's parameters. This is most likely caused by PPP peer sending incorrect username and/or password. Make sure the **Configuration/Connection List/Authentication** parameters **Rx Username** and **Rx Password** are correctly entered. Also, if using RADIUS, check that the server is configured and running properly.

Peer failed PAP authen

level 3

The PPP peer's reported PAP username and/or password does not match the Express L768/L1.5's parameters. This is most likely caused by PPP peer sending incorrect username and/or password. Make sure the **Configuration/Connection List/Authentication** parameters **Rx Username** and **Rx Password** are correctly entered. Also, if using RADIUS, check that the server is configured and running properly.

Peer refused authen

level 3

The PPP peer would not allow the Express L768/L1.5 to authenticate it using the method set in Configuration/Security/PPP.

Peer refused SpanTree

level 4

The PPP peer would not participate in the Spanning Tree protocol. This is a warning message only. Bridging will still occur across the WAN port so care must be taken that no loop topologies exist across the connection.

PPPTx[x] ...

level 6

Advance debugging decode of transmitted PPP configuration packets.

PPPrx[x] ...

level 6

Advanced debugging decode of received PPP configuration packets.

Call Log Messages

Power Up - last down cause: <reason>

level 0 (displayed as level 1 after the unit is reset)

This is the <reason> for the last reset. Most are caused by internal errors. Possible reasons are:

Bus Error - Bad address occurred on the internal bus

Kernel error - General operating system error

No SBCs - Mail resources used up or lost

Router stack error - Fatal error in protocol stack
general panic - general error
no rip - rip tasks could not start
out of memory - out of available memory
out of TCP ports - all TCP ports are used up
unknown error - unknown fatal error has occurred
Set timer error - Cannot set real-time clock
Software Watch Dog Reset - Software watchdog was not updated

Network Log Messages

Attempting to add bad IP iface route: ifnum=<inter> dest=<ip>

level 4

An IP address <ip> could not be used for the interface number <inter>.

DHCP couldn't alloc mem

level 1

A DHCP response could not be generated due to memory allocation problems.

DHCP response sent

level 4

A DHCP response was successfully sent to requesting device.

DHCP socket failed

level 1

Internal error occurred when attempting to start DHCP server.

DHCP: Host not added to ARP table

level 2

The DHCP server could not add requesting host to ARP table.

**Installing bad default route: ifnum=<inter> metric=<hops>
gw=<ip>**

level 6

The Express L768/L1.5 did not install a default route because the <inter> or <hops> was zero.

**Rejecting packet with Source Routing option - src=<srcip>
dest=<destip>**

level 4

The Express L768/L1.5 has dropped a source routed IP packet due to invalid parameters.

setmask: local IP iface(0), not done

level 6

Debug error used in determining router stack problems.

syslog: bad host

level 2

Syslog function cannot use host name or IP set in Configuration/Logs/Syslog Host.

syslog: no port

level 2

Syslog function cannot open port to send Log entries.

TEL: Telnet Session Closed

level 4

Telnet server session has been closed.

telclient bad host

level 2

Telnet client could not use host name or IP address set in Configuration/Utilities/Telnet Client/Host.

telclient bad init

level 2

Telnet client could not initialize a session.

Telnet Client: Clr TCBF_BUFFER flag failed

level 6

Debugging message related to Telnet client function.

Telnet Client: Set TCBF_DONTBLOCK flag failed

level 6

Debugging message related to Telnet client function.

Telnet Client socket failed

level 2

Telnet client function could not open TCP socket.

Telnet server connect to <ip>

level 4

Telnet server has connected to Telnet client with IP address <ip>.

Telnet Session Closed

level 4

Telnet server has closed connection.

Telnet Session failed, error <errnum>

level 2

Telnet server could not connect to Telnet client due to error.

TELNETD: accept failed

level 2

Telnet server could not open TCP socket to incoming Telnet client.

TELNETD: Set TCPC_LISTENQ failed

level 6

Debugging message related to Telnet server function.

TELNETD: Clr TCBF_BUFFER flag failed

level 6

Debugging message related to Telnet client function.

TELNETD: could not obtain peer ip

level 2

Telnet server function could not get IP address of Telnet client.

TELNETD: Session failed, error

level 2

A Telnet server session has failed because of an error.

TELNETD: Set TCBF_DONTBLOCK flag failed

level 6

Debugging message related to Telnet client function.

TELNETD: SOCKET creation error

level 2

Telnet server could not be started due to TCP socket error.

TFTP: can't get to host

level 2

TFTP client could not get to host.

TFTP client: unable to open port

level 2

TFTP client function could not open a UDP port.

TFTP: error rcvd - <message>"

level 2

Received error with <message> from TFTP server.

TFTP: lost communication

level 2

Lost communication to TFTP client or server during transfer.

TFTP server: unable to open port

level 2

TFTP server function could not open a UDP port.

Appendix C

SNMP

Understanding SNMP

As Local Area Network (LAN) environments became standardized over the past ten years, multi-vendor equipment grew with competition. It became necessary to manage the various vendor equipment from a single control console. Thus, the Simple Network Management Protocol (SNMP) emerged as the *de facto* standard for managing commercial Transmission Control Protocol/Internet Protocol (TCP/IP) networks.

The term *SNMP* broadly refers to the message protocols used to exchange information between the network and the managed devices, as well as to the structure of network management databases. SNMP has three basic components:

- **Network Manager:** This is a control program that collects, controls, and presents data pertinent to the operation of the network devices. It resides on a network management station.
- **Agent:** This is a control program that responds to queries and commands from the network manager and returns requested information or invokes configuration changes initiated by the manager. It resides in each network device connected.
- **MIB:** This is an index to the organized data within a network device. It defines the operating parameters that can be controlled or monitored.

When requesting the network manager to retrieve or modify a particular piece of information about a network device, the network manager transmits the request to that network device. The agent in that device interprets the incoming request, performs the requested task, and sends its response to the network manager. The network manager collects all the data from the various network devices and presents it in a consistent form.

Using SNMP Version 1, the network manager can issue three types of commands:

- **GetRequest:** This command retrieves a single item or the first in a series from a network device.
- **GetNextRequest:** This command retrieves the next item in a series from a network device.
- **SetRequest:** This command writes information to a network device.

The network device issues two types of messages:

- **GetResponse:** This message is the response to a network manager **GetRequest** or **GetNextRequest** command.
- **Trap:** This is an unsolicited message issued by a network device to report an operational anomaly or an alarm condition to the network manager.

These messages are typically encased within informational packets and transported over the LAN or WAN.

SNMP Embedded Agent

The Express L768/L1.5 supports the following groups from MIB-II: (RFC 1213)

- System Group
- UDP Group
- Interfaces Group
- ICMP Group
- Address Translation Group
- IP Group
- TCP Group

Also, the Ethernet transmission MIB is supported (RFC 1643).

The following manager requests are supported:

- Get object
- Get next object
- Set object

Communities

The Express L768/L1.5 permits up to eight communities to be defined. The privilege level of each community can be set. The default community is public with read-only privileges. When the IP address is all zeros, any manager of the community can access the Express L768/L1.5.

Traps

Up to four hosts can be set to receive traps. Each host entry requires an IP address of the manager.

Trap types supported are: cold start, link up, link down, and authentication failure.

Appendix C: SNMP

Appendix D

Connector Pinouts

Table D-A
IBM/AT Style EIA-232 Interface

	Pin	Name	I/O	Description
	1	CD	N/C	Carrier Detect
	2	RD	O	Receive Data
	3	TD	I	Transmit Data
	4	DTR	N/C	Data Terminal Ready
	5	GND	N/A	Signal Ground
	6	DSR	N/C	Data Set Ready
	7	RTS	I	Request to Send
	8	CTS	O	Clear to Send
	9	RI	N/C	Ring Indicator

I = Input O = Output N/A = Not Applicable N/C = Not Connected

Table D-B
RJ-45 HDSL BRI U



	Pin	Description
	Pin 1	Loop 1
	Pin 2	Loop 1
	Pin 3	no connection
	Pin 4	Loop 2 (Express L1.5 only)
	Pin 5	Loop 2 (Express L1.5 only)
	Pin 6	no connection
	Pin 7	no connection
	Pin 8	no connection

Table D-C
10BaseT Ethernet

		Switch Position	
		TO NIC	TO HUB
	Pin 1	TX1	RX1
	Pin 2	TX2	RX2
	Pin 3	RX1	TX1
	Pin 6	RX2	TX2



*The switch position can be set for either **TO NIC** or **TO HUB** on the back panel of the Express L768/L1.5. The rear panel is illustrated in Figure 1-6 on page 11.*

Appendix E

Terminal Mode Commands

The Express L768/L1.5 supports a command line interface. All menu options are configurable and readable from the terminal mode. Additional commands are also available.

Menu Commands

Every menu item in the menu structure can be accessed through the terminal mode interface. Terminal commands are as follows:

```
top_menu sub_menu1 sub_menu2 ... config_item
```

Each config_item is entered as shown below.

TYPE:	ENTERED AS:
string	printable characters within double quotes
password	printable characters within double quotes
IP address	xx.xx.xx.xx (0..9) separated by '.'
Hex	xx:xx:xx:xx (0..9,a..f) separated by ':'
enum	sub-string or [#index]
unsigned	digits (0..9)
date	mm-dd-yyyy
time	hh:mm:ss
date/time	mm-dd-yyyy hh:mm:ss
activator	read only
list	followed by index with first record being 1
array	followed by index with first record being 1

One of the following key words must be used first:

info	Goes directly to Configuration/System Info menu.
hdsl	Goes directly to Configuration/WAN/HDSL menu.
ip	Goes directly to Configuration/IP menu.
ipx	Goes directly to Configuration/IPX menu.
bridge	Goes directly to Configuration/Bridge menu.
security	Goes directly to Configuration/Security menu.
ppp	Goes directly to Configuration/PPP Profile menu.
telnet	Goes directly to Configuration/Management/Telnet menu.
snmp	Goes directly to Configuration/Management/SNMP menu.
maint	Goes directly to Configuration/Management/Maint menu.
status	Goes directly to Configuration/Status menu.
test	Goes directly to Configuration/Test menu.
logs	Goes directly to Configuration/Logs menu.
util	Goes directly to Configuration/Utilities menu.
frame	Goes directly to Configuration/WAN/Frame Relay menu

Some examples are listed below:

telnet user 1 name "guest"	sets user name for Telnet user list entry 1 to "guest"
test 2047	starts 2047 test
status ip 1 gateway	returns the gateway address for IP route table entry 1

Additional Commands

Other commands available from the terminal mode are given below:

save	Saves the configuration to non-volatile RAM (flash).
mac	Returns the MAC address for the Express L768/L1.5.
version	Returns the firmware version and routing stack version.
reset	Resets the unit.
exit	Leaves terminal mode and returns to menus.
download	Downloads complete configuration to the terminal screen for capture.

Download/Uploading Configuration

The Express L768/L1.5's configuration can be captured to a text file using the download command. The text file can be edited if required. Upload of the configuration can be accomplished by sending the text file to the Express L768/L1.5 in terminal mode. A baud rate of 9600 is strongly recommended when uploading. As soon as the upload has been completed, type "save" to save the new configuration to flash. A "reset" command or power cycle 10 seconds after the save command is recommended to ensure that the new configuration is complete.

Appendix E: Terminal Mode Commands

Glossary

10Base2

IEEE 802.3 specification, similar to Ethernet, using thin coaxial cable that runs at 10 Mbps, with a maximum distance of 185 meters per segment. Also known as Thin Ethernet or Thinwire Ethernet.

10BaseT

IEEE 802.3 specification, using unshielded twisted-pair cabling and running at 10 Mbps.

AEP

AppleTalk Echo Protocol. Allows a node on an AppleTalk network to send a packet to another node and in return, receive an echoed copy of the packet.

ARP

Address Resolution Protocol. Used for resolving physical address when IP address is unknown.

B-Channel

64 kbps bearer channel used for voice, circuit, or packet switched data.

bearer service

As defined by CCITT standards, a type of telecommunication service that provides the capability for the transmission of information between user-to-network interfaces. Bearer services defined for ISDN are circuit mode and packet mode.

BOOTP

The Bootstrap Protocol allows a network node to determine certain startup information such as its IP address.

Bridge

A data communications device that connects two or more networks. A bridge stores and forwards complete packets between the networks. Bridges operate at the data-link layer of the OSI model.

CCITT

Consultative Committee on International Telephony and Telegraphy. A body of the International Telegraph Union (ITU) which prepares recommendations, commonly referred to as international standards, to resolve technical telegraph and telephone problems.

central office (CO)

In telephony, the phone company switching facility or center, usually a Class 5 end office, at which subscribers local loops terminate. Handles a specific geographic area, identified by the first three digits of the local telephone number. Usually the facilities of the local BOC.

CSMA/CD

Carrier Sense Multiple Access Collision Detect. A channel access mechanism where devices check the channel for a carrier before transmitting. If no carrier is sensed for the specified period of time, the device can transmit. If two devices transmit at once, a collision occurs and is detected by all colliding devices. This collision subsequently delays their retransmissions for a random length of time. CSMA/CD is used by Ethernet and IEEE 802.3.

D-channel

The ISDN channel that carries signalling information to control the call setup, teardown, or invocation of supplementary services. The D-Channel may also be used to provide packet mode data service.

DDS

Dataphone Digital Service. AT&T private line service for transmitting data over a digital system. The digital transmission system transmits electrical signals directly, instead of translating the signals into tones of varied frequencies as with traditional analog transmission systems. Digital techniques provide more efficient use of transmission facilities, resulting in lower error rates and costs than analog systems.

digital hub

Designated office where DDS channels are interconnected and where synchronous network timing, testing access, and additional service features are provided.

DLCI

Data Link Connection Identifier. Identifies each virtual circuit with a shared physical channel.

Ethernet

A local area network used for connecting computers, printers, workstations, a terminals, servers, etc., within the same building or campus. Ethernet operates over twisted wire and coaxial cable at speeds up to 10 Mbps. Ethernet specifies a CSMA/CD.

four-wire circuits

Telephone lines using two wires for transmitting and two wires for receiving, offering much higher quality than a 2-wire circuit. All long distance circuits are 4-wire. Almost all local phone lines and analog phones are 2-wire.

Frame Relay

A streamlined subset of the X.25 packet switching protocol which has been used by many corporations for wide area communications for a number of years.

group 4

A high-speed (56 kbps) facsimile protocol specific to ISDN.

HDSL

High-bit-rate Digital Subscriber Line technology is similar to ISDN U-interface, but operates at a higher bit rate. It provides bi-directional DS1 service over two copper pairs.

hop count

A routing metric used to measure the distance between a source and a destination. Particularly used by RIP.

hub

(1) Communications center, (2) Major routing station for connecting channels, (3) DDS connecting center.

IARP

Inverse Address Resolution Protocol. Used for resolving the protocol address when the hardware address is known.

IEEE

Institute of Electrical and Electronic Engineers. Professional organization that defines network standards. IEEE LAN standards are the predominant LAN standards today and include protocols similar or virtually equivalent to Ethernet and Token Ring.

IEEE 802.1d

An algorithm used to prevent bridging loops by creating a spanning tree.

IEEE 802.2

An IEEE LAN protocol that specifies an implementation of the LLC sublayer of the data link layer. It handles errors, framing, flow control, network layer (Layer 3) service interface, and is used in LANs.

IEEE 802.3

A physical layer standard specifying a linear bus network LAN with a CSMA/CD access method on a bus topology. Ethernet follows the 802.3 standard, transmitting at 10 megabits per second. This is the most common local area network specification. Physical variations of IEEE 802.3 include 10Base2 and 10BaseT.

in-band signalling

Signalling made up of tones which pass within the voice frequency band and are carried along the same circuit as the talk path being established by the signals. Virtually all signalling (request for service, dialing, disconnect, etc.) in the U.S. is in-band signalling. Most of that signalling is MF (Multi-Frequency) dialing. The more modern form of signalling is out-of-band.

interexchange carrier

Since divestiture, any carrier registered with the FCC authorized to carry customer transmissions between LATAs interstate, or if approved by a state public utility commission, intrastate. Includes carriers such as AT&T Communications, Satellite Business Systems, GTE Telenet, GTE Sprint, and MCI.

information element

The name for the data fields within an ISDN Layer 3 message.

interworking

Communication between two types of networks or end equipment. This may or may not involve a difference in signalling or protocol elements supported.

Internet Protocol

A TCP/IP protocol describing software that tracks the Internet address of nodes, routes outgoing message, and recognizes incoming messages. Used in gateways to connect networks at OSI network Level 3 and above.

IPX

Internetwork Packet Exchange. A Novell NetWare protocol used to move information across networks.

ISDN

Integrated Services Digital Network. A network architecture that enables end-to-end digital connections. The network supports diverse services through integrated access arrangements and defines a limited set of standard, multipurpose interfaces for equipment vendors, network providers, and customers. Interworking with a public switched telephone network is retained.

jabber

An error condition in which a network device continually transmits garbage onto the network. In IEEE 802.3, a data packet whose length exceeds that prescribed in the standard.

jitter

The slight movement of a transmission signal in time or phase that can introduce errors and loss of synchronization for high-speed synchronous communications. See phase jitter.

LATA

Local Access and Transport Area. One of 161 local telephone serving areas in the United States, generally encompassing the largest standard statistical metropolitan areas. Subdivisions established as a result of the AT&T divestiture that now distinguish local from long distance service. Circuits with both endpoints within the LATA (intraLATA) are generally the sole responsibility of the local telephone company, while circuits that cross outside the LATA (interLATA) are passed on to an interexchange carrier.

loopback

A diagnostic procedure where data is sent to the device being tested, and the output of the device is fed directly back to its input, looped around, and the returning data is checked against that which was sent.

Media Access Control (MAC)

As defined by the IEEE, the lower of the two sublayers of the OSI reference model data link layer. The MAC sublayer is concerned with media access issues, such as whether token passing or contention is used.

message

The Layer 3 information that is passed between the CPE and SPCS for signaling.

multipoint line

A communications line having multiple cable access points.

Name Binding Protocol (NBP)

The AppleTalk transport-level protocol that translates a character string name into the internet address of the corresponding socket client; NBP enables AppleTalk protocols to understand user-defined zones and device names by providing and maintaining translation tables that map these names to corresponding socket addresses.

NAT

Network Address Translation occurs at the borders of stub domains. Its purpose is to translate the IP address of passing packets by changing all references of one IP address to another. Translation is performed as per RFC 1631.

netmask

A 32-bit bit mask which shows how an Internet address is to be divided into network, subnet, and host parts. The netmask has ones in the bit positions in the 32-bit address which are to be used for the network and subnet parts, and zeros for the host part. The mask should contain at least the standard network portion (as determined by the address's class), and the subnet field should be contiguous with the network portion.

non-ISDN line

Any connection from a CPE to a SPCS that is not served by D-Channel signaling.

non-ISDN trunk

Any trunk not served by either SS7 or D-Channel signalling.

NT1

Network Termination 1. A unit that provides physical and electromagnetic termination of the U-interface 2-wire transmission line, converts between Layer 1 formats used at the U- and T- reference points, and performs some maintenance functions.

phase jitter

In telephony, the measurement in degrees out-of-phase that an analog signal deviates from the reference phase of the main data-carrying signal. Often caused by alternating current components in a telecommunications network.

point-to-point protocol (PPP)

An implementation of TCP/IP which is intended for transmission using telephone lines. PPP provides router-to-router and host-to-network connections over both synchronous and asynchronous circuits.

poison routes

Routes which have an infinite metric which to other routers means the network for the route is inaccessible.

PRA

Primary Rate Access. Connects high-capacity CPE, such as PBXs, to the network. In the US, this is composed of twenty-three 64 kbps channels and one 64 kbps D-channel. Also known as Primary Rate Interface (PRI).

RFC1490

Request for Comments document which describes an encapsulation method for carrying network interconnect traffic over a Frame Relay backbone.

RIP

Routing Information Protocol. A protocol used to exchange routing information among a set of computers connected by a LAN. RIP uses hop counts as a routing metric.

router

An interface which finds the best route between two networks. Routers forward packets from one network to another, based on network layer information.

routing metric

The method by which a routing algorithm determines one route is better than another. This information is stored in routing tables. Such tables include reliability, delay bandwidth, load, MTUs, communication costs, and hop count.

RS-232-C

An EIA-specified physical interface with associated electrical signalling between DCE and DTE. The most commonly employed interface between computer devices and modems.

RTMP

Routing Table Maintenance Protocol. The AppleTalk protocol used to establish and maintain the routing information that is required by internet routers in order to route datagrams from any source socket to any destination socket in the internet. Using RTMP, internet routers dynamically maintain routing tables to reflect changes in internet topology.

service advertising protocol (SAP)

An IPX protocol through which network resources such as servers become known to clients.

servicing area

Region surrounding a broadcasting station where signal strength is at or above a stated minimum. The geographic area handled by a telephone central office facility. Generally equivalent to a LATA.

SNMP

Simple Network Management Protocol. SNMP provides a means to monitor and set network configuration and runtime parameters.

spanning tree

A loop-free subset of the topology of a network.

SPCS

Stored Program Controlled Switch. A digital switch that supports call control, routing, and supplementary services provision under software control. All ISDN switches are SPCSs.

spoofing

Spoofing reduces the required bandwidth by having devices, such as bridges or routers, answer for the remote devices. This causes the remote LAN to appear as if it is still connected to the LAN device even though it is not. The spoofing saves the WAN bandwidth, because no packet is ever sent out on the WAN.

synchronous

(1) The condition occurring when two events happen in a specific time relationship with each other, both under control of a master clock; (2) A method of data transmission requiring the transmission of timing pulses to keep the sender and receiver synchronized in their communication used to send blocks of information. Synchronous data transmission is used in high speed data circuits because there is less overhead than asynchronous transmission of characters which contain two extra bits per character to effect timing.

T1

Also T-1. A digital transmission link with a capacity of 1.544 Mbps. T1 uses two pairs of normal twisted wires. T1 normally can handle 24 voice conversations with each conversation being digitized at 64 kbps. With more advanced digital voice encoding techniques, it can handle more voice channels. T1 is a standard for digital transmission in North America.

TA

Terminal Adaptor. A DCE that connects to the ISDN S-Interface and enables non-ISDN terminal equipment to communicate over the ISDN.

TE1

Terminal Equipment Type 1. ISDN-compatible terminals.

Telnet

The TCP/IP standard protocol for remote terminal connection service. Telnet allows a user at one site to interact with a remote timesharing system at another site as if the user's terminal were connected directly to the remote machine.

TCP/IP

Transmission Control Protocol/Internet Protocol. A set of protocols developed by the Department of Defense to link dissimilar computers across many kinds of networks.

twisted pair

Two wires twisted around each other to reduce induction (interference) from one wire to the other. Several sets of twisted pair wires may be enclosed in a single cable. Twisted pair is the normal cabling from a central office to your home or office, or from your PBX to your office phone. Twisted pair wiring comes in various thicknesses. As a general rule, the thicker the cable is, the better the quality of the conversation and the longer cable can be and still get acceptable conversation quality. However, the thicker it is, the more it costs.

2B+D

The Basic Rate Interface (BRI) in ISDN. A single ISDN circuit divided into two 64 kbps digital channels for voice or data and one 16 kbps channel for low speed data (up to 9,600 baud) and signalling. 2B+D is carried on one or two pairs of wires depending on the interface, the same wire pairs that today bring a single voice circuit into your home or office. See ISDN.

23B+D

In ISDN, also known as the Primary Rate Interface. A circuit with a wide range of frequencies that is divided in twenty-three 64 kbps paths for carrying voice, data, video, or other information simultaneously. It bears a remarkable similarity to today's T1 link, except that T1 carries 24 voice channels. In ISDN, 23B+D gives twenty-three channels and one D channel for out-of-band signalling. However, in T1, signalling is handled in-band. See ISDN.

two-wire circuit

A transmission circuit composed of two wires, signal and ground, used to both send and receive information. In contrast, a 4-wire circuit consists of two pairs. One pair is used to send and one pair is used to receive. All trunk circuits (long distance) are 4-wire. A 4-wire circuit delivers better reception, but also costs more. All local loop circuits (those coming from a Class 5 central office to the subscriber's phone system) are 2-wire, unless a 4-wire circuit is requested.

U-interface

A twisted pair subscriber loop that connects the NT1 reference point to the ISDN network, as defined in the I.411 Recommendation. This interface provides Basic Rate Access with an operating frequency of 160 kbps and an information rate of 144 kbps. Under U.S. regulations, this also marks the line of demarcation between customer-owned equipment and the public network.

ZIP

Zone Information Protocol. The AppleTalk session-layer protocol used to maintain and discover the internet-wide mapping of network number ranges to zone names.

Zombie Routes

Routes that have been identified by the router to be deleted. They remain in the router's route table for a specified amount of time with an infinite metric so that all other routers will learn of this router's intention to delete them.

Glossary

Acronyms

AEP	AppleTalk Echo Protocol
AMI	Alternate Mark Inversion
ARP	Address Resolution Protocol
B (Channel)	A 64 kbps digital information channel
BCP	Bridge Control Protocol
BONDING	Bandwidth On Demand Interoperability Group
BOOTP	Bootstrap Protocol
BPDU	Bridging Protocol Data Unit
bps	Bits per second
Bps	Bytes per second
BRI	Basic Rate Interface
CA	Call Appearance
CCP	Compression Control Protocol
CCITT	Consultative Committee for International Telegraphy and Telephony
CD	Carrier Detect
CPE	Customer Premises Equipment
CRC	Cyclic Redundancy Check
CSMA/CD	Carrier Sense Multiple Access Collision Detect
DHCP	Dynamic Host Configuration Protocol
DLCI	Data Link Connection Identifier
DMS	Digital Multiplex Switching
DTE	Data Terminal Equipment
DTMF	Dual Tone Multi-Frequency
EKTS	Electronic Key Telephone Service
ESS	Electronic Switching System
FAX	Facsimile
FEBE	Far End Block Errors
FTP	File Transfer Protocol
HDSL	High-Bit-Rate Digital Subscriber Line
HTU-C	HDSL Terminal Unit-Central
HTU-R	HDSL Terminal Unit-Remote
ICMP	Internet Control Message Protocol
ID	Identification
IETF	Internet Engineering Task Force
I/O	Input/Output
IP	Internet Protocol

Acronyms

IPCP	Internet Protocol Control Protocol
IPX	Internetwork Packet Exchange
I²L	Integrated Injected Logic
IEC	Inter-Exchange Carrier
ISDN	Integrated Services Digital Network
ISO	International Standardization Organization
ISP	Internet Service Provider
kbps	Kilobits per second
kHz	Kilohertz
LAN	Local Area Network
LCP	Link Control Protocol
LDN	Local Directory Number
MAC	Media Access Control
MIB	Management Information Base
MP	Multilink Protocol
MRU	Maximum Receivable Unit
MRRU	Maximum Receivable Reconstructable Unit
NBP	Name Binding Protocol
NEBE	Near End Block Errors
NIC	Network Interface Card
NI-1	National ISDN-1
NT	Network Termination
PBX	Private Branch Exchange
PC	Personal Computer
PING	Packet InterNet Groper
POTS	Plain Old Telephone Service
PPP	Point-to-Point Protocol
PRI	Primary Rate Interface
RFC	Request For Comments
RIP	Routing Information Packet, Routing Information Protocol
RTMF	Routing Table Maintenance Protocol
SAP	Service Advertising Protocol
SNMP	Simple Network Monitoring Protocol
SPCS	Stored Program Controlled Switching System
SPID	Service Profile Identifier
TCP	Transmission Control Protocol
TEI	Terminal Endpoint Identifier
TFTP	Trivial File Transfer Protocol
UDP	User Datagram Protocol
WAN	Wide Area Network
ZIP	Zone Information Protocol

Numerics

10-base-T interface 104
2047 loopback 78

A

address table 41
address table/aging 41
address table/forward policy 41
ADTRAN frame port 768 6
agent 99, 100
applications
 frame relay connectivity to ADT-
 RAN frame port 768 6
 single user to corporate LAN 5
 SOHO to corporate LAN 7
ARP cache 73
authentication 42, 56
 with Express XL/XLT as authenticator 56
authentication/Rx password 57
authentication/Rx username 57
authentication/Tx method 57
authentication/Tx password 57
authentication/Tx username 57

B

baud rate 68
bridge 61
bridge group 1 40
bridge group 1/active 40
bridge group 1/path cost 40

bridge group 1/priority 40
bridge group 2/active 40
bridge group 2/path cost 41
bridge group 2/priority 41
bridge map/active 53
bridge map/bridge group 53
bridge menu 36
bridge mode 8
bridge table 74
bridge/address table 41
bridge/mode 36, 61
bridge/spanning tree 38
bridge/WAN IP bridge 36
bridge/WAN IPX bridge 37
bridging 8
 concurrent routing and bridging 9
 demand 8

C

call log messages 94
channel rate 24
CHAP 44, 57
command line interface 105
command prompt mode 69
commands 107
communities 101
communities/manager IP 67
communities/name 67
communities/privilege 67
concurrent routing and bridging 9
configuration 11
 downloading/uploading 107

configuration menu 15, 22
configuration/bridge 36
configuration/frame relay 48
configuration/IP 26
configuration/IPX 33
configuration/management 65
configuration/management menu 65
configuration/PPP profile 56
configuration/security 42
configuration/system info 22
configuration/terminal mode 69
configuration/WAN 24
connection
 LAN 14
connection list profile
 deleting 50
connection log 80
connection log/active 80
connection log/clear 81
connection log/level 81
connection log/view 81
connection log/wrap 81
connector pinouts 103
corporate LAN 5, 7
customer and product service 13

D

data bits 69
date/time 23
default gateway 26
demand bridging 8
demand routing 8
DHCP mode 29
display 87
DLCI mapping 49
DLCI mapping/active 50
DLCI mapping/bridge map 53
DLCI mapping/DLCI 50
DLCI Mapping/filters 54
DLCI mapping/IP map 50

DLCI mapping/IPX map 52
DLCI table 72
DNS 30
DNS server 30
DNS/domain name 30
DNS/server 1 30
DNS/server 2 30
domain name 30
download/uploading configuration 107

E

EAP 44, 57
echo request 78
EIA-232 interface 103
embedded agent 100
environmental specifications 87
Ethernet interface 104
Ethernet interface (LAN) 87
Express L768/L1.5 overview 4

F

factory default 8
features 87
FEBE 25
FEBEs 25
filter
 setting up 44
filter defines 44
filter defines /IP filter defines 46
filter defines /IPX filter defines 47
filter defines /MAC filter defines 45
filter defines /pattern filter defines 45
filters 54, 62
filters/in exceptions 54, 63
filters/In from PVC 54
filters/LAN-to-WAN (out) 64
filters/out exceptions 55, 64
filters/Out to PVC 55
filters/WAN-to-LAN (in) 62

- firmware revision 23
 - forward delay 39
 - frame relay 8, 48
 - frame relay connectivity to ADTRAN
 - frame port 768 6
 - frame relay/DLCI mapping 49
 - frame relay/maintenance protocol 49
 - frame relay/polling frequency 49
 - frame type 34
 - front panel 10
 - front panel indicators 10
- G**
- GetNextRequest 100
- H**
- HDSL
 - network connection 13
 - overview 3, 13
 - setting up the line 1
 - HDSL/channel rate 24
 - HDSL/FEBEs 25
 - HDSL/mode 24
 - HDSL/NEBEs 25
 - hello time 39
- I**
- indicators 10
 - installation 13
 - interface
 - Ethernet 87
 - network 87
 - IP filter defines 46
 - IP map/active 50
 - IP map/far-end IP address 51
 - IP map/IARP 51
 - IP map/IP netmask 51
 - IP map/link IP address 51
 - IP Map/NAT 52
 - IP map/RIP direction 52
 - IP map/RIP method 52
 - IP map/RIP protocol 51
 - IP menu 26
 - IP router 8, 28
 - IP router/mode 28
 - IP routes 74
 - IP routing 9
 - IP stats 77
 - IP/default gateway 26
 - IP/DNS 30
 - IP/IP address 26
 - IP/IP router 28
 - IP/mode 58
 - IP/NAT 29, 58
 - IP/proxy ARP 32
 - IP/RIP 28, 59
 - IP/route 58
 - IP/static routes 27
 - IP/subnet mask 26
 - IP/UDP relay 31
 - IPX filter defines 47
 - IPX map/active 52
 - IPX map/IARP 53
 - IPX map/link network 53
 - IPX menu 33
 - IPX router 8
 - IPX routes 75
 - IPX routing 9
 - IPX servers 75
 - IPX/frame type 34
 - IPX/mode 33, 60
 - IPX/network 33
 - IPX/remote network 60
 - IPX/RIP timer 34
 - IPX/SAP timer 35
 - IPX/seed status 34
 - IPX/triggered 60
 - IPX/type 20 packets 60

L

- L2 protocol 25
- LAN bridge 7
- LAN connection 14
- LAN port 39
- LAN port/active 39
- LAN port/path cost 40
- LAN port/priority 40
- LAN stats 76
- LEDs 10
- log messages 91
- logs menu 17, 79
- logs/connection log 80
- logs/network log 81
- logs/PPP log 79
- logs/sys log host 79
- loop status messages 89

M

- MAC addresses 7
- MAC bridging 8
- MAC filter defines 45
- maint port/baud rate 68
- maint port/data bits 69
- maint port/parity 69
- maint port/password 68
- maint port/password protect 68
- maint port/stop bits 69
- maintenance port 68
- maintenance protocol 49
- management 65
- management/maint port 68
- management/SNMP 67
- management/Telnet 65
- maximum age 39

- menu commands 105
- menu structure 15
- MIB 99
- mode 9, 24

N

- NAT 8, 29, 30
- NAT mode 9
- NAT/Default IP 30
- NAT/DHCP mode 29
- NAT/DHCP renewal time 29
- NAT/web server 29
- NEBE 25
- NEBEs 25
- network connection
 - HDSL 13
- network device
 - GetResponse 100
- network interface 87
- network log 81
- network log messages 95
- network log/active 81
- network log/clear 82
- network log/level 82
- network log/view 82
- network log/wrap 81
- network manager 99
 - GetRequest 100
- none 28

P

- packets
 - filtering 44
- PAP 44, 57
- parity 69
- password 66, 68
- pattern filter defines 45

- physical specifications 87
 - ping 83
 - poison reverse 28, 59
 - polling frequency 49
 - power requirements 87
 - PPP 8, 44, 61
 - PPP log 79
 - PPP log messages 91
 - PPP log/active 80
 - PPP log/clear 80
 - PPP log/level 80
 - PPP log/view 80
 - PPP log/wrap 80
 - PPP peer 30
 - PPP profile 42, 56
 - PPP profile/authentication 56
 - PPP profile/bridge 61
 - PPP profile/filters 62
 - PPP profile/IP 58
 - PPP profile/IPX 60
 - PPP profile/PPP 61
 - PPP/max config 62
 - PPP/max failure 62
 - PPP/max timer 62
 - PPP/VJ compression 61
 - proxy ARP 32
- Q**
- quick startup guide 1
- R**
- Radius 42, 66
 - Radius server 43
 - radius server/primary server 43
 - radius server/retry count 43
 - radius server/secondary server 43
 - radius server/secret 43
 - radius server/UDP port 43
 - rate status messages 89
 - rear panel 11
 - RIP 8, 9, 28, 59
 - RIP timer 34
 - RIP/direction 29, 59
 - RIP/method 28, 59
 - RIP/mode 28, 59
 - RIP/protocol 28, 59
 - RIP/triggered 60
 - RIP/V2 secret 29
 - RJ-45 interface 103
 - route/force IP 59
 - route/IP/net 58
 - route/netmask 58
 - routing
 - concurrent routing and bridging 9
 - demand 8
 - IP 9
 - IPX 9
 - Rx only 29
- S**
- SAP 8, 9
 - SAP timer 35
 - security 12
 - security levels 21
 - security menu 42
 - security/authentication 42
 - security/filter defines 44
 - security/PPP 44
 - security/radius server 43
 - seed status 34
 - sessions 71
 - sessions/DLCI table 72
 - sessions/PPP session 71
 - sessions/spanning tree 73
 - SetRequest 100
 - signal format 87
 - SNMP 67, 99
 - SNMP access 67

-
- SNMP/communities 67
 - SNMP/traps 68
 - SOHO (small office - home office) 7
 - spanning tree 38, 73
 - spanning tree algorithm 7, 8, 38
 - spanning tree/bridge group 1 40
 - spanning tree/bridge group 2 40
 - spanning tree/forward delay 39
 - spanning tree/hello time 39
 - spanning tree/LAN port 39
 - spanning tree/maximum age 39
 - spanning tree/mode 38
 - spanning tree/priority 39
 - specifications 87
 - environmental 87
 - physical 87
 - split horizon 28, 59
 - static routes/active 27
 - static routes/gateway 27
 - static routes/hops 27
 - static routes/IP address 27
 - static routes/private 27
 - static routes/subnet mask 27
 - status menu 17, 70
 - status/ARP cache 73
 - status/bridge table 74
 - status/IP routes 74
 - status/IP stats 77
 - status/IPX routes 75
 - status/IPX servers 75
 - status/LAN stats 76
 - status/sessions 71
 - status/WAN stats 76
 - stop bits 69
 - subnet mask 26
 - switch position 104
 - system contact 23
 - system info menu 22
 - system location 22
 - system name 22
 - system uptime 23
- T**
- T1 overview 13
 - Telnet 12, 65
 - Telnet client 84
 - Telnet/server access 65
 - Telnet/user list 66
 - terminal menu
 - navigating 18
 - structure 15
 - top level 16
 - terminal mode 69
 - terminal mode commands 105
 - test menu 17, 78
 - test menu/2047 loopback 78
 - test menu/echo request 78
 - TFTP 84
 - TFTP host 84
 - transfer methods 84
 - Trap 100
 - traps 101
 - traps/manager IP 68
 - traps/manager name 68
 - Tx and Rx 29
 - Tx methods 57
 - Tx only 29
 - type 20 packets 60
- U**
- UDP port type 31
 - UDP relay 31
 - UDP relay list 31
 - UDP relay list/relay address 31
 - UDP relay list/UDP port type 31

-
- UDP relay list/UDP ports 1, 2, 3 31
 - UDP relay/mode 31
 - UDP relay/UDP relay list 31
 - upgrade menu 84
 - upgrade/abort transfer 85
 - upgrade/filename 84
 - upgrade/start transfer 85
 - upgrade/status 84
 - upgrade/TFTP host 84
 - upgrade/TFTP server 85
 - upgrade/transfer method 84
 - user list 66
 - user list/authen method 66
 - user list/idle time 66
 - user list/level 66
 - user list/name 66
 - user list/password 66
 - using keyboard to navigate menu 19
 - utilities menu 17, 83
 - utilities/exit 85
 - utilities/ping 83
 - utilities/Telnet client 84
 - utilities/upgrade menu 84
- V**
- VJ compression 61
- W**
- WAN IP bridge 36
 - WAN IP bridge proxy ARP 37
 - WAN IP bridge/netmask 37
 - WAN IP bridge/network 37
 - WAN IP bridge/triggered 37
 - WAN IPX bridge 37
 - WAN IPX bridge/frame type 38
 - WAN IPX bridge/network 38
 - WAN IPX bridge/seed status 38
 - WAN IPX bridge/triggered 38
 - WAN menu 24
 - WAN stats 76
 - WAN/HDSL 24
 - WAN/L2 protocol 25

X

- xmodem 84

Index

Product Support Information

Presales Inquiries and Applications Support

Please contact your local distributor, ADTRAN Applications Engineering, or ADTRAN Sales:

Applications Engineering	(800) 615-1176
Sales	(800) 827-0807

Post-Sale Support

Please contact your local distributor first. If your local distributor cannot help, please contact ADTRAN Technical Support and have the unit serial number available.

Technical Support	(888) 4ADTRAN
-------------------	---------------

Repair and Return

If ADTRAN Technical Support determines that a repair is needed, Technical Support will coordinate with the Customer and Product Service (CAPS) department to issue an RMA number. For information regarding equipment currently in house or possible fees associated with repair, contact CAPS directly at the following number:

CAPS Department	(256) 963-8722
-----------------	----------------

Identify the RMA number clearly on the package (below address), and return to the following address:

ADTRAN, Inc.
CAPS Department
901 Explorer Boulevard
Huntsville, Alabama 35806

RMA # _____