

**SEHI-22, SEHI-24, SEHI-32, AND SEHI-34
10BASE-T INTELLIGENT STACKABLE HUB**

USER'S GUIDE

CABLETRON
SYSTEMS^{INC.}

The Complete Networking Solution™

CABLETRON SYSTEMS, P. O. Box 5005, Rochester, NH 03867-0505

NOTICE

Cabletron Systems reserves the right to make changes in specifications and other information contained in this document without prior notice. The reader should in all cases consult Cabletron Systems to determine whether any such changes have been made.

The hardware, firmware, or software described in this manual is subject to change without notice.

IN NO EVENT SHALL CABLETRON SYSTEMS BE LIABLE FOR ANY INCIDENTAL, INDIRECT, SPECIAL, OR CONSEQUENTIAL DAMAGES WHATSOEVER (INCLUDING BUT NOT LIMITED TO LOST PROFITS) ARISING OUT OF OR RELATED TO THIS MANUAL OR THE INFORMATION CONTAINED IN IT, EVEN IF CABLETRON SYSTEMS HAS BEEN ADVISED OF, KNOWN, OR SHOULD HAVE KNOWN, THE POSSIBILITY OF SUCH DAMAGES.

© Copyright February 1994 by:
Cabletron Systems, Inc.
P.O. Box 5005, Rochester, NH 03867-0505

All Rights Reserved
Printed in the United States of America

Order Number: 9030916-01 February 94

SPECTRUM[®], **LANVIEW**[®], **Remote LANVIEW**[®], and **HubSTACK**[™] are trademarks of Cabletron Systems, Inc.

IBM is a registered trademark of International Business Machines Corporation.

i960 is a registered trademark of Intel Corporation.

DEC, **VT200**, and **VT300** are trademarks of Digital Equipment Corporation.

Ethernet is a trademark of Xerox Corporation.

CompuServe is a registered trademark of CompuServe, Inc.

Windows is a registered trademark of Microsoft Corporation.

Printed On



Recycled Paper

NOTICE

FCC NOTICE

This device complies with Part 15 of the FCC rules. Operation is subject to the following two conditions: (1) this device may not cause harmful interference, and (2) this device must accept any interference received, including interference that may cause undesired operation.

NOTE: This equipment has been tested and found to comply with the limits for a Class A digital device, pursuant to Part 15 of the FCC rules. These limits are designed to provide reasonable protection against harmful interference when the equipment is operated in a commercial environment. This equipment uses, generates, and can radiate radio frequency energy and if not installed in accordance with the operator's manual, may cause harmful interference to radio communications. Operation of this equipment in a residential area is likely to cause interference in which case the user will be required to correct the interference at his own expense.

WARNING: Changes or modifications made to this device which are not expressly approved by the party responsible for compliance could void the user's authority to operate the equipment.

DOC NOTICE

This digital apparatus does not exceed the Class A limits for radio noise emissions from digital apparatus set out in the Radio Interference Regulations of the Canadian Department of Communications.

Le présent appareil numérique n'émet pas de bruits radioélectriques dépassant les limites applicables aux appareils numériques de la class A prescrites dans le Règlement sur le brouillage radioélectrique édicté par le ministère des Communications du Canada.

**CABLETRON SYSTEMS, INC.
PROGRAM LICENSE AGREEMENT**

IMPORTANT: Before utilizing this product, carefully read this License Agreement.

This document is an agreement between you, the end user, and Cabletron Systems, Inc. (“Cabletron”) that sets forth your rights and obligations with respect to the Cabletron software program (the “Program”) contained in this package. The Program may be contained in firmware, chips or other media. **BY UTILIZING THE ENCLOSED PRODUCT, YOU ARE AGREEING TO BECOME BOUND BY THE TERMS OF THIS AGREEMENT, WHICH INCLUDES THE LICENSE AND THE LIMITATION OF WARRANTY AND DISCLAIMER OF LIABILITY. IF YOU DO NOT AGREE TO THE TERMS OF THIS AGREEMENT, PROMPTLY RETURN THE UNUSED PRODUCT TO THE PLACE OF PURCHASE FOR A FULL REFUND.**

CABLETRON SOFTWARE PROGRAM LICENSE

1. **LICENSE.** You have the right to use only the one (1) copy of the Program provided in this package subject to the terms and conditions of this License Agreement.

You may not copy, reproduce or transmit any part of the Program except as permitted by the Copyright Act of the United States or as authorized in writing by Cabletron.

2. **OTHER RESTRICTIONS.** You may not reverse engineer, decompile, or disassemble the Program.
3. **APPLICABLE LAW.** This License Agreement shall be interpreted and governed under the laws and in the state and federal courts of New Hampshire. You accept the personal jurisdiction and venue of the New Hampshire courts.

NOTICE

EXCLUSION OF WARRANTY AND DISCLAIMER OF LIABILITY

1. **EXCLUSION OF WARRANTY.** Except as may be specifically provided by Cabletron in writing, Cabletron makes no warranty, expressed or implied, concerning the Program (including Its documentation and media).

CABLETRON DISCLAIMS ALL WARRANTIES, OTHER THAN THOSE SUPPLIED TO YOU BY CABLETRON IN WRITING, EITHER EXPRESS OR IMPLIED, INCLUDING BUT NOT LIMITED TO IMPLIED WARRANTIES OF MERCHANTABILITY AND FITNESS FOR A PARTICULAR PURPOSE, WITH RESPECT TO THE PROGRAM, THE ACCOMPANYING WRITTEN MATERIALS, AND ANY ACCOMPANYING HARDWARE.

2. **NO LIABILITY FOR CONSEQUENTIAL DAMAGES.** IN NO EVENT SHALL CABLETRON OR ITS SUPPLIERS BE LIABLE FOR ANY DAMAGES WHATSOEVER (INCLUDING, WITHOUT LIMITATION, DAMAGES FOR LOSS OF BUSINESS, PROFITS, BUSINESS INTERRUPTION, LOSS OF BUSINESS INFORMATION, SPECIAL, INCIDENTAL, CONSEQUENTIAL, OR RELIANCE DAMAGES, OR OTHER LOSS) ARISING OUT OF THE USE OR INABILITY TO USE THIS CABLETRON PRODUCT, EVEN IF CABLETRON HAS BEEN ADVISED OF THE POSSIBILITY OF SUCH DAMAGES. BECAUSE SOME STATES DO NOT ALLOW THE EXCLUSION OR LIMITATION OF LIABILITY FOR CONSEQUENTIAL OR INCIDENTAL DAMAGES, OR ON THE DURATION OR LIMITATION OF IMPLIED WARRANTIES IN SOME INSTANCES THE ABOVE LIMITATIONS AND EXCLUSIONS MAY NOT APPLY TO YOU.

UNITED STATES GOVERNMENT RESTRICTED RIGHTS

The enclosed product (a) was developed solely at private expense; (b) contains "restricted computer software" submitted with restricted rights in accordance with Section 52227-19 (a) through (d) of the Commercial Computer Software - Restricted Rights Clause and its successors, and (c) in all respects is proprietary data belonging to Cabletron and/or its suppliers.

For Department of Defense units, the product is licensed with "Restricted Rights" as defined in the DoD Supplement to the Federal Acquisition Regulations, Section 52.227-7013 (c) (1) (ii) and its successors, and use, duplication, disclosure by the Government is subject to restrictions as set forth in subparagraph (c) (1) (ii) of the Rights in Technical Data and Computer Software clause at 252.227-7013. Cabletron Systems, Inc., 35 Industrial Way, Rochester, New Hampshire 03867

TABLE OF CONTENTS

APPENDIX A TABLE OF CONTENTS v

CHAPTER 1 INTRODUCTION

1.1	USING THIS MANUAL	1-1
1.2	GETTING HELP	1-2
1.3	SEHI OVERVIEW	1-2
1.4	SEHI FEATURES.....	1-3
1.5	STACKABLE CAPABILITIES.....	1-4
1.6	REMOTE NETWORK MANAGEMENT CAPABILITIES	1-4
1.7	OPTIONAL FEATURES	1-5
1.8	RELATED MANUALS	1-6

CHAPTER 2 INSTALLATION REQUIREMENTS/SPECIFICATIONS

2.1	CABLE SPECIFICATIONS.....	2-1
2.1.1	HubSTACK Interconnect Cable Requirements.....	2-1
2.1.2	UTP and STP Cable Specifications for the Network Ports and EPIM-T Module.....	2-2
2.1.3	Multimode Fiber Optic Cable Specifications for the EPIM-F1 and EPIM-F2 Modules	2-4
2.1.4	Single Mode Fiber Optic Cable Specifications for the EPIM-F3 Module	2-5
2.1.5	Thin-Net Network Requirements for the EPIM-C Mod- ule	2-6
2.1.6	AUI Cable Requirements for the EPIM-A and EPIM-X Modules.....	2-7
2.2	NETWORK PORT SPECIFICATIONS	2-7
2.2.1	SEHI-22 and SEHI-24 Network Port Specifications...	2-8
2.2.2	SEHI-32 and SEHI-34 Network Port Specifications...	2-8
2.3	EPIM SPECIFICATIONS	2-10
2.3.1	EPIM-T	2-10
2.3.2	EPIM-F1 and EPIM-F2	2-11
2.3.3	EPIM-F3	2-12
2.3.4	EPIM-C	2-14
2.3.5	EPIM-A and EPIM-X (AUI Port).....	2-15
2.4	COM PORT REQUIREMENTS	2-16
2.5	TRANSCEIVER REQUIREMENTS	2-16

CONTENTS

2.6	OPERATING SPECIFICATIONS	2-17
CHAPTER 3 INSTALLATION		
3.1	UNPACKING THE SEHI	3-1
3.2	INSTALLING THE SEHI	3-1
3.2.1	Stacking the SEHI.....	3-2
3.2.2	Attaching the Strain Relief Bracket.....	3-4
3.2.3	Rack Mounting the SEHI.....	3-5
3.2.4	Wall Mounting the SEHI	3-6
3.2.5	Free-Standing Installation.....	3-7
3.3	CONNECTING THE SEHI TO THE POWER SOURCE.....	3-8
CHAPTER 4 CONNECTING TO THE NETWORK		
4.1	CONNECTING THE SEHI TO THE NETWORK.....	4-1
4.1.1	Connecting to Network Ports, SEHI-22 and SEHI-24	4-1
4.1.2	Connecting to Network Ports, SEHI-32 and SEHI-34	4-3
4.1.3	Connecting a UTP Segment to an EPIM-T	4-4
4.1.4	Connecting a Fiber Optic Link Segment to an EPIM-F1, EPIM-F2, or EPIM-F34-5	
4.1.5	Connecting a Thin-Net Segment to an EPIM-C	4-8
4.1.6	Connecting an AUI Cable to an EPIM-A	4-10
4.1.7	Connecting an AUI Cable to an EPIM-X.....	4-11
4.2	FINISHING THE INSTALLATION.....	4-12
CHAPTER 5 TROUBLESHOOTING		
5.1	INSTALLATION CHECK-OUT	5-1
5.2	USING LANVIEW.....	5-2
5.3	USING THE RESET BUTTON	5-4
CHAPTER 6 LOCAL MANAGEMENT		
6.1	MANAGEMENT TERMINAL REQUIREMENTS	6-2
6.1.1	Console Cable Configuration	6-3
6.1.2	Management Terminal Setup Parameters.....	6-4
6.2	ACCESSING LOCAL MANAGEMENT	6-5
6.3	USING THE LOCAL MANAGEMENT SCREENS.....	6-7
6.3.1	The Community Name Table Screen.....	6-7
6.3.2	The Configuration Screen	6-10
6.3.3	The Trap Table Screen	6-14
6.3.4	The SNMP Tools Screen.....	6-16
6.3.5	The Device Statistics Screen.....	6-22

APPENDIX B TWISTED PAIR WIRING TABLES A-1

CHAPTER 1

INTRODUCTION

Welcome to the Cabletron Systems **SEHI-22, SEHI-24, SEHI-32, and SEHI-34 10BASE-T Intelligent Stackable Hub User's Guide**. This manual explains installation instructions and provides reference information for the SEHI-22, 24, 32, and 34.

***Note:** The term SEHI (Stackable Ethernet Hub with Intelligence) is used throughout this manual when describing features and functions that are common to the SEHI-22, 24, 32, and 34.*

1.1 USING THIS MANUAL

Read through this manual to gain an understanding of the features and capabilities of the SEHI. A general knowledge of Ethernet and IEEE 802.3 type data communications networks and their physical layer components will be helpful when installing the SEHI.

Chapter 1, **Introduction**, outlines the contents of this manual, briefly describes SEHI features, and concludes with a list of related manuals.

Chapter 2, **Installation Requirements/Specifications**, describes installation requirements, network guidelines, and SEHI operating specifications.

Chapter 3, **Installation**, contains instructions for installing your SEHI as a stackable or stand-alone hub.

Chapter 4, **Connecting to the Network**, explains how to connect the SEHI to the network using the various media types.

Chapter 5, **Troubleshooting**, describes how to use the LANVIEW LEDs to troubleshoot network problems.

Chapter 6, **Local Management**, describes how to use SEHI Local Management screens and the available commands.

Appendix A, **Twisted Pair Wiring Tables**, lists Punch Down Block pinouts.

INTRODUCTION

1.2 GETTING HELP

If you need additional support related to the Cabletron Systems SEHI, or if you have any questions, comments, or suggestions concerning this manual, contact Cabletron Systems Technical Support:

- By phone (603) 332-9400
Monday-Friday; 8am - 8pm EST
- By CompuServe® GO CTRON from any ! prompt
- By Internet mail support@ctron.com
- By FTP ctron.com (134.141.197.25)
Login: *anonymous*, Password: *your email address*

1.3 SEHI OVERVIEW

The 10BASE-T SEHI is an intelligent repeating hub that provides front panel ports for network connections and a rear panel HubSTACK Interconnect Bus port for stackable connections. The SEHI is designed to manage Cabletron Systems' SEH series of non-intelligent stackable hubs.

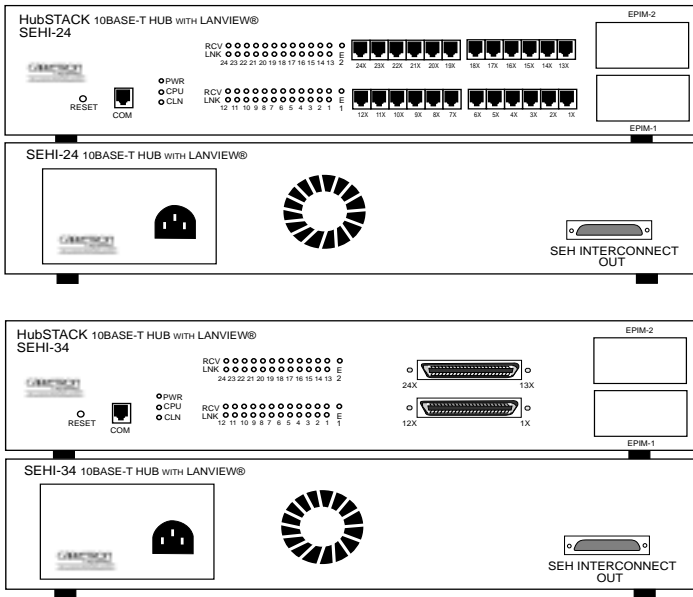

Figure 1-1. The SEHI-24 and SEHI-34

The SEHI-22/24 and SEHI-32/34 are functionally identical with the exception of the network ports:

- **SEHI-22**, 12 RJ45 network ports and one EPIM port.
- **SEHI-24**, 24 RJ45 network ports and two EPIM ports.
- **SEHI-32**, one 50 pin Champ connector, providing 12 twisted pair segments, and one EPIM port.
- **SEHI-34**, two 50 pin Champ connectors, providing 24 twisted pair segments, and two EPIM ports.

1.4 SEHI FEATURES

Repeater Functionality

The SEHI fully conforms to the IEEE 802.3 Repeater, AUI, and 10BASE-T specifications, and provides the flexibility to connect networks using IEEE 802.3, Ethernet Version 1 or Version 2 equipment. The SEHI transmits re-timed data packets, regenerates the preamble, extends fragments, and arbitrates collisions.

The SEHI automatically partitions problem segments, and reconnects repaired segments to the network. This feature minimizes the impact on network operation resulting from a problem on one segment by isolating the problem segment. Only devices on the problem segment are affected. When the problem is solved, the SEHI automatically reconnects the isolated segment to the network.

Polarity Detection and Correction

Each twisted pair port on the SEHI incorporates a Polarity Detection and Correction feature that allows the SEHI to pass data regardless of the polarity of the twisted pair segment's receive link. We do not recommend operating in this condition. If you discover this condition, remove the segment from the network and wire it correctly. This reduces the potential for problems if equipment changes are made.

Flash EEPROMs

The SEHI uses Flash EEPROMs that allow you to download new and updated firmware using Cabletron's Remote LANVIEW/Windows, version 2.3 or later or any device using BOOTP or TFTP protocols.

INTRODUCTION

LANVIEW LEDs

Cabletron Systems' LANVIEW Status Monitoring and Diagnostics System is a troubleshooting tool that helps you diagnose power failures, collisions, cable faults, and link problems. The LANVIEW LEDs are conveniently located on the SEHI's front panel.

Reset Button

The front panel Reset Button lets you reboot the SEHI and initialize the processor.

Local Management

The SEHI's Local Management lets you manage the SEHI and all its attached segments. It also provides full packet and error statistics for the entire stack, individual device, or individual port. You access Local Management by attaching a DEC VT™ 320 terminal or a PC using VT320 emulation software to the SEHI's RJ45 COM port.

1.5 STACKABLE CAPABILITIES

The SEHI intelligent hub is designed to manage Cabletron's SEH series of non-intelligent hubs. The SEHI serves as the logical "top" of the stack. It manages all SEH hubs in the stack providing full packet and error statistics for the entire stack, individual device, or individual port.

You can stack together up to four SEH non-intelligent hubs with one SEHI using Cabletron's external HubSTACK Interconnect cables. Stackable configurations let you maintain only one IEEE repeater hop while providing up to 130 Ethernet ports. You can also add or remove hubs from the stack without having to power down.

1.6 REMOTE NETWORK MANAGEMENT CAPABILITIES

You can manage the SEHI remotely by any SNMP network management system. Cabletron Systems offers the following remote management packages:

- Cabletron Systems SPECTRUM®
- Cabletron Systems Remote LANVIEW®/Windows™
- Cabletron Systems Remote LANVIEW® for SunNet™ Manager

1.7 OPTIONAL FEATURES

The following features are not included with the SEHI but can be purchased separately from Cabletron Systems.

Ethernet Port Interface Modules (EPIMs)

EPIMs let you expand your network through a variety of media. Cabletron Systems offers the EPIMs shown in Table 1-1.

Table 1-1. EPIMs

EPIM	Media Type	Connector
EPIM-A	AUI	DB15 (Female)
EPIM-C	10BASE-2 Thin Coaxial	BNC
EPIM-T	10BASE-T Unshielded Twisted Pair	RJ45
EPIM-X	Standard Transceiver	DB15 (Male)
EPIM-F1	Multimode Fiber	SMA
EPIM-F2	Multimode Fiber	ST
EPIM-F3	Single Mode Fiber	ST

HubSTACK Interconnect Cables

You need Cabletron's HubSTACK Interconnect cables to stack hubs together. Table 1-2 lists the part number and application for each cable.

Table 1-2. HubSTACK Interconnect Cables

Part Number	Description	Application
9380110	12" HubSTACK Interconnect Cable	SEH to SEH connections.
9380111	18" HubSTACK Interconnect Cable	SEHI to SEH connections.

INTRODUCTION

Daughter Board Upgrade Kit

You can upgrade the SEHI-22 and the SEHI-32 to 24 ports using the daughter board upgrade kit. The Cabletron part numbers for the upgrades are:

- SEHI-22: 24PORT-UGKT-E
- SEHI-32: 24PORT-UGKT-E 50P

Rack Mount or Wall Mount Hardware

You can install your SEHI in a 19-inch rack or mount it on a wall. Cabletron offers an accessory package that includes brackets and mounting screws. The part number for the accessory package is SEHI-ACCY-KIT.

1.8 RELATED MANUALS

Use the Cabletron Systems **SEH-22/24 and SEH-32/34 User's Guide** to supplement the procedures and other technical data provided in this manual. The procedures contained in the **SEH-22/24 and SEH-32/34 User's Guide** are referenced where appropriate, but not repeated in this manual.

CHAPTER 2

INSTALLATION REQUIREMENTS/SPECIFICATIONS

This Chapter describes cabling requirements, network guidelines, and operating specifications for the SEHI. Be sure to read this chapter before you install the SEHI. Your network must meet the requirements and conditions specified in this chapter to obtain satisfactory performance from this equipment. Failure to follow these guidelines could result in poor network performance.

2.1 CABLE SPECIFICATIONS

The SEHI network ports support both Shielded Twisted Pair (STP) or Unshielded Twisted Pair (UTP) cabling. The Ethernet Port Interface Modules (EPIMs) let you expand your network using UTP, STP, Multimode Fiber Optic, Single Mode Fiber Optic, or Thin Coaxial cabling. The rear panel Interconnect Bus port supports Cabletron Systems' HubSTACK Interconnect cables for stackable applications.

Take care in planning and preparing the cabling and connections for your network. The quality of the connections and the length of cables are critical factors in determining the reliability of your network. The following sections describe specifications for each media type.

2.1.1 HubSTACK Interconnect Cable Requirements

You stack the SEHI to modules in the stack with the SEHI HubSTACK Interconnect cable available only from Cabletron Systems. Refer to Chapter 1 for cable part numbers. The cable attaches to the SEHI's rear panel bus port.

The rear panel of the SEHI has an Interconnect Bus Out port (male connector) to stack SEH non-intelligent hubs together. You can stack as many as four SEH's together with one SEHI.

INSTALLATION REQUIREMENTS/SPECIFICATIONS

2.1.2 UTP and STP Cable Specifications for the Network Ports and EPIM-T Module

The device at the other end of the twisted pair segment must meet IEEE 802.3 10BASE-T specifications. When you connect a 10BASE-T Twisted Pair Segment to the SEHI's 10BASE-T Twisted Pair Network Ports and EPIM-T module, your network must meet the following requirements:

Length

The IEEE 802.3 10BASE-T standard requires that 10BASE-T devices transmit over a **100** meter (328 foot) link using 22-24 AWG unshielded twisted pair wire. However, cable quality largely determines maximum link length. If you use high quality, low attenuation cable, you can achieve link lengths of up to 200 meters. Cable delay limits maximum link length to 200 meters, regardless of the cable type.

Insertion Loss

The maximum insertion loss allowed for a 10BASE-T link is 11.5 dB at all frequencies between 5.0 and 10 MHz. This includes the attenuation of the cables, connectors, patch panels, and reflection losses due to impedance mismatches in the link segment.

Impedance

Cabletron Systems 10BASE-T Twisted Pair products will work on twisted pair cable with 75 to 165 ohms impedance. Unshielded twisted pair cables typically have an impedance of between 85 to 110 ohms.

Shielded twisted pair cables, such as IBM Type 1 cable, can also be used. You should remember that the impedance of IBM Type 1 cable is typically 150 ohms. This increases the signal reflection caused by the cable, but since the cable is shielded, this signal reflection has little effect on the received signal's quality due to the lack of crosstalk between the shielded cable pairs.

Jitter

Intersymbol interference and reflections can cause jitter in the bit cell timing, resulting in data errors. A 10BASE-T link must not generate more than 5.0 nsec. of jitter. If your cable meets the impedance requirements for a 10BASE-T link, jitter should not be a concern.

INSTALLATION REQUIREMENTS/SPECIFICATIONS

Delay

The maximum propagation delay of a 10BASE-T link segment must not exceed 1000 nsec. This 1000 nsec. maximum delay limits the maximum link segment length to no greater than 200 meters.

Crosstalk

Crosstalk is caused by signal coupling between the different cable pairs contained within a multi-pair cable bundle. 10BASE-T transceivers are designed so that the user does not need to be concerned about cable crosstalk, provided the cable meets all other requirements.

Noise

Noise can be caused by either crosstalk or externally induced impulses. Impulse noise may cause data errors if the impulses occur at very specific times during data transmission. Generally, the user need not be concerned about noise. If noise-related data errors are suspected, it may be necessary to either reroute the cable or eliminate the source of the impulse noise.

Temperature

Multi-pair PVC 24 AWG telephone cables typically have an attenuation of approximately 8 to 10 dB/100m at 20° C (78° F). The attenuation of PVC insulated cable varies significantly with temperature. At temperatures greater than 40° C (104° F), we strongly recommend that you use plenum-rated cables to ensure that cable attenuation remains within specification.

INSTALLATION REQUIREMENTS/SPECIFICATIONS

2.1.3 Multimode Fiber Optic Cable Specifications for the EPIM-F1 and EPIM-F2 Modules

Table 2-1 shows Multimode Fiber Optic Cable specifications for the EPIM-F1 and EPIM-F2 modules.

Table 2-1. Multimode Fiber Optic Cable Specifications

Cable Type	Attenuation	Maximum Cable Length
50/125 μm	13.0 dB or less	The maximum allowable fiber optic cable length is 2 km (2187.2 yards). However, IEEE 802.3 specifications allow for a maximum of 1 km (1093.6 yards).
62.5/125 μm	16.0 dB or less	
100/140 μm	19.0 dB or less	

Attenuation

You must test the fiber optic cable with a fiber optic attenuation test set adjusted for an 850 nm wavelength. This test verifies that the signal loss in a cable is within an acceptable level. Table 2-1 shows the attenuation for each Multimode cable type.

Fiber Optic Budget and Propagation Delay

When determining the maximum fiber optic cable length, the fiber optic budget delay and total network propagation should be calculated and taken into consideration before fiber optic cable runs are incorporated in any network design.

Fiber optic budget is the combination of the optical loss due to the fiber optic cable, in-line splices, and fiber optic connectors.

Propagation delay is the amount of time it takes data to travel from the sending device to the receiving device. Total propagation delay allowed for the entire network is 25.6 μsec , if the total propagation delay between any two nodes on the network exceeds 25.6 μsec , then bridges should be used.

2.1.4 Single Mode Fiber Optic Cable Specifications for the EPIM-F3 Module

Table 2-2 shows Single Mode Fiber Optic Cable specifications for the EPIM-F3.

Table 2-2. Single Mode Fiber Optic Cable Specifications

Cable Type	Attenuation	Maximum Cable Length
8/125-12/125 μm	10.0 dB or less	The maximum allowable fiber optic cable length is 5 km (3.1 miles) with bridges at each segment end. However, IEEE 802.3 FOIRL specifications specify a maximum of 1 km (1093.6 yards).

Attenuation

You must test the fiber optic cable with a fiber optic attenuation test set adjusted for an 1300 nm wavelength. This test verifies that the signal loss in a cable is 10.0 dB or less for any given single mode fiber optic link.

Fiber Optic Budget and Propagation Delay

Fiber optic budget is the combination of the optical loss due to the fiber optic cable, in-line splices, and fiber optic connectors. When determining the maximum fiber optic cable length, the fiber optic budget (total loss of 10.0 dB or less between stations) and total network propagation delay should be calculated and considered before fiber optic cable runs are incorporated in any network design.

Propagation delay is the amount of time it takes data to travel from the sending device to the receiving device. Total propagation delay allowed for the entire network is 25.6 μsec , if the total propagation delay between any two nodes on the network exceeds 25.6 μsec , then bridges should be used.

INSTALLATION REQUIREMENTS/SPECIFICATIONS

2.1.5 Thin-Net Network Requirements for the EPIM-C Module

When you connect a thin-net segment to the SEHI (via an EPIM-C), your network must meet the following requirements:

Cable Type

50 ohm RG-58A/U type coaxial cable must be used when making up a thin-net cable segment.

Length

The thin-net segment must be no longer than 185 meters.

Terminators

A 50 ohm terminator must be connected to the far end of each thin-net segment.

Connectors

A maximum of 29 tee-connectors may be used throughout the length of cable segment for host connections. If an excessive number of barrel connectors are used within the cable segment, such as finished wall plates with BNC feed-throughs, then a reduced number of host connections may be required. For special network design, contact Cabletron Systems Technical Support.

Grounding

For safety, ground only **one** end of a thin-net segment. Do NOT connect EPIM BNC ports to earth ground.

Warning: *Connecting a thin-net segment to earth ground at more than one point could produce dangerous ground currents.*

2.1.6 AUI Cable Requirements for the EPIM-A and EPIM-X Modules

When you connect an external network segment to the SEHI (via an EPIM-A or EPIM-X), the AUI cable must meet the following requirements:

AUI Cable

The AUI cable connecting the module to a device must be IEEE 802.3 type cable.

Length

The AUI Cable must not exceed 50 meters in length. If 28 AWG thin office drop AUI cable is used, then the maximum cable length is limited to 50 feet (15.24 meters).

Grounding

The connector shell of the EPIM-A and the EPIM-X are connected to ground.

2.2 NETWORK PORT SPECIFICATIONS

The SEHI-22 and SEHI-24 network ports are shielded RJ45 connectors that support both STP and UTP cabling. The SEHI-32 and SEHI-34 provide a 50 pin Champ style connector for network connections. The following sections provide specifications for each SEHI model.

INSTALLATION REQUIREMENTS/SPECIFICATIONS

2.2.1 SEHI-22 and SEHI-24 Network Port Specifications

The SEHI-22 and SEHI-24 provide RJ45 connections for network connections. Figure 2-1 shows the RJ45 pinouts.

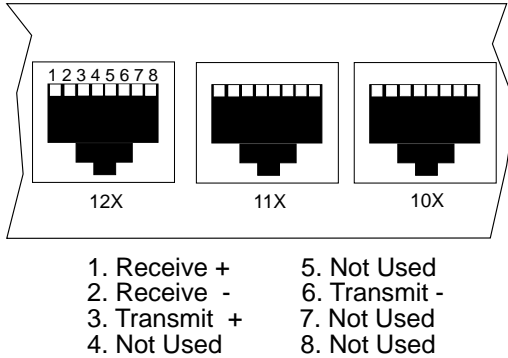

Figure 2-1. RJ45 Network Ports

2.2.2 SEHI-32 and SEHI-34 Network Port Specifications

The SEHI-32 and SEHI-34 provide 50 pin Champ connectors for network connections as shown in Figure 2-2. Table 2-3 shows the pinouts for the Champ connector.

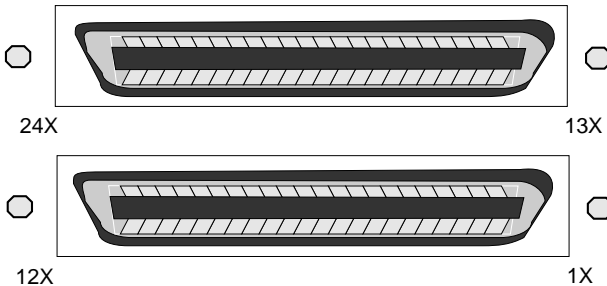

Figure 2-2. SEHI-34 Network Ports

INSTALLATION REQUIREMENTS/SPECIFICATIONS

Table 2-3. Champ Connector Pinouts

50 Pin Champ Connector

Pin	Signal	Wire Color	Pin	Signal	Wire Color
1	RX 1-	Blue/White	26	RX 1+	White/Blue
2	TX 1-	Orange/White	27	TX 1+	White/Orange
3	RX 2-	Green/White	28	RX 2+	White/Green
4	TX 2-	Brown/White	29	TX 2+	White/Brown
5	RX 3-	Gray/White	30	RX 3+	White/Gray
6	TX 3-	Blue/Red	31	TX 3+	Red/Blue
7	RX 4-	Orange/Red	32	RX 4+	Red/Orange
8	TX 4-	Green/Red	33	TX 4+	Red/Green
9	RX 5-	Brown/Red	34	RX 5+	Red/Brown
10	TX 5-	Gray/Red	35	TX 5+	Red/Gray
11	RX 6-	Blue/Black	36	RX 6+	Black/Blue
12	TX 6-	Orange/Black	37	TX 6+	Black/Orange
13	RX 7-	Green/Black	38	RX 7+	Black/Green
14	TX 7-	Brown/Black	39	TX 7+	Black/Brown
15	RX 8-	Gray/Black	40	RX 8+	Black/Gray
16	TX 8-	Blue/Yellow	41	TX 8+	Yellow/Blue
17	RX 9-	Orange/Yellow	42	RX 9+	Yellow/Orange
18	TX 9-	Green/Yellow	43	TX 9+	Yellow/Green
19	RX 10-	Brown/Yellow	44	RX 10+	Yellow/Brown
20	TX 10-	Gray/Yellow	45	TX 10+	Yellow/Gray
21	RX 11-	Blue/Violet	46	RX 11+	Violet/Blue
22	TX 11-	Orange/Violet	47	TX 11+	Violet/Orange
23	RX 12-	Green/Violet	48	RX 12+	Violet/Green
24	TX 12-	Brown/Violet	49	TX 12+	Brown
25	N/C	Gray/Violet	50	N/C	Violet/Gray

INSTALLATION REQUIREMENTS/SPECIFICATIONS

2.3 EPIM SPECIFICATIONS

EPIMs let you connect the SEHI to the main network using different media types. Cabletron Systems offers a variety of EPIMs. The following sections explain specifications for each EPIM.

2.3.1 EPIM-T

The EPIM-T is an RJ45 connector supporting UTP cabling. It has an internal Cabletron Systems TPT-T™ 10BASE-T Twisted Pair Transceiver.

The slide switch on the EPIM-T determines the cross-over status of the cable pairs. If the switch is on the X side, the pairs are internally crossed over. If the switch is on the = side, the pairs are not internally crossed over. Figure 2-3 shows the pinouts for the EPIM-T in both cross-over positions.

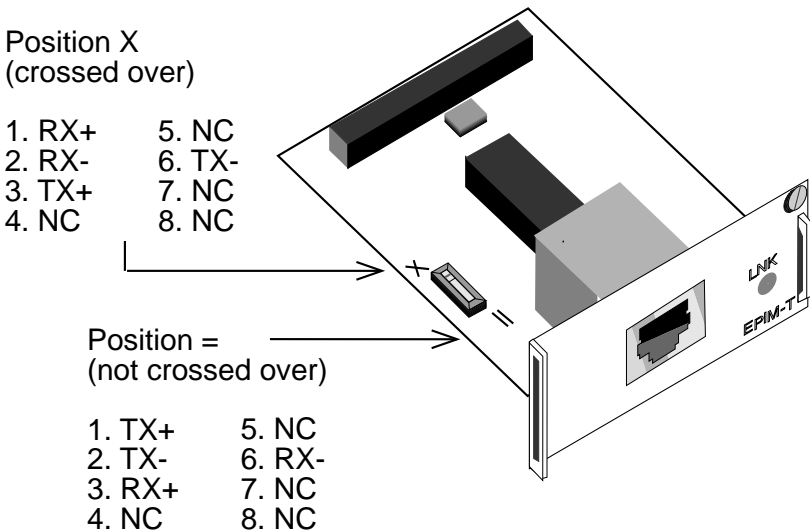

Figure 2-3. EPIM-T Pinouts

INSTALLATION REQUIREMENTS/SPECIFICATIONS

2.3.2 EPIM-F1 and EPIM-F2

The EPIM-F1 and EPIM-F2 shown in Figure 2-4 support Multimode Fiber Optic cabling. Each EPIM has an internal Cabletron Systems FOT-F™ Fiber Optic Transceiver. The EPIM-F1 is equipped with SMA Connectors and the EPIM-F2 is equipped with ST Connectors. Specifications for the EPIMs are listed below.

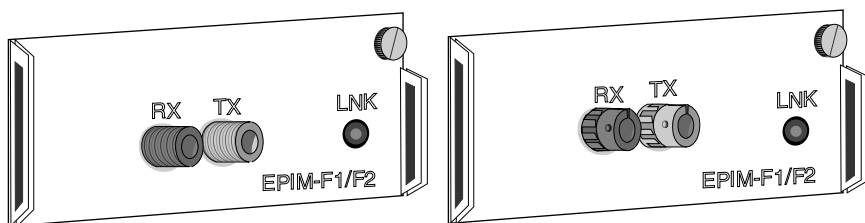

Figure 2-4. EPIM-F1 and EPIM-F2

Parameter	Typical Value	Worst Case	Worst Case Budget	Typical Budget
Receive Sensitivity:	-30.5 dBm	-28.0 dBm	—	—
Peak Input Power:	-7.6 dBm	-8.2 dBm	—	—
<u>Transmitter Power</u>				
50/125 μm fiber:	-13.0 dBm	-15.0 dBm	13.0 dB	17.5 dB
62.5/125 μm fiber:	-10.0 dBm	-12.0 dBm	16.0 dB	20.5 dB
100/140 μm fiber:	-7.0 dBm	-9.0 dBm	19.0 dB	23.5 dB
Error Rate:	Better than 10 ⁻¹⁰			

Note: The transmitter power levels and receive sensitivity levels listed are Peak Power Levels after optical overshoot. A Peak Power Meter must be used to correctly compare the values given above to those measured on any particular port. If Power Levels are being measured with an Average Power Meter, then 3 dBm must be added to the measurement to correctly compare those measured values to the values listed (i.e. -30.5 dBm peak=-33.5 dBm average).

INSTALLATION REQUIREMENTS/SPECIFICATIONS

2.3.3 EPIM-F3

The EPIM-F3 shown in Figure 2-5 supports Single Mode Fiber Optic cabling. It has an internal Cabletron Systems FOT-F™ Fiber Optic Transceiver and is equipped with ST Connectors. Specifications for the EPIM-F3 are listed below.

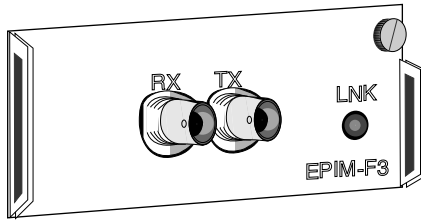
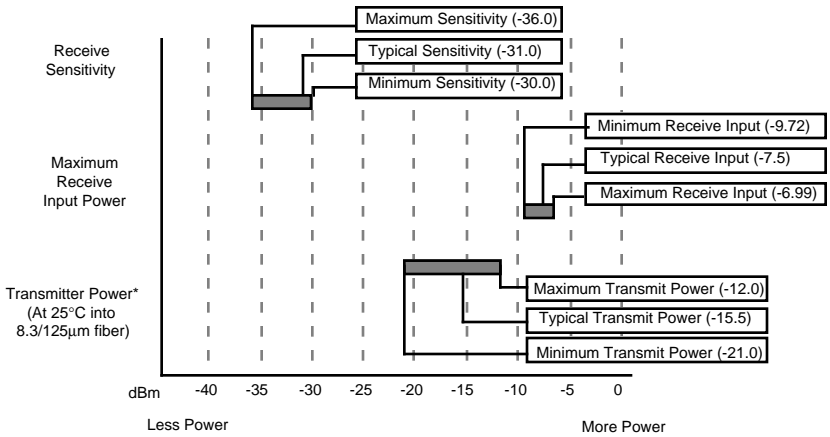

Figure 2-5. EPIM-F3

Note: *Transmitter Power decreases as temperatures rise and increases as temperatures fall. Use the Output Power Coefficient to calculate increased or decreased power output for your operating environment. For example, the typical power output at 25° C is -16.4 dBm. For a 4° C temperature increase, multiply the typical coefficient (-0.15 dBm) by four and add the result to typical output power ($4 \times -0.15 \text{ dBm} + -16.4 = -17.0$).*

INSTALLATION REQUIREMENTS/SPECIFICATIONS



* Transmit Power Coefficient (See Note Below)	Typical Power -0.15dBm/°C	Minimum Power -0.12 dBm/°C	Maximum Power -0.18 dBm/°C
---	------------------------------	-------------------------------	-------------------------------

Parameter	Typical	Minimum	Maximum
Transmitter Peak Wave Length	1300 nm	1270 nm	1330 nm
Spectral Width	60 nm	-	100 nm
Rise Time/	3.0 nsec	2.7 nsec	5.0 nsec
Fall Time	2.5 nsec	2.2 nsec	5.0 nsec
Duty Cycle	50.1%	49.6%	50.7%
Bit Error Rate:	Better than 10 ⁻¹⁰		

Note: The transmitter power levels given above are Peak Power Levels after optical overshoot. You must use a Peak Power Meter to correctly compare the values given above to those measured on any particular port. If you are measuring power levels with an Average Power Meter, add 3 dBm to the average power measurement to correctly compare the average power values measured to the values listed above (i.e. -33.5 dBm average + 3 dB = -30.5 dBm peak).

INSTALLATION REQUIREMENTS/SPECIFICATIONS

2.3.4 EPIM-C

The EPIM-C supports thin-net coaxial cabling and is equipped with an internal Cabletron Systems TMS-3™ Transceiver. You can use the TERM switch on the front of the EPIM-C to set the internal 50 Ohm terminator. This eliminates the need to connect the port to a tee-connector and terminator. Figure 2-6 shows the setting for the terminator switch.

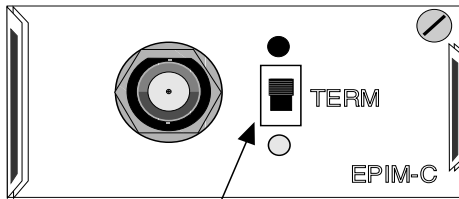

Internal Termination Switch
● = On (internally terminated)
○ = Off (need external termination)

Figure 2-6. EPIM-C

Connector Type

BNC receptacle, with gold center contact, for use with BNC type tee-connectors and RG-58 thin-net cable.

Grounding

For safety, only one end of a thin-net segment should be connected to earth ground. Connection to earth ground at more than one point on the segment may cause dangerous ground currents.

The BNC port of the Coaxial Interface Modules is not connected to earth ground.

INSTALLATION REQUIREMENTS/SPECIFICATIONS

2.3.5 EPIM-A and EPIM-X (AUI Port)

The EPIM-A is a DB15 female connector used to attach segments to an external transceiver. The EPIM-X is equipped with dual internal transceivers. It has a DB15 male connector used to attach segments to an AUI cable. Figure 2-7 shows both modules.

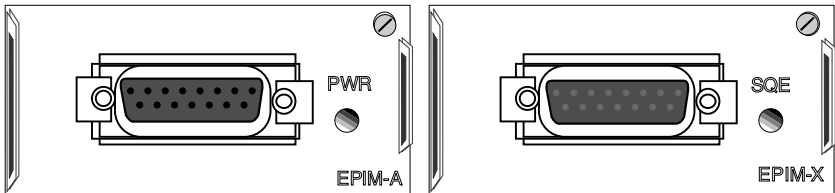

Figure 2-7. The EPIM-A and EPIM-X

DB15 Pinouts

Pin 1	Logic Ref.	9	Collision -
2	Collision +	10	Transmit -
3	Transmit	11	Logic Ref.
4	Logic Ref.	12	Receive -
5	Receive +	13	Power (+12Vdc)
6	Power Return	14	Logic Ref.
7	No Connection	15	No Connection

Connector Shell: Protective Ground

INSTALLATION REQUIREMENTS/SPECIFICATIONS

2.4 COM PORT REQUIREMENTS

The RJ45 COM port supports access to a Local Management Console. The Console port supports a Digital Equipment Corporation, VT 320™ terminal or PC emulation of the VT 320™ terminal. Figure 2-8 shows the pinouts for the RJ45 COM port.

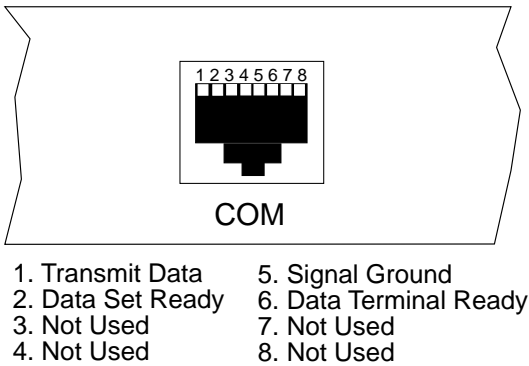

Figure 2-8. COM Port Pinouts

2.5 TRANSCEIVER REQUIREMENTS

When you connect an external network segment, via a transceiver, to the SEHI with an EPIM-A, the following requirements must be met:

- The transceiver or Ethernet Device to which the module will be connected must meet IEEE 802.3 standards, and/or Ethernet Version 1.0 or Version 2.0 standards.
- The Signal Quality Error (SQE) test function on the transceiver must be disabled if you connect it to a repeater or to an Ethernet Version 1.0 device. In addition, some Version 2.0 equipment does not support the SQE test. Devices that do not support SQE test interpret the SQE test pulse as a collision.

INSTALLATION REQUIREMENTS/SPECIFICATIONS

2.6 OPERATING SPECIFICATIONS

The operating specifications for the SEHI are described in this section. Cabletron Systems reserves the right to change these specifications at any time without notice.

GENERAL

Operating System Memory:	1.5 MB
Internal Processor:	Intel i960 operating at 16 MHz
Ethernet Controller:	National Semiconductor DP83916
Non-Volatile RAM:	32 KB with battery back-up
EPROM:	64 KB
FLASH MEMORY:	1 MB

Delay Times (Start of Packets):

Twisted Pair to EPIM- A	1.10 microseconds
Twisted Pair to Twisted Pair	1.00 microseconds
EPIM-A to Twisted Pair	1.00 microseconds

Delay Times (JAM):

Twisted Pair to EPIM-A	960 nanoseconds
------------------------	-----------------

Preamble:

Input:	Minimum of 40 bits required
Output:	64 bits min. (last 2 bits are 1, 1)

INSTALLATION REQUIREMENTS/SPECIFICATIONS

JAM Output: Collisions are propagated through the network using the JAM signal of an alternating pattern of 1's and 0's in accordance with 802.3 specifications for a repeater unit.

Fragment Extension: Packet fragments are extended to a minimum of 96 bits using the JAM [1,0].

Fault Protection: Each segment will disconnect itself from the other segments if 32 consecutive collisions occur, or if the collision detector of a segment is on for longer than approximately 110 μ s. This fault protection will reset automatically after one packet is transmitted/received onto the fault protected segment without causing a collision.

POWER SUPPLY REQUIREMENTS

***Note:** The SEHI has a universal power supply. This unit allows you to use an input power from 90 to 264 VAC, 47-63 Hz.*

The power supply has two outputs of +5 volts and +12 volts. The maximum output power is 40 watts and the minimum efficiency is 65% under all conditions of line at full load. The minimum and maximum load current from each output is shown below.

<u>Output</u>	<u>Min. Load</u>	<u>Max. Load</u>	<u>Max Power</u>
+5 Volts	0.75 Amps	4 Amps	20 Watts
+12 Volts	0.00 Amps	2 Amps	24 Watts

INSTALLATION REQUIREMENTS/SPECIFICATIONS

ENVIRONMENTAL REQUIREMENTS

Operating Temperature:	+5° to +50° C
Non-operating Temperature:	-30° to +90° C
Operating Humidity:	5 to 95% (non-condensing)

SAFETY

This unit meets the safety requirements of UL 1950, CSA C22.2 No. 950, and EN 60950; the EMI requirements of FCC Class A and EN 55022 Class A; and the EMC requirements of EN 50082-1.

Warning: *It is the responsibility of the person who sells the system to which the SEHI will be a part to ensure that the total system meets allowed limits of conducted and radiated emissions.*

PHYSICAL

Dimensions:	2.8H x 17.0W x 13.5D inches (7.2 x 43.6 x 34.6 cm)
Weight:	7 lbs.
Predicted MTBF:	SEHI-22/32: 762,931 hours SEHI-24/34: 651,695 hours

CHAPTER 3

INSTALLATION

This chapter outlines the procedure for installing the SEHI to your network as a stackable or stand-alone device. Ensure that your network meets the guidelines and requirements outlined in Chapter 2, **Installation Requirements/Specifications**, before installing the SEHI.

3.1 UNPACKING THE SEHI

Unpack the SEHI as follows:

1. Remove the shipping material covering the SEHI in the shipping box.
2. Carefully remove the SEHI from the shipping box and set it aside to prevent damage.
3. Visually inspect the SEHI. If there are any signs of damage, contact Cabletron Systems Technical Support immediately.
4. Read the SEHI Release Notes included in the shipping box.

***Note:** Cabletron Systems includes a 3-1/2" disk with the SEHI. This disk contains a backup copy of the SEHI's Flash Firmware Image File. You can download the backup image file to the SEHI if the existing image becomes corrupted.*

3.2 INSTALLING THE SEHI

You can install the SEHI to your network as a stackable or stand-alone hub. If you want to install the SEHI on a wall or a 19-inch rack, Cabletron Systems offers an accessory kit that includes Rack Mount Brackets, Wall Mount Brackets, Mounting Screws, and a Strain Relief Bracket. The accessory kit is not included with the SEHI, but you can purchase it separately from Cabletron Systems as Part Number SEHI-ACCY-KIT.

INSTALLATION

Free-standing and shelf installations must be within in reach of the network cabling and meet the requirements listed below:

- A single phase 120Vac, 15A, grounded power receptacle must be located within 7 feet of the location.
- If you use a shelving unit, it must be able to support 30 pounds of static weight for each device in the stack.
- The temperature for the selected location must be maintained between 5° and 50°C, and fluctuate less than 10°C per hour.

The following sections provide instructions for stacking the SEHI or installing it as a stand-alone device. Select one of the following subsections and perform the steps that are applicable to your installation needs.

3.2.1 Stacking the SEHI

The rear panel of the SEHI has an Interconnect Bus Out Port (male connector). You daisy chain units together using Cabletron Systems' HubSTACK Interconnect cables. Table 3-1 describes each cable.

Table 3-1. HubSTACK Interconnect Cables

Part Number	Description	Application
9380110	12" HubSTACK Interconnect Cable	SEH to SEH connections.
9380111	18" HubSTACK Interconnect Cable	SEHI to SEH connections.

To stack the SEHI together with an SEH non-intelligent hub:

1. Attach the SEHI HubSTACK Interconnect cable to the “OUT” port on the rear panel of the SEHI as shown in Figure 3-1.
2. Attach the other end of the SEHI HubSTACK Interconnect cable to the “IN” port on the rear panel of the SEH.

To stack SEH non-intelligent hubs together:

1. Attach the SEH HubSTACK Interconnect cable to the “OUT” port on the rear panel of the SEH as shown in Figure 3-1.
2. Attach the other end of the SEH HubSTACK Interconnect cable to the “IN” port on the rear panel of the SEH next in the stack.

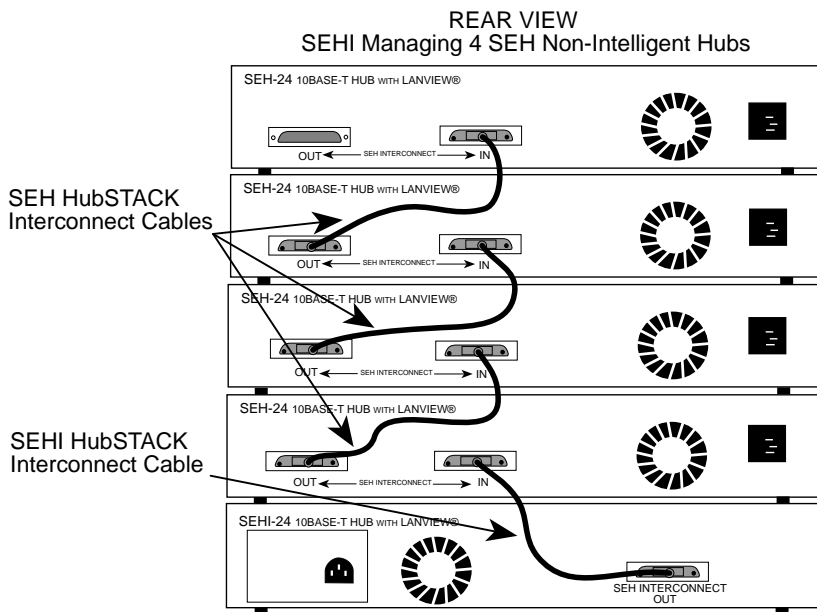

Figure 3-1. Stacking the SEHI

INSTALLATION

If you disconnect one end of a HubSTACK Interconnect cable and leave the other end attached to the hub, ensure that you disconnect the cable from the OUT port as shown in Figure 3-2. This ensures that the HubSTACK Interconnect cable is terminated properly.

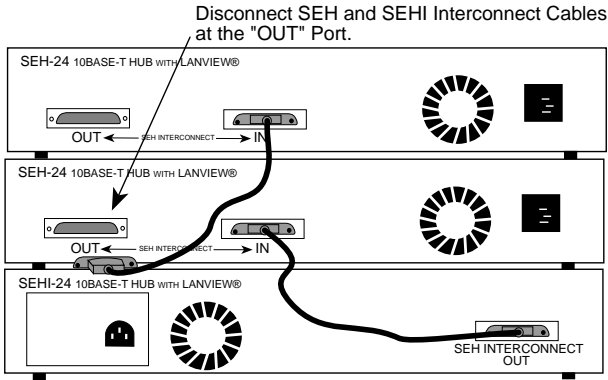

Figure 3-2. Disconnecting the HubSTACK Interconnect Cable

3.2.2 Attaching the Strain Relief Bracket

Attach the strain relief bracket to the front of the SEHI as follows:

1. Locate the strain relief bracket and four 8-32 x 3/8" screws from the SEHI-ACCY-KIT package.

Warning: Use of longer screws may cause damage to the unit or electrical shock.

2. Attach the strain relief bracket to the bottom of the SEHI as shown in Figure 3-3.

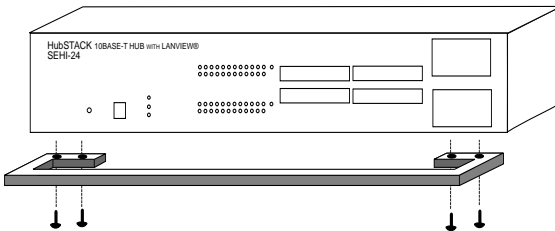

Figure 3-3. Attaching the Strain Relief

3.2.3 Rack Mounting the SEHI

Refer to Figure 3-4 and perform these steps to install the SEHI in a 19-inch rack.

1. Remove four cover screws (two from each side) located along the front edges of each side of the SEHI.
2. Using the four cover screws removed in step 1, attach the rack mounting brackets to each end of the SEHI.

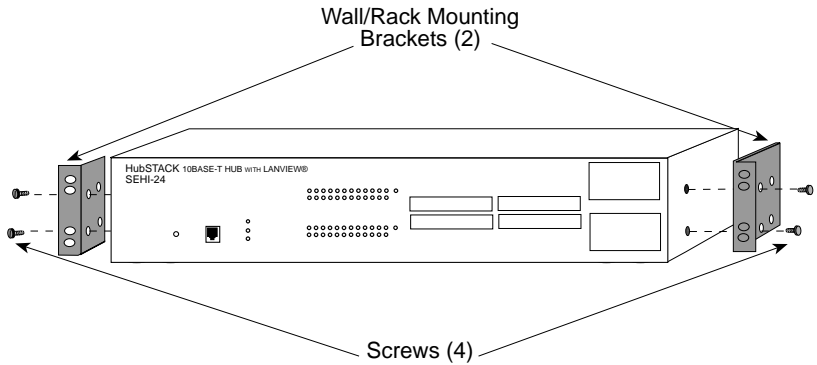

Figure 3-4. Installing the Rack Mount Brackets

3. With the mounting brackets installed, position the SEHI between the vertical frame members of the 19-inch rack and fasten it securely with the mounting screws as shown in Figure 3-5.

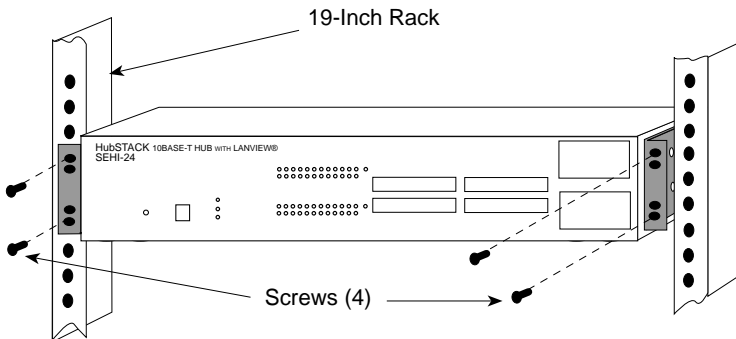

Figure 3-5. Installing the SEHI in the Rack

INSTALLATION

3.2.4 Wall Mounting the SEHI

When you wall mount the SEHI, the cable connections must face down. Refer to Figure 3-6 and perform the following steps to wall mount the SEHI.

Note: 1/4-inch Molly screw anchors for wall mounting are not included with the SEHI-ACCY-KIT package.

1. Use the supplied screws to attach the wall mounting brackets to the bottom of the SEHI as shown in Figure 3-6. There are two brackets, one for each side.

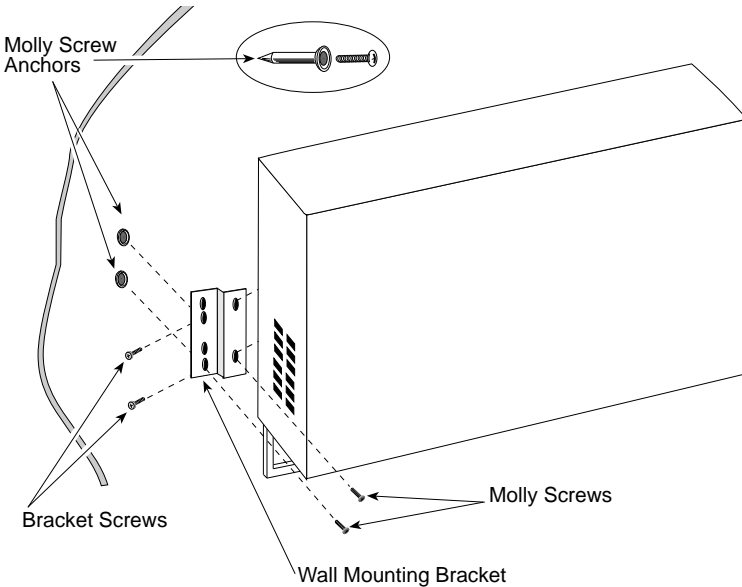

Figure 3-6. Wall Mounting the SEHI

2. Select the wall location for the SEHI within 7 feet of a power outlet.

Warning: There is a potential **SHOCK HAZARD** if there is electrical wiring within the wall that interferes with drilling for pilot holes. Select a wall location where drilling pilot holes for the Molly screws will not come in contact with electrical wiring in the wall.

3. You will need a pencil for this step. With the wall mounting brackets attached to the SEHI, position the SEHI against the wall where it will be permanently mounted with the network port facing down. Use the pencil to mark the wall location for the four pilot holes.
4. Set the SEHI aside and carefully drill four 1/4" pilot holes, one for each of the Molly screw anchors and insert the four Molly screw anchors into the holes just drilled.
5. Tighten each of the anchor screws until the anchor expands holding the anchor firmly in the wall, then remove the screws completely.
6. Position the SEHI on the wall over the anchors and reinstall the four anchor screws to attach the SEHI to the wall, as shown in Figure 3-6. Tighten the four anchor screws.

3.2.5 Free-Standing Installation

For a free-standing shelf or tabletop installation, locate the SEHI within 7 feet of its power source and with an unrestricted free surface area 21 inches wide, 18 inches deep and 6 inches high, as shown in Figure 3-7.

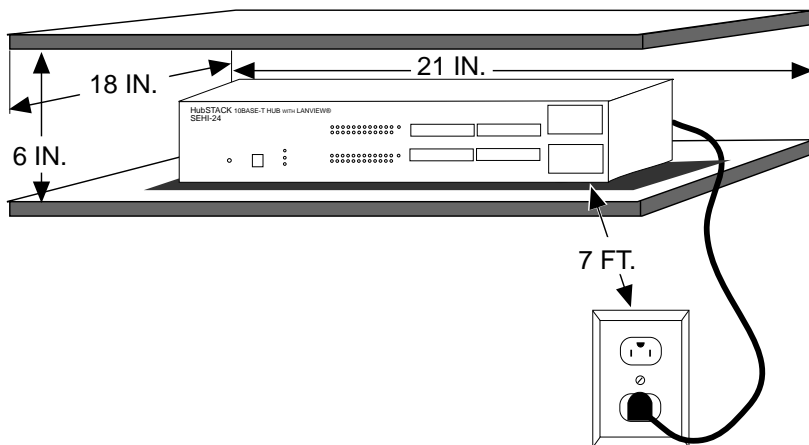

Figure 3-7. Shelf or Table-top Installation

INSTALLATION

3.3 CONNECTING THE SEHI TO THE POWER SOURCE

***Note:** The SEHI has a universal power supply. This allows you to connect the SEHI to power sources from 90 Vac to 264 Vac, 47-63 Hz.*

To connect the SEHI to the power source:

1. Plug the power cord into the back panel of the SEHI.
2. Plug the other end of the power cord into a grounded wall outlet.
3. Verify that the **PWR** LED is on, this indicates that the SEHI is receiving power. After the SEHI runs a self test, the **CPU** LED blinks green indicating normal operation. If the LED remains red, the processor is faulty.

CHAPTER 4

CONNECTING TO THE NETWORK

This chapter outlines the procedure for connecting the SEHI to your network. Ensure that your network meets the guidelines and requirements outlined in Chapter 2, **Installation Requirements/Specifications**, before installing the SEHI to your network.

4.1 CONNECTING THE SEHI TO THE NETWORK

The procedure for connecting network segments to the SEHI varies depending on the media and ports being connected. Refer to the following list and perform the procedure described in the subsections that apply to your SEHI:

- Network Ports, SEHI-22/24 4.1.1
- Network Ports, SEHI-32/34 4.1.2
- EPIM-T 4.1.3
- EPIM-F1, F2, F3 4.1.4
- EPIM-C 4.1.5
- EPIM-A 4.1.6
- EPIM-X 4.1.7

Prior to connecting the network cabling check the connectors for the proper pinouts as shown in Chapter 2.

4.1.1 Connecting to Network Ports, SEHI-22 and SEHI-24

You attach unshielded twisted pair segments to the RJ45 Network Ports on the front panel of the SEHI. Each twisted pair port on the SEHI incorporates a Polarity Detection and Correction feature. The Polarity Detection and Correction feature allows the SEHI to pass data regardless of the polarity of the twisted pair segment's receive link. Operating in this condition is not recommended and if this condition is discovered, the segment should be removed from the network and wired correctly by a technician.

CONNECTING TO THE NETWORK

To connect twisted pair segments to the SEHI:

1. Insert the RJ45 connector from each twisted pair segment into the desired network port on the SEHI. See Figure 4-1.

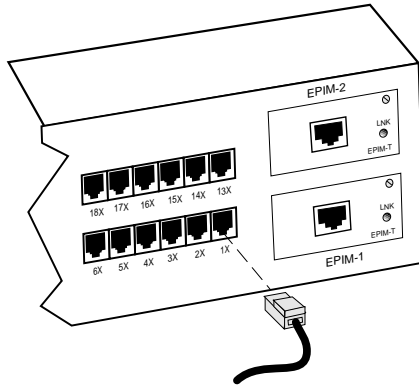

Figure 4-1. SEHI-22/24 Network Ports

2. Check that the applicable **LNK** LED for the port is on. If the LED is not on, perform each of the following steps until it is:
 - a. Check that the 10BASE-T device at the other end of the twisted pair segment is powered up.
 - b. Verify that the RJ45 connector on the twisted pair segment has the proper pinouts. Check the cable for continuity.
 - c. Check that the twisted pair connection meets dB loss and cable specifications outlined Chapter 2.

If a link still has not been established, contact Cabletron Systems Technical Support.

4.1.2 Connecting to Network Ports, SEHI-32 and SEHI-34

The SEHI-32 has a 50-pin Champ connector, while the SEHI-34 has two 50-pin Champ connectors. This configuration of the SEHI allows you to run a 50-pin feeder cable from the SEHI to a punch down block. Each Champ connector supports 12 10BASE-T, twisted pair segments.

Note: Refer to **Appendix A** for information about wiring the SEHI to a punch down block.

To connect the SEHI into an existing twisted pair wiring system:

1. Connect a 50-pin feeder cable to the Champ connector on the SEHI as shown in Figure 4-2.

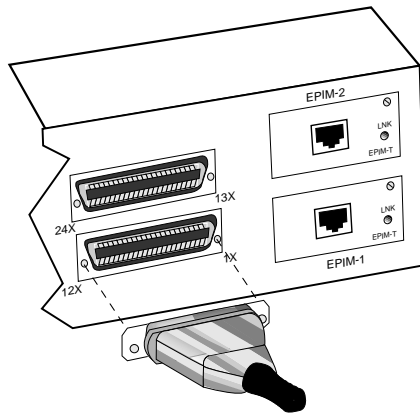

Figure 4-2. SEHI-32/34 Network Ports

2. Attach the feeder cable to the punch down block, or patch panel.

In most cases, you can connect the feeder cable directly to a Champ connector located on the punch down block. If not, you must wire the feeder cable to the punch down block using the punch down information in Appendix A.

3. At the device end of a segment, attach the segment to a 10BASE-T compliant Ethernet device.

CONNECTING TO THE NETWORK

4. Check that the link LED on the 10BASE-T Ethernet device and the applicable **LNK** LED on the SEHI are on. If the LEDs are not on, perform each of the following steps until the LEDs are on:
 - a. Check that the 10BASE-T device and the SEHI have power.
 - b. Verify the cabling between the SEHI and the 10BASE-T device.
 - c. Check the cable for continuity.

If a link has not been established, contact Cabletron Systems Technical Support.

4.1.3 Connecting a UTP Segment to an EPIM-T

Before connecting a segment to the EPIM-T, check each end of the segment to determine if the wires have been crossed-over for the proper connection. If the wires do not cross over, use the switch on the EPIM-T to internally cross over the RJ45 port. Refer to Figure 4-3 to properly set the EPIM-T cross-over switch.

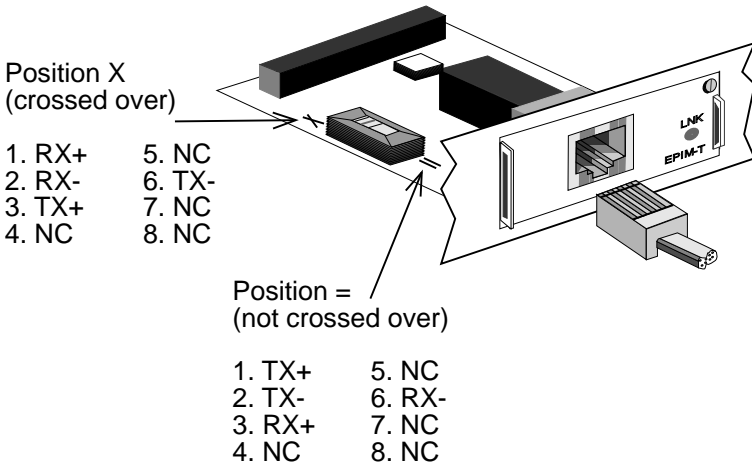

Figure 4-3. EPIM-T Cross-over Switch

To connect an EPIM-T to a Twisted Pair Segment:

1. Insert the RJ45 connector on the twisted pair segment into the RJ45 port on the EPIM. See Figure 4-3.
2. Check that the EPIM's **LNK** LED is on. If the LED is not on, perform each of the following steps until it is:
 - a. Check that the 10BASE-T device at the other end of the twisted pair segment is powered up.
 - b. Verify that the RJ45 connector on the twisted pair segment has the proper pinouts.
 - c. Check the cable for continuity.
 - d. Check that the twisted pair connection meets dB loss and cable specifications outlined in Chapter 2.
 - e. Check that the crossover switch is in the correct position.

If a link still has not been established, contact Cabletron Systems Technical Support.

4.1.4 Connecting a Fiber Optic Link Segment to an EPIM-F1, EPIM-F2, or EPIM-F3

When connecting a fiber optic link segment to an EPIM-F1, F2, or F3 keep the following in mind:

- If you are connecting a fiber optic link segment with SMA 906 connectors to an EPIM-F1 with SMA ports, ensure that half alignment sleeves are in place on each connector. A full alignment sleeve will damage the receive port. SMA 905 connectors do not need alignment sleeves.
- If you are connecting a fiber optic link segment with ST connectors to an EPIM-F2 /F3 with ST ports, keep in mind that ST connectors attach to ST ports much like BNC connectors attach to BNC ports. Insert the connector into the port with the alignment key on the connector inserted into the alignment slot on the port. The connector is then turned to lock it down.

CONNECTING TO THE NETWORK

- The physical communication link consists of two strands of fiber optic cabling: the Transmit (TX) and the Receive (RX). The Transmit strand from the applicable port on the module will be connected to the Receive port of a fiber optic Ethernet device at the other end of the segment. For example, TX of the applicable port on the module will go to RX of the other fiber optic device. The Receive strand of the applicable port on the module will be connected to the Transmit port of the fiber optic Ethernet device. For example, RX of the applicable port on the module will go to TX of the other fiber optic device.

We recommend that you label the fiber optic cable to indicate which fiber is Receive and which is Transmit. When you buy fiber optic cable from Cabletron Systems, it is labeled so that: at one end of the cable, one fiber is labeled 1, and the other fiber is labeled 2. This pattern is repeated at the other end of the cable. If you did not purchase your cable from Cabletron Systems, be sure you label your cable as described above.

Caution: Do not touch the ends of the fiber optic strands, and do not let the ends come in contact with dust, dirt, or other contaminants. Contamination of the ends can cause problems in data transmissions. If the ends become contaminated, clean them with alcohol using a soft, clean, lint free cloth.

To connect a fiber optic link segment to an EPIM-F1, EPIM-F2, or EPIM-F3:

1. Remove the protective plastic covers from the fiber optic ports on the applicable port on the module and from the ends of the connectors on each fiber strand.
2. Attach the fiber labeled 1 to the applicable receive port, labeled **RX**, on the module. See Figure 4-4.

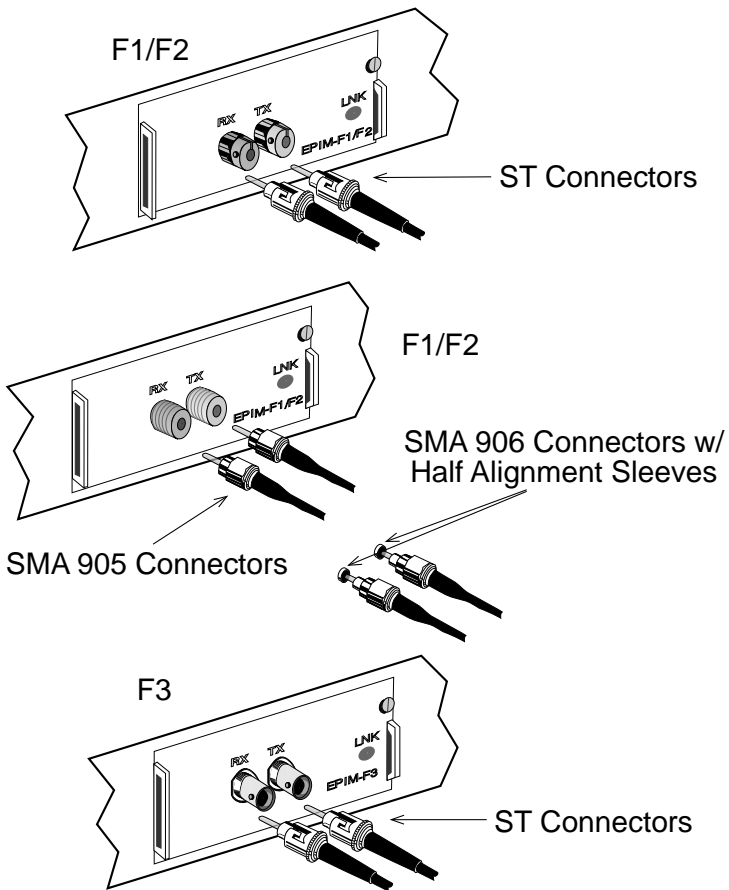

Figure 4-4. The EPIM-F1, EPIM-F2 and EPIM-F3

3. Attach the fiber labeled 2 to the applicable transmit port labeled **TX**, on the module.
4. At the other end of the fiber optic cable, attach the fiber labeled 1 to the transmit port of the device.
5. Attach the fiber labeled 2 to the receive port.

CONNECTING TO THE NETWORK

6. Check that the EPIM's **LNK** LED is on. If the LED is not on, perform the following steps until it is:
 - a. Check that the power is turned on for the device at the other end of the link.
 - b. Verify proper “cross-over” of fiber strands between the applicable port on the module and the fiber optic device at the other end of the fiber optic link segment.
 - c. Verify that the fiber connection meets the dB loss specifications outlined in Chapter 2.

If a link still has not been established, contact Cabletron Systems Technical Support.

4.1.5 Connecting a Thin-Net Segment to an EPIM-C

To connect a thin-net segment to an EPIM-C, refer to Figure 4-5 and perform the following steps:

1. Set the Internal Termination Switch to the right of the port and labeled **TERM** to:
 - The on position (•) if the thin-net segment connected directly to the port will be internally terminated at the port.
 - The off position (o) if the thin-net segment will not be terminated at the port or externally terminated.
2. If the Internal Termination switch is in the On position, connect the thin-net segment directly to the BNC port as shown in Figure 4-5.
3. If the Internal Termination switch is in the Off position:
 - a. Attach a BNC tee-connector to the BNC port on the module.
 - b. Attach the thin-net segment to one of the female connectors on the tee-connector.

CONNECTING TO THE NETWORK

Note: You must terminate each segment attached to the tee-connector. If you do not attach a segment to one of the female connections on the tee-connector, then a terminator must be placed on that connection.

- c. Attach another thin-coax segment or a terminator to the other female connector on the tee-connector.

When internal termination switch is set to off (○):

Connect BNC tee-connector to port.

Attach a terminator or terminated thin-net segment to one female connector of tee-connector.

Connect a terminated thin-net segment to other female connector of tee-connector.

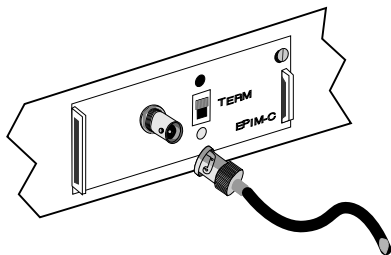

Attach thin-net segment directly to BNC connector when internal termination switch is set to on (●).

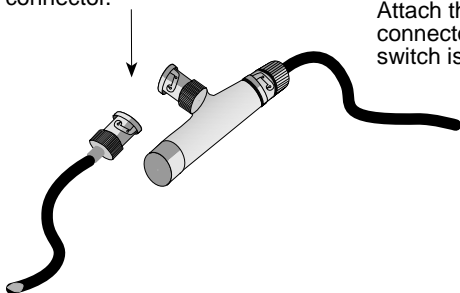

Figure 4-5. The EPIM-C

CONNECTING TO THE NETWORK

4.1.6 Connecting an AUI Cable to an EPIM-A

Caution: Ensure that the external transceiver to which the SEHI will be connected does not have the signal quality error (SQE or “heartbeat”) test function enabled. The SEHI will not operate if the transceiver has the SQE test function enabled, and the network will be unusable. Refer to the applicable transceiver manual.

To connect an EPIM-A to an external network segment:

1. Attach an external transceiver to the network segment that will be connected to the AUI port. Refer to the applicable transceiver manual.
2. Attach an AUI cable, no longer than 50 meters in length, to the transceiver connected to the network in step 1.
3. Connect the AUI cable to the AUI port located on the EPIM-A. See Figure 4-6.
4. Lock the AUI connector into place using the connector slide latch.

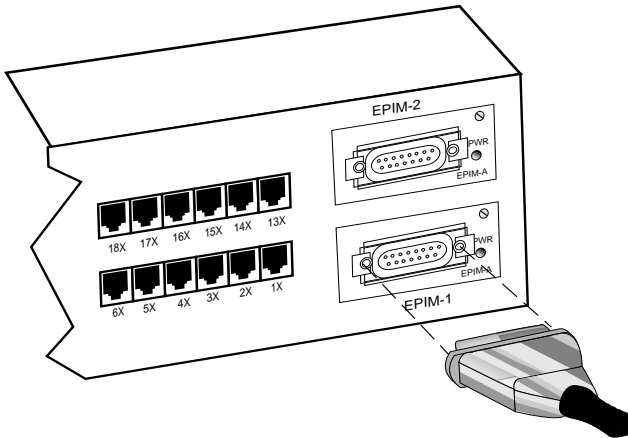

Figure 4-6. The EPIM-A

5. Check that the **PWR** LED on the EPIM-A is on. If the LED is not on, contact Cabletron Systems Technical Support.
6. If the **PWR** LED is on with the AUI cable disconnected, continue with the following checks:
 - a. Check the AUI connections for proper pinouts. The pinouts for the transceiver connection are listed in Chapter 2.
 - b. Check the cable for continuity.
 - c. Reconnect the AUI cable to the SEHI and the device.

If the LED is still not on after reconnecting the segment, contact Cabletron Systems Technical Support.

4.1.7 Connecting an AUI Cable to an EPIM-X

Caution: *The signal quality error (SQE) switch remains in the OFF position for most network connections. However, some Data Terminal Equipment (DTE) requires SQE. Refer to your DTE manual for SQE requirement information.*

To connect an EPIM-X to a device not requiring SQE:

1. Check that the **SQE** LED on the EPIM-X is off. If the **SQE** LED is on, check the position of the SQE switch.

Note: *If the SQE light remains on, even though the SQE switch is in the OFF position, contact Cabletron Technical Support.*

2. Attach one end of an AUI cable, no longer than 50 meters in length, to the port located on the EPIM-X (Figure 4-7) and the other end to the intended node.

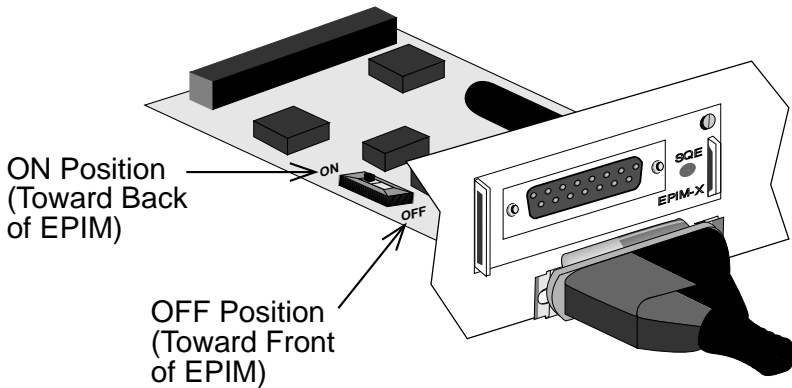

Figure 4-7. The EPIM-X

4.2 FINISHING THE INSTALLATION

The SEHI is now ready for operation. Before placing the network into service, test the installation thoroughly, making sure that you can address all stations and that the SEHI and all stations are indicating normal operation. Ensure that the networking software is configured properly to match the installed network. If you encounter errors or abnormal operation, proceed to Chapter 5, **Troubleshooting**.

CHAPTER 5

TROUBLESHOOTING

This chapter contains instructions for using LANVIEW LEDs to troubleshoot physical layer network problems. It also describes how to reset the SEHI.

5.1 INSTALLATION CHECK-OUT

After you connect the SEHI to the network, verify that packets pass between all Ethernet devices connected to the SEHI and any other devices connected to the network. If you encounter difficulty with any of the attached devices, check the link as follows:

1. Check that the **LNK** LED, if applicable, for the port is on. If the LED is not on:
 - a. Check that the 10BASE-T device at the other end of the twisted pair segment is powered up.
 - b. Verify that the connector on the twisted pair segment has the proper pinouts. Refer to Chapter 2 for the pin assignments for twisted pair connectors.

For EPIM-F1/EPIM-F2 check that the TX and RX fibers are properly connected.

- c. Check the cable for continuity. A variety of tools are available for this test, depending on the media you are using.
- d. Check that the twisted pair segments meet cable specifications for dB loss described in Chapter 2.

TROUBLESHOOTING

2. If the remote station is ready and the **LNK** LED is on, but no data passes through the port, one of two conditions may exist:
 - Network management has disabled the port.
 - The port is segmented either because the collision detector was on for more than 110 μ sec. or the SEHI detected more than 32 consecutive collisions on the attached segment. The affected port remains segmented until a good packet is transmitted/received without collisions.

If the **LNK** LED is still not on, contact Cabletron Systems Technical Support.

5.2 USING LANVIEW

The SEHI incorporates the Cabletron Systems LANVIEW Status Monitoring and Diagnostics System. LANVIEW LEDs can help diagnose problems such as a power failure or a cable fault. The SEHI includes the following LANVIEW LEDs:

- **PWR**, for power status
- **CPU**, for board status
- **RCV** (Receive), **LNK** (Link), and **CLN** (Collision) for Ethernet status.

Figure 5-1 provides a quick reference chart of LED locations and definitions. This chapter also includes a detailed description of each LED.

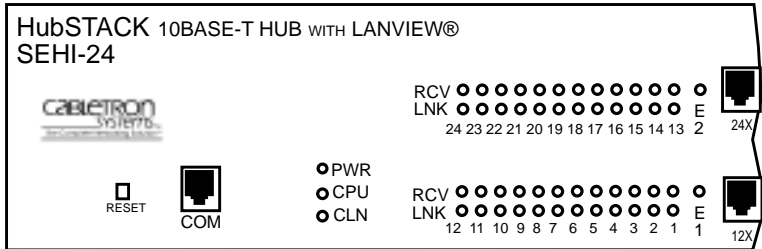

LED NAME	LED COLOR	DEFINITION
PWR (Power)	Off Green (Solid)	No Power Power
CPU (Central Processing Unit)	Off Green (Flashing) Green (Blinking) Red (Solid)	CPU in BOOT Process CPU Initializing CPU Functioning CPU Not Functioning
CLN (Collision)	Red	Collision
RCV (Receive)	Yellow (Flashing) Off	SEHI is Receiving Data No Activity
LNK (Link)	Green Off	Link Established No Link

Note: “Flashing” indicates an irregular LED pulse.
 “Blinking” indicates a steady LED pulse.

Figure 5-1. LANVIEW LEDs

PWR

When this green LED is on it indicates that the SEHI is receiving power. If this LED is not on, it indicates a loss of input power. Check the input power source (circuit breaker, fuse, etc.). If the proper source power is present, the problem could be with the SEHI.

CPU

This LED alternates from red to green to during power up. After the boot is complete, the LED blinks green. A blinking green LED indicates normal operation. A red LED indicates a faulty processor.

TROUBLESHOOTING

CLN

This red LED indicates that a collision has occurred on one of the ports.

RCV

When this yellow LED flashes, it indicates that the SEHI is receiving data packets from the associated port segment. Each SEHI port has a corresponding RCV LED:

- Network Ports: RCV LEDs **1-24**
- EPIM-1: RCV LED **E1**
- EPIM-2: RCV LED **E2**

LNK

When a green LNK LED is on, it indicates an established link between the associated twisted pair segment and the 10BASE-T device at the other end of the segment. LNK LEDs will remain on as long as a link is maintained. Each SEHI Network Port (ports **1-24**) has a corresponding LNK LED.

5.3 USING THE RESET BUTTON

The SEHI incorporates a recessed Reset button. See Figure 5-1. This Reset button initializes the SEHI processor. This button does NOT initialize Non-Volatile Random Access Memory (NVRAM), the non-volatile random access memory where the SEHI stores network management parameters.

To use the Reset button, use a pen or pencil to press the button in. When this is done, the SEHI initializes itself.

CHAPTER 6

LOCAL MANAGEMENT

This chapter explains how to set up a management terminal to access the SEHI's Local Management. It also explains how to use the Local Management screens and commands.

Local Management supplies the tools to manage the SEHI and all of its attached segments. You can:

- assign an IP address and subnet mask
- select a default gateway
- control access to the SEHI through the community names established in the Community Name Table
- designate which Network Management Workstations receive trap messages from the device
- navigate through the Management Information Base (MIB) and manage the objects within it from a remote location. Given the appropriate security level, the MIB is accessible from the SEHI through SNMP Tools.

Local Management also lets you manage each of the non-intelligent stackable hubs attached to the SEHI. You can also use the Statistics screen to view error, collision, and traffic statistics for the entire stack, individual module, or individual port.

LOCAL MANAGEMENT

6.1 MANAGEMENT TERMINAL REQUIREMENTS

To access Local Management you need one of the following:

- a Digital Equipment Corporation VT series terminal
- a VT type terminal running emulation programs for the Digital Equipment Corporation VT series
- an IBM or compatible PC running a VT series emulation software package.

You also need a console cable to attach the management terminal to the SEHI. The console cable is not included with the SEHI, but you can purchase it separately from Cabletron as part number SEHI-ACCY-KIT.

The SEHI-ACCY-KIT package provides an RJ45 Cable Kit that includes the following:

- UTP console cable with RJ45 connectors on each end
- Adapters for DB9 or DB25 connections
- Instruction Sheet

The following sections explain how to attach the console cable and set up the management terminal. Refer to the RJ45 Cable Kit Instruction Sheet for adapter pinouts and additional information.

6.1.1 Console Cable Configuration

Use the RJ45 Cable Kit provided with the SEHI-ACCY-KIT package to attach the management terminal to the SEHI's COM port as shown in Figure 6-1.

Connect the console cable to the SEHI as follows:

1. Attach the male RJ45 connector to the COM port of the SEHI.
2. Attach the female end (25-pin or 9-pin, as applicable) to the COMM port on the terminal.

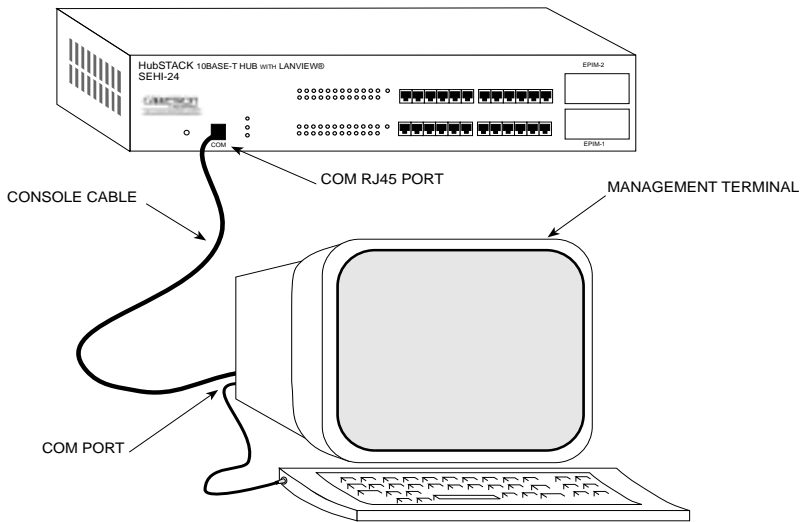

Figure 6-1. Management Terminal Connection

LOCAL MANAGEMENT

6.1.2 Management Terminal Setup Parameters

Table 6-1 lists the setup parameters for the local management terminal. If your terminal is a Digital Equipment Corporation VT320™ terminal, press **F3** to access the Setup Directory. If you have a terminal emulation of the VT320™, refer to your equipment user manual for setup procedures.

Table 6-1. Terminal Setup Parameters

Menu	Function	Selection
Display Setup:	Columns	80 Columns
	Controls	Interpret Controls
	Auto Wrap	No Auto Wrap
	Test Cursor	Cursor
General Setup:	Mode	7 Bit Control
	Cursor Keys	Normal Cursor Keys
Communications Setup:	Transmit	Transmit = 9600
	Receive	Receive = Transmit
	XOFF	any option
	Bits, Parity	8 Bits, No Parity
	Stop Bit	1 Stop Bit
	Local Echo	No Local Echo
	Port	DEC-423, Data Leads Only
	Transmit	any option
	Auto Answerback	No Auto Answerback
Keyboard Setup:	Auto Repeat	any option
	Keyclick	any option
	Margin Bell	Margin Bell
	Warning Bell	Warning Bell
	Auto Answerback	No Auto Answerback

LOCAL MANAGEMENT

3. Press the **Return** key.

- If your password entry is invalid, the cursor returns to the beginning of the password entry field.
- If your password is valid, the associated access privilege appears briefly, then the SEHI Local Management Feature Selection screen shown in Figure 6-3 appears.

Note: *If you do not use the terminal keyboard for 15 minutes, your Local Management session ends and the screen defaults to the Password screen.*

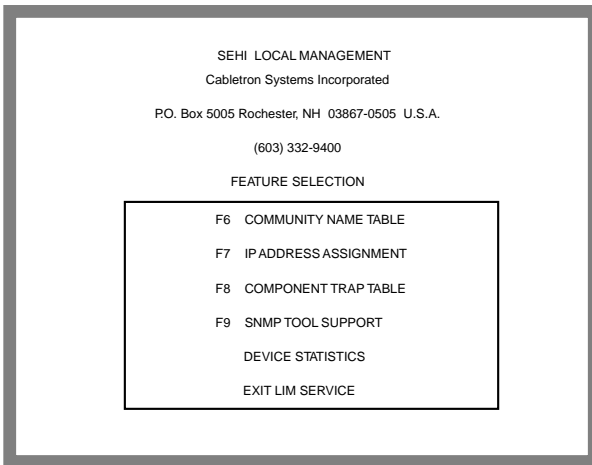

Figure 6-3. Feature Selection Screen

6.3 USING THE LOCAL MANAGEMENT SCREENS

The Feature Selection screen is the main menu screen for SEHI Local Management. You can select five screen options in the Feature Selection screen: Community Name Table, IP Address Assignment, Component Trap Table, SNMP Tool Support, and Device Statistics. Use the arrow keys to highlight an option, then press **Return** (or press the corresponding **Function Key**). The selected screen appears.

To exit your Local Management session, use the arrow keys to highlight the EXIT LIM SERVICE command, then press **Return**.

6.3.1 The Community Name Table Screen

To access the Community Name Table screen from the Feature Selection screen, use the arrow keys to highlight the **Community Name Table** option, then press **Return** or **F6**. The Community Name Table screen shown in Figure 6-4 appears.

SEHI LOCAL MANAGEMENT				
Cabletron SEHI Revision X.XX.XX				
COMMUNITY NAME TABLE				
COMMUNITY NAME		ACCESS		
PUBLIC		BASIC-READ		
PUBLIC		READ-ONLY		
PUBLIC		READ-WRITE		
PUBLIC		SUPER-USER		
SAVE	IP TABLE	TRAP TABLE	SNMP TOOLS	RETURN
F6	F7	F8	F9	

Figure 6-4. Community Name Table Screen

LOCAL MANAGEMENT

The Community Name Table option lets you set community names. Community names are passwords to Local Management and they are agents of security control to your SEHI. You control SEHI access by establishing up to four different levels of security authorization: Basic-Read, Read-Only, Read-Write, and Super-User.

If you have Super-User access, you can change the existing passwords by changing the community names. Only the community name assigned Super-User access has full management privileges.

The following sections explain each field on the Community Name Table screen and instructions on how to change them.

Community Name

Displays the user-defined name through which a user can access Local Management for the SEHI. Any community name assigned here acts as a password to Local Management.

Access

Indicates the access status accorded each community name. Possible conditions are:

Basic-Read	This allows read only access to Local Management, but excludes read privileges to the Component Trap screen.
Read-Only	This allows read only access to Local Management, but excludes access to security protected fields of the upper levels of authorization (Read-Write or Super-User).
Read-Write	This allows you to read and write to Local Management fields, Excluding IP Address, Subnet Mask, and Community Names.
Super-User	This access privilege gives the user read and write access to Local Management. Super-User allows read and write access to all modifiable parameters including: Community Names, IP Addresses, Traps, and SNMP Objects.

Editing the Community Name Field

The password that you use to access Local Management at the Password screen must have Super-User privileges for your edits to take effect. If you enter a password with Basic-Read, Read-Only, or Read-Write privileges, Local Management displays the message "AUTHORIZATION PROHIBITS ACCESS", and does not include editing capabilities.

To edit the Community Name field:

1. Use the arrow keys to highlight the **Community Name** field adjacent to the access level of your choice.
2. Enter the community name, up to 32 characters in length, into the field.
3. Press the **Return** key.
4. Repeat steps 1-3 for editing any of the other community names.
5. Use the arrow keys to highlight the SAVE command at the bottom of the screen, then press the **Return** key or F6. The "SAVED OK" message appears indicating that your edits have been saved to memory.

Please note that the first time you try to exit the screen without saving your changes, you will get a "NOT SAVED?" message. If you proceed to exit without saving, you will lose your edits.

6. To exit the screen, press the appropriate Function key or use the arrow keys to highlight the RETURN command.
7. Press the **Return** key. The Feature Selection screen appears.

6.3.2 The Configuration Screen

To access the Configuration screen from the Feature Selection screen, use the arrow keys to highlight the **IP Address Assignment** option then press the **Return** key or **F7**. The Configuration screen shown in Figure 6-5 appears.

```
SEHI LOCAL MANAGEMENT
Cabletron SEHI Revision X.XX.XX

CONFIGURATION

I/F      IPAddress      SubNET Mask      MAC Address
-----
1        000.000.000.000  000.000.000.000  00-00-1d-05-dc-36

Default Gateway: 0.0.0.0
Serial Port 1 Application: CONSOLE  Baud Rate: 9600 --ACTIVE--
Port Enable Override: OVERRIDE DISABLED

SAVE      COMMUNITY NAMES  TRAP TABLE  SNMP TOOLS  RETURN
F6        F7                F8            F9
```

Figure 6-5. Configuration Screen

The SEHI Configuration screen lets you assign the IP Address, Subnet Mask, and Default Gateway. You can also use the Port Enable Override option to enable all device ports in the stack. This option overrides the Port Disable setting in the Statistics screen.

The following sections explain each field on the Configuration screen and instructions on how to change them.

I/F

Gives the number of the interface corresponding to the channels over which packets with that IP Address are passing. On the SEHI, this value is always 1.

IP Address

Displays the IP address of the SEHI.

SubNet Mask

Displays the subnet mask for the SEHI. A subnet mask is a 32-bit quantity which “masks out” the network bits of the IP address. This is done by setting the bits in the mask to 1 when the network treats the corresponding bits in the IP address as part of the network or subnetwork address, or to 0 if the corresponding bit identifies the host.

MAC Address

Displays the physical address associated with the interface.

Default Gateway

Displays the default gateway for the SEHI. This field is not defined until you enter an appropriate value. The default gateway identifies the default gateway device that will forward packets to other IP subnetworks.

Serial Port Application

Displays the port's application setting as CONSOLE.

Baud Rate

Displays the Baud Rate setting of the device attached to the SEHI through the serial port. The setting for the serial port is 9600.

Port Enable Override

This command lets you override the Disable Port settings in the Device Statistics screen to enable all ports in the stack.

Setting the IP Address

To set the IP Address:

1. Use the arrow keys to highlight the **IP Address** field.
2. Enter the IP address into this field. The format for this entry is **XXX.XXX.XXX.XXX**, with values for **XXX** being from 0 to 255. The screen beeps if you enter non-numeric or adjacent dots. If the entry does not have three dots it will be rejected.
3. Press **Return**. The IP address appears and the natural subnet mask for the user is generated and appears also.

LOCAL MANAGEMENT

4. Use the arrow keys to highlight the **SAVE** option, then press the **Return** key or **F6**. The “SAVED OK” message appears indicating that the changes have been saved to memory.

Please note that the first time you try to exit the screen without saving your changes, you will get a “NOT SAVED?” message. If you proceed to exit without saving, you will lose your edits.

Setting the Subnet Mask

***Note:** Consult your Network Administrator prior to setting the Subnet Mask.*

The subnet mask defines how your SEHI treats SNMP Trap IP destination addresses in its Trap Table.

- Set the subnet mask when workstations in the Trap Table reside on a different subnet (i.e., across a gateway or router), and you want these workstations to receive SNMP traps.
- Use the subnet mask factory default setting of 0.0.0.0 when all trap designated workstations are on the SEHI subnet.

To set the subnet mask:

1. Use the arrow keys to highlight the **SubNET Mask** field.
2. Enter the subnet mask into this field. The format for this entry is XXX.XXX.XXX.XXX with values for XXX being from 0 to 255.
3. Press the **Return** key.
4. Use the arrow keys to highlight the **SAVE** option, then press the **Return** key or **F6**. The “SAVED OK” message appears indicating that the changes have been saved to memory.

Please note that the first time you try to exit the screen without saving your changes, you will get a “NOT SAVED?” message. If you proceed to exit without saving, you will lose your edits.

Setting the Default Gateway

The Default Gateway field allows you to describe the router through which the SEHI will be forwarding IP packets.

To set the Default Gateway:

1. Use the arrow keys to highlight the **Default Gateway** field.
2. Enter the gateway's default mask in this field. The format for this entry is XXX.XXX.XXX.XXX with values for XXX being from 0 to 255.
3. Press the **Return** key. If your entry is accepted as a valid default gateway, "OK" appears to the right of the field.
4. Use the arrow keys to highlight the **SAVE** option, then press the **Return** key or **F6**. The "SAVED OK" message appears indicating that the changes have been saved to memory.

Using the Port ENABLE Override

To set the Port ENABLE Override:

1. Use the arrow keys to highlight the **Port ENABLE Override** field.
2. Press the **Return** key to toggle from the default setting of "OVERRIDE DISABLED" to "OVERRIDE ENABLED".
3. The adjacent field displays "Y/N". Enter **Y** to continue enabling all of the ports, or **N** to discontinue the port enable override. If you answer **Y**, all existing ports are enabled, and the message "PORT ENABLED" appears.

LOCAL MANAGEMENT

Exiting the Configuration Screen

1. To exit the Configuration screen, press the appropriate **Function key**. To return to the Feature Selection screen, use the arrow keys to highlight the RETURN command.
2. Press the **Return** key. The Feature Selection screen appears.

6.3.3 The Trap Table Screen

To access the Trap Table screen from the Features Selection screen, use the arrow keys to highlight the **Component Trap Table** option, then press the **Return** key or **F8**. The Trap Table screen shown in Figure 6-6 appears.

SNMP Community Name	Traps	IP Address
<CR>	N	0.0.0.0
<CR>	N	0.0.0.0
<CR>	N	0.0.0.0
<CR>	N	0.0.0.0
<CR>	N	0.0.0.0
<CR>	N	0.0.0.0
<CR>	N	0.0.0.0
<CR>	N	0.0.0.0

SAVE	COMMUNITY NAMES	IP TABLE	SNMP TOOLS	RETURN
F6	F7	F8	F9	

Figure 6-6. Trap Table Screen

The Trap Table defines the management stations that will receive SNMP Traps for alarm/event notification. The following sections explain each field on the Trap Table screen and instructions on how to change them.

SNMP Community Name

Displays the community name to be included in the trap message, which is sent to the Network Management Station with the associated IP address.

Traps

Enables transmission of the traps to the network management station with the associated IP address.

Trap IP Address

Indicates the IP address of the workstation to receive trap alarms from the SEHI.

Configuring the Trap Table

1. Use the arrow keys to highlight the **SNMP Community Name** field, then enter the community name.
2. Press the **Return** key.
3. Use the arrow keys to highlight the **Traps** field and enter **Y** (or **y**) to send alarms from the SEHI to the workstation, or **N** (or **n**) to prevent alarms from being sent.
4. Press the **Return** key.
5. Use the arrow keys to highlight the appropriate **Trap IP Address** field.
6. Enter the IP address of the workstation that you want to send traps to in this field. The format for this entry is **XXX.XXX.XXX.XXX**, with the value of **XXX** ranging from 0 to 255, and three dots, or else it returns to the beginning of the field.
7. Use the arrow keys to highlight the **SAVE** option, then press the **Return** key or **F6**. The "SAVED OK" message appears indicating that the changes have been saved to memory.

Exiting the Trap Table Screen

1. To exit the Trap Table screen, press the appropriate Function key. To exit to the Feature Selection screen, use the arrow keys to highlight the RETURN command.
2. Press the **Return** key. The Feature Selection screen appears.

6.3.4 The SNMP Tools Screen

This section describes how you can use the SNMP Tools screen to access Management Information Bases (MIBs). Access to screen options depends on the access status accorded to your community name. This section describes Super-User management capabilities.

SNMP Tools allows you access to valuable MIB information. You can get information about specific object identifiers (OIDs), edit the values of configurable OIDs, and request the OID numerically sequential to the originally requested OID.

Other ways to view OIDs from the SNMP Tools screen include Walking, Stepping, and Cycling. Walk and Cycle let you review several OIDs at a time.

To access the SNMP Tools screen from the Features Selection screen, use the arrow keys to highlight the **SNMP Tools Support** option, then press the **Return** key or **F9**. The SNMP Tools screen shown in Figure 6-7 appears.

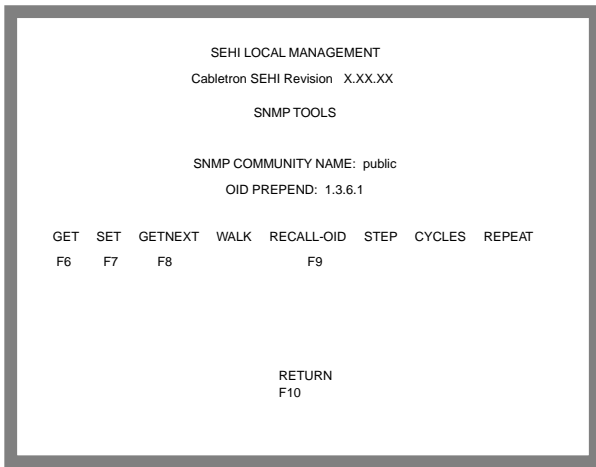

Figure 6-7. SNMP Tools Screen

The following sections describe SNMP Tools screen fields and instructions on how to change them.

Community Name

Identifies the community name used as a password to determine access level to the MIB component.

OID Prepend

Specifies the number prefix common to all Object Identifiers (OIDs) found in the MIBs - 1.3.6.1 is the default prefix OID. This is a modifiable field.

Get

Lets you retrieve MIB objects using SNMP protocol.

Set

Lets users with Read-Write and Super-User access change modifiable MIB objects, using SNMP protocol.

Get Next

Displays the OID following the current OID.

LOCAL MANAGEMENT

Walk

Scrolls you through a section of the MIB leaf by leaf, from a user-specified object identifier. Leaves are the sections of the OID separated by periods. When a walk is initialized you will see the following categories for each walk entry, or step.

Specified OID - gives the number tag for that OID.

Size - identifies the number of bytes it takes to store that object.

Type - specifies the object's variable type (e.g., int = integer).

Data - displays what the object identifier represents.

Recall-OID

Recalls, from memory, the last OID used.

Step

Displays the MIB walk, step by step, giving you time to view specific leaves in detail.

Cycles

Allows you to specify the number of get next requests to cycle through and how much time will elapse between each request.

Repeat

Repeats the last Get command, allowing you to monitor changes to a specific OID.

Getting Individual OIDs

To get an OID:

1. Highlight **GET**, using the arrow keys, then press the **Return** key (or press the **F6** function key). “<GET> OID (= | F9)” appears.
2. Enter the OID either by:
 - using the keyboard to enter the OID minus the OID’s prepend (e.g., if the prepend is 1.3.6.1, and you enter 4.1.3, then the OID=1.3.6.1.4.1.3).
 - entering an ‘=’ and the OID suffix (e.g., if you enter =4.1.3, then the OID=4.1.3). This allows you to digress and not use the prepend.
 - pressing **F9** to recall an OID already entered. You can then use the keyboard to modify the recalled OID as necessary.
3. Press the **Return** key. If there is no instance of that OID, the return code will specify “MIB_NO_INSTANCE”, otherwise, information about that OID’s data type, length, and value appear.

Getting the Next OID

To get the next OID:

1. Highlight **GETNEXT**, using the arrow keys, then press the **Return** key (or press the **F8** function key). “<GETNEXT> OID (= | F9)” appears.
2. Enter the desired **OID**, or OID extension. (Press F9 to recall the last OID request. You can then modify the recalled OID as necessary.)
3. Press the **Return** key. If there is no instance of that OID, the return code will specify “MIB_NO_INSTANCE”, otherwise, information about that OID’s data type, length, and value appear.

LOCAL MANAGEMENT

Setting an OID

To set an OID:

1. Highlight **SET**, using the arrow keys, then press the **Return** key (or press the **F7** function key). “<SET> OID (= | F9)” appears.
2. Enter the OID, minus the OID’s prepend. If you have previously entered an OID, pressing **F9** recalls that entry for you. You can then use the arrow keys to modify the recalled OID if necessary.
3. Press the **Return** key. If there is no instance of that OID, the return code will specify “MIB_NO_INSTANCE”, otherwise “DATA TYPE:” appears.
4. Enter the data type for that OID. Possible choices are: integer, string, null, OID, IP address, counter, gauge, timeticks, and opaque.
5. Press the **Return** key. “DATA” appears.
6. Enter the value to correspond to the OID. If accepted, “<SET> OPERATION CODE: XXXX <OK>” appears, otherwise an error message appears.

Viewing Multiple OIDs

Viewing several object identifiers at one time allows you to quickly scan a MIB for the specific information that you need. The Walk scrolls through OIDs numerically sequential to the initial OID request. The Step command scrolls the MIB Walk, one OID at a time. Cycling allows you to specify how many GetNext commands to cycle through for one OID.

Walking Through OIDs

To walk through an OID:

1. Highlight **Walk**, using the arrow keys, then press the **Return** key. “<INITIAL> OID (= | F9)” appears.
2. Enter the OID (minus the prepend) and press the **Return** key. The screen will begin walking through the sublayers of the MIB available from the specified OID. Each OID listed displays the specified OID, its size, its type, and the data it contains.
3. Press the **Space Bar** to stop the walk, or wait for “***MIB WALK COMPLETED***” to appear on the screen.

Stepping Through OIDs

To step through an OID (you can step through only after a GetNext):

1. Highlight **Step**, using the arrow keys, then press the **Return** key. “Specify OID” appears.
2. Enter the OID (only the suffix is necessary) and press **Return**. The Tools screen will begin to scroll one OID at a time, through all of the sublayers of the MIB available for that OID.

Cycling Through OIDs

To cycle through an OID:

1. Use the arrow keys to Highlight **CYCLES**, then press **Return**.
2. Enter the number of cycles that you want to occur after “ENTER CYCLE COUNT:”, then press the **Return** key.
3. Enter how many seconds delay that you want between get next requests after “ENTER CYCLE DELAY (secs):”, then press the **Return** key.

LOCAL MANAGEMENT

Exiting the SNMP Tools Screen

1. Use the arrow keys to highlight the RETURN command.
2. Press the **Return** key. The Feature Selection screen appears.

6.3.5 The Device Statistics Screen

This section describes the features of the Device Statistics screen. You can view error, collision, and traffic statistics for the stack, a selected module, or a selected port. You can also enable and disable ports.

To access the Statistics screen from the Features Selection screen, use the arrow keys to highlight the **Device Statistics** option, then press the **Return** key. The Device Statistics screen shown in Figure 6-8 appears.

```
SEHI LOCAL MANAGEMENT
Cabletron SEHI Revision X.XX.XX

DEVICE STATISTICS

STACK TOTAL      MODULE: 1      PORT: 1
BYTES RECEIVED:  3792125      67960      67960
FRAMES RECEIVED: 16547        255        255

ERRORS RECEIVED: 0          0          0
COLLISIONS:      0          0          0
OOW COLLISIONS:  0          0          0
CRC ERRORS:      0          0          0
ALIGNMENT ERRORS: 0          0          0
RUNT PACKETS:    0          0          0
GIANT PACKETS:   0          0          0
PORT ADMIN. STATUS: 0          0          0
PORT SEG. STATUS:          0          0          0
                                     ENABLE
                                     UNSEGMENTED

ENABLE PORT      DISABLE PORT
UPDATE -FREQ 3 Sec  MODULE 1      PORT 1      RETURN
```

Figure 6-8. Device Statistics Screen

The following sections describe Device Statistics screen fields and instructions on how to change them.

Bytes Received

Displays the number of bytes received.

Frames Received

Displays the number of frames received.

Errors Received

Displays the number of errors received.

Collisions

Displays the number of collisions received.

OOW Collisions

Displays the number of Out Of Window collisions. OOW collisions are usually caused by the network being too long where the round trip propagation delay is greater than $51.2 \mu \text{sec}$ (the collision domain is too large), a station somewhere on the network is violating Carrier Sense and transmitting at will, or a cable somewhere on the network failed during the transmission of the packet.

CRC Errors

Displays the number of packets with bad Cyclic Redundancy Checks (CRC) that have been received from the network. The CRC is a 4 byte field in the data packet that ensures that the transmitted data that is received is the same as the data that was originally sent.

Alignment Errors

Displays the number of errors due to misaligned packets.

Runt Packets

Displays the number of runt packets received from the network. A runt packet is less than the minimum Ethernet frame size of 64 bytes, not including preamble.

Giant Packets

Displays the number of packets received whose size exceeded 1518 data bytes, not including preamble.

Port Admin. Status

Displays the administrative status of the port selected. The two possible status messages are Enable or Disable.

LOCAL MANAGEMENT

Port Seg. Status

Displays the segmentation status of the port selected. The two possible status messages are Segmented or Unsegmented. The SEHI and SEH automatically partition problem segments, and reconnect non-problem segments to the network.

Enable Port

This command lets you enable the selected port.

Disable Port

This command lets you Disable the selected port.

Update-Freq

This command lets you select the time interval between Stack/Module/Port counter updates. You can choose update intervals in increments of 3 seconds, with the Maximum interval being 99 seconds.

Module

This command lets you view statistics for a selected module in the stack. The SEHI is Module 1 and each SEH in the stack follows in sequential order. Figure 6-9 shows each module number in the stack.

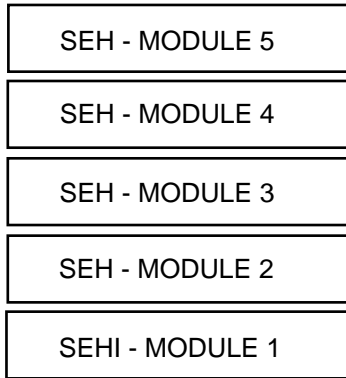

Figure 6-9. Module Number Sequence

Port

This command lets you view port statistics for ports 1-26 of the selected module.

Selecting the Appropriate Module/Port

When the Device Statistics screen first appears, statistics are displayed for Module 1 and Port 1. To view statistics for another module and port, use the **Module x** or **Port x** commands at the bottom of the screen.

To select a module or port:

1. Use the arrow keys to highlight the Module or Port command.
2. Press the **shift** and + keys, or the - key until the desired module or port number appears.
3. Press the **Return** key. Statistics associated with the selected Module and Port appear.

Using the Enable Port Command

The Enable Port command lets you enable the port selected in the Port command. You must first use the Port command to select the desired port.

To set the Port Enable command:

1. Use the arrow keys to highlight the **Enable Port** command at the bottom of the screen.
2. Press the **Return** key. The corresponding port is enabled and the Port Admin Status field is updated.

LOCAL MANAGEMENT

Using the Disable Port Command

The Disable Port command lets you Disable the port selected in the Port command. You must first use the Port command to select the desired port.

To set the Port Disable command:

1. Use the arrow keys to highlight the **Disable Port** command at the bottom of the screen.
2. Press the **Return** key. The corresponding port is enabled and the Port Admin Status field is updated.

Exiting the Device Statistics Screen

To exit the Device Statistics screen:

1. Use the arrow keys to highlight the RETURN command at the bottom of the screen.
2. Press the **Return** key. The Feature Selection screen appears.

APPENDIX A

TWISTED PAIR WIRING TABLES

This appendix contains twisted pair wiring tables which will assist you if you are using a Punch Down Block (see Figure A-1) to wire your twisted pair segments. The following tables are included in this appendix:

- Table A-1 Twisted Pair Wiring from an SEH to a Punch Down Block
- Table A-2 Twisted Pair Wiring from a Punch Down Block to a 10BASE-T Device
- Table A-3 Twisted Pair Wiring Summary

TWISTED PAIR WIRING TABLES

Note: Pins 25 and 50 on Champ connector are not used.

Table A-1. Twisted Pair Wiring
from an SEHI-32/34 to a Punch Down Block

From SEHI-32/34	Into and Out of 50 Pin Feeder Cable	Into Punch Down Block
Port 12/24		
Pin	Pin	Pin
RX+ 48	48 Violet/Green RX+	A45 Violet/Green RX+
RX- 23	23 Green/Violet RX-	A46 Green/Violet RX-
TX+ 49	49 Violet/Brown TX+	A47 Violet/Brown TX+
TX- 24	24 Brown/Violet TX-	A48 Brown/Violet TX-
Port 11/23		
Pin	Pin	Pin
RX+ 46	46 Violet/Blue RX+	A41 Violet/Blue RX+
RX- 21	21 Blue/Violet RX-	A42 Blue/Violet RX-
TX+ 47	47 Violet/Orange TX+	A43 Violet/Orange TX+
TX- 22	22 Orange/Violet TX-	A44 Orange/Violet TX-
Port 10/22		
Pin	Pin	Pin
RX+ 44	44 Yellow/Brown RX+	A37 Yellow/Brown RX+
RX- 19	19 Brown/Yellow RX-	A38 Brown/Yellow RX-
TX+ 45	45 Yellow/Gray TX+	A39 Yellow/Gray TX+
TX- 20	20 Gray/Yellow TX-	A40 Gray/Yellow TX-
Port 9/21		
Pin	Pin	Pin
RX+ 42	42 Yellow/Orange RX+	A33 Yellow/Orange RX+
RX- 17	17 Orange/Yellow RX-	A34 Orange/Yellow RX-
TX+ 43	43 Yellow/Green TX+	A35 Yellow/Green TX+
TX- 18	18 Green/Yellow TX-	A36 Green/Yellow TX-

TWISTED PAIR WIRING TABLES

Table A-1. Twisted Pair Wiring
from an SEHI-32/34 to a Punch Down Block (Continued)

From SEHI-32/34	Into and Out of 50 Pin Feeder Cable		Into Punch Down Block
Port 8/20			
	Pin	Pin	Pin
RX+	40	40 Black/Gray RX+	A29 Black/Gray RX+
RX-	15	15 Gray/Black RX-	A30 Gray/Black RX-
TX+	41	41 Yellow/Blue TX+	A31 Yellow/Blue TX+
TX-	16	16 Blue/Yellow TX-	A32 Blue/Yellow TX-
Port 7/19			
	Pin	Pin	Pin
RX+	38	38 Black/Green RX+	A25 Black/Green RX+
RX-	13	13 Green/Black RX-	A26 Green/Black RX-
TX+	39	39 Black/Brown TX+	A27 Black/Brown TX+
TX-	14	14 Brown/Black TX-	A28 Brown/Black TX-
Port 6/18			
	Pin	Pin	Pin
RX+	36	36 Black/Blue RX+	A21 Black/Blue RX+
RX-	11	11 Blue/Black RX-	A22 Blue/Black RX-
TX+	37	37 Black/Orange TX+	A23 Black/Orange TX+
TX-	12	12 Orange/Black TX-	A24 Orange/Black TX-
Port 5/17			
	Pin	Pin	Pin
RX+	34	34 Red/Brown RX+	A17 Red/Brown RX+
RX-	9	9 Brown/Red RX-	A18 Brown/Red RX-
TX+	35	35 Red/Gray TX+	A19 Red/Gray TX+
TX-	10	10 Gray/Red TX-	A20 Gray/Red TX-

TWISTED PAIR WIRING TABLES

Table A-1. Twisted Pair Wiring
from an SEHI-32/34 to a Punch Down Block (Continued)

From SEHI-32/34	Into and Out of 50 Pin Feeder Cable	Into Punch Down Block
Port 4/16		
Pin	Pin	Pin
RX+ 32	32 Red/Orange RX+	A13 Red/Orange RX+
RX- 7	7 Orange/Red RX-	A14 Orange/Red RX-
TX+ 33	33 Red/Green TX+	A15 Red/Green TX+
TX- 8	8 Green/Red TX-	A16 Green/Red TX
Port 3/15		
Pin	Pin	Pin
RX+ 30	30 White/Gray RX+	A9 White/Gray RX+
RX- 5	5 Gray/White RX-	A10 Gray/White RX-
TX+ 31	31 Red/Blue TX+	A11 Red/Blue TX+
TX- 6	6 Blue/Red TX-	A12 Blue/Red TX-
Port 2/14		
Pin	Pin	Pin
RX+ 28	28 White/Green RX+	A5 White/Green RX+
RX- 3	3 Green/White RX-	A6 Green/White RX-
TX+ 29	29 White/Brown TX+	A7 White/Brown TX+
TX- 4	4 Brown/White TX-	A8 Brown/White TX-
Port 1/13		
Pin	Pin	Pin
RX+ 26	26 White/Blue RX+	A1 White/Blue RX+
RX- 1	1 Blue/White RX-	A2 Blue/White RX-
TX+ 27	27 White/Orange TX+	A3 White/Orange TX+
TX- 2	2 Orange/White TX-	A4 Orange/White TX-

TWISTED PAIR WIRING TABLES

Table A-2. Twisted Pair Wiring
from a Punch Down Block to a 10Base-T Device

From Punch Down Block	To RJ-45 Wallplate	Into Office Drop	Into 10BASE-T Device
Port 12/24	Pin	Pin	Pin
B45 Violet/Green RX+	1 TX+	1 TX+	1 TX+
B46 Green/Violet RX-	2 TX-	2 TX-	2 TX-
B47 Violet/Brown TX+	3 RX+	3 RX+	3 RX+
B48 Brown/Violet TX-	6 RX-	6 RX-	6 RX-
Port 11/23	Pin	Pin	Pin
B41 Violet/Blue RX+	1 TX+	1 TX+	1 TX+
B42 Blue/Violet RX-	2 TX-	2 TX-	2 TX-
B43 Violet/Orange TX+	3 RX+	3 RX+	3 RX+
B44 Orange/Violet TX-	6 RX-	6 RX-	6 RX-
Port 10/22	Pin	Pin	Pin
B37 Yellow/Brown RX+	1 TX+	1 TX+	1 TX+
B38 Brown/Yellow RX-	2 TX-	2 TX-	2 TX-
B39 Yellow/Gray TX+	3 RX+	3 RX+	3 RX+
B40 Gray/Yellow TX-	6 RX-	6 RX-	6 RX-
Port 9/21	Pin	Pin	Pin
B33 Yellow/Orange RX+	1 TX+	1 TX+	1 TX+
B34 Orange/Yellow RX-	2 TX-	2 TX-	2 TX-
B35 Yellow/Green TX+	3 RX+	3 RX+	3 RX+
B36 Green/Yellow TX-	6 RX-	6 RX-	6 RX-

TWISTED PAIR WIRING TABLES

Table A-2. Twisted Pair Wiring
from a Punch Down Block to a 10Base-T Device (Continued)

From Punch Down Block		To RJ-45 Wallplate	Into Office Drop	Into 10BASE-T Device
Port 8/20		Pin	Pin	Pin
B29	Black/Gray RX+	1 TX+	1 TX+	1 TX+
B30	Gray/Black RX-	2 TX-	2 TX-	2 TX-
B31	Yellow/Blue TX+	3 RX+	3 RX+	3 RX+
B32	Blue/Yellow TX-	6RX-	6 RX-	6 RX-
Port 7/19		Pin	Pin	Pin
B25	Black/Green RX+	1 TX+	1 TX+	1 TX+
B26	Green/Black RX-	2 TX-	2 TX-	2 TX-
B27	Black/Brown TX+	3 RX+	3 RX+	3 RX+
B28	Brown/Black TX-	6 RX-	6 RX-	6 RX-
Port 6/18		Pin	Pin	Pin
B21	Black/Blue RX+	1 TX+	1 TX+	1 TX+
B22	Blue/Black RX-	2 TX-	2 TX-	2 TX-
B23	Black/Orange TX+	3 RX+	3 RX+	3 RX+
B24	Orange/Black TX-	6 RX-	6 RX-	6 RX-
Port 5/17		Pin	Pin	Pin
B17	Red/Brown RX+	1 TX+	1 TX+	1 TX+
B18	Brown/Red RX-	2 TX-	2 TX-	2 TX-
B19	Red/Gray TX+	3 RX+	3 RX+	3 RX+
B20	Gray/Red TX-	6 RX-	6 RX-	6 RX-

TWISTED PAIR WIRING TABLES

Table A-2. Twisted Pair Wiring
from a Punch Down Block to a 10Base-T Device (Continued)

From Punch Down Block	To RJ-45 Wallplate	Into Office Drop	Into 10BASE-T Device
Port 4/16	Pin	Pin	Pin
B13 Red/Orange RX+	1 TX+	1 TX+	1 TX+
B14 Orange/Red RX-	2 TX-	2 TX-	2 TX-
B15 Red/Green TX+	3 RX+	3 RX+	2 TX-
B16 Green/Red TX-	6 RX-	6 RX-	6 RX-
Port 3/15	Pin	Pin	Pin
B9 White/Gray RX+	1 TX+	1 TX+	1 TX+
B10 Gray/White RX-	2 TX-	2 TX-	2 TX-
B11 Red/Blue TX+	3 RX+	3 RX+	3 RX+
B12 Blue/Red TX-	6 RX-	6 RX-	6 RX-
Port 2/14	Pin	Pin	Pin
B5 White/Green RX+	1 TX+	1 TX+	1 TX+
B6 Green/White RX-	2 TX-	2 TX-	2 TX-
B7 White/Brown TX+	3 RX+	3 RX+	3 RX+
B8 Brown/White TX-	6 RX-	6 RX-	6 RX-
Port 1/13	Pin	Pin	Pin
B1 White/Blue RX+	1 TX+	1 TX+	1 TX+
B2 Blue/White RX-	2 TX-	2 TX-	2 TX-
B3 White/Orange TX+	3 RX+	3 RX+	3 RX+
B4 Orange/White TX-	6 RX-	6 RX-	6 RX-

TWISTED PAIR WIRING TABLES

Table A-3. Twisted Pair Wiring Summary

SEHI-32/34 Champ	Punch Down Block	Wall Plate (If Required)	10BASE-T Ethernet Device
Port 12			
48 RX+ 23 RX- 49 TX+ 24 TX-	{ 25 Pin Feeder Cable } A45 RX+ A46 RX- A47 TX+ A48 TX-	{ 4 Pair Twisted Distribution Cable }	{ Office Drop } PIN 1 TX+ PIN 2 TX- PIN 3 RX+ PIN 6 RX+
			PIN 1 TX+ PIN 2 TX- PIN 3 RX+ PIN 6 RX+
Port 11			
46 RX+ 21 RX- 47 TX+ 22 TX-	{ 25 Pin Feeder Cable } A41 RX+ A42 RX- A43 TX+ A44 TX-	{ 4 Pair Twisted Distribution Cable }	{ Office Drop } PIN 1 TX+ PIN 2 TX- PIN 3 RX+ PIN 6 RX-
			PIN 1 TX+ PIN 2 TX- PIN 3 RX+ PIN 6 RX-
:	:	:	:
:	:	:	:
:	:	:	:
:	:	:	:
:	:	:	:
:	:	:	:
:	:	:	:
:	:	:	:
:	:	:	:
:	:	:	:
:	:	:	:
:	:	:	:
Port 1			
26 RX+ 1 RX- 27 TX+ 2 TX-	{ 25 Pin Feeder Cable } A1 RX+ A2 RX- A3 TX+ A4 TX-	{ 4 Pair Twisted Distribution Cable }	{ Office Drop } PIN 1 TX+ PIN 2 TX- PIN 3 RX+ PIN 6 RX-
			PIN 1 TX+ PIN 2 TX- PIN 3 RX+ PIN 6 RX-

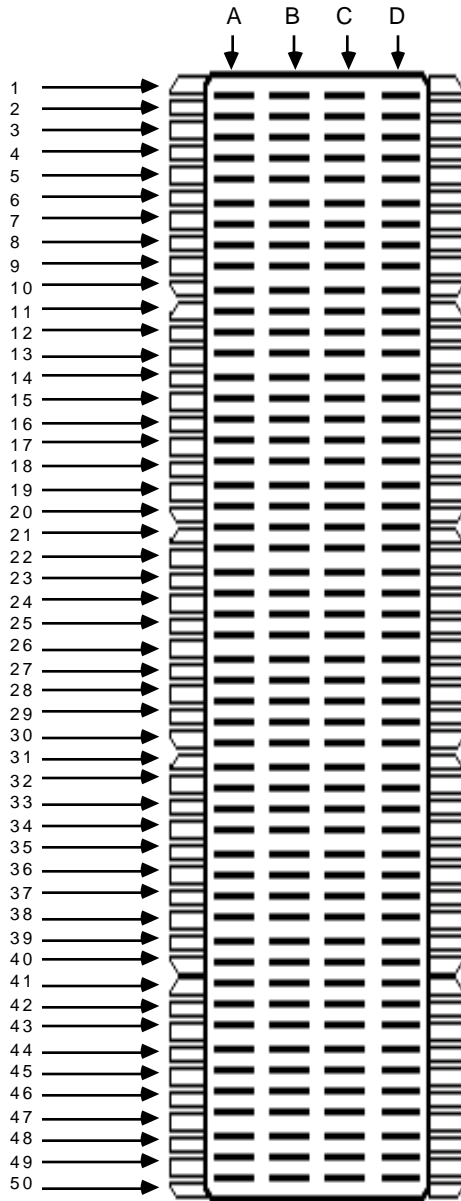

Figure A-1. Punch Down Block

POWER SUPPLY CORD

The mains cord used with this equipment must be a 2 conductor plus ground type with minimum 0.75 mm square conductors and must incorporate a standard IEC appliance coupler on one end and a mains plug on the other end which is suitable for the use and application of the product and that is approved for use in the country of application.

GERMAN:

Die Netzleitung, die mit diesem Geraet benuetzt wird, soll einen zwei Leiter mit Erdleiter haben, wobei die Leiter mindestens 0.75 mm sind, mit einer normalen IEC Geraetesteckdose an einem Ende und einem Geraetestecker am anderen Ende versehen sind, der fuer den Gebrauch und die Anwendung des Geraetes geeignet und der zum Benuetzen im Lande der Anwendung anerkannt ist.

SPANISH:

El cable principal de la red eléctrica utilizado con este equipo debe tener 2 conductores y 1 toma de tierra con un mínimo de 0.75 mm² cada uno y necesita tener un aparato de acoplamiento standard IEC en un extremo y un enchufe para el cable principal de la red eléctrica en el otro extremo, lo cual sea adecuado para el uso y aplicación del producto y lo cual sea aprobado para uso en el país de aplicación.

FRENCH:

Le cordon d'alimentation reliant cet appareil au secteur doit obligatoirement avoir deux fils conducteurs de 0.75 mm² minimum et un fil de terre. It doit également être équipé du côté appareil d'une fiche agréée IEC et du côté secteur, d'une prise adaptée à l'usage du produit et aux normes du pays où l'appareil est utilisé.