

# RADIANCE

# SONET

## SINGLE INTERFACE LINE CARDS

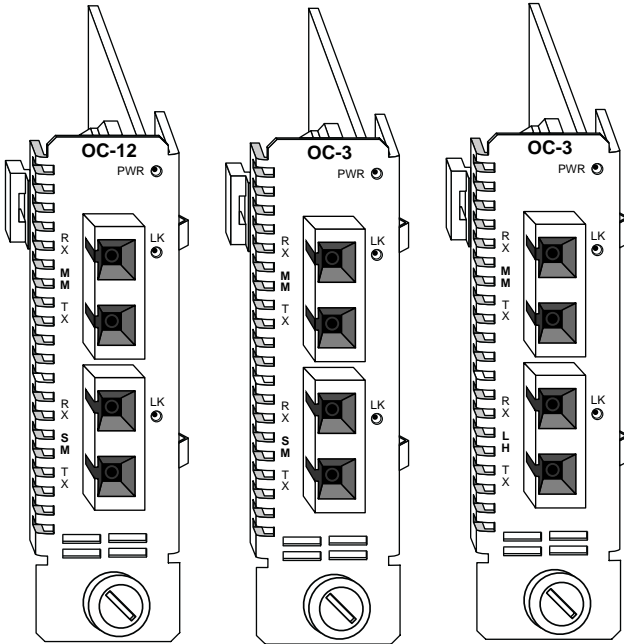

### *Installation & User Guide*

Models: R125-34 / R125-37 / R135-34

---

# ***Radiance SONET Single Interface Line Cards***

## **Fiber to Fiber:**

- R125-34 \_\_\_\_\_ OC-3/STM-1 multimode SC to singlemode SC
- R125-37 \_\_\_\_\_ OC-3/STM-1 multimode SC to singlemode SC (40 km)
- R135-34 \_\_\_\_\_ OC-12/STM-4 multimode SC to singlemode SC

This publication is protected by the copyright laws of the United States and other countries, with all rights reserved. No part of this publication may be reproduced, stored in a retrieval system, translated, transcribed, or transmitted, in any form, or by any means manual, electric, electronic, electromagnetic, mechanical, chemical, optical or otherwise, without prior explicit written permission of Metrobility Optical Systems, Inc.

# Table of Contents

## **Radiance SONET Single Interface Line Cards Installation & User Guide**

<b>Overview</b> .....	4
<b>Installation Guide</b> .....	5
STEP 1: Unpack the Line Card .....	5
STEP 2: Set the DIP Switches .....	5
STEP 3: Install the Line Card .....	8
STEP 4: Connect to the Network .....	8
<b>User Guide</b> .....	9
LED Indicators .....	9
Link Loss Return (LLR) .....	10
Link Loss Carry Forward (LLCF) .....	11
Topology Solutions .....	12
Technical Specifications .....	13
Product Safety, EMC and Compliance Statements .....	14
Warranty and Servicing .....	15

Metrobility, Metrobility Optical Systems, and NetBeacon are registered trademarks of Metrobility Optical Systems, Inc. The Metrobility Optical Systems logo is a trademark of Metrobility Optical Systems, Inc.

---

The information contained in this document is assumed to be correct and current. The manufacturer is not responsible for errors or omissions and reserves the right to change specifications at any time without notice.

# Overview

**The Radiance SONET single interface line card provides seamless** integration between fiber optic multimode and singlemode segments in OC-3/STM-1 or OC-12/STM-4 networks. Use the card's singlemode connector to extend your network reach up to 40 km.

The Radiance line card is manageable through console commands, Metrobility's GUI-based NetBeacon® or WebBeacon software, or any SNMP application. This ability provides software control over the card's configuration and notification of a failure to a management station.

The Radiance SONET single interface line card offers the following key features:

- Two Link Loss Return (LLR) switches and Link Loss Carry Forward (LLCF) to aid in troubleshooting remote network connections.
- Full-duplex support.
- OC-3/STM-1 (155Mbps) and OC-12/STM-4 (622Mbps) support.
- A link LED on each port to indicate that the port is receiving a signal.
- Reliable data transmission over multimode cables up to 2 km and singlemode cables up to 40 km.

# Installation Guide

Follow the simple steps outlined in this section to install and start using your Radiance SONET single interface line card.

**NOTE:** Electrostatic discharge precautions should be taken when handling any line card. Proper grounding is recommended (i.e., wear a wrist strap).

## 1 **Unpack the Line Card**

Your order has been provided with the safest possible packaging, but shipping damage does occasionally occur. Inspect your line card carefully. If you discover any shipping damage, notify your carrier and follow their instructions for damage and claims. Save the original shipping carton in case return or storage of the unit is necessary.

## 2 **Set the DIP Switches\***

A set of six DIP switches is located on the back of the line card. (See illustration.) Two of these switches are used to enable/disable Link Loss Return (LLR) and are clearly marked LLR1 and LLR2 on the printed circuit board.

The remaining switches, including the one labeled LLCF, are nonfunctional. Pushing these switches up and down has no effect. Link Loss Carry Forward (LLCF) is a feature that is always enabled.

When setting DIP switches, the UP position is when the lever of the DIP switch is pushed away from the circuit board. The DOWN position is when the lever is pushed toward the circuit board.

The default switch settings are LLR1 disabled (DOWN) and LLR2 disabled (DOWN).

---

\*DIP switches also can be controlled by console commands or with Metrobility's NetBeacon or WebBeacon management software. Refer to the *Command Line Interface Reference Guide*, *NetBeacon Element Management Software Installation & User's Guide* or *WebBeacon Management Software Installation & User's Guide* for software management information.

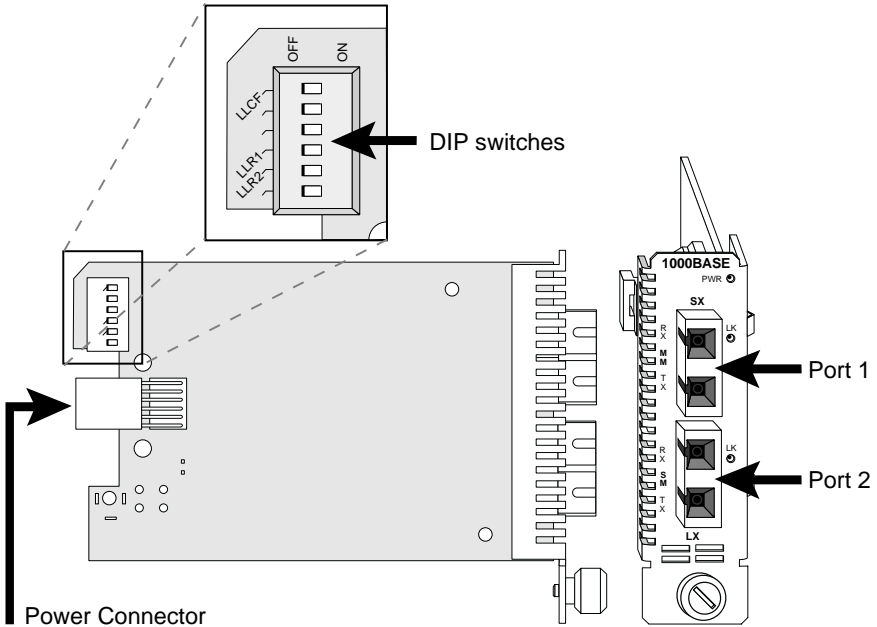

### ***Link Loss Return Switches***

The Radiance SONET single interface line card incorporates Link Loss Return (LLR) functionality as an aid in troubleshooting remote connections. LLR is enabled independently on each port. When LLR is enabled on a port, loss of its receive (RX) link disables its own transmit (TX) link.

LLR1 enables/disables Link Loss Return on Port 1, and LLR2 enables/disables the function on Port 2. To enable Link Loss Return for a port, set its LLR switch ON (up). Set the switch OFF (down) to disable the function.

For more information, refer to [Link Loss Return](#) in the User Guide section of this manual.

# 3 Install the Line Card

The Radiance SONET single interface line card offers the ease of plug-and-play installation and is hot-swappable. All cards must be firmly secured to the chassis before network connections are made. Follow the simple steps outlined below to install your line card.

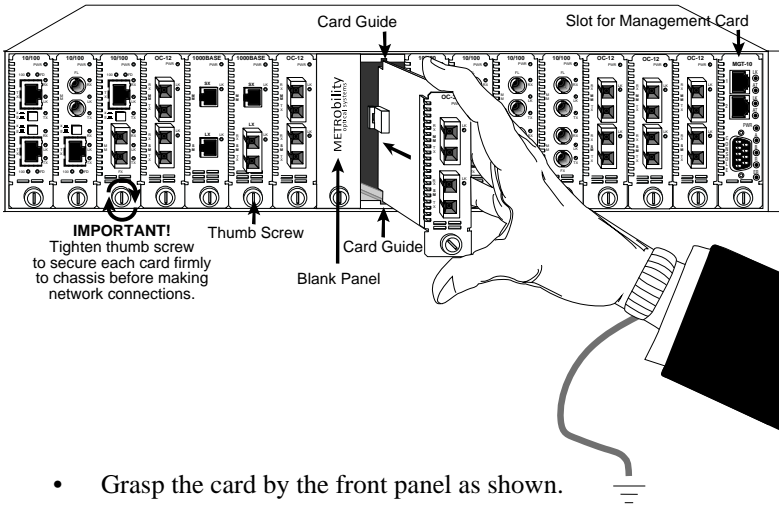

- Grasp the card by the front panel as shown.
- Insert the card into a slot on the chassis making sure that the top and bottom edges of the board are aligned with the top and bottom card guides in the chassis. Do not force the card into the chassis unnecessarily. It should slide in easily and evenly.
- Slide the card in until the top and bottom edges of the front panel are flush and even with the top and bottom edges of the chassis.
- To secure the line card to the chassis, turn the thumbscrew clockwise until it is snug. The card is now properly installed and ready for connection to the network.

# 4 **Connect to the Network**

To connect the Radiance line card to the network, insert the fiber optic cables into the appropriate SC connectors. (See the figure below.) Be sure the card is secured to the chassis before making network connections.

When making network connections, make sure that the transmit (TX) optical conductor of the line card connects to the receive (RX) optical conductor of the connected device; and be sure that the transmit (TX) optical conductor of the device connects to the receive (RX) optical conductor of the card.

Port 1 is the multimode (MM) interface. The OC-3/STM-1 models support a maximum segment length of 2 km. The OC-12/STM-4 line card supports a maximum segment length of 500 m.

Port 2 is either a singlemode (SM) or singlemode long haul (LH) interface. The SM port supports a maximum segment length of 15 km, and the LH port supports a maximum segment length of 40 km.

Once power is applied to the unit, correct connectivity can be verified via the link (LK) LED.

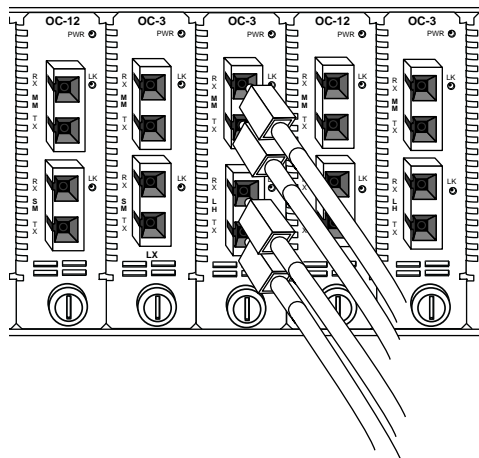



# User Guide

This section contains more information regarding the operating features of the Radiance SONET single interface line card.

## **LED Indicators**

The Radiance SONET single interface line card provides three LEDs on the front panel for the visible verification of unit status and proper functionality. These LEDs can assist with troubleshooting and overall network diagnosis and management.

When lit, the LEDs indicate the following status:

- **PWR** (power): The unit is powered ON.
- **LK** (Port 1): Port 1 is receiving valid input light level.
- **LK** (Port 2): Port 2 is receiving valid input light level.

## Link Loss Return (LLR)

Both ports on the Radiance SONET single interface line card have been designed with LLR for troubleshooting a remote connection. When LLR is enabled\*, the port's transmitter shuts down if its receiver fails to detect a valid receive link. LLR should only be enabled on one end of a cable and is typically enabled on either the unmanaged or remote device. LLR works in conjunction with Link Loss Carry Forward.

The diagram below shows a typical network configuration with good link status using two SONET line cards for remote connectivity. Note that LLR is enabled as indicated in the diagram.

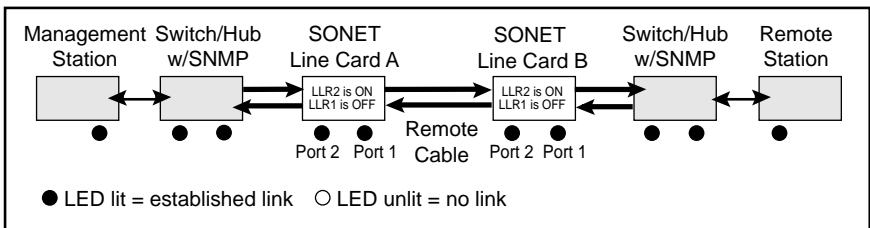

Example: If one of the optical conductors breaks (as shown in the diagram box below), Line Card B, with LLR2 enabled, will return a no-link condition to its link partner, Line Card A. Because the line cards are designed with LLCF functionality, the no-link condition is carried forward to the switch/hub where a trap is generated to the management station. The network administrator can then determine the source of the loss.

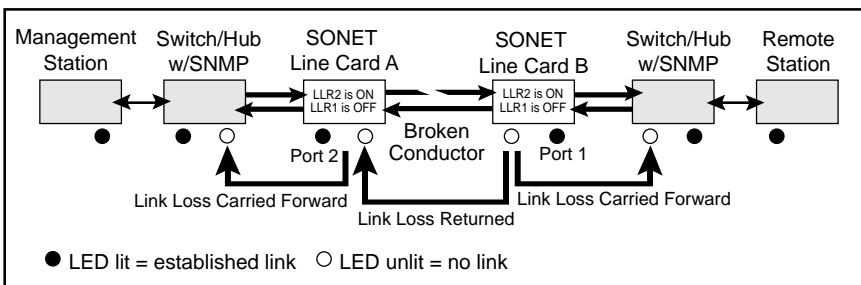

**IMPORTANT:** LLR must not be active on both ends of a configuration. If it is, the link can never be established.

\*Units are shipped with the LLR function disabled (DOWN).

## Link Loss Carry Forward (LLCF)

The Radiance SONET single interface line card incorporates LLCF for troubleshooting a remote connection. With LLCF, the ports do not transmit a signal until they receive a signal from the opposite port. For example, if a line card loses link on Port 2, the card will not transmit link pulses out of Port 1.

The diagram below shows a typical network configuration with good link status using SONET line cards for remote connectivity.

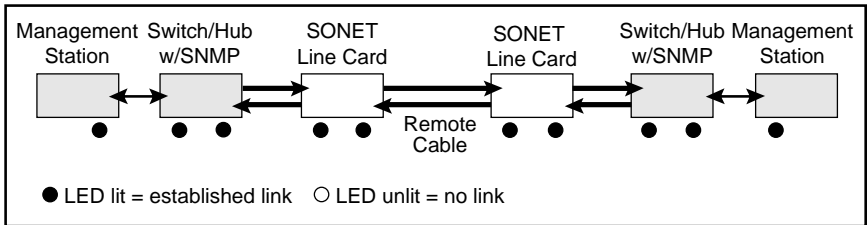

If a connection breaks, the line cards carry that link loss forward to the switch/hub which generates a trap to the management station. The network administrator can then determine the source of the problem.

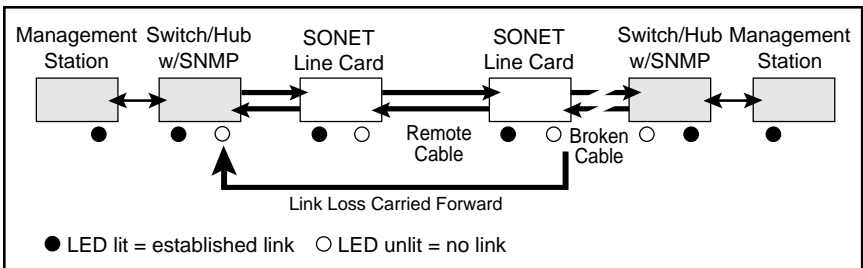
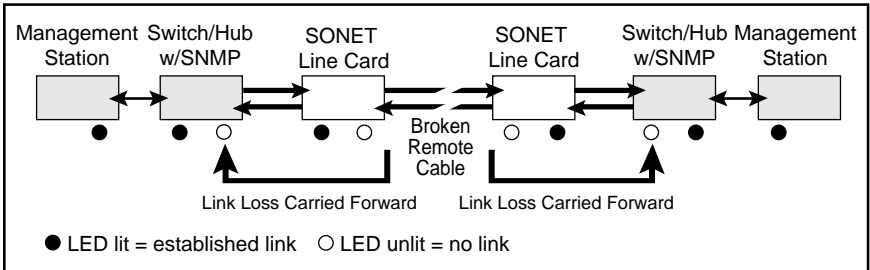

# Topology Solutions

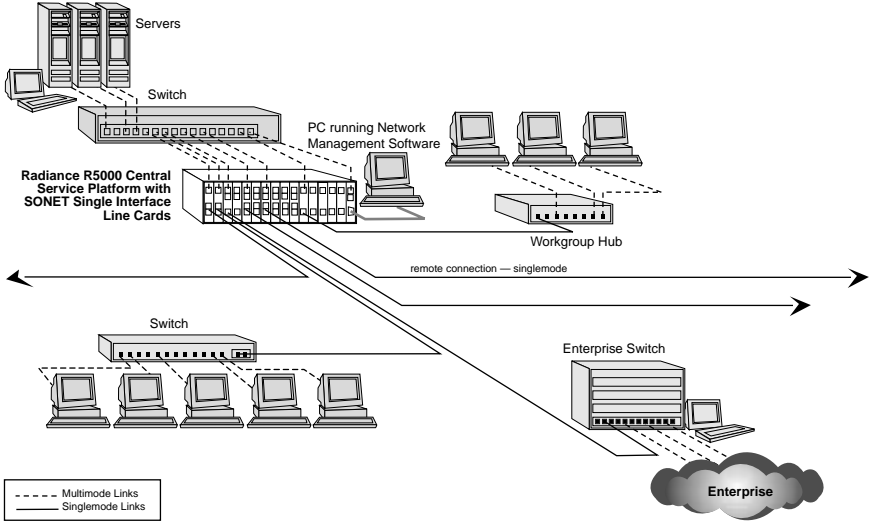

# Technical Specifications

Protocol	Fiber Type and Models	Wave Length	Cable Length	Cable Size Core/ Clad	RX Input Power (min)	RX Input Power (sat)	TX Output Power (min)	TX Output Power (max)	Power Budget (TX Pwr <sub>min</sub> - RX Pwr <sub>min</sub> )
OC-3/ STM-1	MM (R125-34/ R125-37)	1310nm	2km (rated)	50µm/ 125µm	-30dBm	-14dBm	-23.5dBm	-14dBm	6.5dBm
				62.5µm/ 125µm	-30dBm	-14dBm	-20dBm	-14dBm	10dBm
	SM (R125-34)	1310nm	15km (rated, based on power budget)	9µm/ 125µm	-35dBm	-8dBm	-15dBm	-8dBm	20dBm
OC-12/ STM-4	MM	1310nm	500m (rated)	50µm/ 125µm	-26dBm	-14dBm	-22.5dBm	-14dBm	3.5dBm
				62.5µm/ 125µm	-26dBm	-14dBm	-20dBm (typical)	-14dBm	6dBm
	SM	1310nm	15km (rated)	9µm/ 125µm	-28dBm	-7dBm	-15dBm	-8dBm	13dBm

## Data Rate

Data Rate \_\_\_\_\_ 155Mbps (OC-3/STM-1), 622Mbps (OC12/STM-4)

## Power Consumption

Input \_\_\_\_\_ 5V @ 0.8A, 4W

## Environmental

Operating Temperature \_\_\_\_\_ 0° to 50° C

Storage Temperature \_\_\_\_\_ -30° to 70° C

Operating Humidity \_\_\_\_\_ 5% to 95% non-condensing

Weight \_\_\_\_\_ 5 oz (0.14 kg)

## ***Product Safety, EMC and Compliance Statements***

This equipment complies with the following requirements:

- UL
- CSA
- EN60950 (safety)
- FCC Part 15, Class A
- EN55022 Class A (emissions)
- EN50082-1 (immunity)
- IEC 825-1 Classification
- Class 1 Laser Product
- DOC Class A (emissions)

This product shall be handled, stored and disposed of in accordance with all governing and applicable safety and environmental regulatory agency requirements.

The following *FCC* and *Industry Canada* compliance information is applicable to North American customers only.

### ***USA FCC Radio Frequency Interference Statement***

This equipment has been tested and found to comply with the limits for a Class A digital device, pursuant to Part 15 of the FCC Rules. These limits are designed to provide reasonable protection against harmful interference when the equipment is operated in a commercial environment. This equipment generates, uses and can radiate radio frequency energy, and if not installed and used in accordance with the instruction manual, may cause harmful interference to radio communications. Operation of this equipment in a residential area is likely to cause harmful interference in which case the user will be required to correct the interference at his own expense.

***Caution:*** *Changes or modifications to this equipment not expressly approved by the party responsible for compliance could void the user's authority to operate the equipment.*

### ***Canadian Radio Frequency Interference Statement***

This Class A digital apparatus meets all requirements of the Canadian Interference-Causing Equipment Regulations.

Cet appareil numérique de la classe A respecte toutes les exigences du Règlement sur le matériel brouilleur du Canada.

## ***Warranty and Servicing***

### **Three-Year Warranty for Radiance SONET Single Interface Line Card**

Metrobility Optical Systems, Inc. warrants that every Radiance SONET single interface line card will be free from defects in material and workmanship for a period of THREE YEARS from the date of Metrobility shipment. This warranty covers the original user only and is not transferable. Should the unit fail at any time during this warranty period, Metrobility will, at its sole discretion, replace, repair, or refund the purchase price of the product. This warranty is limited to defects in workmanship and materials and does not cover damage from accident, acts of God, neglect, contamination, misuse or abnormal conditions of operation or handling, including overvoltage failures caused by use outside of the product's specified rating, or normal wear and tear of mechanical components.

To establish original ownership and provide date of purchase, complete and return the registration card or register the product online at [www.metrobility.com](http://www.metrobility.com). If product was not purchased directly from Metrobility, please provide source, invoice number and date of purchase.

To return a defective product for warranty coverage, contact Metrobility Customer Service for a return materials authorization (RMA) number. Send the defective product postage and insurance prepaid to the address provided to you by the Metrobility Technical Support Representative. Failure to properly protect the product during shipping may void this warranty. The Metrobility RMA number must be clearly on the outside of the carton to ensure its acceptance.

Metrobility will pay return transportation for product repaired or replaced in-warranty. Before making any repair not covered by the warranty, Metrobility will estimate cost and obtain authorization, then invoice for repair and return transportation. Metrobility reserves the right to charge for all testing and shipping costs incurred, if test results determine that the unit is without defect.

This warranty constitutes the buyer's sole remedy. No other warranties, such as fitness for a particular purpose, are expressed or implied. Under no circumstances will Metrobility be liable for any damages incurred by the use of this product including, but not limited to, lost profits, lost savings, and incidental or consequential damages arising from the use of, or inability to use, this product. Authorized resellers are not authorized to extend any other warranty on Metrobility's behalf.

### **Product Manuals**

The most recent version of this manual is available online at  
<http://www.metrobility.com/support/manuals.htm>

### **Product Registration**

To register your product, go to  
<http://www.metrobility.com/support/registration.asp>

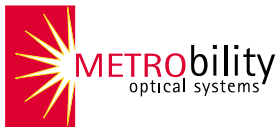

25 Manchester Street, Merrimack, NH 03054 USA  
tel: 1.603.880.1833 • fax: 1.603.594.2887  
[www.metrobility.com](http://www.metrobility.com)